

Randomised Algorithms

Lecture 8: Solving a TSP Instance using Linear Programming

Thomas Sauerwald (tms41@cam.ac.uk)

Lent 2024



Outline

Introduction

Examples of TSP Instances

Demonstration

The Traveling Salesman Problem (TSP)

*Given a set of **cities** along with the cost of travel between them, find the cheapest route visiting all cities and returning to your starting point.*

The Traveling Salesman Problem (TSP)

*Given a set of **cities** along with the cost of travel between them, find the cheapest route visiting all cities and returning to your starting point.*

Formal Definition



The Traveling Salesman Problem (TSP)

*Given a set of **cities** along with the cost of travel between them, find the cheapest route visiting all cities and returning to your starting point.*

Formal Definition

- **Given:** A complete undirected graph $G = (V, E)$ with nonnegative integer cost $c(u, v)$ for each edge $(u, v) \in E$

The Traveling Salesman Problem (TSP)

*Given a set of **cities** along with the cost of travel between them, find the cheapest route visiting all cities and returning to your starting point.*

Formal Definition

- **Given:** A complete undirected graph $G = (V, E)$ with nonnegative integer cost $c(u, v)$ for each edge $(u, v) \in E$
- **Goal:** Find a hamiltonian cycle of G with minimum cost.

The Traveling Salesman Problem (TSP)

Given a set of *cities* along with the cost of travel between them, find the cheapest route visiting all cities and returning to your starting point.

Formal Definition

- **Given:** A complete undirected graph $G = (V, E)$ with nonnegative integer cost $c(u, v)$ for each edge $(u, v) \in E$
- **Goal:** Find a hamiltonian cycle of G with minimum cost.

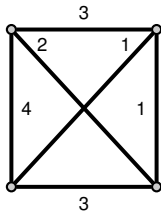

The Traveling Salesman Problem (TSP)

Given a set of *cities* along with the cost of travel between them, find the cheapest route visiting all cities and returning to your starting point.

Formal Definition

- **Given:** A complete undirected graph $G = (V, E)$ with nonnegative integer cost $c(u, v)$ for each edge $(u, v) \in E$
- **Goal:** Find a hamiltonian cycle of G with minimum cost.

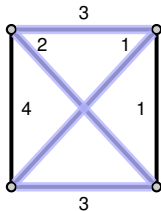

$$3 + 2 + 1 + 3 = 9$$

The Traveling Salesman Problem (TSP)

Given a set of *cities* along with the cost of travel between them, find the cheapest route visiting all cities and returning to your starting point.

Formal Definition

- **Given:** A complete undirected graph $G = (V, E)$ with nonnegative integer cost $c(u, v)$ for each edge $(u, v) \in E$
- **Goal:** Find a hamiltonian cycle of G with minimum cost.

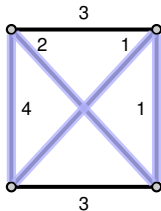

$$2 + 4 + 1 + 1 = 8$$

The Traveling Salesman Problem (TSP)

Given a set of *cities* along with the cost of travel between them, find the cheapest route visiting all cities and returning to your starting point.

Formal Definition

- **Given:** A complete undirected graph $G = (V, E)$ with nonnegative integer cost $c(u, v)$ for each edge $(u, v) \in E$
- **Goal:** Find a hamiltonian cycle of G with minimum cost.

Solution space consists of at most $n!$ possible tours!

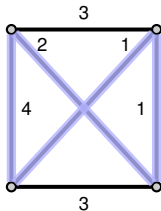

$$2 + 4 + 1 + 1 = 8$$

The Traveling Salesman Problem (TSP)

Given a set of *cities* along with the cost of travel between them, find the cheapest route visiting all cities and returning to your starting point.

Formal Definition

- **Given:** A complete undirected graph $G = (V, E)$ with nonnegative integer cost $c(u, v)$ for each edge $(u, v) \in E$
- **Goal:** Find a hamiltonian cycle of G with minimum cost.

Solution space consists of at most $n!$ possible tours!

Actually the right number is $(n - 1)!/2$

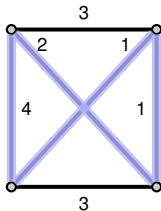

$$2 + 4 + 1 + 1 = 8$$

The Traveling Salesman Problem (TSP)

Given a set of *cities* along with the cost of travel between them, find the cheapest route visiting all cities and returning to your starting point.

Formal Definition

- **Given:** A complete undirected graph $G = (V, E)$ with nonnegative integer cost $c(u, v)$ for each edge $(u, v) \in E$
- **Goal:** Find a hamiltonian cycle of G with minimum cost.

Solution space consists of at most $n!$ possible tours!

Actually the right number is $(n - 1)!/2$

Special Instances

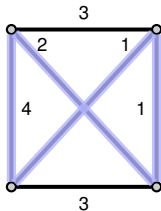

$$2 + 4 + 1 + 1 = 8$$

The Traveling Salesman Problem (TSP)

Given a set of *cities* along with the cost of travel between them, find the cheapest route visiting all cities and returning to your starting point.

Formal Definition

- **Given:** A complete undirected graph $G = (V, E)$ with nonnegative integer cost $c(u, v)$ for each edge $(u, v) \in E$
- **Goal:** Find a hamiltonian cycle of G with minimum cost.

Solution space consists of at most $n!$ possible tours!

Actually the right number is $(n - 1)!/2$

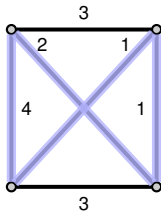

$$2 + 4 + 1 + 1 = 8$$

Special Instances

- **Metric TSP:** costs satisfy triangle inequality:

$$\forall u, v, w \in V: \quad c(u, w) \leq c(u, v) + c(v, w).$$

The Traveling Salesman Problem (TSP)

Given a set of *cities* along with the cost of travel between them, find the cheapest route visiting all cities and returning to your starting point.

Formal Definition

- **Given:** A complete undirected graph $G = (V, E)$ with nonnegative integer cost $c(u, v)$ for each edge $(u, v) \in E$
- **Goal:** Find a hamiltonian cycle of G with minimum cost.

Solution space consists of at most $n!$ possible tours!

Actually the right number is $(n - 1)!/2$

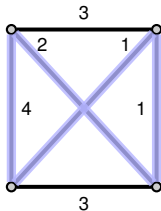

$$2 + 4 + 1 + 1 = 8$$

Special Instances

- **Metric TSP:** costs satisfy triangle inequality:

$$\forall u, v, w \in V: \quad c(u, w) \leq c(u, v) + c(v, w).$$

Even this version is NP hard (Ex. 35.2-2)

The Traveling Salesman Problem (TSP)

Given a set of *cities* along with the cost of travel between them, find the cheapest route visiting all cities and returning to your starting point.

Formal Definition

- **Given:** A complete undirected graph $G = (V, E)$ with nonnegative integer cost $c(u, v)$ for each edge $(u, v) \in E$
- **Goal:** Find a hamiltonian cycle of G with minimum cost.

Solution space consists of at most $n!$ possible tours!

Actually the right number is $(n - 1)!/2$

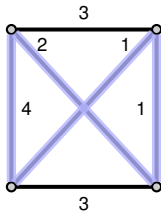

$$2 + 4 + 1 + 1 = 8$$

Special Instances

- **Metric TSP:** costs satisfy triangle inequality:

$$\forall u, v, w \in V: \quad c(u, w) \leq c(u, v) + c(v, w).$$

Even this version is NP hard (Ex. 35.2-2)

- **Euclidean TSP:** cities are points in the Euclidean space, costs are equal to their (rounded) Euclidean distance

Outline

Introduction

Examples of TSP Instances

Demonstration

33 city contest (1964)

HELP! WE'RE LOST!

HELP "CAR 54"... AND WIN CASH
54...\$1,000 PRIZES
ONE...\$10,000 GRAND PRIZE

START and FINISH

Map by Rand McNally

Help Toody and Muldoon find the shortest round trip route to visit all 33 locations shown on the map.
All you do is draw connecting straight lines from location to location to show the shortest round trip route.

HERE'S THE CORRECT START...
Begin at Chicago, Illinois. From there, lines show correct route as far as Erie, Pennsylvania. Next, do you go to Carlisle, Pennsylvania or Wana, West Virginia? Check the easy instructions on back of this entry blank for details.

© PROCTER & GAMBLE 1962

OFFICIAL RULES ON REVERSE SIDE

532 cities (1987 [Padberg, Rinaldi])

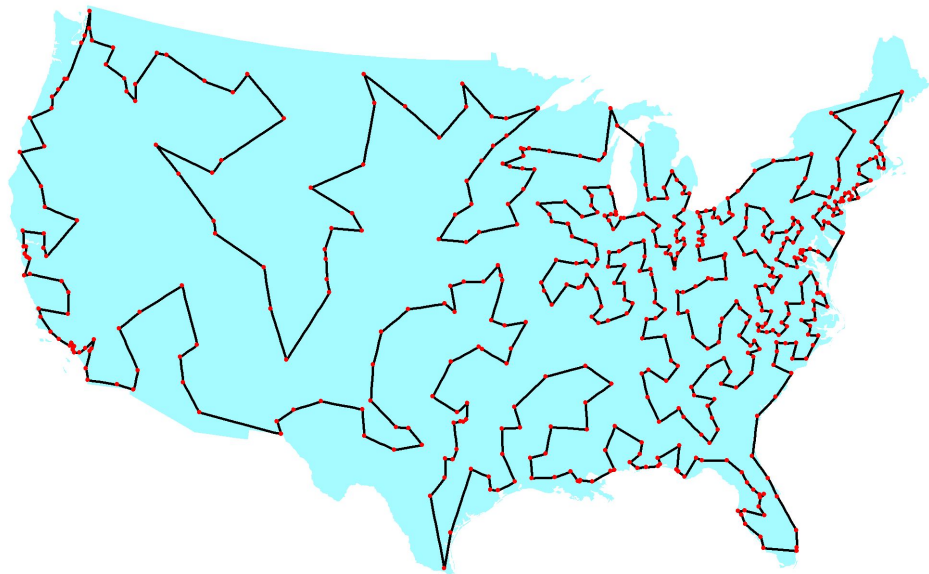

13,509 cities (1999 [Applegate, Bixby, Chavatal, Cook])

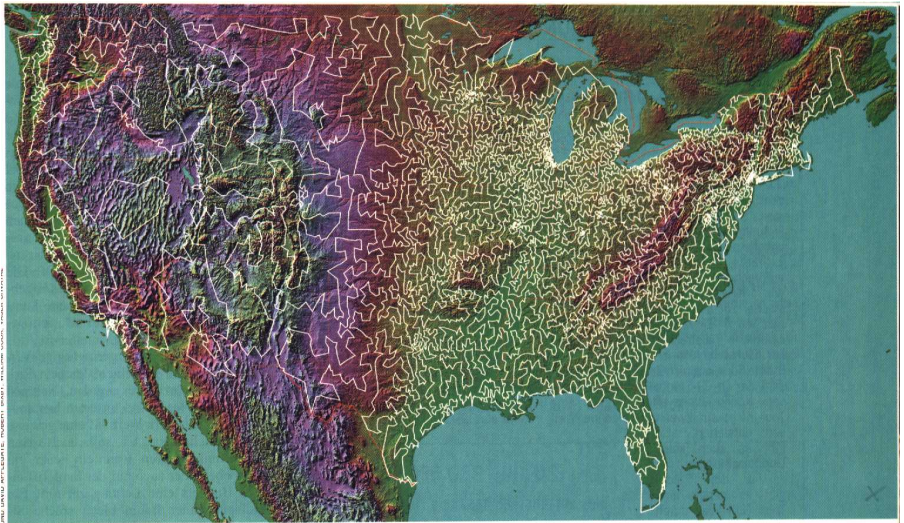

UNITED STATES GEOLOGICAL SURVEY, TERRAIN SHADER, 1:250,000, SOURCE: NATIONAL CENTER FOR GEOGRAPHIC INFORMATION

SOLUTION OF A LARGE-SCALE TRAVELING-SALESMAN PROBLEM*

G. DANTZIG, R. FULKERSON, AND S. JOHNSON

The Rand Corporation, Santa Monica, California

(Received August 9, 1954)

It is shown that a certain tour of 49 cities, one in each of the 48 states and Washington, D. C., has the shortest road distance.

THE TRAVELING-SALESMAN PROBLEM might be described as follows: Find the shortest route (tour) for a salesman starting from a given city, visiting each of a specified group of cities, and then returning to the original point of departure. More generally, given an n by n symmetric matrix $D=(d_{IJ})$, where d_{IJ} represents the 'distance' from I to J , arrange the points in a cyclic order in such a way that the sum of the d_{IJ} between consecutive points is minimal. Since there are only a finite number of possibilities (at most $\frac{1}{2}(n-1)!$) to consider, the problem is to devise a method of picking out the optimal arrangement which is reasonably efficient for fairly large values of n . Although algorithms have been devised for problems of similar nature, e.g., the optimal assignment problem,^{3,7,8} little is known about the traveling-salesman problem. We do not claim that this note alters the situation very much; what we shall do is outline a way of approaching the problem that sometimes, at least, enables one to find an optimal path and prove it so. In particular, it will be shown that a certain arrangement of 49 cities, one in each of the 48 states and Washington, D. C., is best, the d_{IJ} used representing road distances as taken from an atlas.

The 42 (49) Cities

1. Manchester, N. H.
2. Montpelier, Vt.
3. Detroit, Mich.
4. Cleveland, Ohio
5. Charleston, W. Va.
6. Louisville, Ky.
7. Indianapolis, Ind.
8. Chicago, Ill.
9. Milwaukee, Wis.
10. Minneapolis, Minn.
11. Pierre, S. D.
12. Bismarck, N. D.
13. Helena, Mont.
14. Seattle, Wash.
15. Portland, Ore.
16. Boise, Idaho
17. Salt Lake City, Utah
18. Carson City, Nev.
19. Los Angeles, Calif.
20. Phoenix, Ariz.
21. Santa Fe, N. M.
22. Denver, Colo.
23. Cheyenne, Wyo.
24. Omaha, Neb.
25. Des Moines, Iowa
26. Kansas City, Mo.
27. Topeka, Kans.
28. Oklahoma City, Okla.
29. Dallas, Tex.
30. Little Rock, Ark.
31. Memphis, Tenn.
32. Jackson, Miss.
33. New Orleans, La.
34. Birmingham, Ala.
35. Atlanta, Ga.
36. Jacksonville, Fla.
37. Columbia, S. C.
38. Raleigh, N. C.
39. Richmond, Va.
40. Washington, D. C.
41. Boston, Mass.
42. Portland, Me.
- A. Baltimore, Md.
- B. Wilmington, Del.
- C. Philadelphia, Penn.
- D. Newark, N. J.
- E. New York, N. Y.
- F. Hartford, Conn.
- G. Providence, R. I.

Combinatorial Explosion



(42-1)!/2

NATURAL LANGUAGE MATH INPUT EXTENDED KEYBOARD EXAMPLES UPLOAD RANDOM

Input

$$\frac{1}{2} (42 - 1)!$$

n! is the factorial function

Result

1672626330658190355408503102672037583257600000000

Scientific notation

$$1.6726263306581903554085031026720375832576 \times 10^{49}$$

Number name [Full name](#)

16 quindillion ...

Number length

50 decimal digits

Alternative representations [More](#)

$$\frac{1}{2} (42 - 1)! = \frac{\Gamma(42)}{2}$$
$$\frac{1}{2} (42 - 1)! = \frac{\Gamma(42, 0)}{2}$$
$$\frac{1}{2} (42 - 1)! = \frac{(1)_{41}}{2}$$

Solution of this TSP problem

Dantzig, Fulkerson and Johnson found an optimal tour through 42 cities.

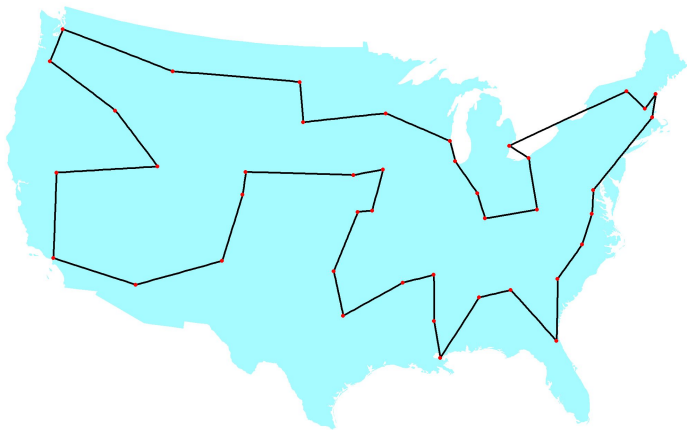

http://www.math.uwaterloo.ca/tsp/history/img/dantzig_big.html

Modelling TSP as a Linear Program Relaxation

Idea: Indicator variable $x(i, j)$, $i > j$, which is one if the tour includes edge $\{i, j\}$ (in either direction)

Modelling TSP as a Linear Program Relaxation

Idea: Indicator variable $x(i, j)$, $i > j$, which is one if the tour includes edge $\{i, j\}$ (in either direction)

minimize $\sum_{i=1}^{42} \sum_{j=1}^{i-1} c(i, j)x(i, j)$

subject to

$$\begin{aligned} \sum_{j < i} x(i, j) + \sum_{j > i} x(j, i) &= 2 && \text{for each } 1 \leq i \leq 42 \\ 0 \leq x(i, j) &\leq 1 && \text{for each } 1 \leq j < i \leq 42 \end{aligned}$$

Modelling TSP as a Linear Program Relaxation

Idea: Indicator variable $x(i, j)$, $i > j$, which is one if the tour includes edge $\{i, j\}$ (in either direction)

minimize
$$\sum_{i=1}^{42} \sum_{j=1}^{i-1} c(i, j)x(i, j)$$

subject to

$$\begin{aligned} \sum_{j < i} x(i, j) + \sum_{j > i} x(j, i) &= 2 && \text{for each } 1 \leq i \leq 42 \\ 0 \leq x(i, j) \leq 1 &&& \text{for each } 1 \leq j < i \leq 42 \end{aligned}$$

Constraints $x(i, j) \in \{0, 1\}$ are not allowed in a LP!

Modelling TSP as a Linear Program Relaxation

Idea: Indicator variable $x(i, j)$, $i > j$, which is one if the tour includes edge $\{i, j\}$ (in either direction)

minimize $\sum_{i=1}^{42} \sum_{j=1}^{i-1} c(i, j)x(i, j)$

subject to

$$\sum_{j < i} x(i, j) + \sum_{j > i} x(j, i) = 2 \quad \text{for each } 1 \leq i \leq 42$$
$$0 \leq x(i, j) \leq 1 \quad \text{for each } 1 \leq j < i \leq 42$$

Constraints $x(i, j) \in \{0, 1\}$ are not allowed in a LP!

Branch & Bound to solve an Integer Program:

Modelling TSP as a Linear Program Relaxation

Idea: Indicator variable $x(i, j)$, $i > j$, which is one if the tour includes edge $\{i, j\}$ (in either direction)

minimize $\sum_{i=1}^{42} \sum_{j=1}^{i-1} c(i, j)x(i, j)$

subject to

$$\sum_{j < i} x(i, j) + \sum_{j > i} x(j, i) = 2 \quad \text{for each } 1 \leq i \leq 42$$
$$0 \leq x(i, j) \leq 1 \quad \text{for each } 1 \leq j < i \leq 42$$

Constraints $x(i, j) \in \{0, 1\}$ are not allowed in a LP!

Branch & Bound to solve an Integer Program:

- As long as solution of LP has fractional $x(i, j) \in (0, 1)$:

Modelling TSP as a Linear Program Relaxation

Idea: Indicator variable $x(i, j)$, $i > j$, which is one if the tour includes edge $\{i, j\}$ (in either direction)

minimize
$$\sum_{i=1}^{42} \sum_{j=1}^{i-1} c(i, j)x(i, j)$$

subject to

$$\sum_{j < i} x(i, j) + \sum_{j > i} x(j, i) = 2 \quad \text{for each } 1 \leq i \leq 42$$
$$0 \leq x(i, j) \leq 1 \quad \text{for each } 1 \leq j < i \leq 42$$

Constraints $x(i, j) \in \{0, 1\}$ are not allowed in a LP!

Branch & Bound to solve an Integer Program:

- As long as solution of LP has fractional $x(i, j) \in (0, 1)$:
 - Add $x(i, j) = 0$ to the LP, solve it and recurse
 - Add $x(i, j) = 1$ to the LP, solve it and recurse
 - Return best of these two solutions

Modelling TSP as a Linear Program Relaxation

Idea: Indicator variable $x(i, j)$, $i > j$, which is one if the tour includes edge $\{i, j\}$ (in either direction)

minimize
$$\sum_{i=1}^{42} \sum_{j=1}^{i-1} c(i, j)x(i, j)$$

subject to

$$\sum_{j < i} x(i, j) + \sum_{j > i} x(j, i) = 2 \quad \text{for each } 1 \leq i \leq 42$$
$$0 \leq x(i, j) \leq 1 \quad \text{for each } 1 \leq j < i \leq 42$$

Constraints $x(i, j) \in \{0, 1\}$ are not allowed in a LP!

Branch & Bound to solve an Integer Program:

- As long as solution of LP has fractional $x(i, j) \in (0, 1)$:
 - Add $x(i, j) = 0$ to the LP, solve it and recurse
 - Add $x(i, j) = 1$ to the LP, solve it and recurse
 - Return best of these two solutions
- If solution of LP integral, return objective value

Modelling TSP as a Linear Program Relaxation

Idea: Indicator variable $x(i, j)$, $i > j$, which is one if the tour includes edge $\{i, j\}$ (in either direction)

minimize $\sum_{i=1}^{42} \sum_{j=1}^{i-1} c(i, j)x(i, j)$

subject to

$$\sum_{j < i} x(i, j) + \sum_{j > i} x(j, i) = 2 \quad \text{for each } 1 \leq i \leq 42$$
$$0 \leq x(i, j) \leq 1 \quad \text{for each } 1 \leq j < i \leq 42$$

Constraints $x(i, j) \in \{0, 1\}$ are not allowed in a LP!

Branch & Bound to solve an Integer Program:

- As long as solution of LP has fractional $x(i, j) \in (0, 1)$:
 - Add $x(i, j) = 0$ to the LP, solve it and recurse
 - Add $x(i, j) = 1$ to the LP, solve it and recurse
 - Return best of these two solutions
- If solution of LP integral, return objective value

Bound-Step: If the best known integral solution so far is better than the solution of a LP, no need to explore branch further!

Outline

Introduction

Examples of TSP Instances

Demonstration

In the following, there are a few different runs of the demo.

Iteration 1:

Objective value: -641.000000 , 861 variables, 945 constraints, 1809 iterations

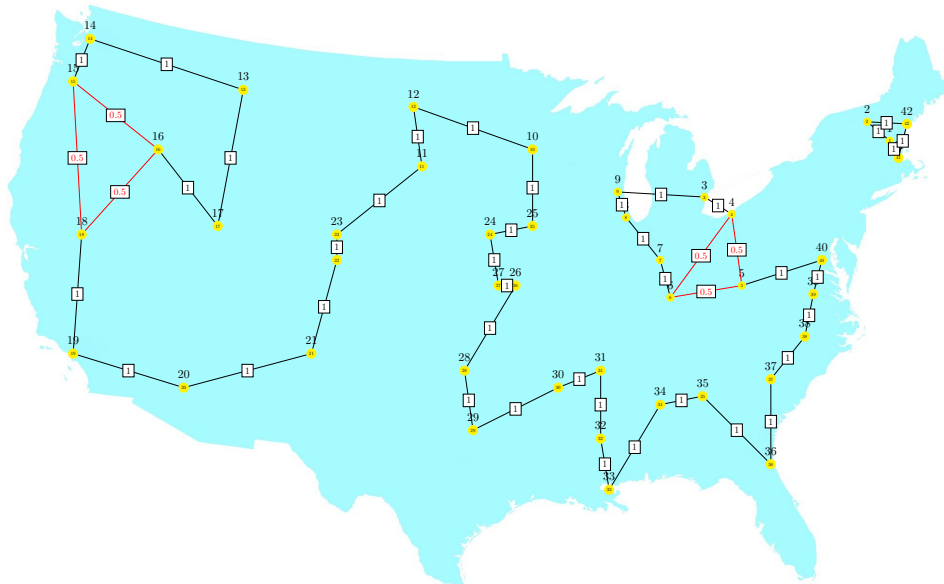

Iteration 1: Eliminate Subtour 1, 2, 41, 42

Objective value: -641.000000 , 861 variables, 945 constraints, 1809 iterations

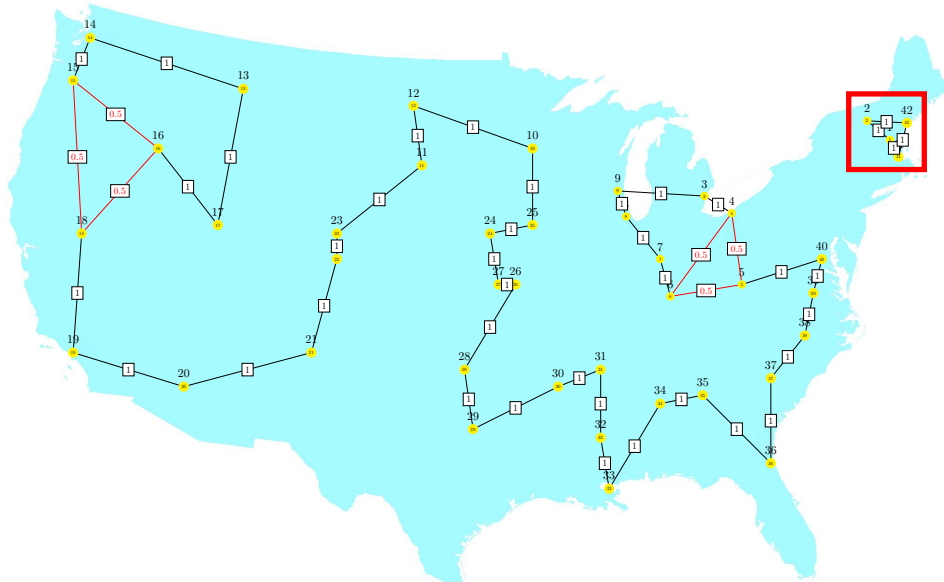

Iteration 1: Eliminate Subtour 1, 2, 41, 42

Objective value: -641.000000 , 861 variables, 945 constraints, 1809 iterations

Disallow subtour (1, 2, 42, 41) by adding this constraint to the LP:

$$x(2, 1) + x(41, 1) + x(42, 1) + x(41, 2) + x(42, 2) + x(42, 41) \leq 3$$

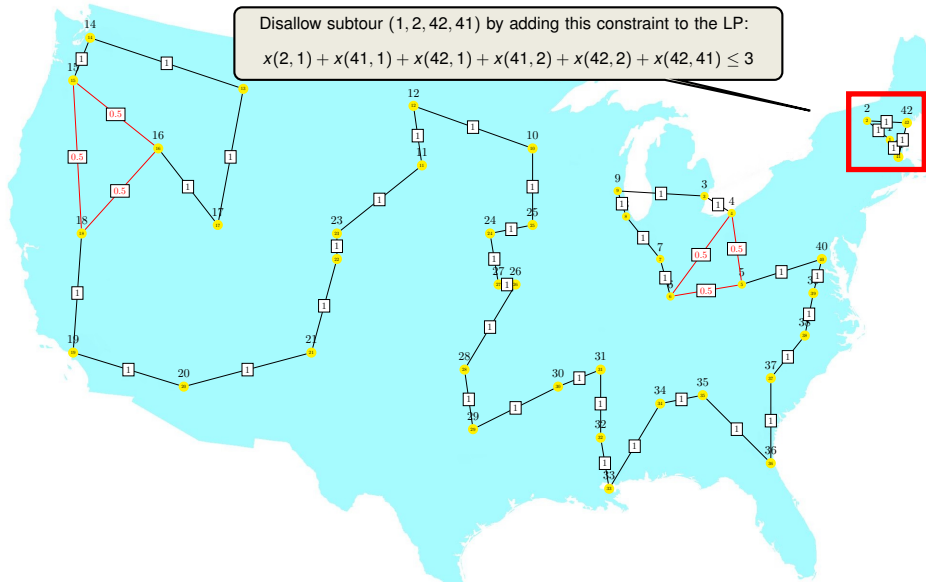

Iteration 1: Eliminate Subtour 1, 2, 41, 42

Objective value: -641.000000 , 861 variables, 945 constraints, 1809 iterations

Disallow subtour (1, 2, 42, 41) by adding this constraint to the LP:

$$x(2, 1) + x(41, 1) + x(42, 1) + x(41, 2) + x(42, 2) + x(42, 41) \leq 3$$

Equivalent to: $S = \{1, 2, 41, 42\}$,

$$\sum_{i \in S, j \in V \setminus S} x(\max(i, j), \min(i, j)) \geq 2$$



Iteration 2:

Objective value: -676.000000 , 861 variables, 946 constraints, 1802 iterations

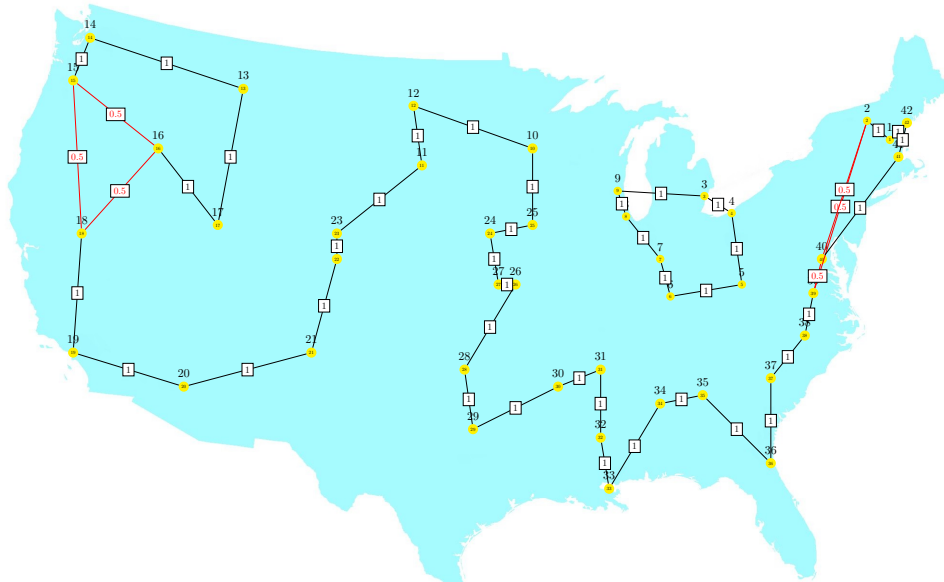

Iteration 2: Eliminate Subtour 3 – 9

Objective value: -676.000000 , 861 variables, 946 constraints, 1802 iterations

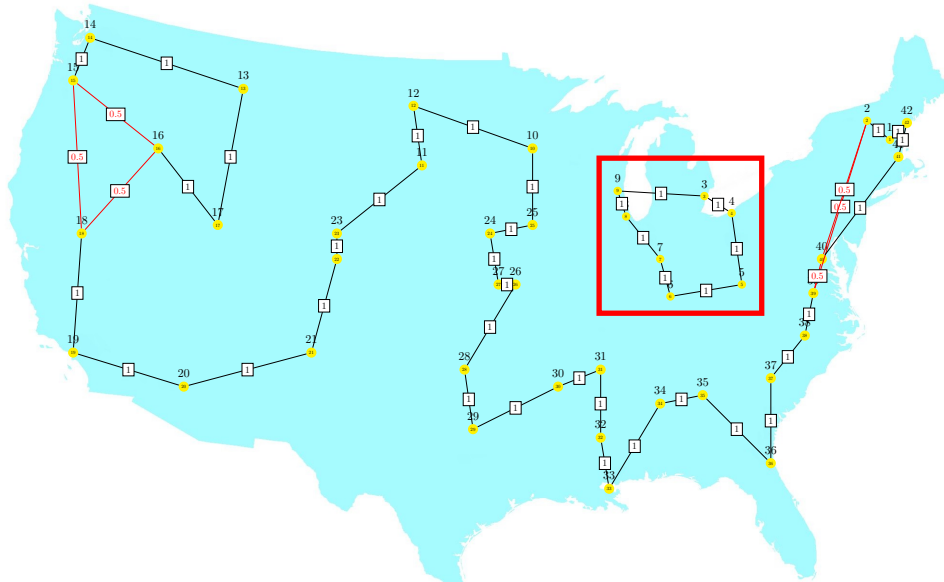

Iteration 3:

Objective value: -681.000000 , 861 variables, 947 constraints, 1984 iterations

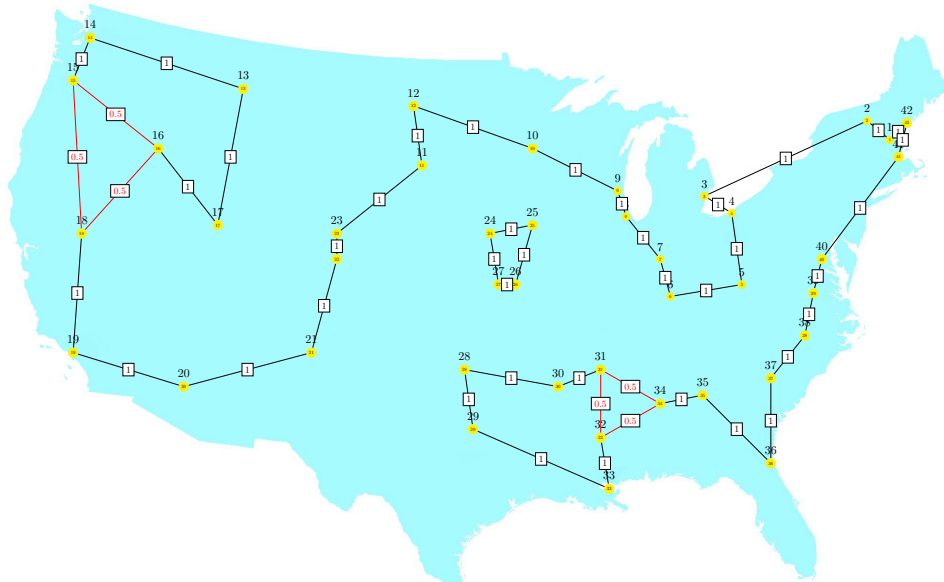

Iteration 3: Eliminate Subtour 24, 25, 26, 27

Objective value: -681.000000 , 861 variables, 947 constraints, 1984 iterations

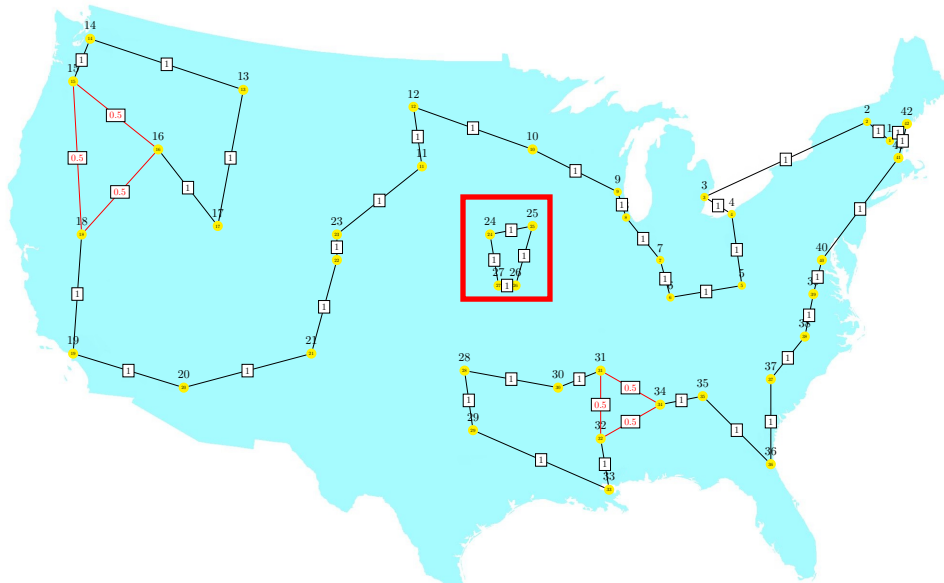

Iteration 4:

Objective value: -682.500000 , 861 variables, 948 constraints, 1492 iterations

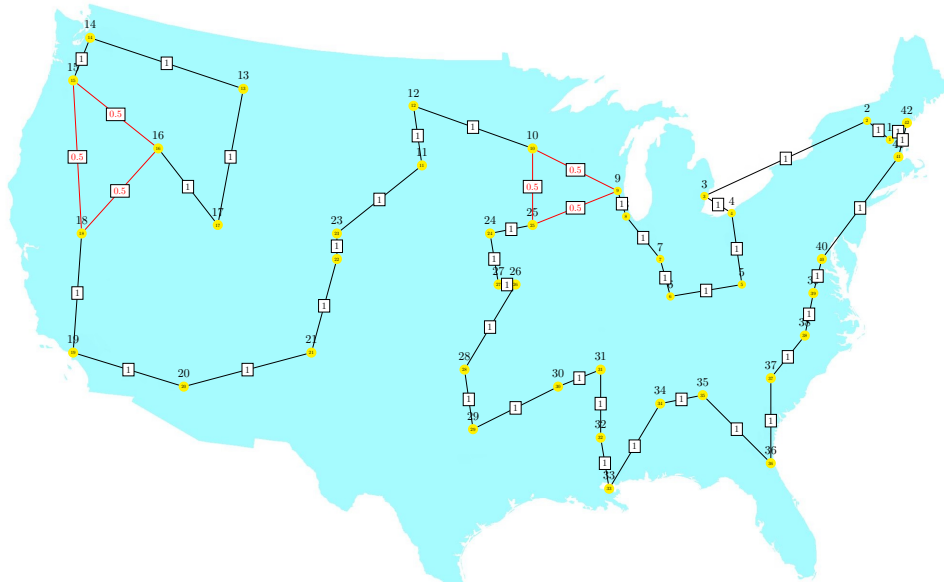

Iteration 4: Eliminate Cut 11 – 23

Objective value: -682.500000 , 861 variables, 948 constraints, 1492 iterations

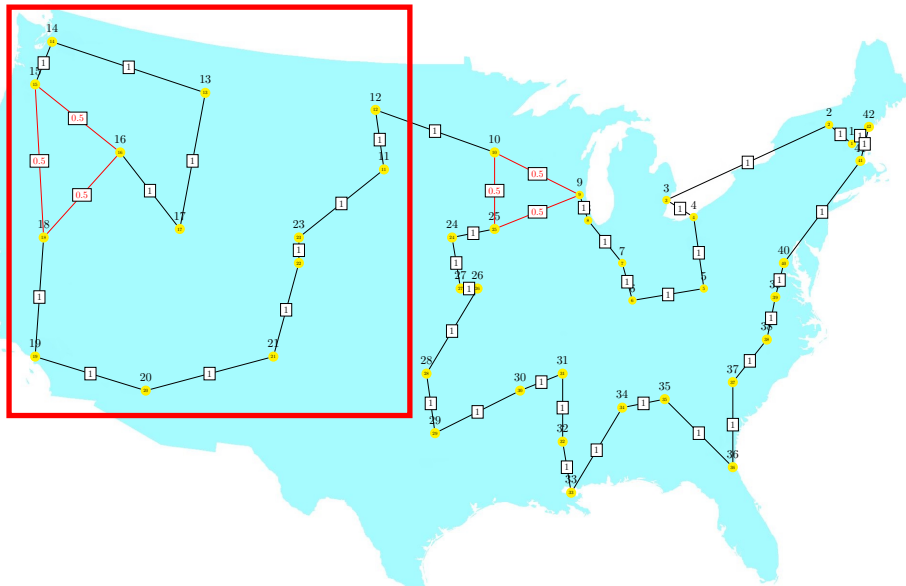

Iteration 4: Eliminate Cut 11 – 23

Objective value: -682.500000 , 861 variables, 948 constraints, 1492 iterations

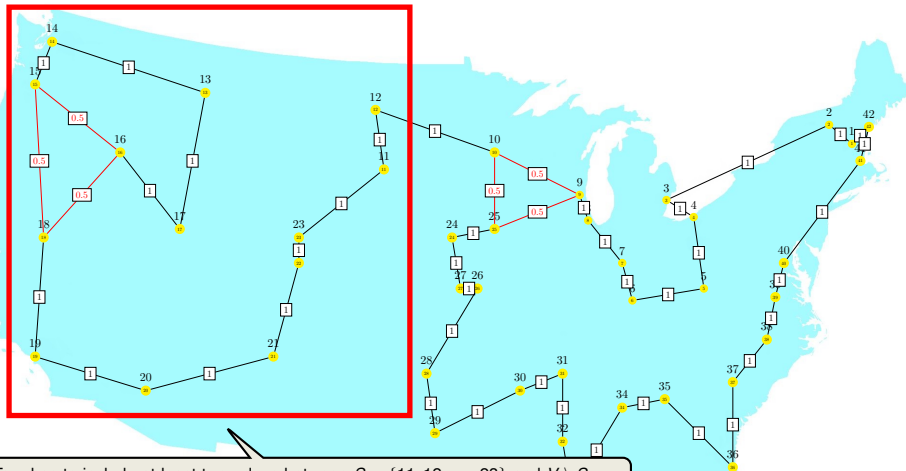

Tour has to include at least two edges between $S = \{11, 12, \dots, 23\}$ and $V \setminus S$:

$$\sum_{i \in S, j \in V \setminus S} x(\max(i, j), \min(i, j)) \geq 2.$$

Iteration 5:

Objective value: -686.000000 , 861 variables, 949 constraints, 2446 iterations

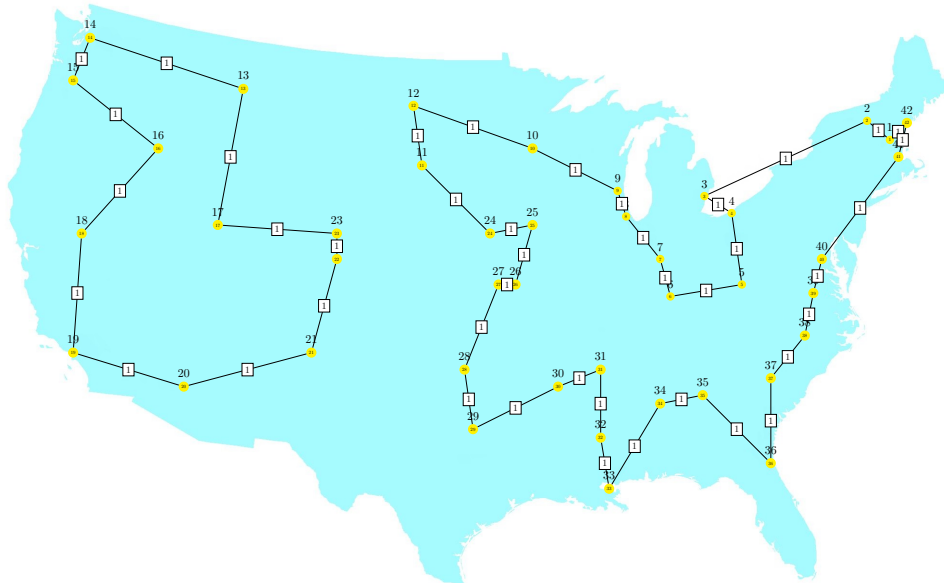

Iteration 5: Eliminate Subtour 13 – 23

Objective value: -686.000000 , 861 variables, 949 constraints, 2446 iterations

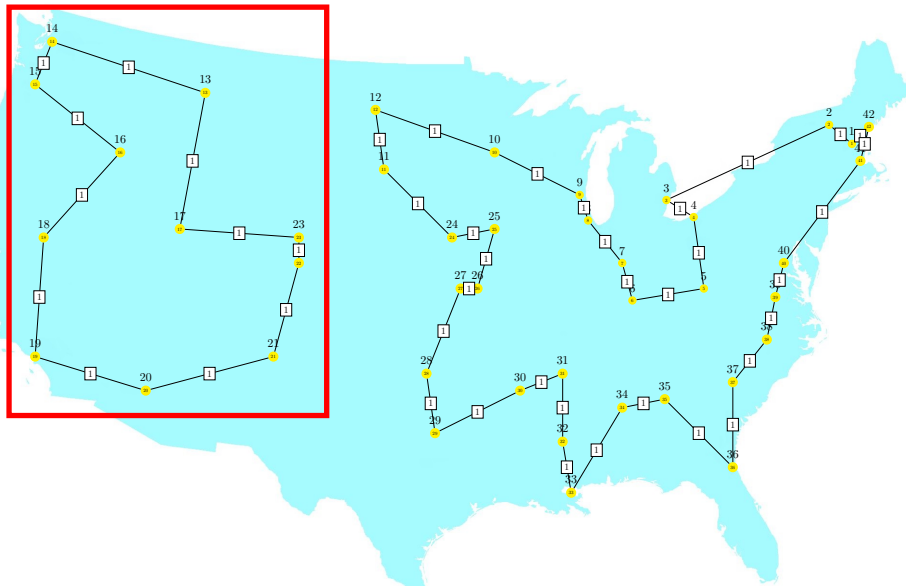

Iteration 6:

Objective value: -694.500000 , 861 variables, 950 constraints, 1690 iterations

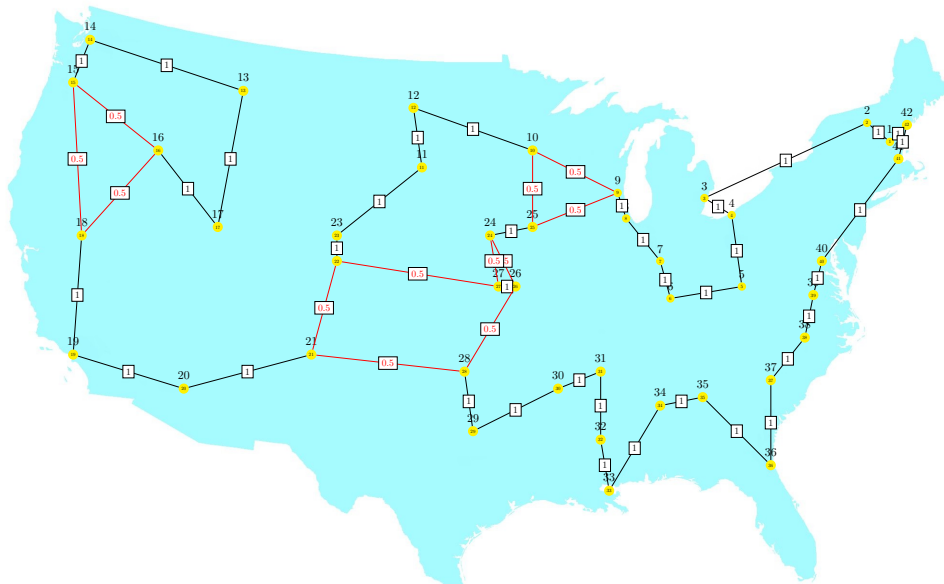

Iteration 6: Eliminate Cut 13 – 17

Objective value: -694.500000 , 861 variables, 950 constraints, 1690 iterations

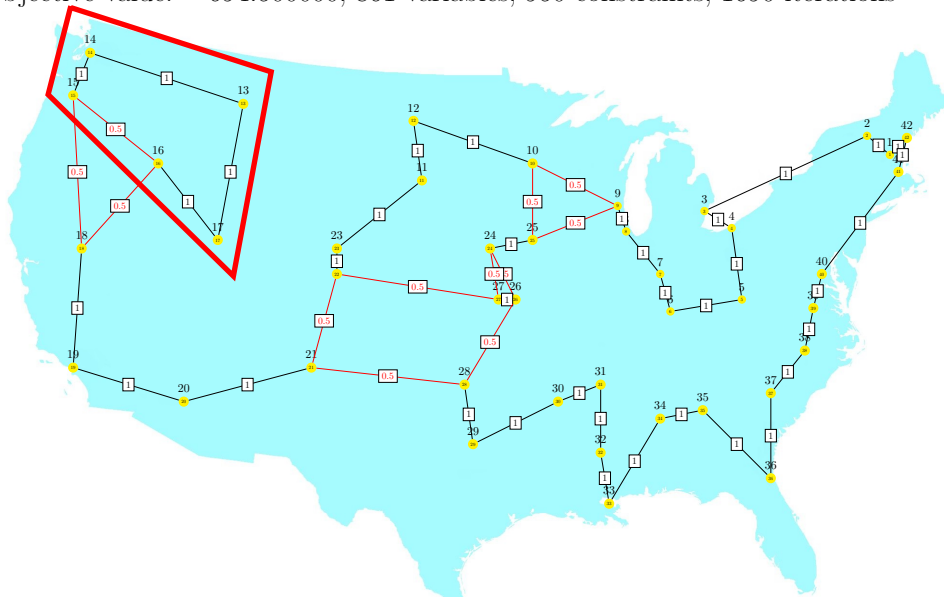

Iteration 7:

Objective value: -697.000000 , 861 variables, 951 constraints, 2212 iterations

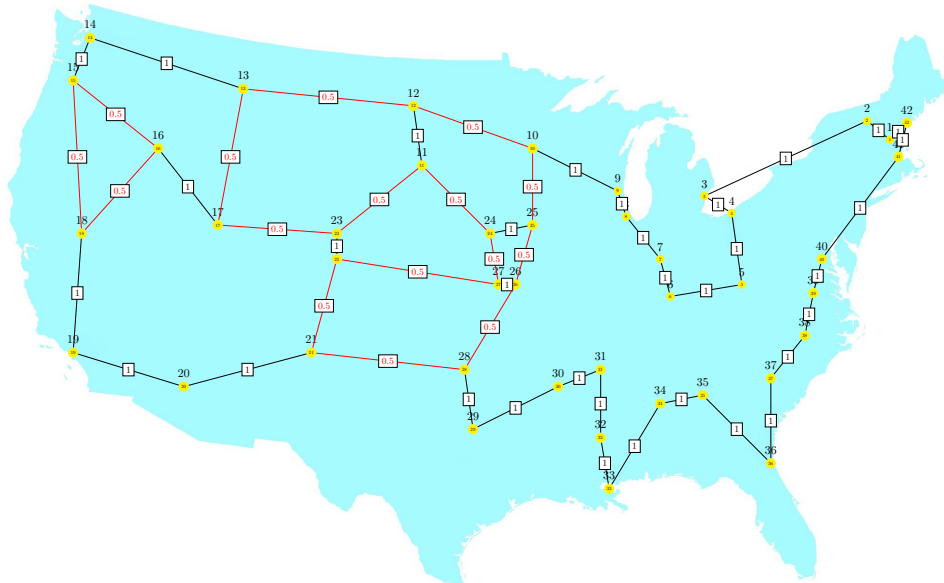

Iteration 7: Branch 1a $x_{18,15} = 0$

Objective value: -697.000000 , 861 variables, 951 constraints, 2212 iterations

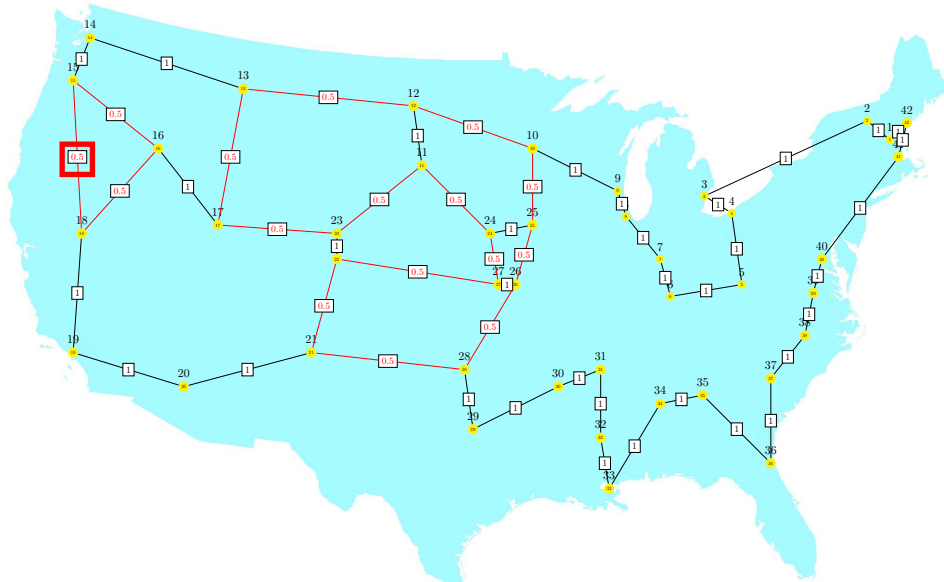

Iteration 8:

Objective value: -698.000000 , 861 variables, 952 constraints, 1878 iterations

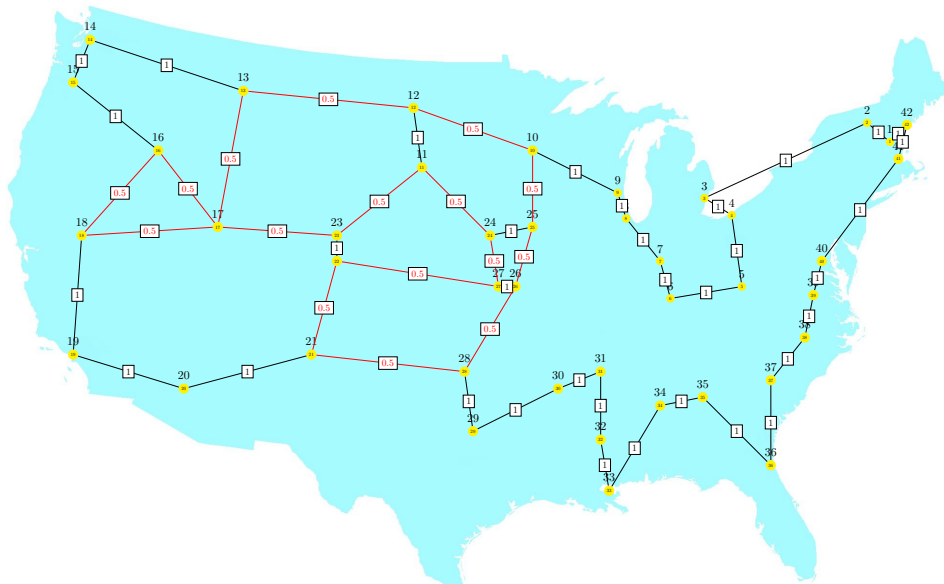

Iteration 8: Branch 2a $x_{17,13} = 0$

Objective value: -698.000000 , 861 variables, 952 constraints, 1878 iterations

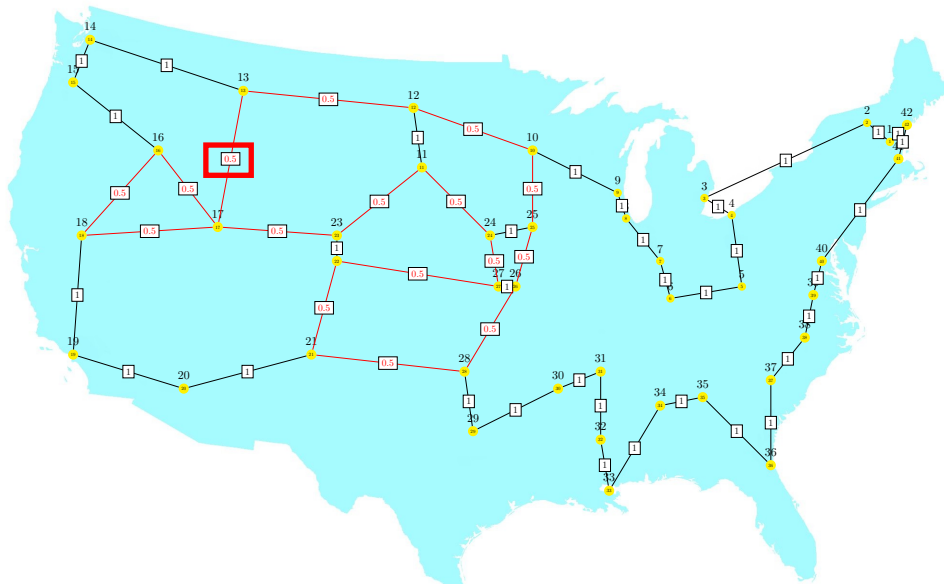

Iteration 9:

Objective value: -699.000000 , 861 variables, 953 constraints, 2281 iterations

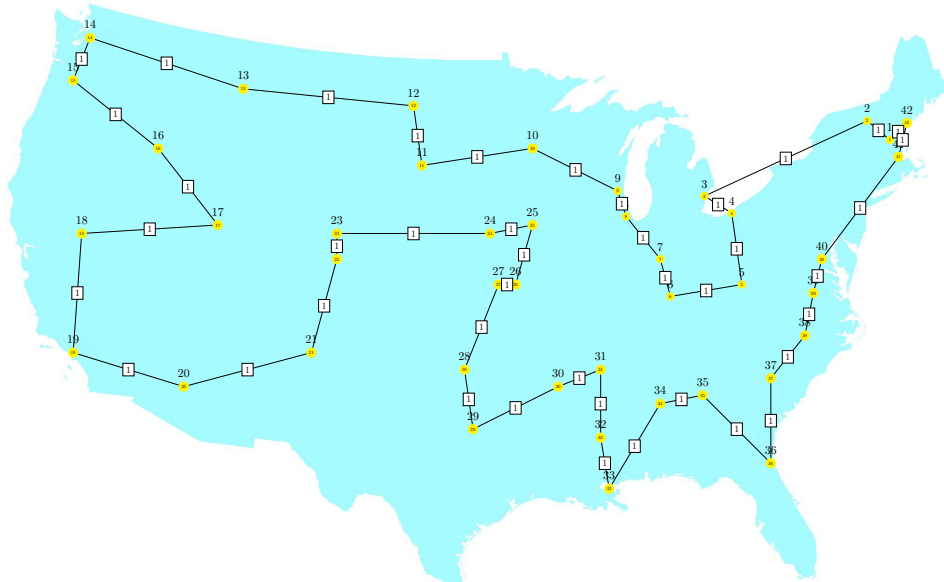

Iteration 9: Branch 2b $x_{17,13} = 1$

Objective value: -699.000000 , 861 variables, 953 constraints, 2281 iterations

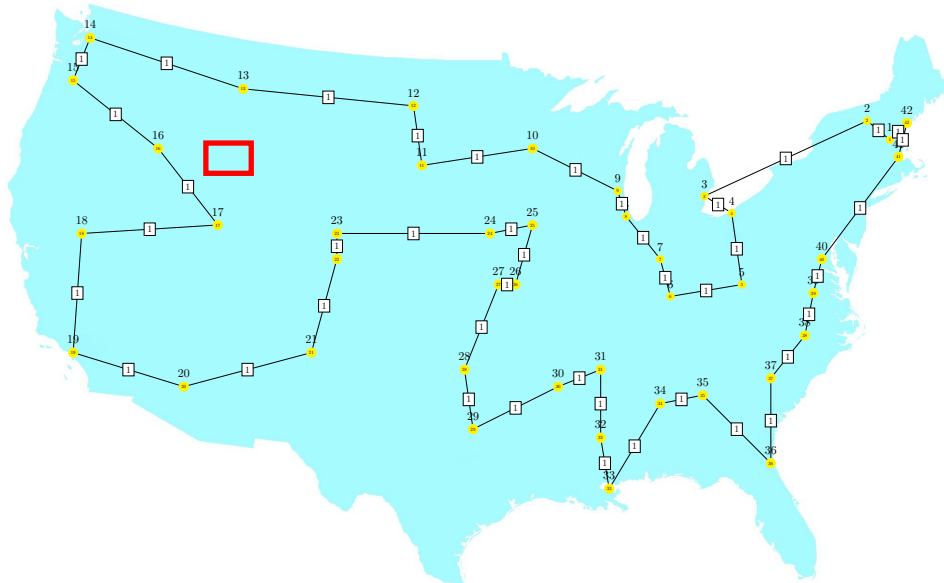

Iteration 10:

Objective value: -700.000000 , 861 variables, 954 constraints, 2398 iterations

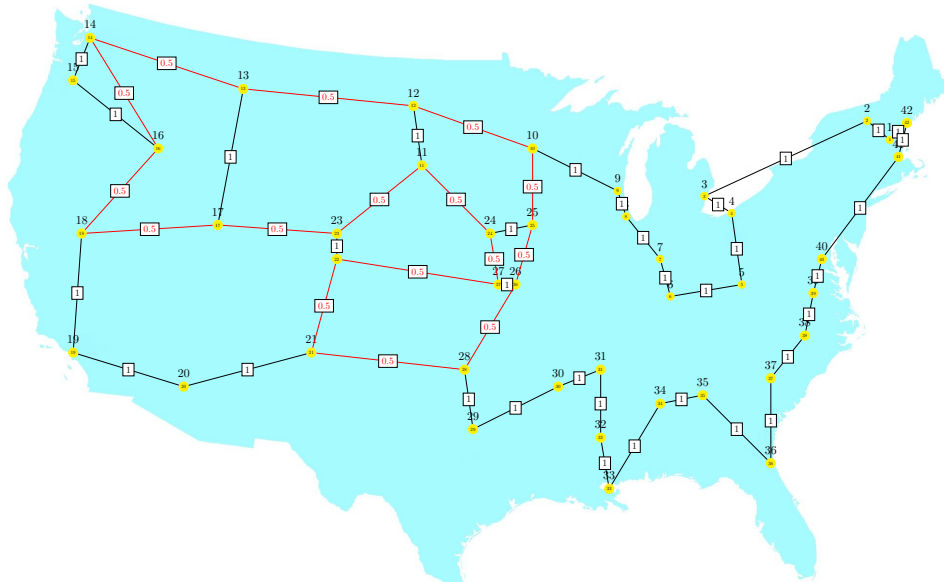

Iteration 10:

Objective value: -700.000000 , 861 variables, 954 constraints, 2398 iterations

Branch & Bound procedure would stop here, since value of the best LP solution for $x_{18,15} = 0$ is worse than a previously found tour.

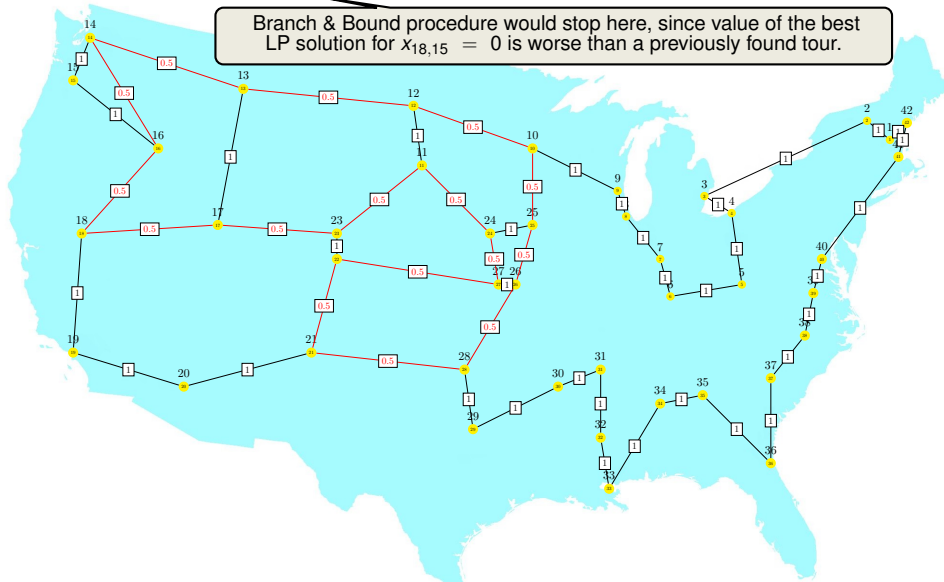

Iteration 10: Branch 1b $x_{18,15} = 1$

Objective value: -700.000000 , 861 variables, 954 constraints, 2398 iterations

Branch & Bound procedure would stop here, since value of the best LP solution for $x_{18,15} = 0$ is worse than a previously found tour.

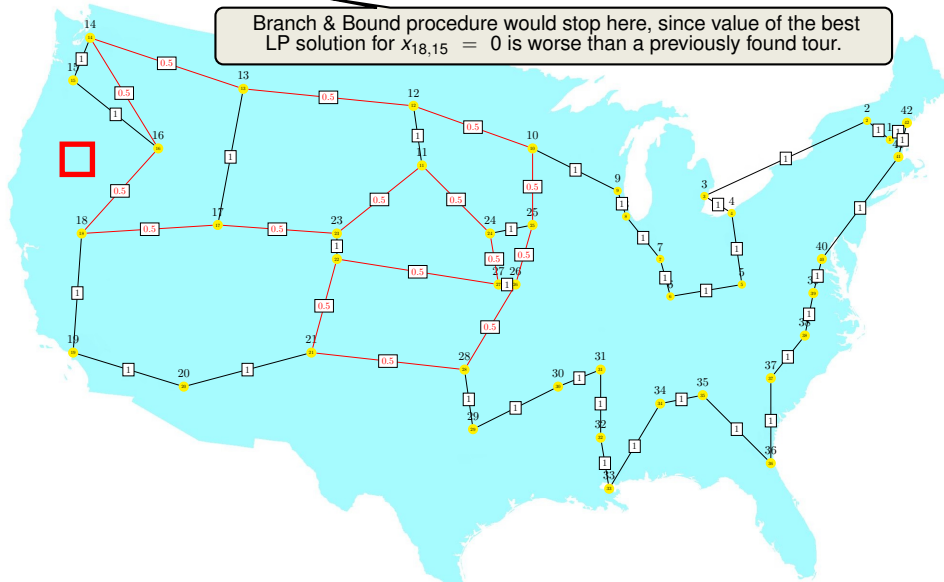

Iteration 11:

Objective value: -701.000000 , 861 variables, 953 constraints, 2506 iterations

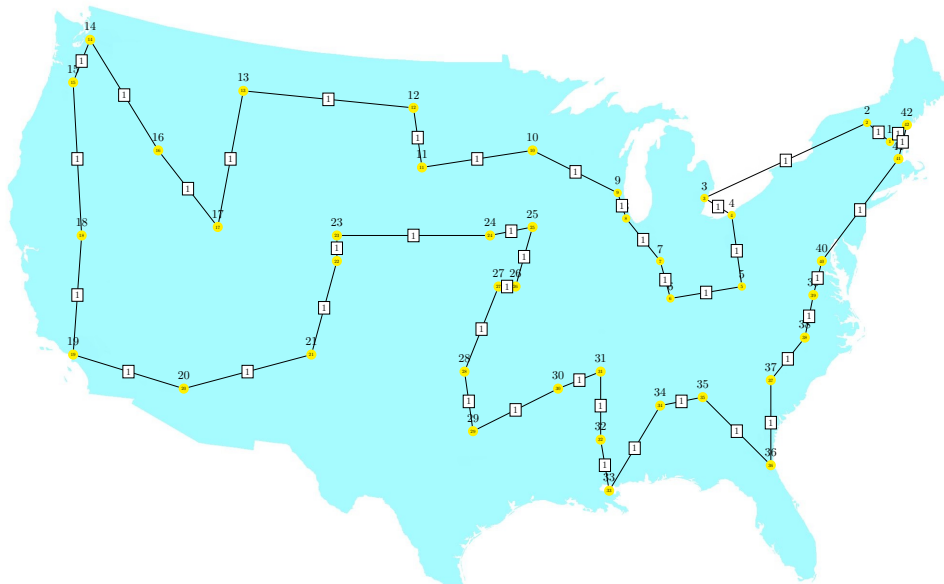

Iteration 11: Branch & Bound terminates

Objective value: -701.000000 , 861 variables, 953 constraints, 2506 iterations

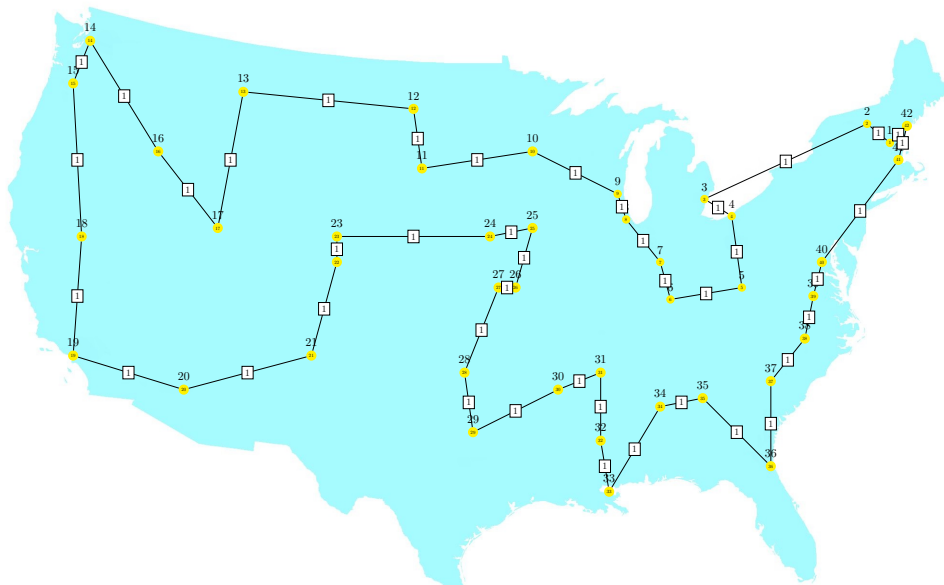

Branch & Bound Overview

1: LP solution 641

Branch & Bound Overview

1: LP solution 641



Eliminate Subtour 1, 2, 41, 42

Branch & Bound Overview

1: LP solution 641



Eliminate Subtour 1, 2, 41, 42

2: LP solution 676

Branch & Bound Overview

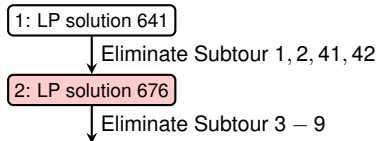

Branch & Bound Overview

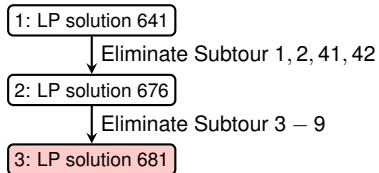

Branch & Bound Overview

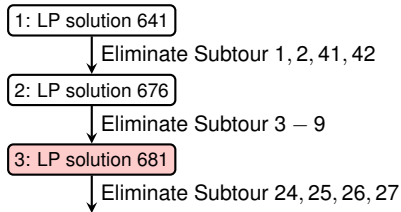

Branch & Bound Overview

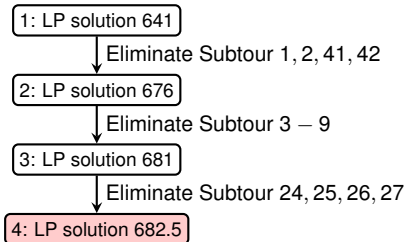

Branch & Bound Overview

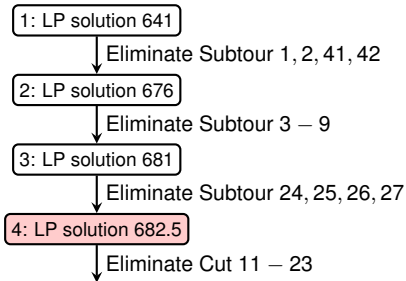

Branch & Bound Overview

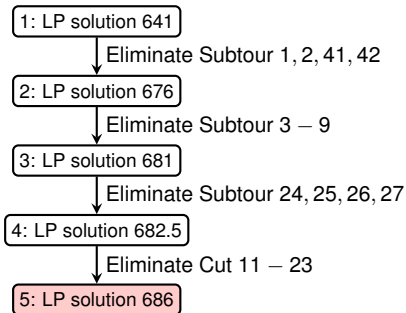

Branch & Bound Overview

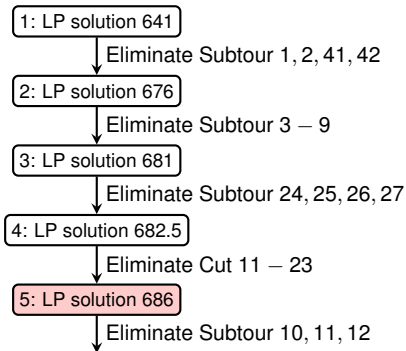

Branch & Bound Overview

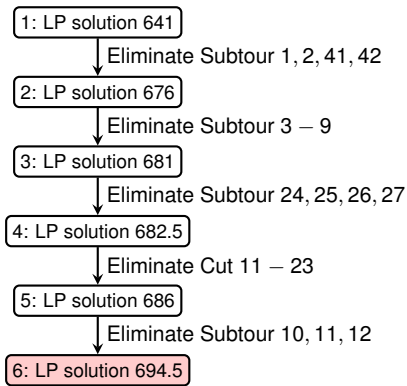

Branch & Bound Overview

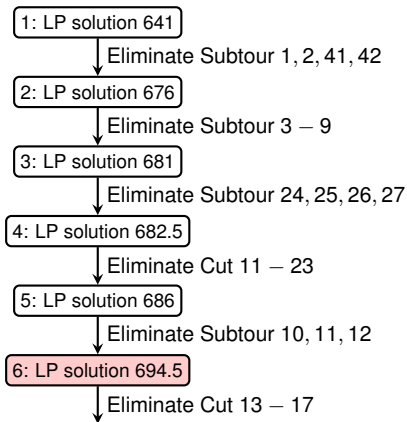

Branch & Bound Overview

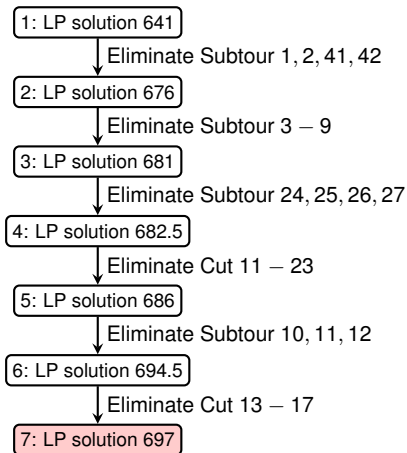

Branch & Bound Overview

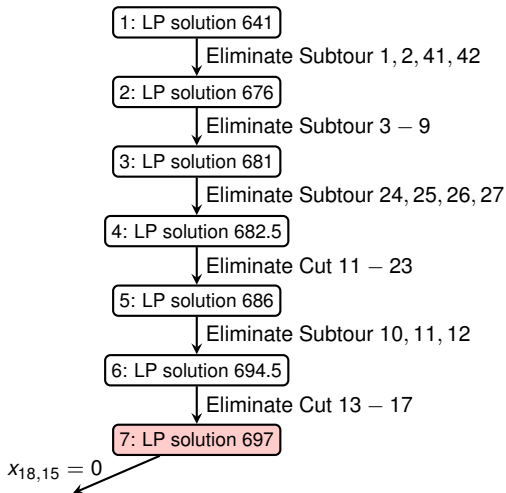

Branch & Bound Overview

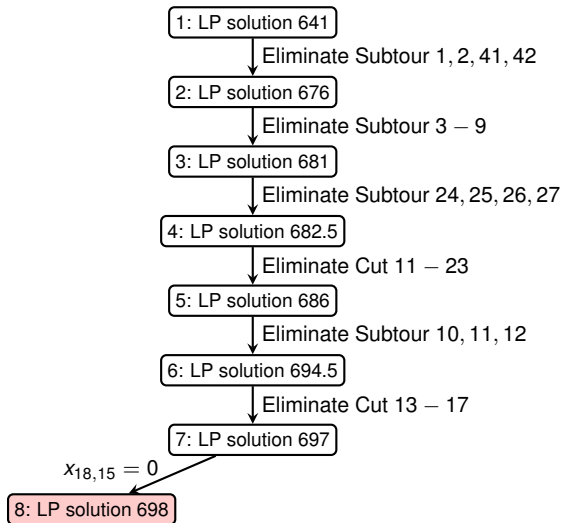

Branch & Bound Overview

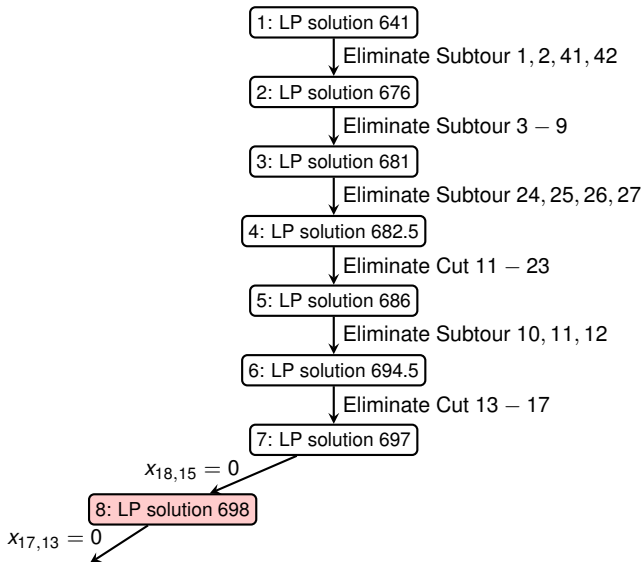

Branch & Bound Overview

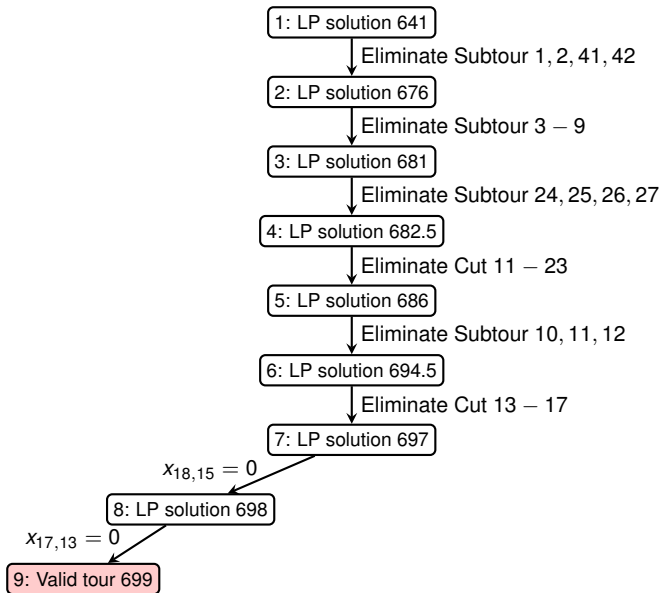

Branch & Bound Overview

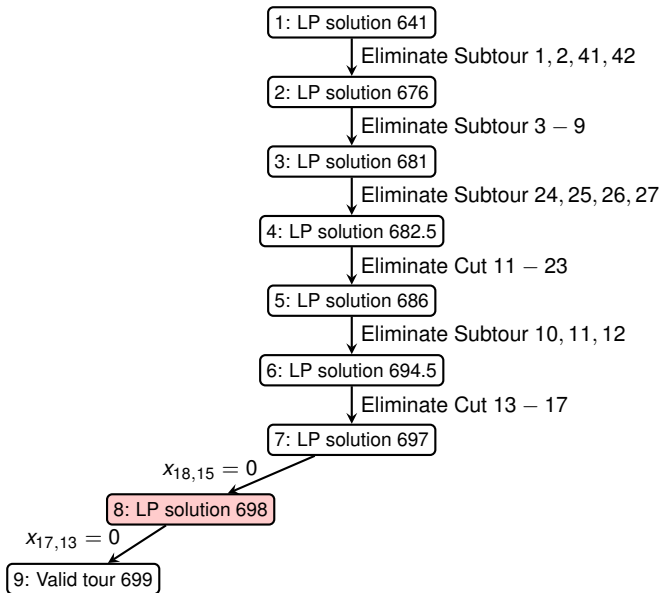

Branch & Bound Overview

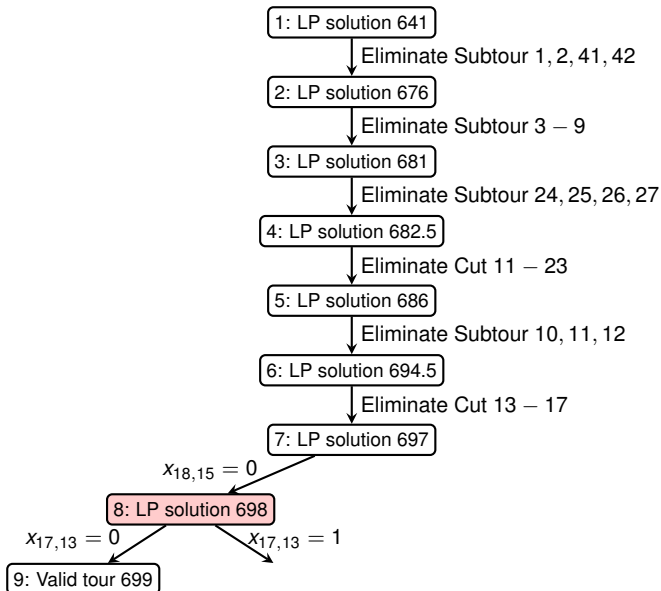

Branch & Bound Overview

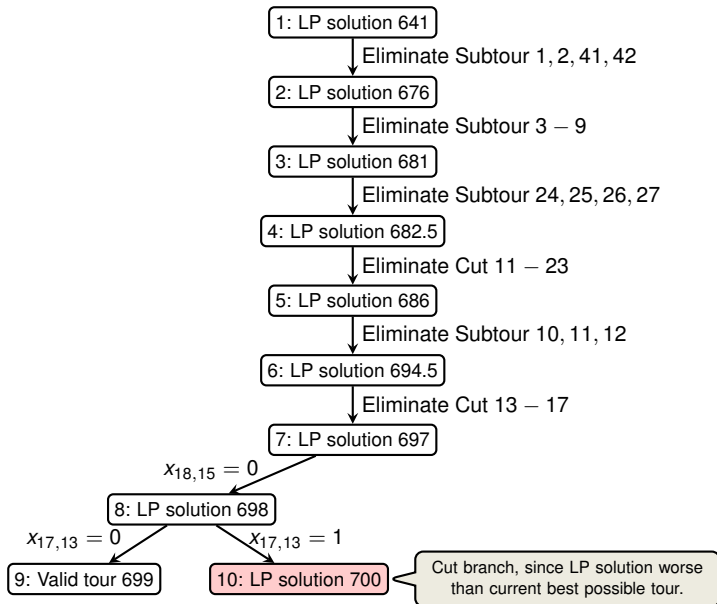

Branch & Bound Overview

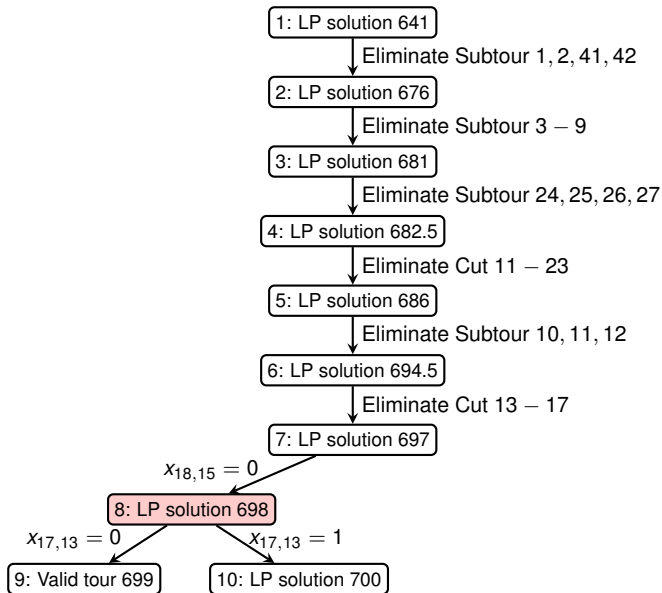

Branch & Bound Overview

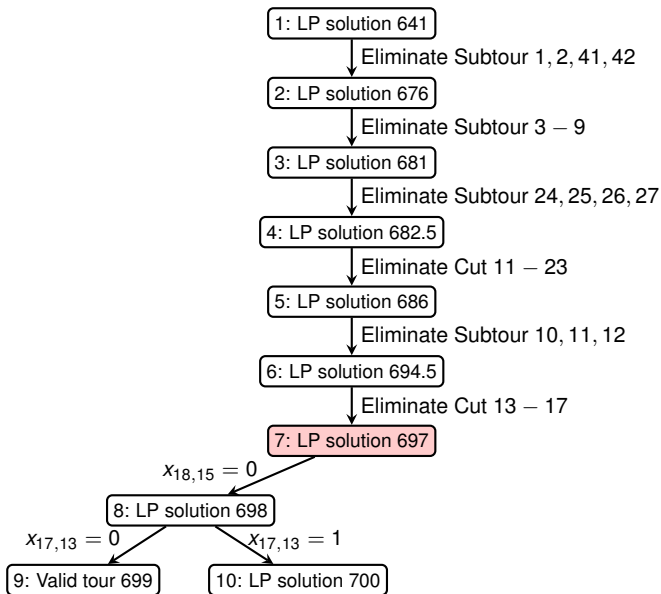

Branch & Bound Overview

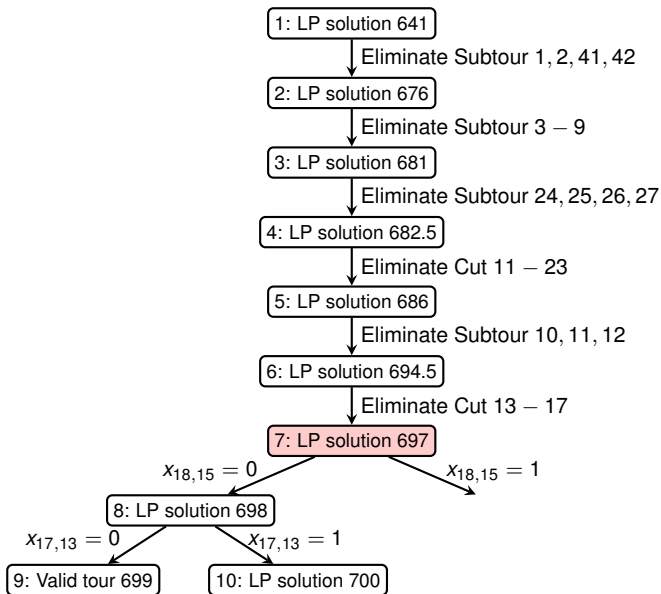

Branch & Bound Overview

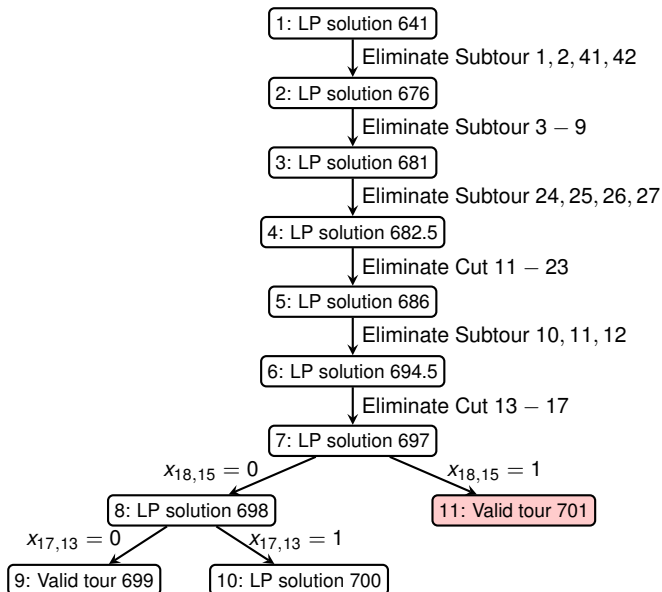

Branch & Bound Overview

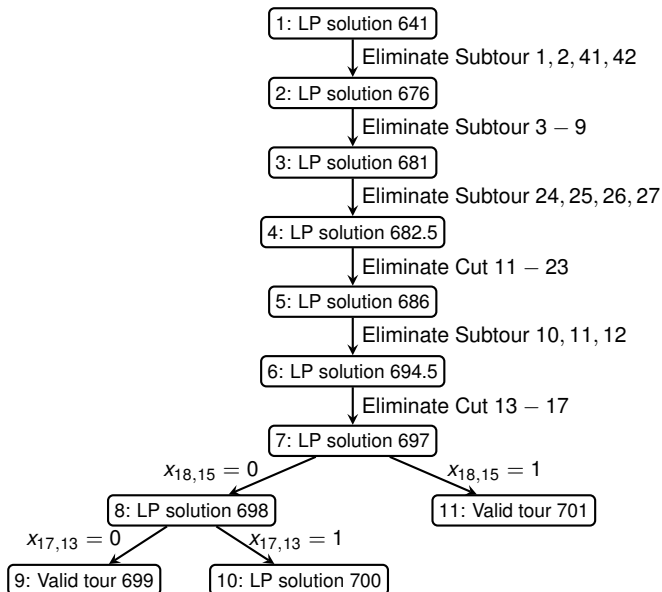

Iteration 7: Objective 697

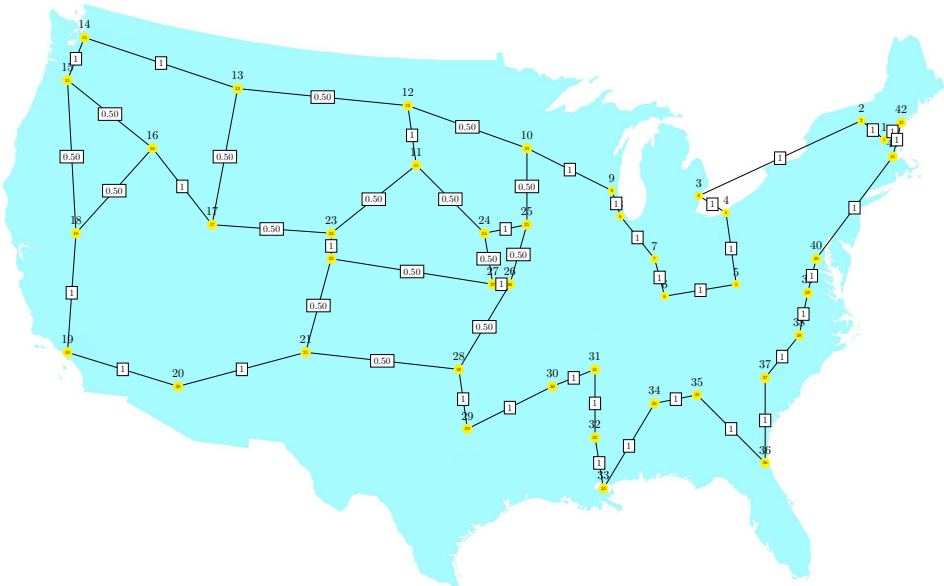

Iteration 7: Objective 697

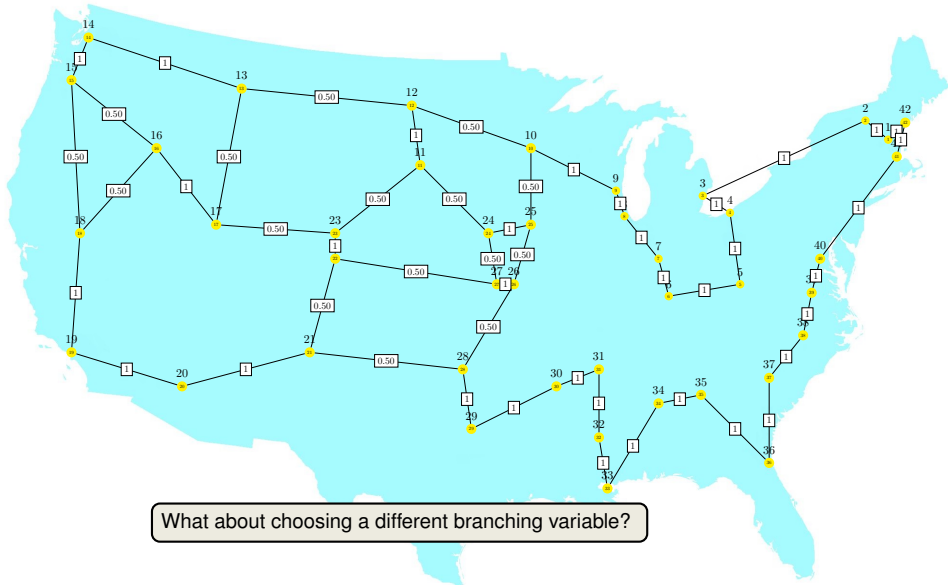

Solving Progress (Alternative Branch 1)

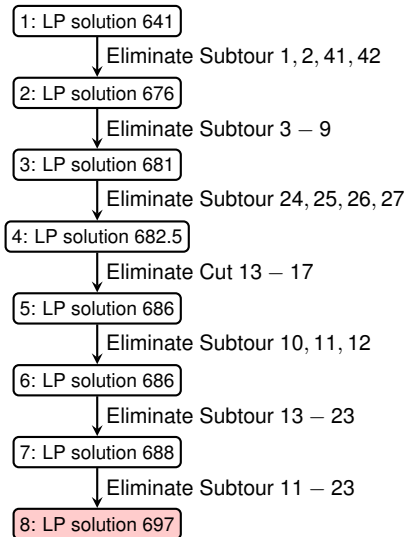

Solving Progress (Alternative Branch 1)

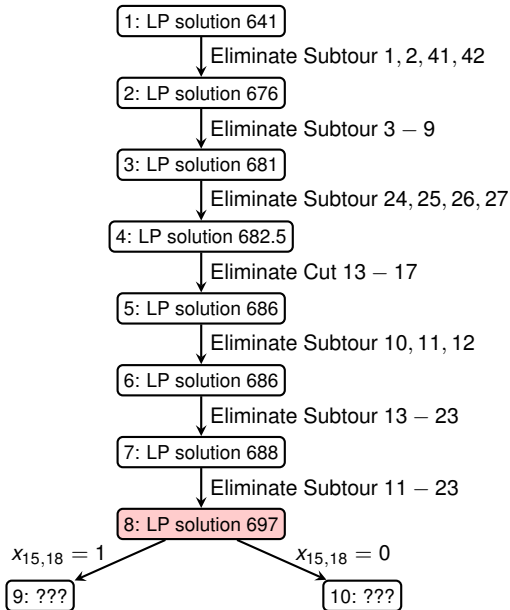

Alternative Branch 1: $X_{18,15}$, Objective 697

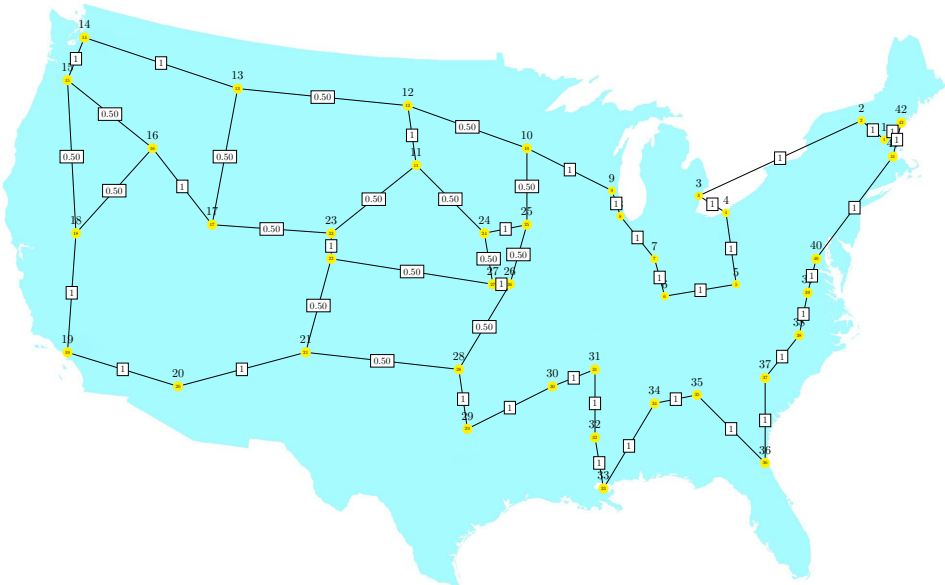

Alternative Branch 1: $X_{18,15}$, Objective 697

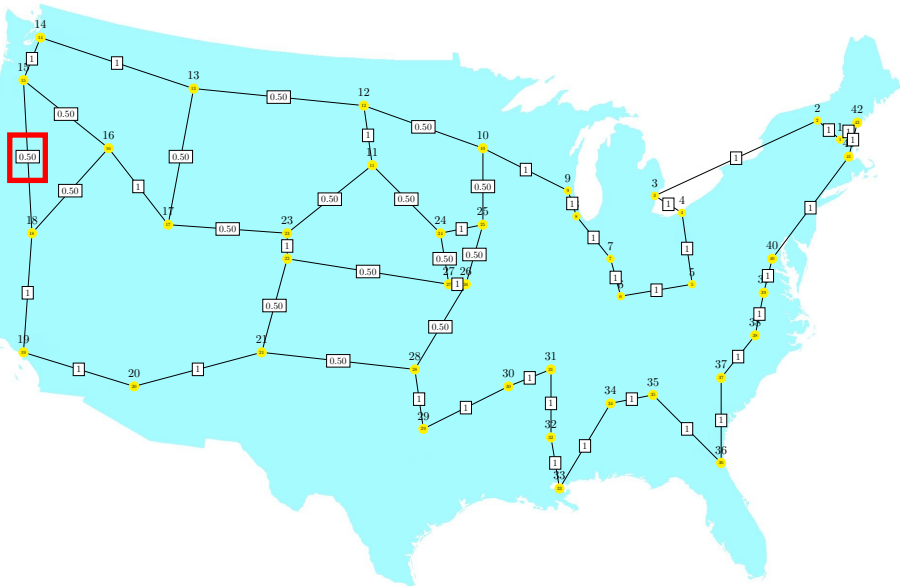

Alternative Branch 1a: $X_{18,15} = 1$, Objective 701 (Valid Tour)

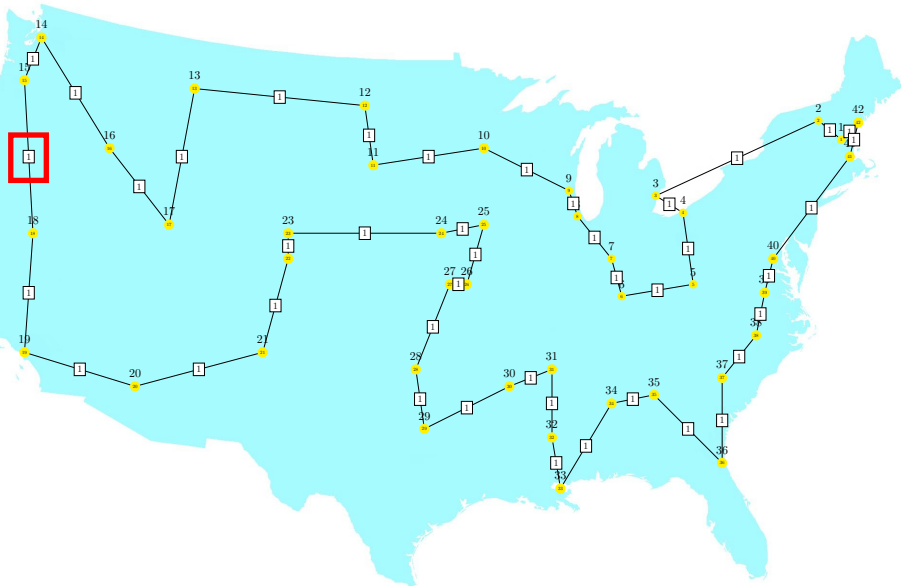

Alternative Branch 1b: $x_{18,15} = 0$, Objective 698

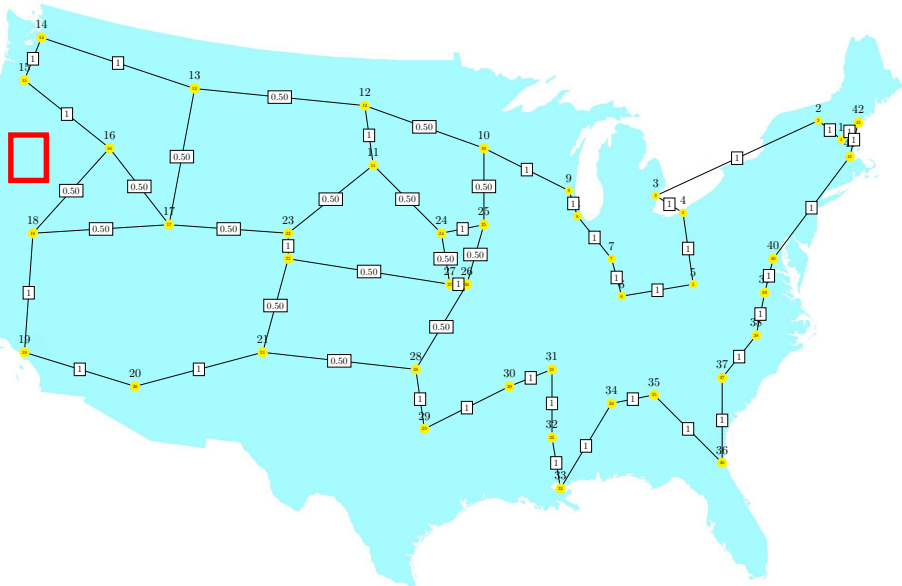

Solving Progress (Alternative Branch 1)

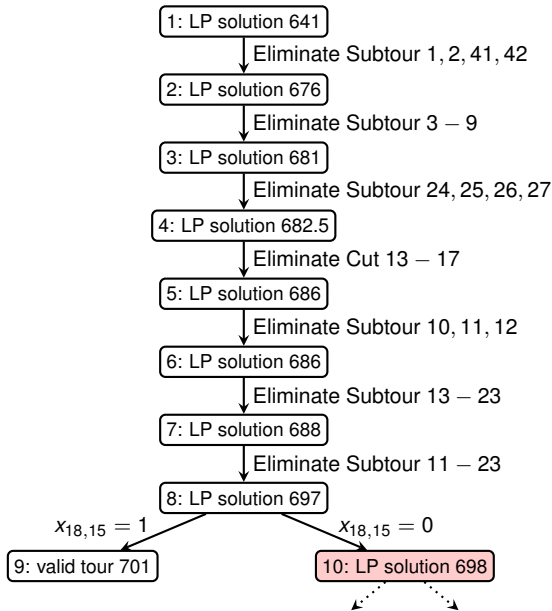

Solving Progress (Alternative Branch 2)

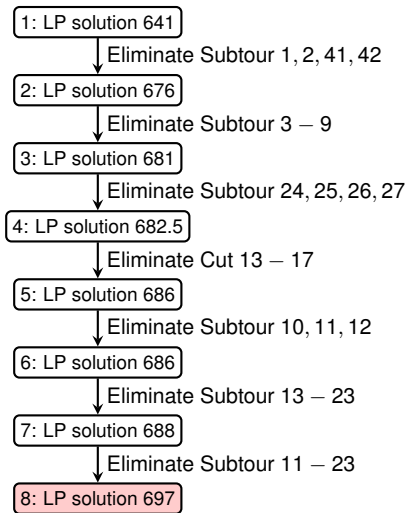

Solving Progress (Alternative Branch 2)

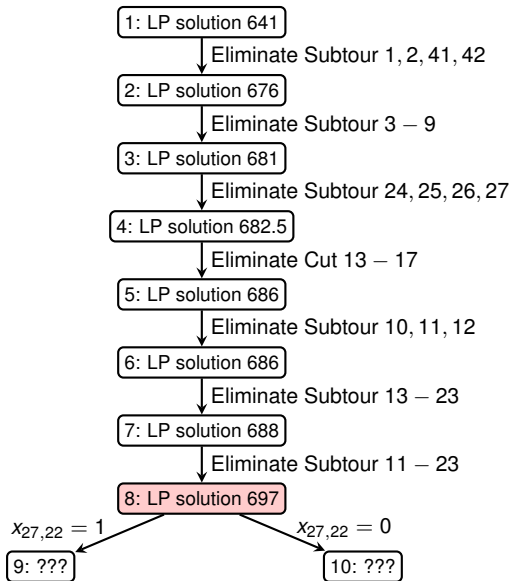

Alternative Branch 2: $X_{27,22}$, Objective 697

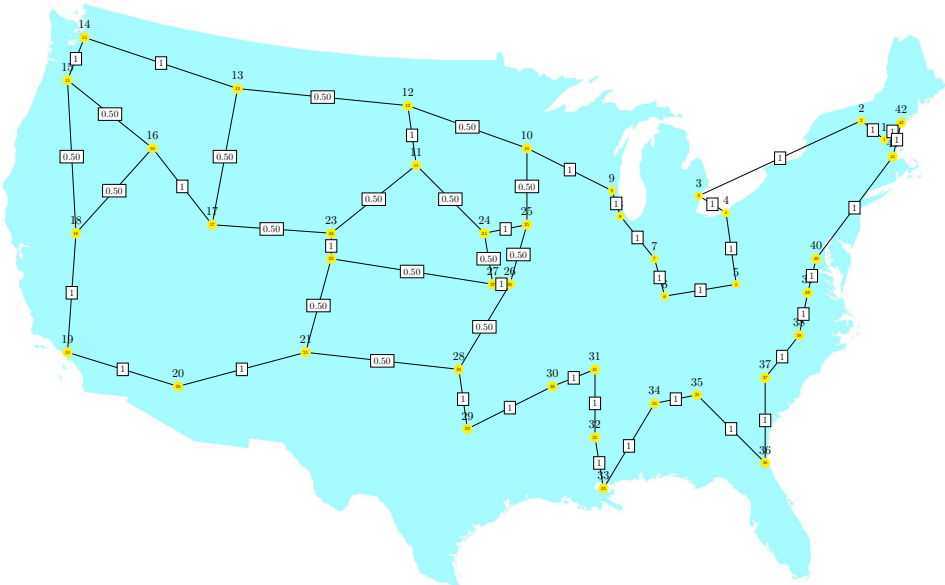

Alternative Branch 2: $X_{27,22}$, Objective 697

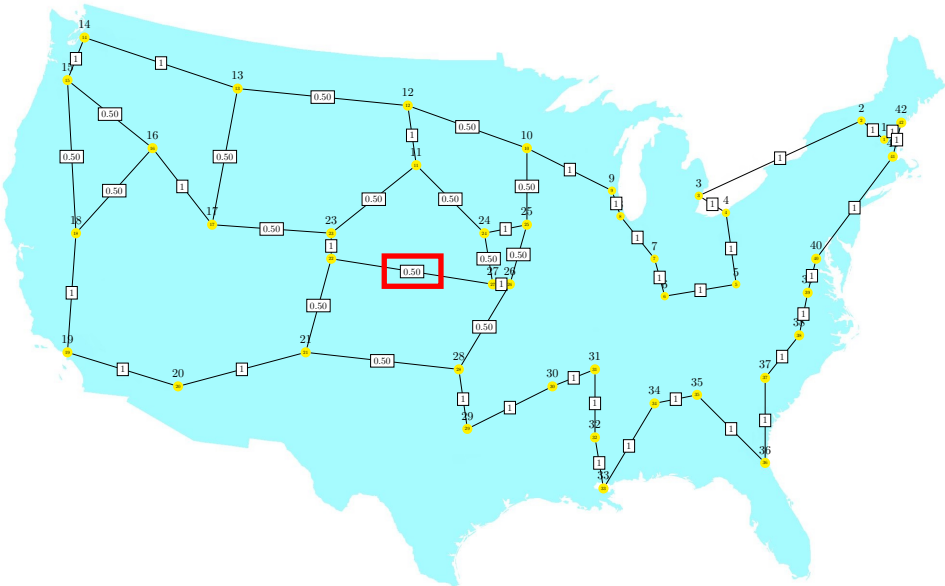

Alternative Branch 2a: $x_{27,22} = 1$, Objective 708 (Valid tour)

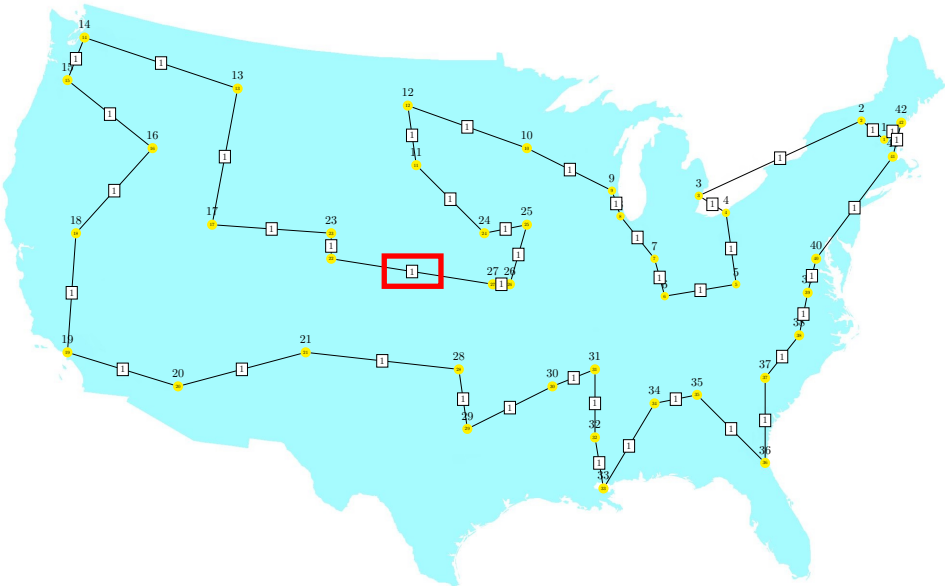

Alternative Branch 2b: $x_{27,22} = 0$, Objective 697.75

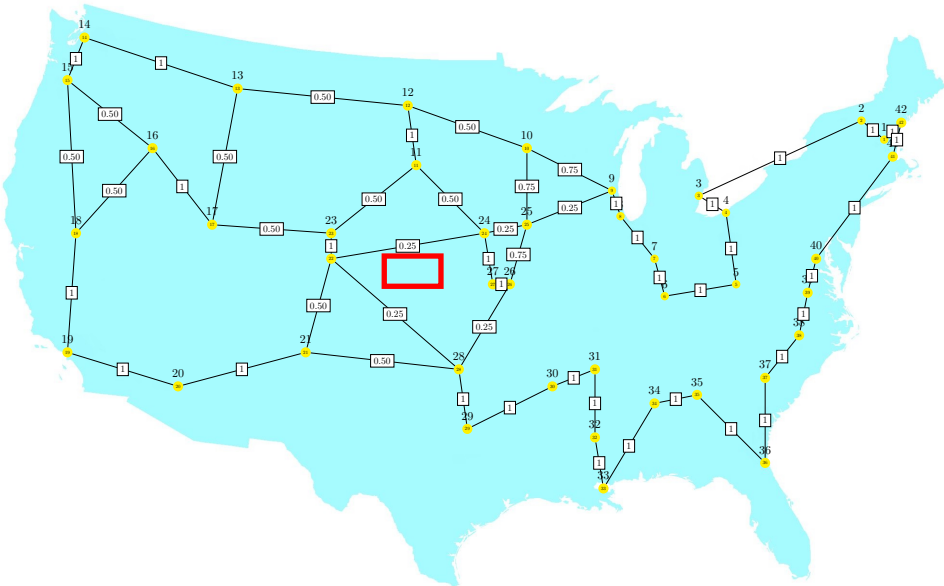

Solving Progress (Alternative Branch 2)

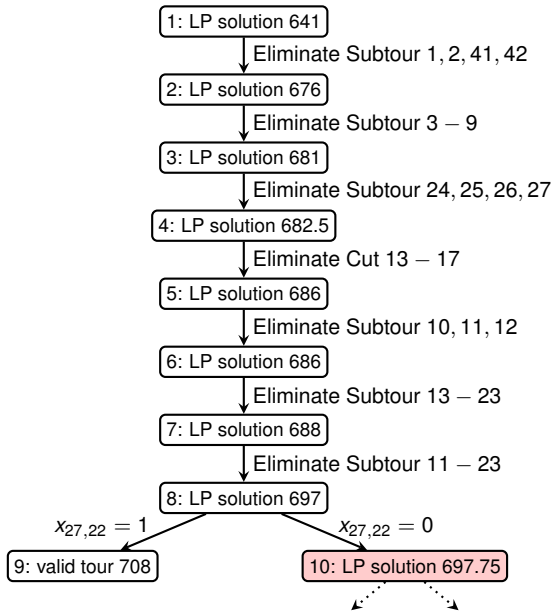

Solving Progress (Alternative Branch 3)

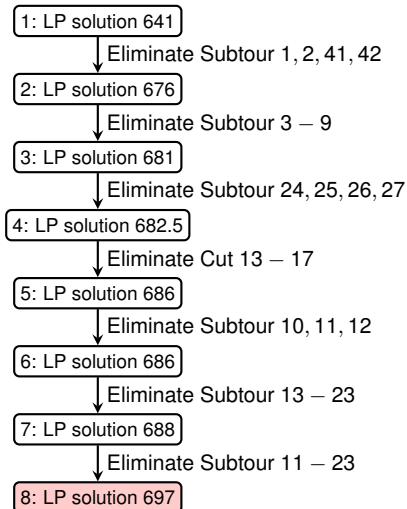

Solving Progress (Alternative Branch 3)

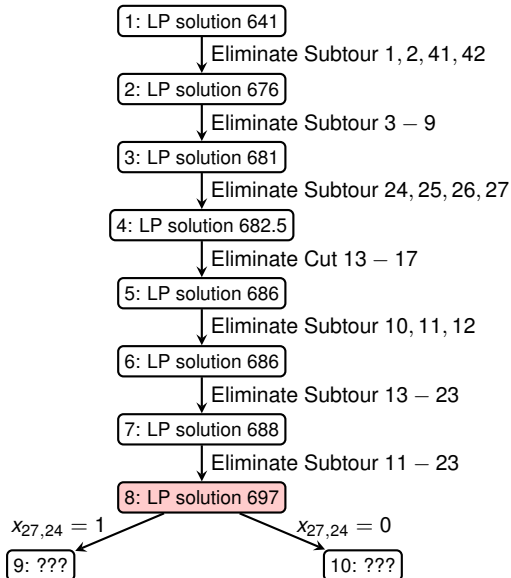

Alternative Branch 3: $X_{27,24}$, Objective 697

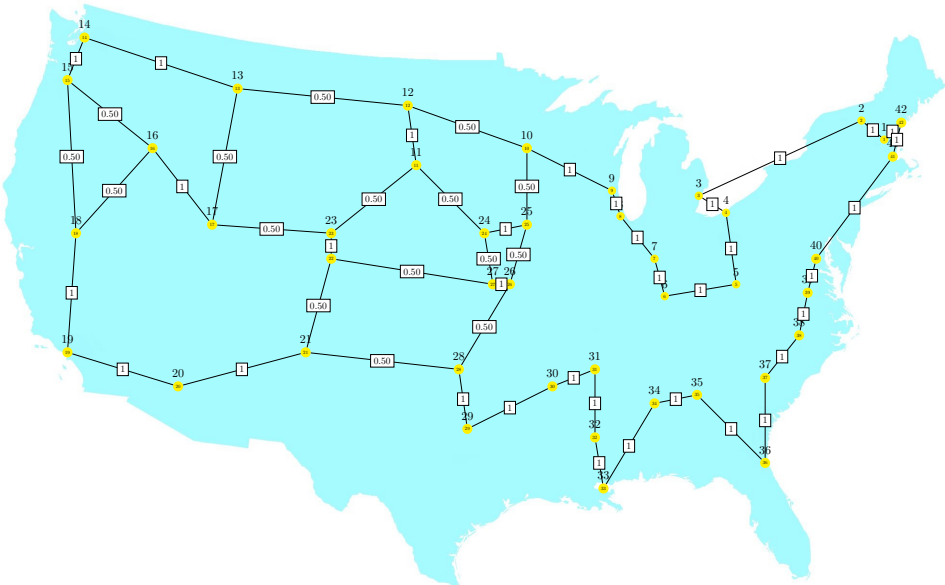

Alternative Branch 3: $X_{27,24}$, Objective 697

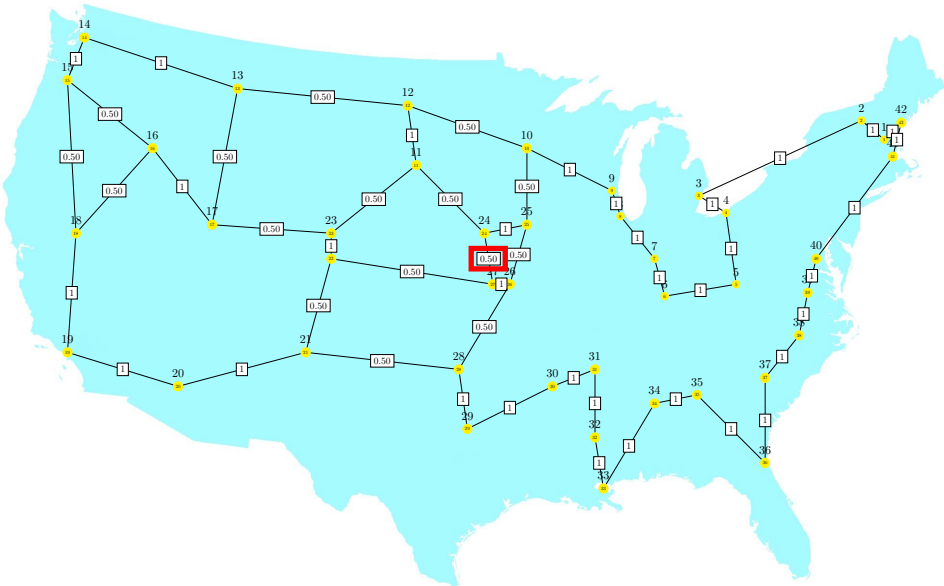

Alternative Branch 3a: $x_{27,24} = 1$, Objective 697.75

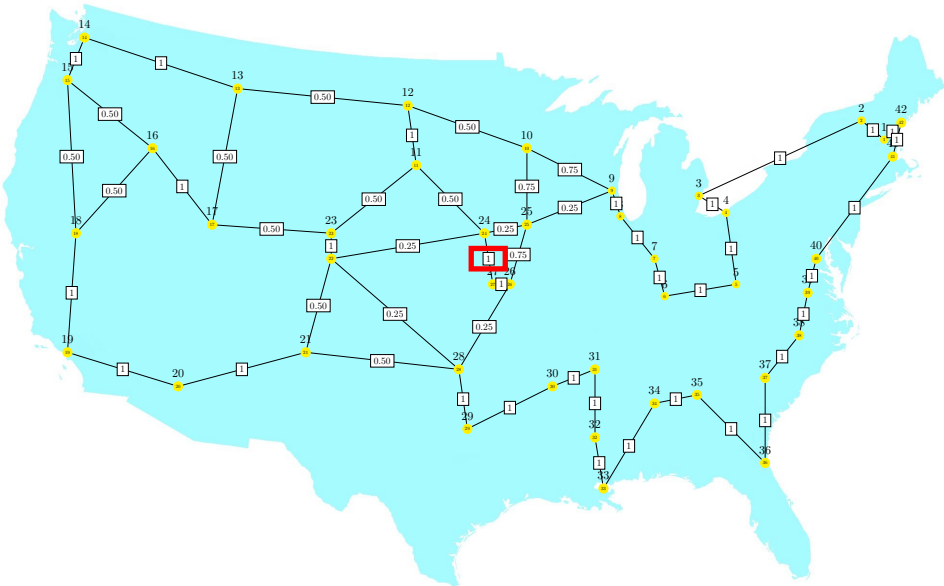

Alternative Branch 3b: $x_{27,24} = 0$, Objective 698

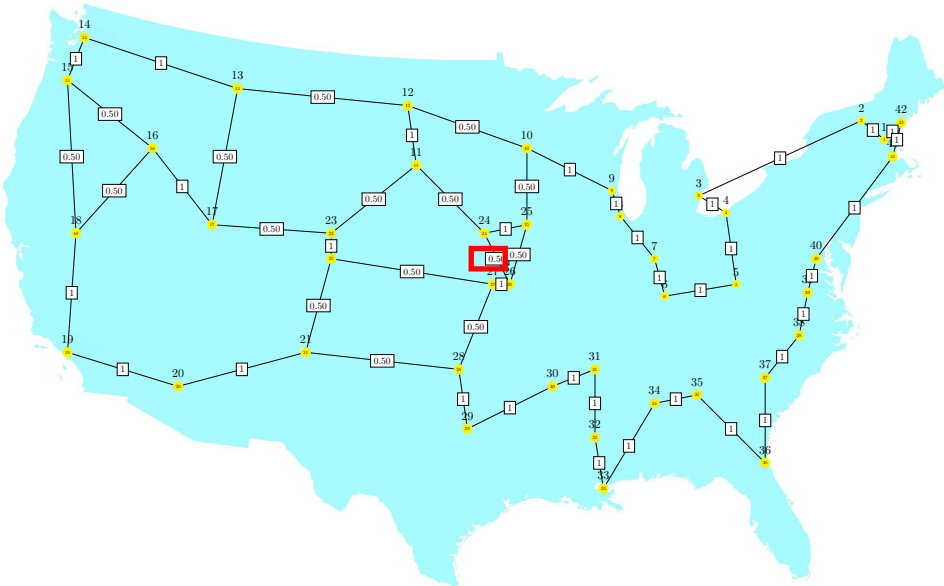

Solving Progress (Alternative Branch 3)

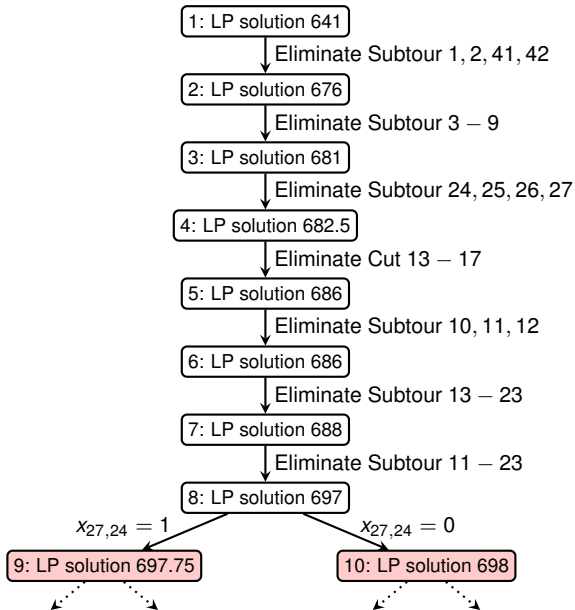

Solving Progress (Alternative Branch 3)

1: LP solution 641

Eliminate Subtour 1, 2, 41, 42

2: LP solution 676

Eliminate Subtour 3 – 9

3: LP solution 681

Eliminate Subtour 24, 25, 26, 27

4: LP solution 682.5

Not only do we have to explore (and branch further in) both subtrees, but also the optimal tour is in the subtree with larger LP solution!

6: LP solution 686

Eliminate Subtour 13 – 23

7: LP solution 688

Eliminate Subtour 11 – 23

8: LP solution 697

$x_{27,24} = 1$

9: LP solution 697.75

$x_{27,24} = 0$

10: LP solution 698

Conclusion (1/2)

- How can one generate these constraints automatically?

Conclusion (1/2)

- How can one generate these constraints automatically?
Subtour Elimination: Finding Connected Components
Small Cuts: Finding the Minimum Cut in Weighted Graphs

Conclusion (1/2)

- How can one generate these constraints automatically?
Subtour Elimination: Finding Connected Components
Small Cuts: Finding the Minimum Cut in Weighted Graphs
- Why don't we add all possible Subtour Elimination constraints to the LP?

Conclusion (1/2)

- How can one generate these constraints automatically?
Subtour Elimination: Finding Connected Components
Small Cuts: Finding the Minimum Cut in Weighted Graphs
- Why don't we add all possible Subtour Elimination constraints to the LP?
There are exponentially many of them!

Conclusion (1/2)

- How can one generate these constraints automatically?
Subtour Elimination: Finding Connected Components
Small Cuts: Finding the Minimum Cut in Weighted Graphs
- Why don't we add all possible Subtour Elimination constraints to the LP?
There are exponentially many of them!
- Should the search tree be explored by BFS or DFS?

Conclusion (1/2)

- How can one generate these constraints automatically?
Subtour Elimination: Finding Connected Components
Small Cuts: Finding the Minimum Cut in Weighted Graphs
- Why don't we add all possible Subtour Elimination constraints to the LP?
There are exponentially many of them!
- Should the search tree be explored by BFS or DFS?
BFS may be more attractive, even though it might need more memory.

Conclusion (1/2)

- **How can one generate these constraints automatically?**
Subtour Elimination: Finding Connected Components
Small Cuts: Finding the Minimum Cut in Weighted Graphs
- **Why don't we add all possible Subtour Elimination constraints to the LP?**
There are exponentially many of them!
- **Should the search tree be explored by BFS or DFS?**
BFS may be more attractive, even though it might need more memory.

CONCLUDING REMARK

It is clear that we have left unanswered practically any question one might pose of a theoretical nature concerning the traveling-salesman problem; however, we hope that the feasibility of attacking problems involving a moderate number of points has been successfully demonstrated, and that perhaps some of the ideas can be used in problems of similar nature.

Conclusion (2/2)

- Eliminate Subtour 1, 2, 41, 42
- Eliminate Subtour 3 – 9
- **Eliminate Subtour 10, 11, 12**
- Eliminate Subtour 11 – 23
- Eliminate Subtour 13 – 23
- Eliminate Cut 13 – 17
- Eliminate Subtour 24, 25, 26, 27

Conclusion (2/2)

- Eliminate Subtour 1, 2, 41, 42
- Eliminate Subtour 3 – 9
- Eliminate Subtour 10, 11, 12
- Eliminate Subtour 11 – 23
- Eliminate Subtour 13 – 23
- Eliminate Cut 13 – 17
- Eliminate Subtour 24, 25, 26, 27

THE 49-CITY PROBLEM*

The optimal tour \bar{x} is shown in Fig. 16. The proof that it is optimal is given in Fig. 17. To make the correspondence between the latter and its programming problem clear, we will write down in addition to 42 relations in non-negative variables (2), a set of 25 relations which suffice to prove that $D(x)$ is a minimum for \bar{x} . We distinguish the following subsets of the 42 cities:

$$S_1 = \{1, 2, 41, 42\}$$

$$S_2 = \{3, 4, \dots, 9\}$$

$$S_3 = \{1, 2, \dots, 9, 29, 30, \dots, 42\}$$

$$S_4 = \{11, 12, \dots, 23\}$$

$$S_5 = \{13, 14, \dots, 23\}$$

$$S_6 = \{13, 14, 15, 16, 17\}$$

$$S_7 = \{24, 25, 26, 27\}.$$

← → ↻ en.wikipedia.org/wiki/CPLEX
★

WIKIPEDIA
The Free Encyclopedia

- [Main page](#)
- [Contents](#)
- [Featured content](#)
- [Current events](#)
- [Random article](#)
- [Donate to Wikipedia](#)
- [Wikipedia store](#)

Interaction

- [Help](#)
- [About Wikipedia](#)
- [Community portal](#)
- [Recent changes](#)
- [Contact page](#)

Tools

- [What links here](#)
- [Related changes](#)
- [Upload file](#)
- [Special pages](#)

CPLEX

From Wikipedia, the free encyclopedia

IBM ILOG CPLEX Optimization Studio (often informally referred to simply as CPLEX) is an [optimization](#) software package. In 2004, the work on CPLEX earned the first INFORMS Impact Prize.

The CPLEX Optimizer was named for the [simplex method](#) as implemented in the [C programming language](#), although today it also supports other types of [mathematical optimization](#) and offers interfaces other than just C. It was originally developed by Robert E. Bixby and was offered commercially starting in 1988 by CPLEX Optimization Inc., which was acquired by [ILOG](#) in 1997; ILOG was subsequently acquired by IBM in January 2009.^[1] CPLEX continues to be actively developed under IBM.

The IBM ILOG CPLEX Optimizer solves [integer programming](#) problems, very large^[2] [linear programming](#) problems using either primal or dual variants of the [simplex method](#) or the barrier interior

CPLEX	
Developer(s)	IBM
Stable release	12.6
Development status	Active
Type	Technical computing
License	Proprietary
Website	ibm.com/software/products/ibmilogcpleoptstud/

Welcome to IBM(R) ILOG(R) CPLEX(R) Interactive Optimizer 12.6.1.0
with Simplex, Mixed Integer & Barrier Optimizers
5725-A06 5725-A29 5724-Y48 5724-Y49 5724-Y54 5724-Y55 5655-Y21
Copyright IBM Corp. 1988, 2014. All Rights Reserved.

Type 'help' for a list of available commands.
Type 'help' followed by a command name for more
information on commands.

```
CPLEX> read tsp.lp
Problem 'tsp.lp' read.
Read time = 0.00 sec. (0.06 ticks)
CPLEX> primopt
Tried aggregator 1 time.
LP Presolve eliminated 1 rows and 1 columns.
Reduced LP has 49 rows, 860 columns, and 2483 nonzeros.
Presolve time = 0.00 sec. (0.36 ticks)
```

```
Iteration log . . .
Iteration:    1   Infeasibility =          33.999999
Iteration:   26   Objective      =         1510.000000
Iteration:   90   Objective      =          923.000000
Iteration:  155   Objective      =          711.000000
```

```
Primal simplex - Optimal: Objective = 6.9900000000e+02
Solution time =    0.00 sec. Iterations = 168 (25)
Deterministic time = 1.16 ticks (288.86 ticks/sec)
```

```
CPLEX> █
```

```
CPLEX> display solution variables -
Variable Name      Solution Value
x_2_1              1.000000
x_42_1             1.000000
x_3_2              1.000000
x_4_3              1.000000
x_5_4              1.000000
x_6_5              1.000000
x_7_6              1.000000
x_8_7              1.000000
x_9_8              1.000000
x_10_9             1.000000
x_11_10            1.000000
x_12_11            1.000000
x_13_12            1.000000
x_14_13            1.000000
x_15_14            1.000000
x_16_15            1.000000
x_17_16            1.000000
x_18_17            1.000000
x_19_18            1.000000
x_20_19            1.000000
x_21_20            1.000000
x_22_21            1.000000
x_23_22            1.000000
x_24_23            1.000000
x_25_24            1.000000
x_26_25            1.000000
x_27_26            1.000000
x_28_27            1.000000
x_29_28            1.000000
x_30_29            1.000000
x_31_30            1.000000
x_32_31            1.000000
x_33_32            1.000000
x_34_33            1.000000
x_35_34            1.000000
x_36_35            1.000000
x_37_36            1.000000
x_38_37            1.000000
x_39_38            1.000000
x_40_39            1.000000
x_41_40            1.000000
x_42_41            1.000000
```

All other variables in the range 1-861 are 0.