



UNIVERSITY OF  
CAMBRIDGE

# Integrating Scale Out and Fault Tolerance in Stream Processing using Operator State Management

with Raul Castro Fernandez\*

Matteo Migliavacca<sup>+</sup> and Peter Pietzuch\*

\*Imperial College London, <sup>+</sup>Kent Univerisity

# Big data ...

## ... in numbers:

- 2.5 billions on gigabytes of data every day (source IBM)
- LSST telescope, Chile 2016, 30 TB nightly

## ... come from everywhere:

- web feeds, social networking
- mobile devices, sensors, cameras
- scientific instruments
- online transactions (public and private sectors)



## ... have value:

- Global Pulse forum for detecting human crises internationally
- real-time big data analytics in UK £25 billions → £216 billions in 2012-17
- recommendation applications (LinkedIn, Amazon)

👉 processing infrastructure for big data analysis

# A black-box approach for big data analysis

- users issue analysis **queries** with real-time semantics
- **streams** of data updates, **time-varying rates**, generated in **real-time**
- **streams of result data**
- ✓ processing in **near real-time**

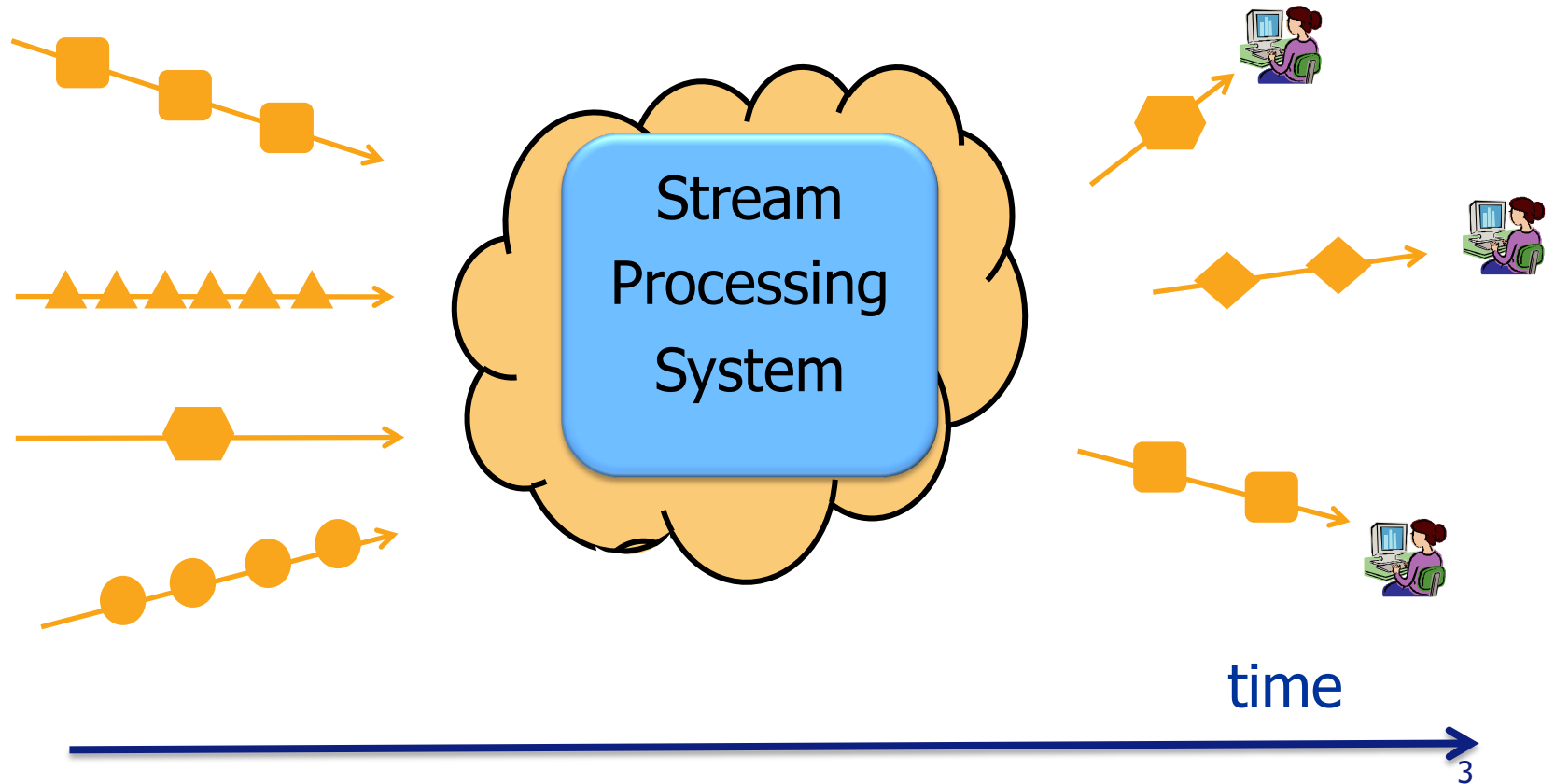

# Distributed Stream Processing System

- queries consist of **operators** (join, map, select, ..., UDOs)
- operators form graphs
- operators process **streams of tuples** on-the-fly
- operators span nodes

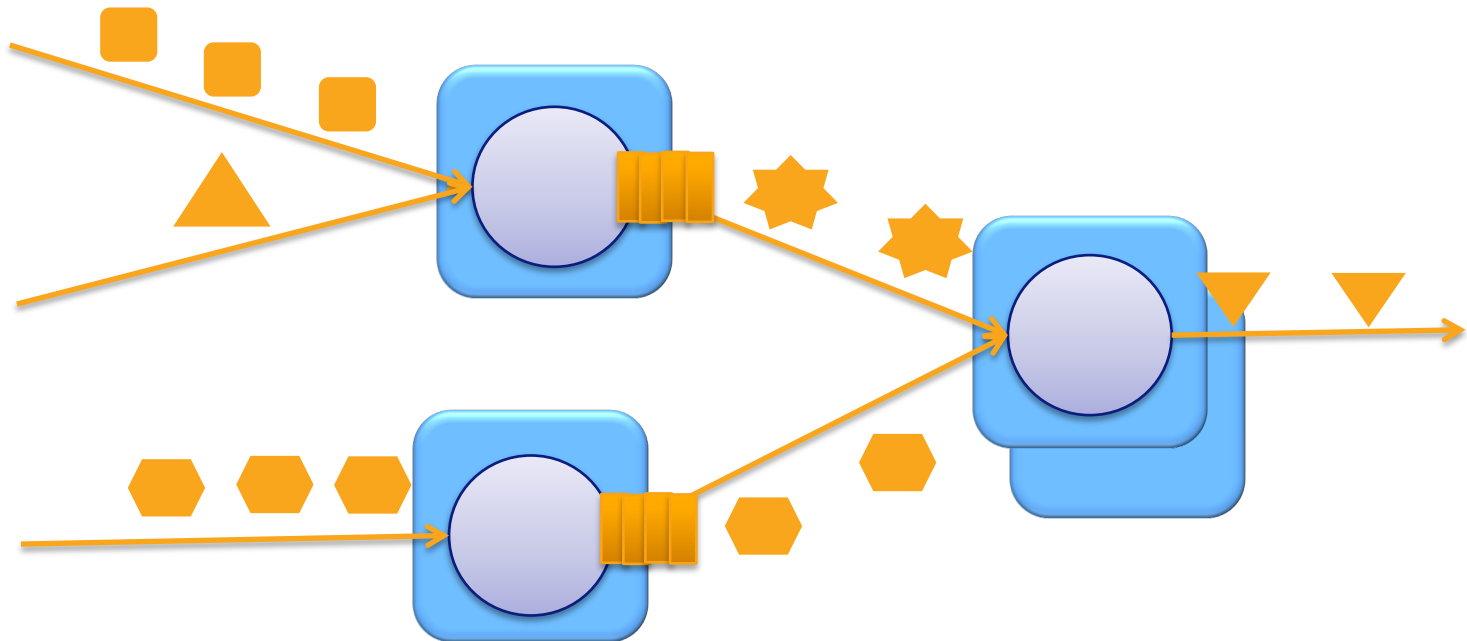

# Elastic DSPSs in the Cloud

## Real-time big data analysis challenge traditional DSPS:

- ? what about continuous workload surges?
- ? what about real-time resource allocation to workload variations?
- ? keeping the state correct for *stateful* operators?

## Massively scalable , cloud-based DSPSs [SIGMOD 2013]

1. gracefully handles **stateful** operators' state
2. operator **state management** for **combined** scale out and fault tolerance
3. SEEP system and evaluation
4. related work
5. future research directions

# Stream Processing in the Cloud

clouds provide infinite pools of resources

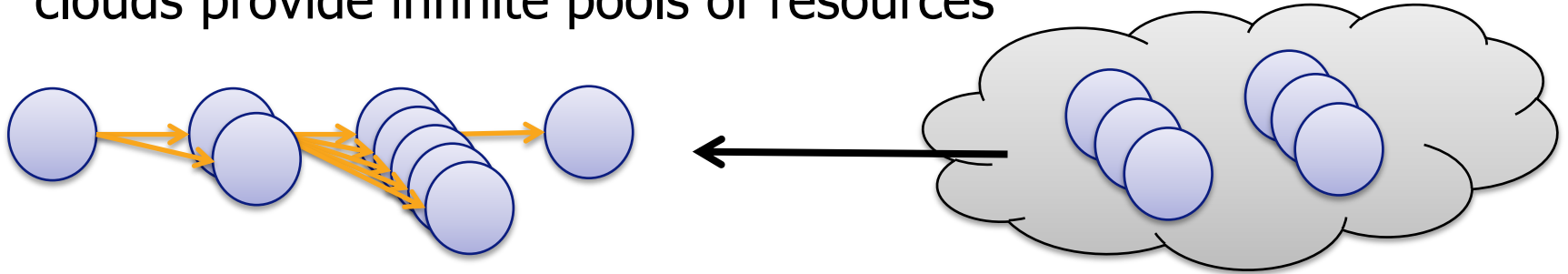

? How do we build a stream processing platform in the Cloud?

## Intra-query parallelism:

- provisioning for workload peaks unnecessarily conservative

### ☛ **dynamic scale out:**

increase resources when peaks appear

## Failure resilience:

- active fault-tolerance needs 2x resources
- passive fault-tolerance leads to long recovery times

### ☛ **hybrid fault-tolerance:**

low resource overhead with fast recovery

☛ Both mechanisms must support **stateful** operators

# Stateless vs Stateful Operators

**operator state:** a summary of past tuples' processing

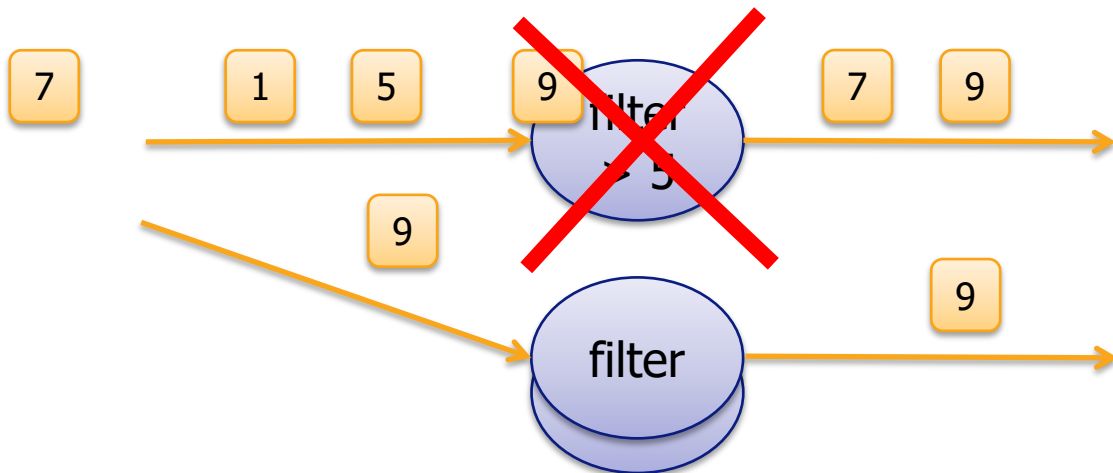

**stateless:**

- ✓ failure recovery
- ✓ scale out

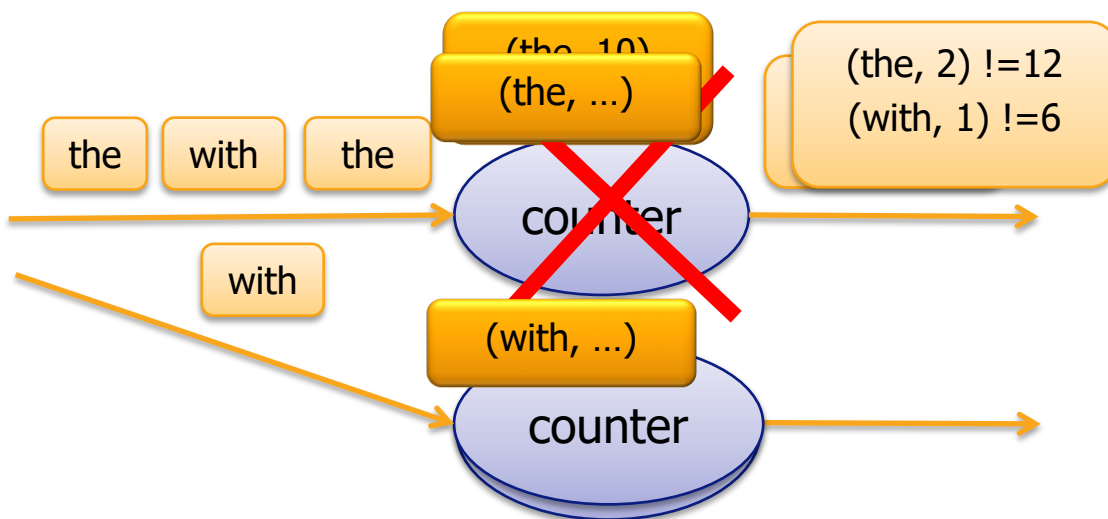

**stateful:**

- × failure recovery
- × scale out

# State Management

 **processing state:** (summary of past tuples' processing)

 **routing state:** (routing of tuples)

 **buffer state:** (tuples)

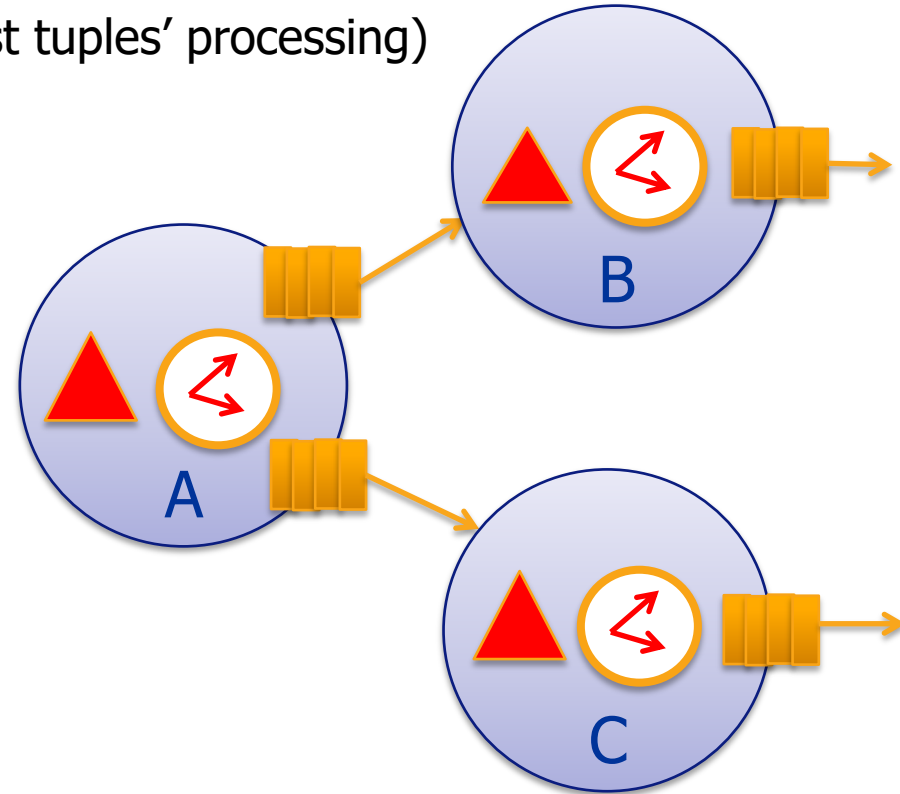

- operator state is an external entity managed by the DSPS
- **primitives** for state management
- **mechanisms** (scale out, failure recovery) on top of primitives
- **dynamic reconfiguration** of the dataflow graph



# State Management Primitives

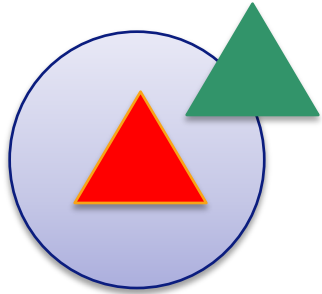

☛ **checkpoint**

takes snapshot of state and makes it externally available

moves copy of state from one operator to another

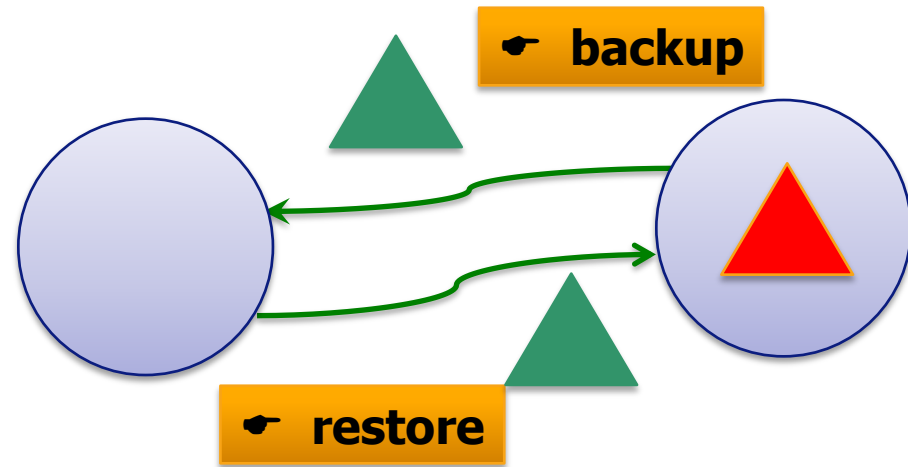

☛ **backup**

☛ **restore**

splits state in a semantically correct fashion for parallel processing

☛ **partition**

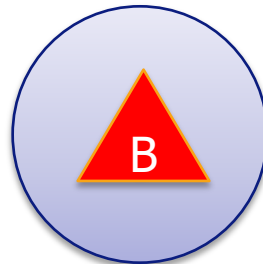
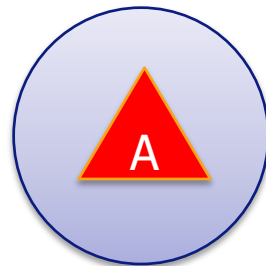
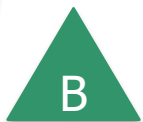
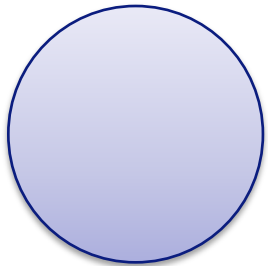

# State Management Scale Out, Stateful Ops

backup node already has state of operator to be parallelised

periodically, stateful operators checkpoint and back up state to designated **upstream backup node**, in memory

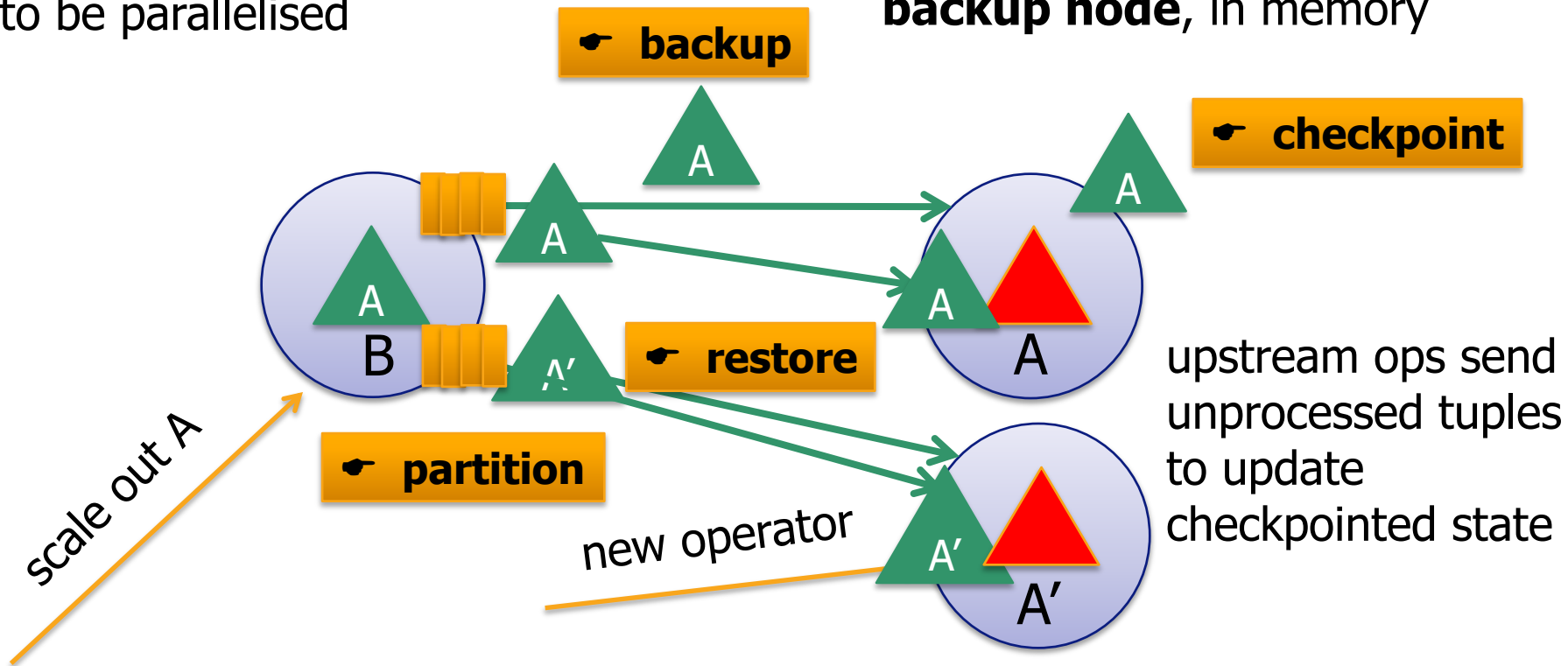

How do we partition **stateful** operators?

# Partitioning Stateful Operators

1. Processing state modeled as (key, value) dictionary
2. State partitioned according to key k of tuples
3. Tuples will be routed to correct operator as of k

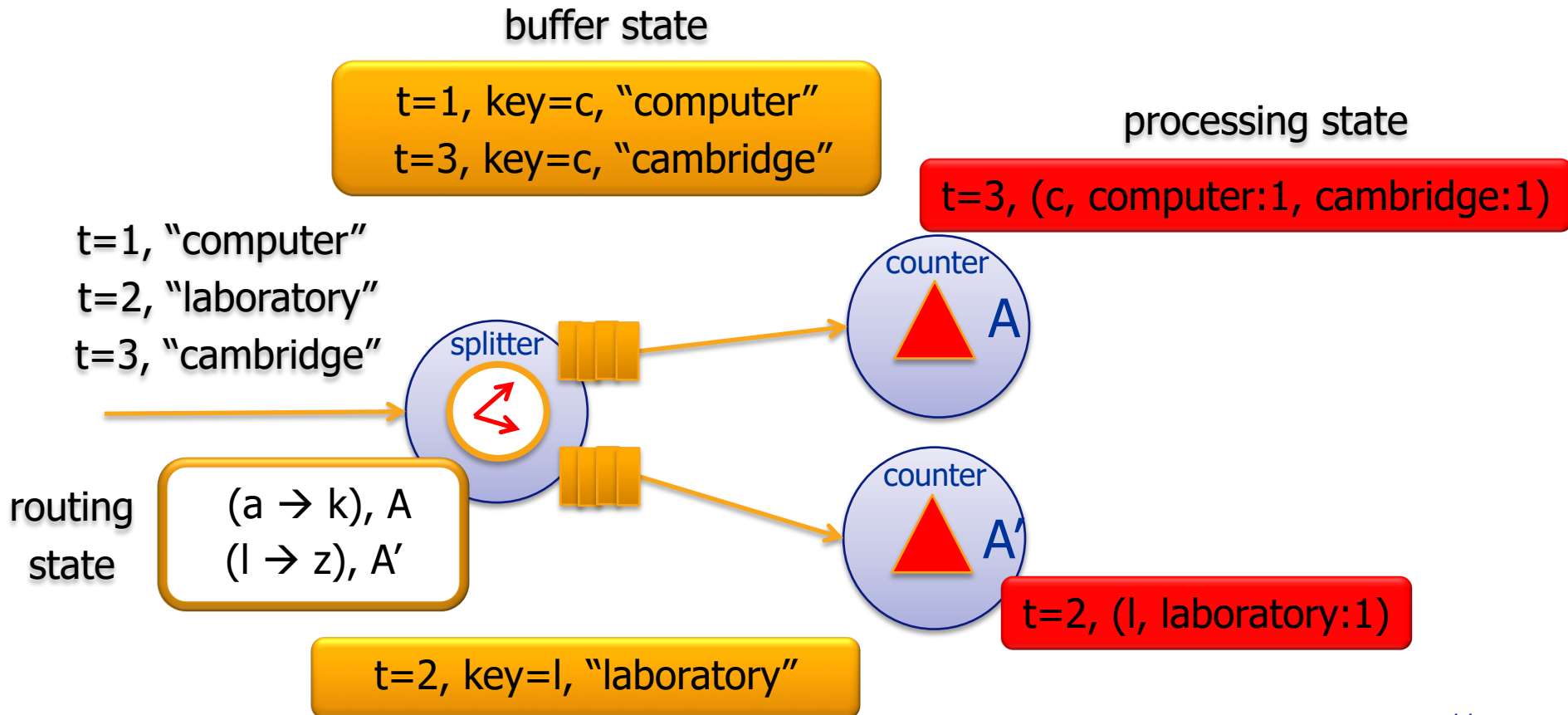

# Passive Fault-Tolerance Model

recreate operator state by replaying tuples after failure:

- **upstream backup**: sends acks upstream for tuples processed downstream

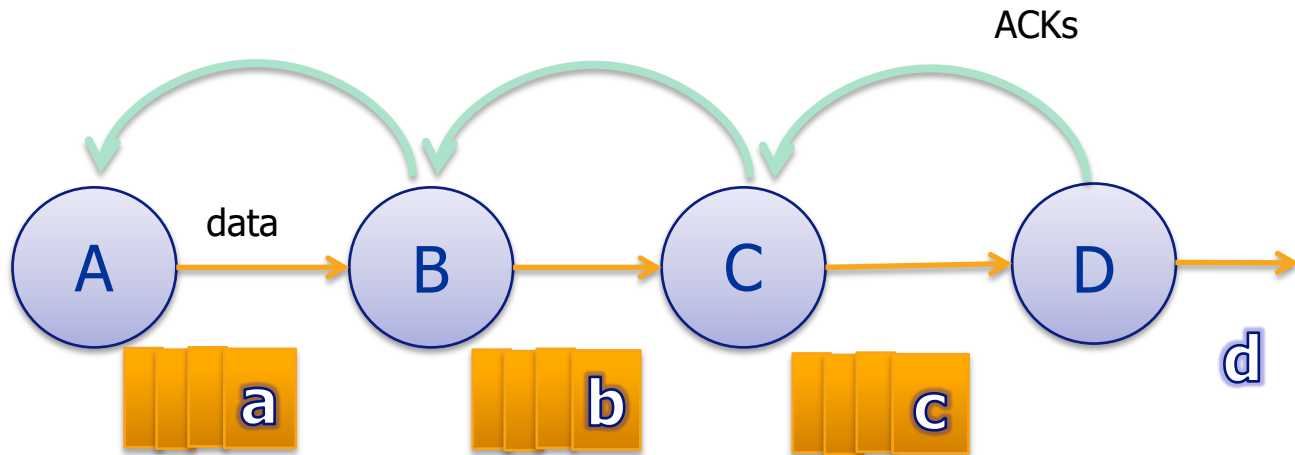

may result in long recovery times due to large buffers:

- system is reprocessing streams after failure → inefficient

# Recovering using State Management (R+SM)

## Benefit from state management primitives:

- use periodically backed up state on upstream node to recover faster
- trim buffers at backup node
- same primitives as in scale out

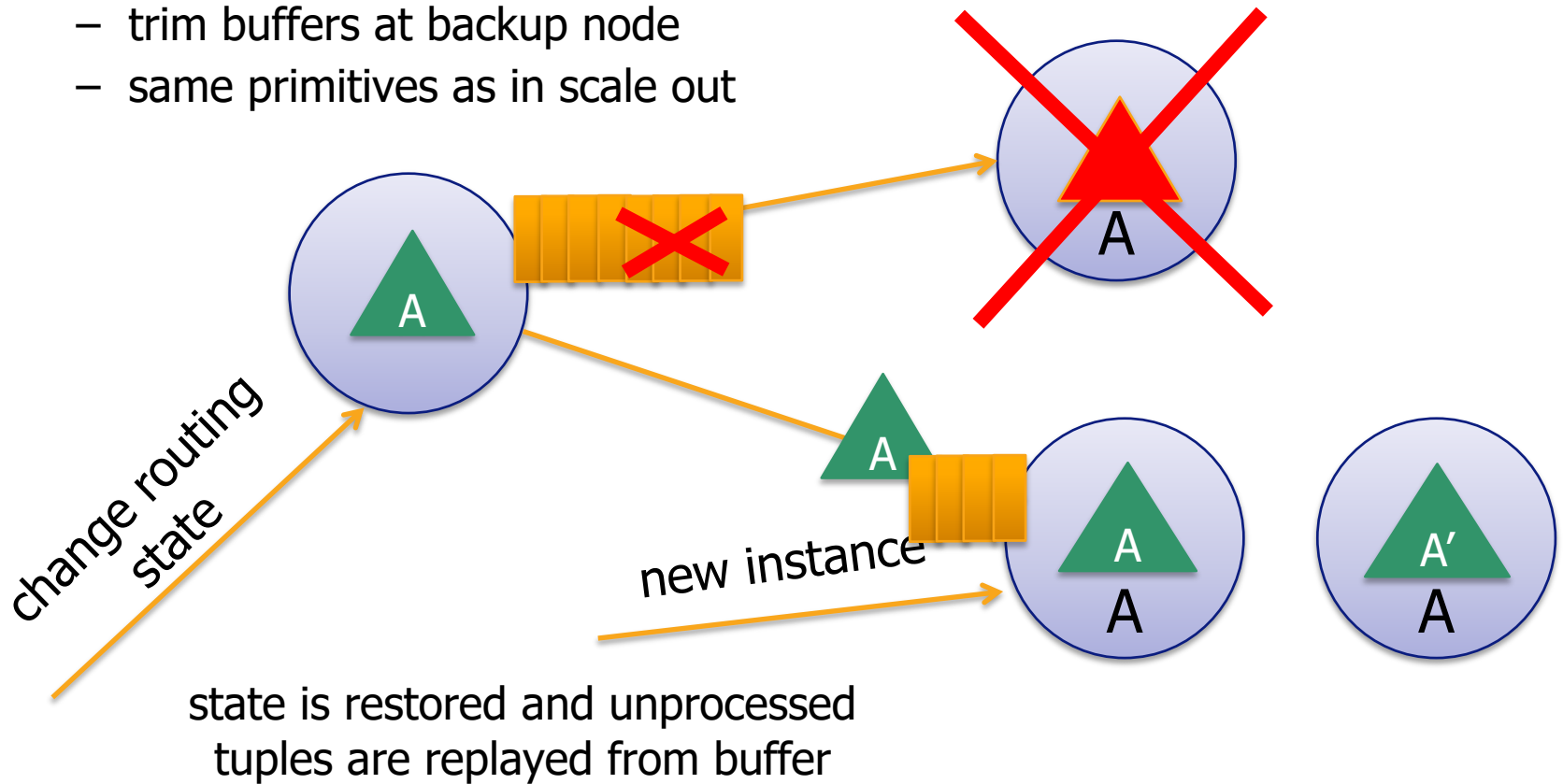

☛ same primitives for parallel recovery

# State Management in Action: SEEP

**(1) dynamic Scale Out:** detect bottleneck , add new parallelised operator

**(2) failure Recovery:** detect failure, replace with new operator

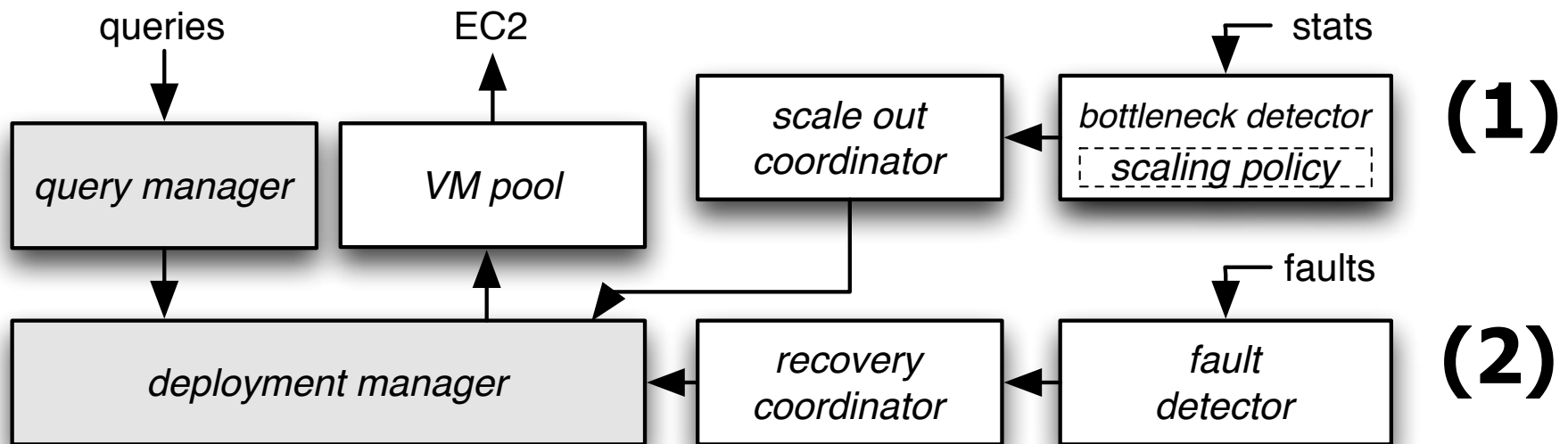

# Dynamic Scale Out: Detecting bottlenecks

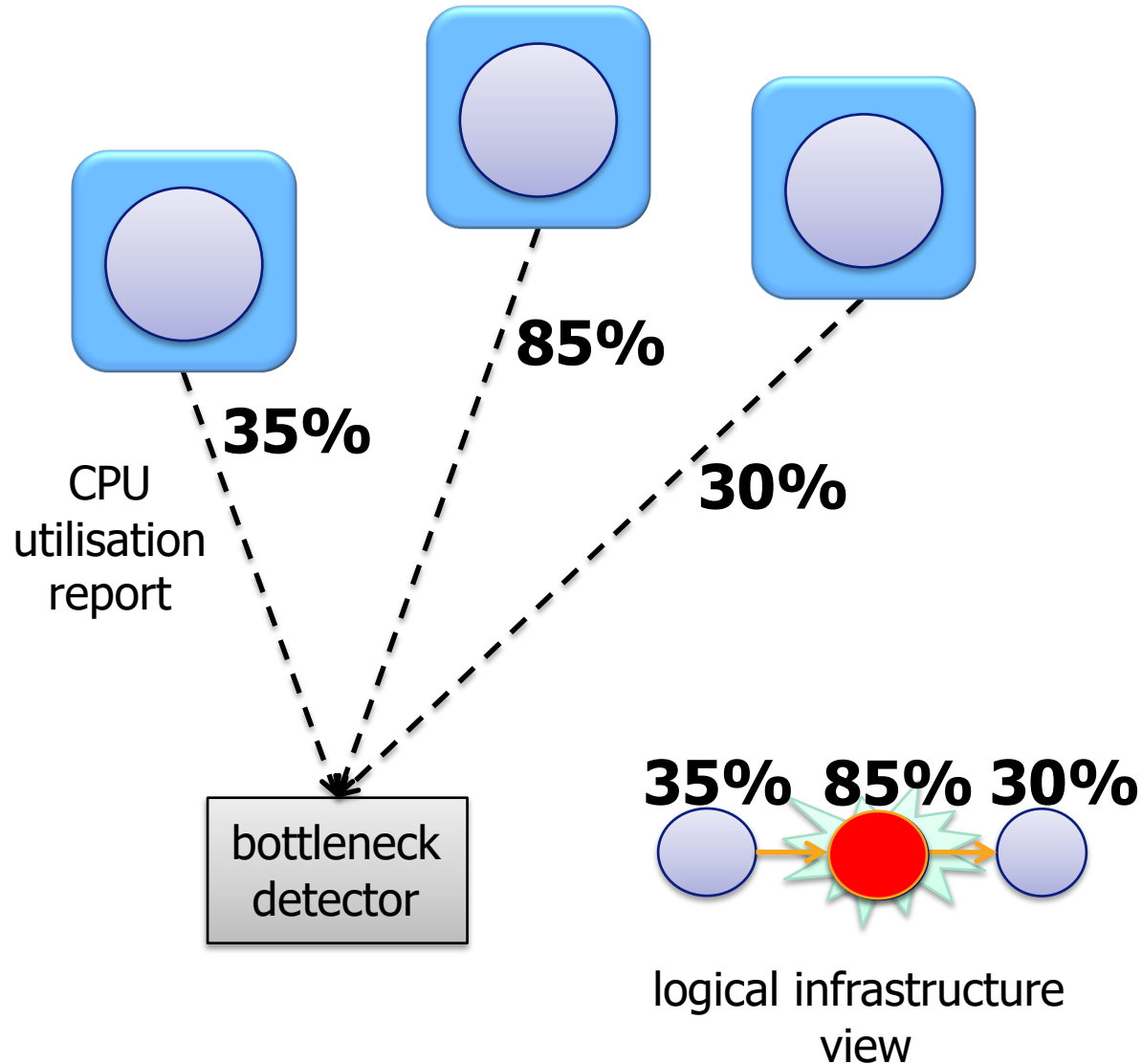

# The VM Pool: Adding operators

**problem:** allocating new VMs takes minutes...

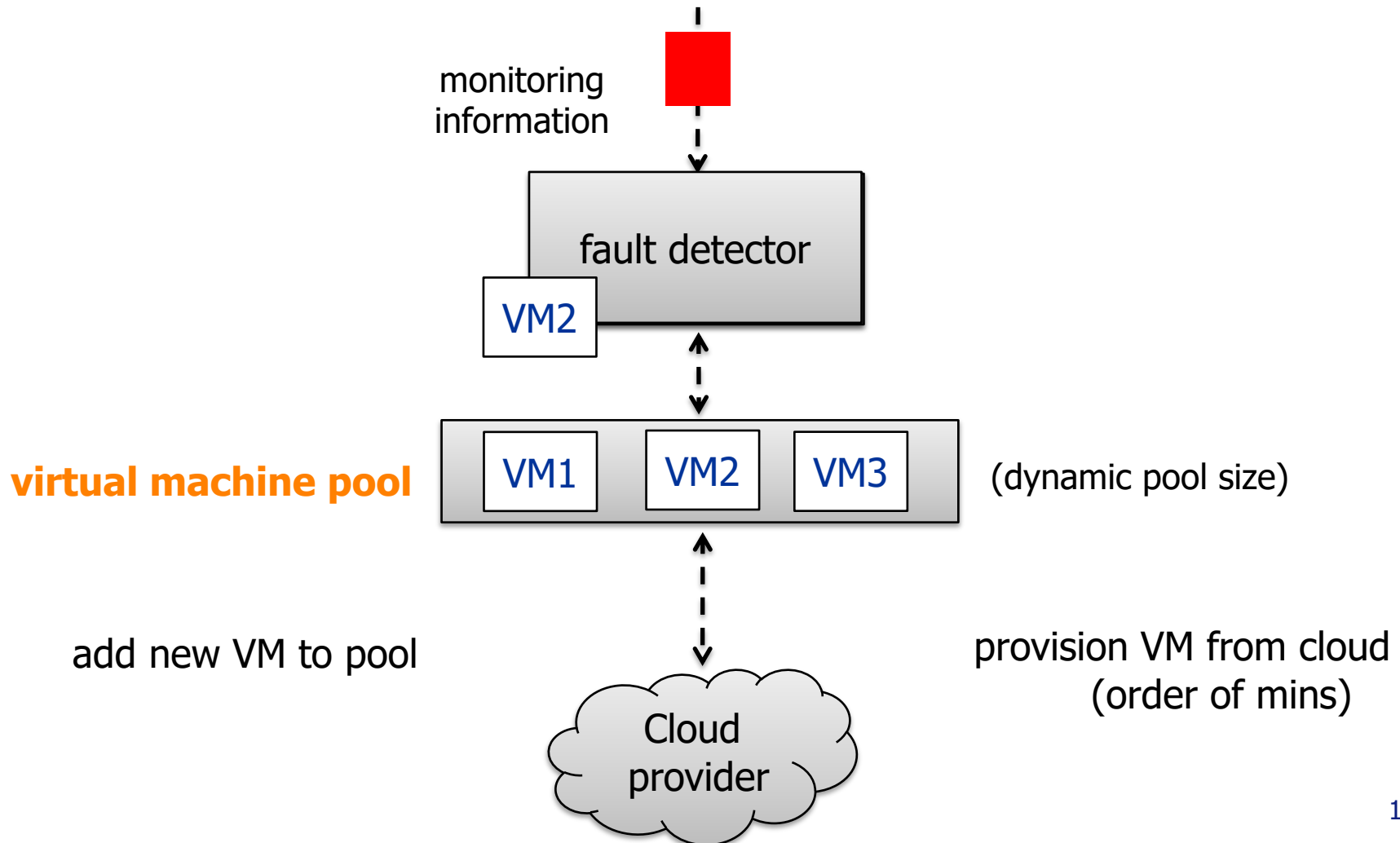



# Experimental Evaluation

## Goals:

- investigate effectiveness of **scale out** mechanism
- recovery time after failure using **R+SM**
- overhead of **state management**

## Scalable and Elastic Event Processing (SEEP):

- implemented in Java; Storm-like data flow model

## Sample queries + workload

- **Linear Road Benchmark** (LRB) to evaluate scale out [VLDB'04]
  - provides an increasing stream workload over time
  - query with 8 operators, 3 are stateful; SLA: results < 5 secs
- **Windowed word count query** (2 ops) to evaluate fault tolerance
  - induce failure to observe performance impact

## Deployment on Amazon AWS EC2

- sources and sinks on high-memory double extra large instances
- operators on small instances

# Scale Out: LRB Workload

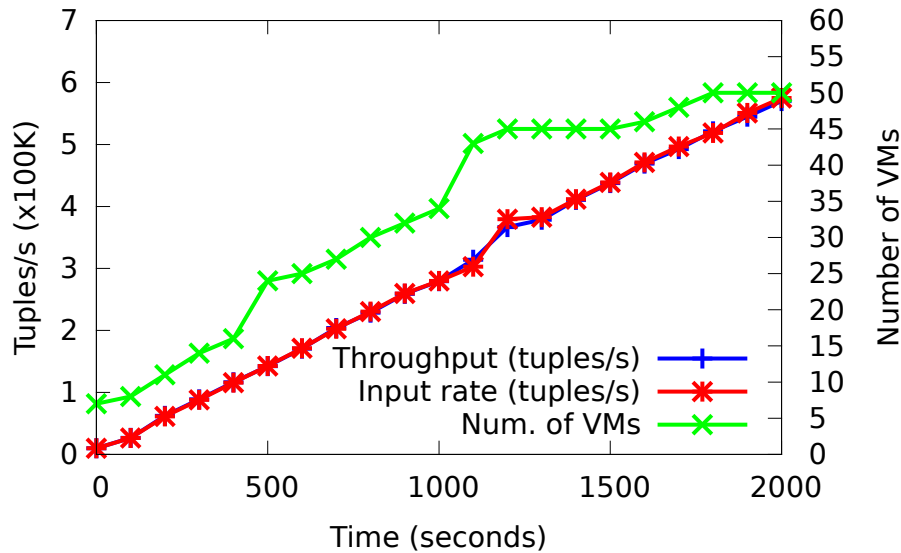

**scales to load factor L=350  
with 50 VMs on Amazon EC2**  
(automated query parallelisation,  
scale out policy at 70%)

**L=512 highest result** [VLDB'12]  
(hand-crafted query on cluster)

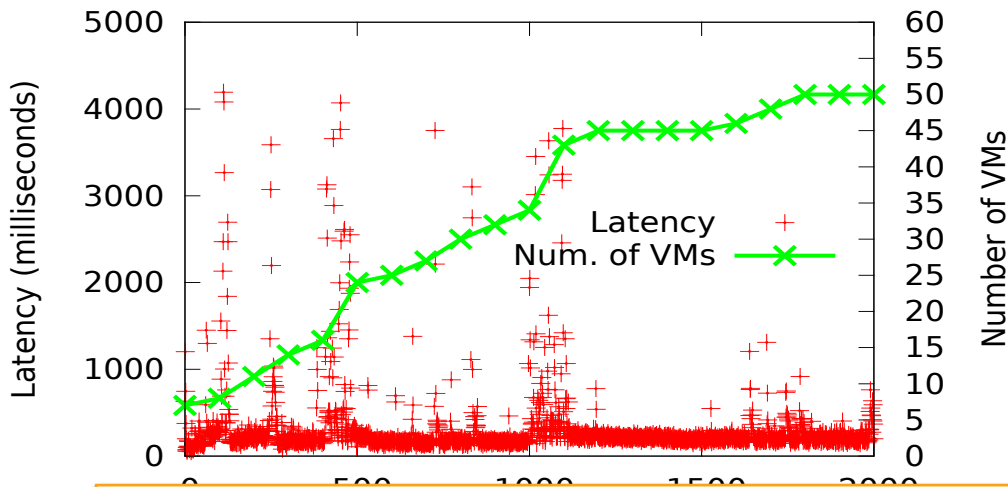

**scale out leads to latency peaks,  
but remains within LRB SLA**

SEEP scales out to increasing workload in the Linear Road Benchmark

# Conclusions

## **Stream processing will grow in importance:**

- handling the data deluge
- enables real-time response and decision making

## **Integrated approach for scale out and failure recovery:**

- operator state an independent entity
- primitives and mechanisms

## **Efficient approach extensible for additional operators:**

- effectively applied to Amazon EC2 running LRB
- parallel recovery