

[01] INTRODUCTION

1.1

OUTLINE

- Course Summary
- Recap
 - Encodings: Text, Numbers, Data Structures, Instructions
 - A Model Computer and the Fetch-Execute Cycle
 - Some IO Devices, Buses, Interrupts, DMA
- Key Concepts
 - Layering & Multiplexing
 - Synchronous & Asynchronous
 - Latency, Bandwidth, Jitter
 - Caching & Buffering
 - Bottlenecks, 80/20 Rule, Tuning
- Operating Systems
 - What is and is not an Operating System?
 - Evolution of Operating Systems

1.2

COURSE SUMMARY

I	Processor	
02	Protection	What is the OS protecting?
03	Processes	On what does the OS operate?
04	Scheduling	What does the OS run next?
05	Scheduling Algorithms	How does it choose?

II	Memory Management	
06	Virtual Addressing	How does the OS protect processes from each other?
07	Paging	How to manage virtual addresses from a machine perspective?
08	Segmentation	How to manage virtual addresses from a programmer perspective?

2.1

COURSE SUMMARY

III	Input/Output	
09	IO Subsystem	How does the OS interact with the outside world?
10	Storage	How does the OS manage persistence for processes?

IV	Case Study	
11	Unix I	Putting it together: Design, Filesystem
12	Unix II	Putting it together: IO, Processes, Shell

2.2

RECOMMENDED READING

- Tannenbaum, A.S., (1990) *Structured Computer Organization (3rd Ed.)* Prentice-Hall 1990
- Patterson, D., and Hennessy, J. (1998) *Computer Organization & Design (2nd Ed.)* Morgan Kaufmann
- Bacon, J. (1997) [and Harris, T. (2003)] *Concurrent Systems [or Operating Systems]*. Addison Wesley
- Silberschatz, A., Peterson, J., and Galvin, P. (1998) *Operating Systems Concepts (5th Ed.)* Addison Wesley
- Leffler, S. (1989). *The Design and Implementation of the 4.3BSD Unix Operating System* Addison-Wesley
- McKusick, M.K., Neville-Neil, G.N. & Watson, R.N.M. (2014) *The Design and Implementation of the FreeBSD Operating System (2nd Ed.)* Pearson Education

2.3

RECAP

- Course Summary
- Recap
 - Encodings: Text, Numbers, Data Structures, Instructions
 - A Model Computer and the Fetch-Execute Cycle
 - Some IO Devices, Buses, Interrupts, DMA
- Key Concepts
- Operating Systems

3.1

TEXT

Two main standards:

- ASCII: 7-bit code holding (American) letters, numbers, punctuation and a few other characters. Regional 8-bit variations. Competitors included EBCDIC (IBM; very odd, not all characters contiguous)
- Unicode: 8-, 12- or 32-bit code intended to support all international alphabets and symbols

ASCII used to be widespread default. Unicode now becoming popular (esp. UTF-8):

- Unicode 9.0 has 128,172 characters assigned out of potential 1,114,112 code points ($0_{16} - 10FFFF_{16}$)
- Commonly use the 8-bit transformation format called UTF-8; superset of ASCII which includes "enough" to get by for Roman languages and regional currency symbols, etc.

3.2

UTF-8

Low 128 bits map direct to ASCII which is useful for backward compatibility

Variable length: all other characters are encoded as $\langle len \rangle \langle codes \rangle$, where $0xC0 \leq len \leq 0xFD$ encoding the length, while $0x80 \leq codes \leq 0xFD$. Top two bytes unused. Also have UTF-16 and UTF-32.

Unicode distinguishes *character* (smallest meaningful semantic unit), *codepoint* (its encoding) and *glyph* (character rendering, including directionality, whether text should be displayed right-to-left, or top-to-bottom, etc.)

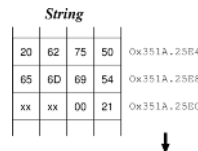

Both ASCII and Unicode are represented in memory as either strings or arrays: e.g. "Pub Time!" ($0x50 = 'P'$, $0x75 = 'u'$, etc)

Since $|\text{character}| < |\text{machine word size}|$, need to be careful with endianness. Example is little endian

3.3

NUMBERS

n -bit register $b_{n-1}b_{n-2} \dots b_1b_0$ can represent 2^n different values

- b_{n-1} termed the **Most Significant Bit** (MSB), and b_0 the **Least Significant Bit** (LSB)

Unsigned numbers: treat the obvious way, i.e.,

$$val = b_{n-1}2^{n-1} + b_{n-2}2^{n-2} + \dots + b_12^1 + b_02^0$$

e.g., $1101_2 = 2^3 + 2^2 + 2^0 = 8 + 4 + 1 = 13$

Represents values from 0 to 2^{n-1} inclusive. For large numbers, binary is unwieldy so use hexadecimal (base 16)

- To convert, group bits into groups of 4,
 - e.g., $1111101010_2 = 0011 | 1110 | 1010_2 = 3EA_{16}$
- Often use 0x prefix to denote hex, e.g., $0x107$
- Can use dot to separate large numbers into 16-bit chunks, e.g., $0x3FF.FFFF$

3.4

SIGNED NUMBERS

Two main options:

- Sign & magnitude:
 - Top (leftmost) bit flags if negative; remaining bits make value
 - E.g., 10011011_2 is $-0011011_2 = -27$
 - Represents range $-(2^{n-1} - 1)$ to $+(2^{n-1} - 1)$ and the bonus value -0 (!)
- 2's complement:
 - To get $-x$ from x , invert every bit and add 1
 - E.g., $+27 = 00011011_2$, $-27 = (11100100_2 + 1) = 11100101_2$
 - Treat $1000 \dots 000_2$ as -2^{n-1}
 - Represents range -2^{n-1} to $+(2^{n-1} - 1)$

3.5

FLOATING POINT

To handle very large or very small numbers, use scientific notation, e.g., $n = m \times 10^e$ with m the mantissa, e the exponent, e.g., $C = 3.01 \times 10^8$ m/s

For computers, use binary i.e. $n = m \times 2^e$, where m includes a "binary point"

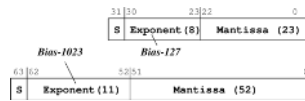

In practice use IEEE floating point with normalised mantissa $m = 1.xx \dots x_2$ i.e., use $n = (-1)^s((1 + m) \times 2^{e-b})$

IEEE floating point reserves $e = 0$ and $e = \text{max}$:

- m zero: $e = \text{max}$: $\pm\infty$; $e = 0$: ± 0 (!)
- m non-zero: $e = \text{max}$: NaNs; $e = 0$: denorms

Normal positive range $[2^{-126}, \sim 2^{128}]$ for single, or $[2^{-1022}, \sim 2^{1024}]$ for double

NB. still only 2^{32} or 2^{64} values – just spread out

3.6

DATA STRUCTURES

Not interpreted by machine – up to programmer (or compiler) where things go, and how

Fields in records/structures stored as an offset from a base address. In variable size structures, explicitly store addresses (pointers) inside structure, e.g.,

```
datatype rec = node of int * int * rec
           | leaf of int;
val example = node(4, 5, node(6, 7, leaf(8)));
```

If example is stored at address 0x1000:

0x0F34	8	Integer 8
...
0x0F3C	0xFFFFE	Constructor tag for a node
0x0F40	6	Integer 6
0x0F44	7	Integer 7
0x0F48	0x0F30	Address of inner node
...
0x1000	0xFFFFE	Constructor tag for a node
0x1004	4	Integer 4
0x1008	5	Integer 5
0x100C	0x0F3C	Address of inner node

3.7

ENCODING: INSTRUCTIONS

Instructions comprise:

- An **opcode**: specify what to do
- Zero or more **operands**: where to get values
- E.g., add r1, r2, r3

E.g., ARM ALU operations

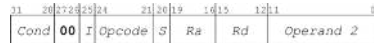

Range of options:

- Addressing mode (how to interpret operands) either part of opcode, or given explicitly
- Variable length encoding: may give better code density; makes it easier to extend instruction set (!)
- Huffman encoding looks at most probable instructions and assigns them the shortest opcodes; infrequently used instructions get long ones
- But! Makes decoding rather tricky, lose on PC-relative, bad for cache

3.8

A MODEL COMPUTER

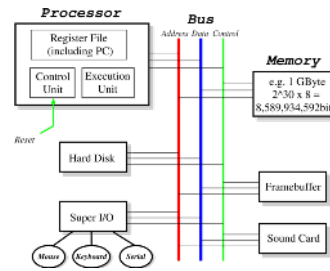

Processor (CPU) executes programs using:
Memory: stores both programs & data.
Devices: for input and output. **Bus**: transfers information

Computers operate on information in memory from input devices. Memory is a large byte array that holds any information on which we operate. Computer logically takes values from memory, performs operations, and then stores result back

CPU operates on registers, extremely fast pieces of on-chip memory, usually now 64-bits in size. Modern CPUs have between 8 and 128 registers. Data values are loaded from memory into registers before being operated upon, and results are stored back again

3.9

FETCH-EXECUTE CYCLE

CPU fetches & decodes instruction, generating control signals and operand information

Inside **Execution Unit** (EU), control signals select **Functional Unit** (FU) ("instruction class") and operation

If **Arithmetic Logic Unit** (ALU), then read one or two registers, perform operation, and (probably) write back result. If **Branch Unit** (BU), test condition and (maybe) add value to PC. If **Memory Access Unit** (MAU), generate address ("addressing mode") and use bus to read/write value

Repeat

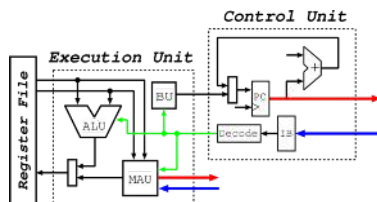

3.10

INPUT/OUTPUT DEVICES

Devices connected to processor via a bus (e.g., ISA, PCI, AGP):

- Mouse, Keyboard
- Graphics Card, Sound Card
- Floppy Drive, Hard Disk Drive, CD-ROM
- Network Card, Printer, Modem
- etc.

Often two or more stages involved (e.g., IDE, SCSI, RS-232, Centronics, etc.)

Connections may be indirect, e.g.,

- Graphics card (on bus) controls monitor (not on bus)

3.11

UNIVERSAL ASYNCHRONOUS RECEIVER/TRANSMITTER (UART)

Stores 1 or more bytes internally, converting parallel to serial

- Outputs according to RS-232
- Various baud rates (e.g., 1,200 – 115,200)
- Slow, simple, and **very useful**

Make up "serial ports" on PC

- Max throughput ~14.4kb/s; variants up to 56kb/s (for modems)
- Connect to terminal (or terminal emulation software) to debug device

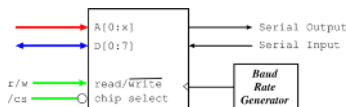

3.12

HARD DISKS

Whirling bits of metal, increasingly replaced by **Solid State Devices** (SSDs). Up to around 15,000 rpm, ~2TB per platter, ~2Gb/s

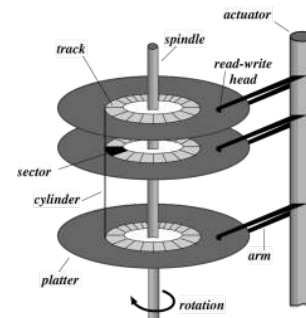

3.13

GRAPHICS CARDS

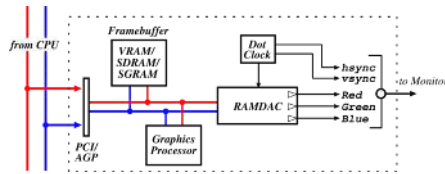

Essentially some RAM (**framebuffer**) and (older) some digital-to-analogue circuitry (**RAMDAC**)

- RAM holds array of pixels: picture elements
- Resolutions e.g., 640x480, 800x600, 1024x768, 1280x1024, 1600x1200, ...
- Depths: 8-bit (LUT), 16-bit (RGB=555), 24-bit (RGB=888), 32-bit (RGBA=888)
- Memory requirement = $x \times y \times \text{depth}$, e.g., 1280x1024 @ 16bpp needs 2560kB
- Full-screen 50Hz video requires 125 MB/s (or ~1Gb/s)

3.14

BUSES

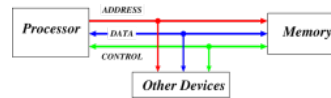

Collection of shared communication wires: low cost, versatile but potential bottleneck. Typically comprises **address lines** (determine how many devices on bus), **data lines** (determine how many bits transferred at once) and **control lines**,

plus power and ground. Operates in a master-slave manner, e.g.,

- Master decides to e.g., read some data
- Master puts address onto bus and asserts `read`
- Slave reads address from bus and retrieves data
- Slave puts data onto bus
- Master reads data from bus

Mean we don't need wires everywhere! Also can define bus protocol and then do plug'n'play

3.15

BUS HIERARCHY

In practice, many different buses with different characteristics, e.g., data width, max number of devices, max length. Most are **synchronous**, i.e. share a clock signal.

E.g., with four buses:

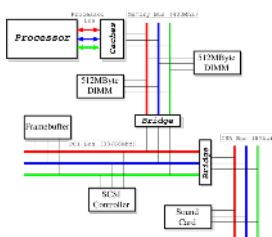

Processor bus: fastest (and widest?), for CPU to talk to cache

Memory bus: to communicate with memory

PCI and (E)ISA buses: to communicate with current and legacy devices

Bridges forwards from one side to the other; e.g., to access a device on ISA bus, processor generates magic [physical] address which goes to memory bridge, then to PCI bridge, and then to ISA bridge, and finally to ISA device. Same on the way back

3.16

INTERRUPTS

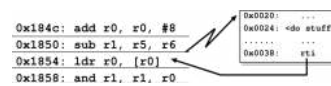

Bus reads and writes are transaction based: CPU requests something and waits until it happens. But, e.g., reading a block of data from a hard-disk might take ~2ms, which could be >5M clock cycles!

Interrupts provide a way to decouple CPU requests from device responses

- CPU uses bus to make a request (e.g., writes some special values to a device)
- Device fetches data while CPU continues doing other stuff
- Device raises an interrupt when it has data
- On interrupt, CPU vectors to handler, reads data from device, and resumes using special instruction, e.g., `r.t.i`

NB. Interrupts happen at any time but are deferred to an instruction boundary. Interrupt handlers must not trash registers, and must know where to resume. CPU thus typically saves values of all (or most) register, restoring with `r.t.i`

3.17

DIRECT MEMORY ACCESS (DMA)

Interrupts good but (e.g.) livelock a problem. Even better is a device which can read and write processor memory directly – enter **Direct Memory Access (DMA)**. A generic DMA "command" might include:

- Source address
- Source increment / decrement / do nothing
- Sink address
- Sink increment / decrement / do nothing
- Transfer size

Get just one interrupt at end of data transfer. DMA channels may be provided by dedicated DMA controller, or by devices themselves: e.g. a disk controller that passes disk address, memory address and size, and give instruction to read or write. All that's required is that a device can become a bus master. Scatter/Gather DMA chains requests, e.g., of disk reads into set of buffers

Complexities?

3.18

SUMMARY

Computers made up of four main parts:

1. Processor (including register file, control unit and execution unit)
2. Memory (caches, RAM, ROM)
3. Devices (disks, graphics cards, etc.)
4. Buses (interrupts, DMA)

Information represented in all sorts of formats:

- Strings
- Signed & unsigned integers
- Floating point
- Data structures
- Instructions

3.19

KEY CONCEPTS

- Course Summary
- Recap
- Key Concepts
 - Layering & Multiplexing
 - Synchronous & Asynchronous
 - Latency, Bandwidth, Jitter
 - Caching & Buffering
 - Bottlenecks, 80/20 Rule, Tuning
- Operating Systems

4.1

LAYERING

Layering is a means to manage complexity by controlling interactions between components. Arrange components in a stack, and restrict a component at layer X from relying on any other component except the one at layer $X-1$ and from providing service to any component except the one at layer $X+1$



MULTIPLEXING

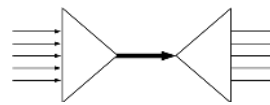

Traditionally a method by which multiple (analogue) signals are combined into a single signal over a shared medium. In this context, any situation where one resource is being consumed by multiple consumers simultaneously

Multiplexing diagram by The Anome – Own work. Licensed under CC BY-SA 3.0 via Wikimedia Commons

4.2

SYNCHRONOUS & ASYNCHRONOUS

Loosely, shared clock (**synchronous**) vs no shared clock (**asynchronous**). In networking, an asynchronous receiver needs to figure out for itself when the transfer starts and ends while a synchronous receiver has a channel over which that's communicated

In the case of Operating Systems, whether two components operate in lock-step: **synchronous IO** means the requester waits until the request is fulfilled before proceeding, while with **asynchronous IO**, the requester proceeds and later handles fulfilment of their request

4.3

LATENCY, BANDWIDTH, JITTER

Different metrics of concern to systems designers

Latency: How long something takes. E.g., "This read took 3 ms"

Bandwidth: The rate at which something occurs. E.g., "This disk achieves 2 Gb/s"

Jitter: The variation (statistical dispersal) in latency (frequency). E.g., "Scheduling was periodic with jitter +/- 50µsec"

Be aware whether it is the **absolute** or **relative** value that matters, and whether the **distribution** of values is also of interest

4.4

CACHING & BUFFERING

A common system design problem is to handle **impedance mismatch** – a term abused from electrical engineering – where two components are operating at different speeds (latencies, bandwidths). Common approaches are:

- **Caching**, where a small amount of higher-performance storage is used to mask the performance impact of a larger lower-performance component. Relies on **locality** in time (finite resource) and space (non-zero cost)
E.g., CPU has registers, L1 cache, L2 cache, L3 cache, main memory
- **Buffering**, where memory of some kind is introduced between two components to soak up small, variable imbalances in bandwidth. NB. Doesn't help if one component simply, on average, exceeds the other
E.g., A hard disk will have on-board memory into which the disk hardware reads data, and from which the OS reads data out

4.5

BOTTLENECKS, TUNING, 80/20 RULE

There is typically one resource that is most constrained in a system – the **bottleneck**

Performance optimisation and **tuning** focuses on determining and eliminating bottlenecks

- But often introduces new ones

A **perfectly balanced system** has all resources simultaneously bottlenecked

- Impossible to actually achieve

Often find that **optimising the common case** gets most of the benefit anyway

- Means that measurement is a prerequisite to performance tuning!
- The 80/20 rule – 80% time spent in 20% code
- If you highly optimise a very rare case, it'll make no difference

4.6

OPERATING SYSTEMS

- Course Summary
- Recap
- Key Concepts
- **Operating Systems**
 - **What is and is not an Operating System?**
 - **Evolution of Operating Systems**

5.1

WHAT IS AN OPERATING SYSTEM?

A program controlling the execution of all other programs

Objectives:

- **Convenience** – hide all the gunk we've just recapped
- **Efficiency** – only does articulation work so minimise overheads
- **Extensibility** – need to evolve to meet changing application demands and resource constraints

There's an analogy to a government: does no useful work, simply legislates on resource use by competing applications with the intent of achieving best function of system (society) through policy

(Also difficult to change and can be imposed on users without consent ;)

5.2

WHAT IS NOT AN OPERATING SYSTEM

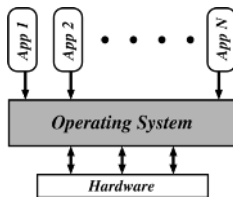

The Operating System (OS) controls all execution, multiplexes resources between applications, and abstracts away from complexity

Consider the last point particularly – typically involves libraries and tools provided as part of the OS, in addition to a kernel (e.g., `glibc` – but what about language runtime?). Thus no-one really agrees **precisely** what the OS is

For our purposes, focus on **the kernel**

5.3

IN THE BEGINNING...

First stored-program machine (EDSAC, 1949–1955), operated "open shop": user = programmer = operator. All programming in machine code. Users sign up for blocks of time to do development, debugging, etc. To reduce costs, hire a separate (relatively unskilled) operator: management happy, everyone else hates it. Also reduces "interactivity" so CPU utilisation reduces

BATCH SYSTEMS

Introduction of tape drives allow batching of jobs:

- Programmers put jobs on cards as before
- All cards read onto a tape
- Operator carries input tape to computer
- Results written to output tape
- Output tape taken to printer

5.4

SPOOLING SYSTEMS

Even better: spooling systems

- Spool jobs to tape for input to CPU, on a slower device not connected to CPU
- Interrupt driven IO
- Magnetic disk to cache input tape
- Fire operator

Computer now has a resident monitor:

- Initial control is in monitor, which reads job and transfers control
- End of job, control transfers back to monitor

Monitor now schedules jobs, so need job control language to separate jobs on tape and to allow jobs to pass control to the monitor on completion, e.g. FMS had `$JOB`, `$FTN`, `$RUN`, `$DATA`, `$END`, with `$FTN` being optional for assembly programs

But! Need to "trust" the job will give control back to monitor, and devices still slow compared to CPU...

5.5

MULTI-PROGRAMMING

Use memory to cache jobs from disk, meaning >1 job active (resident) simultaneously

Two stage scheduling: 1. select jobs to load: **job scheduling**; 2. select resident job to run: **CPU scheduling**. End up with one job computing while another waits for IO, causes competition for CPU and space in main memory

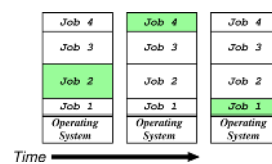

Batch Multi-Programming: extension of batch system to allow more than one job to be resident simultaneously

Users wanting more interaction leads to time-sharing:

- E.g., CTSS (first, in 1961), TSO, Unix, VMS, Windows NT, ...
- Use timesharing to develop code, then batch to run: give each user a teletype/terminal; interrupt on `return`; OS reads line and creates new job

5.6

MONOLITHIC OPERATING SYSTEMS

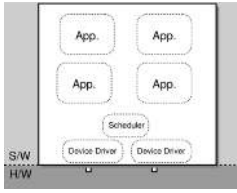

Oldest kind of OS structure ("modern" examples are DOS, original MacOS)

Applications and OS bound in a big lump, without clear interfaces. All OS provides is a simple abstraction layer, making it easier to write applications

Problem is, applications can trash the OS, other applications, lock the CPU, abuse IO, etc. Doesn't provide useful fault containment. Need a better solution...

5.7

OPERATING SYSTEM FUNCTIONS

Regardless of structure, OS needs to securely multiplex resources, i.e. to protect applications while sharing physical resources. Many OS design decisions are about where this line is drawn

Also usually want to abstract away from grungy hardware, i.e. OS provides a virtual machine to:

- Share CPU (in time) and provide each application with a virtual processor
- Allocate and protect memory, and provide applications with their own virtual address space
- Present a set of (relatively) hardware independent virtual devices
- Divide up storage space by using filing systems

Remainder of this part of the course will look at each of the above areas in turn

5.8

SUMMARY

- Course Summary
- Recap
 - Encodings: Text, Numbers, Data Structures, Instructions
 - A Model Computer and the Fetch-Execute Cycle
 - Some IO Devices, Buses, Interrupts, DMA
- Key Concepts
 - Layering & Multiplexing
 - Synchronous & Asynchronous
 - Latency, Bandwidth, Jitter
 - Caching & Buffering
 - Bottlenecks, 80/20 Rule, Tuning
- Operating Systems
 - What is and is not an Operating System?
 - Evolution of Operating Systems

6

[02] PROTECTION

1-1

OUTLINE

- Protection
 - Motivation, Requirements, Subjects & Objects
 - Design of Protection Systems
 - Covert Channels
- Low-level Mechanisms
 - IO, Memory, CPU
- OS Structures
 - Dual-mode Operation, Kernels & Microkernels
 - Mandatory Access Control, pledge (2)
- Authentication
 - User to System, System to User
 - Mutual Suspicion
- Access Matrix
 - Access Control Lists (ACLs) vs Capabilities

1-2

PROTECTION

- **Protection**
 - **Motivation, Requirements, Subjects & Objects**
 - **Design of Protection Systems**
 - **Covert Channels**
- Low-level Mechanisms
- OS Structures
- Authentication
- Access Matrix

2-1

WHAT ARE WE PROTECTING AGAINST?

Unauthorised release of information

- Reading or leaking data
- Violating privacy legislation
- Covert channels, traffic analysis

Unauthorised modification of information

- Changing access rights
- Can do sabotage without reading information

(Unauthorised) denial of service

- Causing a crash
- Causing high load (e.g. processes or packets)

Also protection against effects of errors: e.g., isolate for debugging, damage control

Impose controls on access by **subjects** (e.g. users) to **objects** (e.g. files)

2-2

COVERT CHANNELS

Information leakage by side-effects: lots of fun! At the hardware level:

- Wire tapping
- Monitor signals in machine
- Modification to hardware
- Electromagnetic radiation of devices

By software:

- File exists or not
- Page fault or not
- Compute or sleep
- 1 or 0
- System provided statistics

E.g., lowest layer of recent OCaml TLS library in C to avoid side channel through garbage collector

2-3

ASPECTS OF PROTECTION SYSTEM

Physical, e.g.,

- Lock the computer room
- Restrict access to system software

Social, e.g.,

- De-skill systems operating staff
- Keep designers away from final system!
- Legislate

Technical, e.g.,

- Use passwords (in general challenge/response)
- Use encryption

2-4

DESIGN OF PROTECTION SYSTEMS

From [Saltzer & Schroeder, Proc. IEEE, September 1975]:

- Design should be public
- Default should be no access
- Check for current authority
- Give each process minimum possible authority
- Mechanisms should be simple, uniform and built in to lowest layers
- Should be psychologically acceptable
- Cost of circumvention should be high
- Minimize shared access

2-5

LOW-LEVEL PROTECTION

- Protection
- **Low-level Mechanisms**
 - **IO, Memory, CPU**
- OS Structures
- Authentication
- Access Matrix

3-1

PROTECTING IO & MEMORY

Initially, try to make IO instructions privileged:

- Applications can't mask interrupts (that is, turn one or many off)
- Applications can't control IO devices

But!

- Some devices are accessed via memory, not special instructions
- Applications can rewrite interrupt vectors

Hence protecting IO means also protecting memory, e.g. define a base and a limit for each program, and protect access outside allowed range

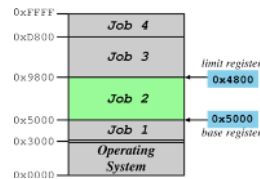

3-2

IMPLEMENTING MEMORY PROTECTION

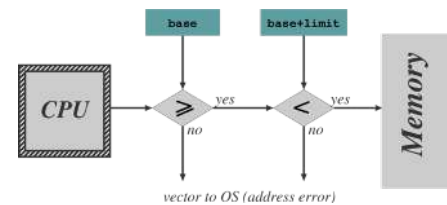

Have hardware check every memory reference:

- Access out of range causes vector into OS (as for an interrupt)
- Only allow update of base and limit registers when in kernel mode
- May disable memory protection in kernel mode (although a bad idea)

In reality, more complex protection hardware is used (see *Paging* and *Segmentation*)

3-3

PROTECTING THE CPU

Need to ensure that the OS stays in control:

- I.e., must prevent any application from "hogging" the CPU the whole time
- Means using a timer, usually a countdown timer, e.g.,
 - Set timer to initial value (e.g. 0xFFFF)
 - Every tick (e.g. 1 μ s or, nowadays, programmable), timer decrements value
 - When value hits zero, interrupt
- Ensures the OS runs periodically

Requires that only OS can load timer, and that interrupt cannot be masked:

- Use same scheme as for other devices
- Re-use to implement time-sharing (later)

3-4

OS STRUCTURES

- Protection
- Low-level Mechanisms
- **OS Structures**
 - **Dual-mode Operation, Kernels & Microkernels**
 - **Mandatory Access Control, p1edge (2)**
- Authentication
- Access Matrix

4-1

DUAL-MODE OPERATION

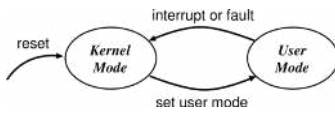

Simply want to stop buggy (or malicious) program from doing bad things

- Trust boundary between user **application** and the **OS**
- Use hardware support to differentiate between (at least) two modes of operation
 1. User Mode : when executing on behalf of a user (i.e. application programs).
 2. Kernel Mode : when executing on behalf of the OS
- Make certain instructions only possible in kernel mode, indicated by **mode bit**

E.g., x86: Rings 0–3, ARM has seven modes including **IRQ** and **FIQ**

Often "nested" (per x86 rings): further inside can do strictly more. Not ideal – e.g., stop kernel messing with applications – but disjoint/overlapping permissions hard

4-2

KERNEL-BASED OPERATING SYSTEMS

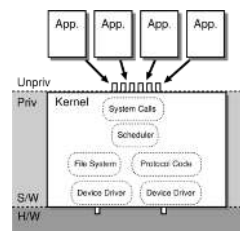

Applications can't do IO due to protection so the OS does it on their behalf

This means we need a secure way for application to invoke OS: a special (unprivileged) instruction to transition from user to kernel mode

Generally called a **trap** or a **software interrupt** since operates similarly to (hardware) interrupt...

OS services accessible via software interrupt mechanism called **system calls**

OS has vectors to handle traps, preventing application from leaping to kernel mode and then just doing whatever it likes

Alternative is for OS to emulate for application, and check every instruction, as used in some virtualization systems, e.g., **QEMU**

4-3

MICROKERNEL OPERATING SYSTEMS

We've protected "privileged instructions" via dual-mode operation, memory via special hardware, and the CPU via use of a timer. But now applications can't do much directly and must use OS to do it on their behalf

OS must be very stable to support apps, so becomes hard to extend

Alternative is **microkernels**: move OS services into (local) servers, which may be privileged

Increases both modularity and extensibility

Still access kernel via system calls, but need new ways to access servers: **Inter-Process Communication (IPC)** schemes

Given talking to servers (largely) replaces trapping, need IPC schemes to be extremely efficient

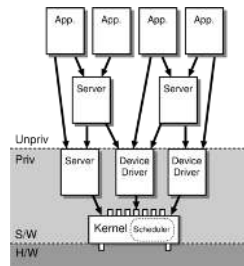

4-4

KERNELS VS MICROKERNELS

So why isn't everything a microkernel?

- Lots of IPC adds overhead, so microkernels (perceived as) usually performing less well
- Microkernel implementation sometimes tricky: need to worry about synchronisation
- Microkernels often end up with redundant copies of OS data structures

Thus many common OSs blur the distinction between kernel and microkernel.

- E.g. Linux is "kernel", but has kernel modules and certain servers.
- E.g. Windows NT was originally microkernel (3.5), but now (4.0 onwards) pushed lots back into kernel for performance
- Unclear what the best OS structure is, or how much it really matters...

4-5

VIRTUAL MACHINES AND CONTAINERS

More recently, trend towards encapsulating applications differently. Roughly aimed towards making applications appear as if they're the only application running on the system. Particularly relevant when building systems using **microservices**. Protection, or **isolation** at a different level

- **Virtual Machines** encapsulate an entire running system, including the OS, and then boot the VM over a hypervisor
E.g., Xen, VMWare ESX, Hyper-V
- **Containers** expose functionality in the OS so that each container acts as a separate entity even though they all share the same underlying OS functionality
E.g., Linux Containers, FreeBSD Jails, Solaris Zones

4-6

MANDATORY ACCESS CONTROL

From a user point of view, nowadays one often wants to protect applications from each other, all owned by a single user. Indeed, with personal single-user machines now common (phones, tablets, laptops), arguable that protection model is mismatched

Mandatory Access Control (MAC) mandates expression of policies constraining interaction of system users

E.g., OSx and iOS *Sandbox* uses subject/object labelling to implement access-control for privileges and various resources (filesystem, communication, APIs, etc)

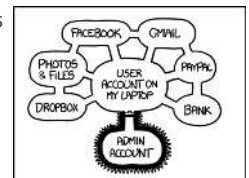

IF SOMEONE STEALS MY LAPTOP WHILE I'M LOGGED IN, THEY CAN REND MY EMAIL, TAKE MY MONEY AND IMPERSONATE ME TO MY FRIENDS, BUT AT LEAST THEY CAN'T INSTALL DRIVERS WITHOUT MY PERMISSION.

4-7

PLEDGE (2)

One way to reduce the ability of a compromised program to do Bad Things™ is to remove access to unnecessary system calls

Several attempts in different systems, with varying (limited) degrees of success:

- Hard to use correctly (e.g., Capsicum), or
- Introduce another component that needs to be watched (e.g., `seccomp`)

Observation:

- Most programs follow a pattern of `initialization()` then `main_loop()`, and
- The `main_loop()` typically uses a much narrower class of system calls than `initialization()`

Result? `pledge(2)` – ask the programmer to indicate explicitly which classes of system call they wish to use at any point, e.g., `stdio`, `route`, `inet`

4.8

AUTHENTICATION

- Protection
- Low-level Mechanisms
- OS Structures
- **Authentication**
 - User to System, System to User
 - Mutual Suspicion
- Access Matrix

5.1

AUTHENTICATING USER TO SYSTEM

Current practice: passwords

- But people pick badly
- And what about security of password file?
 - Restrict access to `login` programme (CAP, TITAN)
 - Store scrambled (Unix) using one-way function
- Often now prefer key-based systems (e.g., SSH)

E.g., in Unix:

- Password is DES-encrypted 25 times using a 2-byte per-user "salt" to produce a 11 byte string
- Salt followed by these 11 bytes are then stored

Enhance with: biometrics, smart cards, etc.

- ...though most of these can be stolen

5.2

AUTHENTICATING USER TO SYSTEM

<https://xkcd.com/936/>

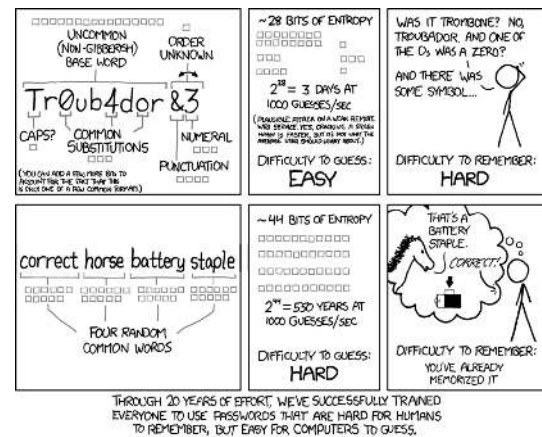

5.3

AUTHENTICATION OF SYSTEM TO USER

Want to avoid user talking to:

- Wrong computer
- Right computer, but not the login program

Partial solution in old days for directly wired terminals:

- Make login character same as terminal attention, or
- Always do a terminal attention before trying login
- E.g., Windows NT's `Ctrl-Alt-De1` to login – no-one else can trap it

But, today micros used as terminals

- Local software may have been changed – so carry your own copy of the terminal program
- ...but hardware / firmware in public machine may also have been modified
- Wiretapping is easy

(When your bank phones, how do you know it's them?)

5.4

MUTUAL SUSPICION

Encourage lots and lots of suspicion:

- System of user
- Users of each other
- User of system

Also, called programs should be suspicious of caller

- E.g., OS calls always need to check parameters

And caller should be suspicious of called program

- E.g., Trojan horse: a "useful" looking program, a game perhaps, inherits user privileges when called
- Can then copy files, modify files, change password, send mail, etc...
- E.g. Multics editor trojan horse, copied files as well as edited.

5.5

ACCESS MATRIX

- Protection
- Low-level Mechanisms
- OS Structures
- Authentication
- **Access Matrix**
 - **Access Control Lists (ACLs) vs Capabilities**

6.1

ACCESS MATRIX

A matrix of **subjects** against **objects**.

Subject (or **principal**) might be:

- Users e.g. by UID, or sets thereof
- Executing process in a protection domain, or sets thereof

Objects are things like:

- Files, devices
- Domains, processes
- Message ports (in microkernels)

Matrix is large and sparse so don't store it all. Two common representations:

1. By *object* (**Access Control List**): store list of subjects and rights with each object
2. By *subject* (**Capabilities**): store list of objects and rights with each subject

6.2

ACCESS CONTROL LISTS

Often used in storage systems:

- System naming scheme provides for ACL to be inserted in naming path, e.g. files
- If ACLs stored on disk, check is made in software, so use only on low duty cycle
- For higher duty cycle must cache results of check
- E.g. Multics: open file is a memory "segment" (see later) – on first reference, causes a fault which raises an interrupt which allows OS to check against ACL

ACL is checked when file opened for read or write, or when code file is to be executed

In (e.g.) Unix, access control is by program, allowing arbitrary policies

6.3

CAPABILITIES

Associated with active subjects, so:

- Store in address space of subject
- Must make sure subject can't forge capabilities
- Easily accessible to hardware
- Can be used with high duty cycle e.g. as part of addressing hardware

Hardware capabilities:

- Have special machine instructions to modify (restrict) capabilities
- Support passing of capabilities on procedure (program) call

Software capabilities:

- Checked by encryption
- Nice for distributed systems

6.4

SUMMARY

- Protection
 - Motivation, Requirements, Subjects & Objects
 - Design of Protection Systems
 - Covert Channels
- Low-level Mechanisms
 - IO, Memory, CPU
- OS Structures
 - Dual-mode Operation, Kernels & Microkernels
 - Mandatory Access Control, `pledge(2)`
- Authentication
 - User to System, System to User
 - Mutual Suspicion
- Access Matrix
 - Access Control Lists (ACLs) vs Capabilities

7

[03] PROCESSES

1.1

OUTLINE

- Process Concept
 - Relationship to a Program
 - What is a Process?
- Process Lifecycle
 - Creation
 - Termination
 - Blocking
- Process Management
 - Process Control Blocks
 - Context Switching
 - Threads
- Inter-Process Communication
 - Requirements
 - Concept
 - Mechanisms

1.2

PROCESS CONCEPTS

- Process Concept
 - Relationship to a Program
 - What is a Process?
- Process Lifecycle
- Process Management
- Inter-Process Communication

2.1

WHAT IS A PROCESS?

The computer is there to execute programs, not the operating system!

Process \neq Program

- A program is **static**, on-disk
- A process is **dynamic**, a program *in execution*

On a batch system, might refer to *jobs* instead of processes

2.2

WHAT IS A PROCESS?

Unit of protection and resource allocation

- So you may have multiple copies of a process running
- Each process executed on a *virtual processor*

Has a virtual address space (later)

Has one or more threads, each of which has

1. **Program Counter**: which instruction is executing
2. **Stack**: temporary variables, parameters, return addresses, etc.
3. **Data Section**: global variables shared among threads

2.3

PROCESS STATES



- **New**: being created
- **Running**: instructions are being executed
- **Ready**: waiting for the CPU, ready to run
- **Blocked**: stopped, waiting for an event to occur
- **Exit**: has finished execution

2.4

PROCESS LIFECYCLE

- Process Concept
- **Process Lifecycle**
 - Creation
 - Termination
 - Blocking
- Process Management
- Inter-Process Communication

3.1

PROCESS CREATION

*Nearly all systems are hierarchical:
parent processes create child processes*

- Resource sharing:
 - Parent and children share all resources
 - Children share subset of parent's resources
 - Parent and child share no resources

3.2

PROCESS CREATION

*Nearly all systems are hierarchical:
parent processes create child processes*

- Resource sharing
- Execution:
 - Parent and children execute concurrently
 - Parent waits until children terminate

3.3

PROCESS CREATION

*Nearly all systems are hierarchical:
parent processes create child processes*

- Resource sharing
- Execution
- Address space:
 - Child duplicate of parent
 - Child has a program loaded into it

3.4

EXAMPLES

Unix:

- `fork()` system call creates a child process, cloned from parent; then
- `execve()` system call used to replace the process' memory space with a new program

NT/2K/XP:

- `CreateProcess()` system call includes name of program to be executed

3.5

PROCESS TERMINATION

Occurs under three circumstances

1. Process executes last statement and asks the OS to delete it (`exit`):
 - Output data from child to parent (`wait`)
 - Process' resources are deallocated by the OS

3.6

PROCESS TERMINATION

Occurs under three circumstances

1. Process executes last statement and asks the OS to delete it
2. Process performs an illegal operation, e.g.,
 - Makes an attempt to access memory to which it is not authorised
 - Attempts to execute a privileged instruction

3.7

PROCESS TERMINATION

Occurs under three circumstances

1. Process executes last statement and asks the OS to delete it
2. Process performs an illegal operation
3. Parent may terminate execution of child processes (`abort`, `kill`), e.g. because
 - Child has exceeded allocated resources
 - Task assigned to child is no longer required
 - Parent is exiting ("cascading termination")

EXAMPLES

Unix: `wait()`, `exit()` and `kill()`

NT/2K/XP: `ExitProcess()` for self, `TerminateProcess()` for others

3.8

BLOCKING

- In general a process blocks on an event, e.g.,
 - An IO device completes an operation
 - Another process sends a message
- Assume OS provides some kind of general-purpose blocking primitive, e.g., `await()`
- Need care handling concurrency issues, e.g.,

```
if(no key being pressed) {
    await(keypress);
    print("Key has been pressed\n");
}
// handle keyboard input
```

- What happens if a key is pressed at the first `{`?
- Complicated! For next year...)

3.9

CPU IO BURST CYCLE

- Process execution consists of a cycle of CPU execution and IO wait
- Processes can be described as either:
 1. **IO-bound:**
 - spends more time doing IO than computation
 - many short CPU bursts
 2. **CPU-bound:**
 - spends more time doing computations
 - a few, very long, CPU bursts

3.10

CPU IO BURST CYCLE

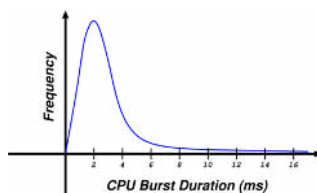

Observe that most processes execute for at most a few milliseconds before blocking

We need multiprogramming to obtain decent overall CPU utilisation

3.11

PROCESS MANAGEMENT

- Process Concept
- Process Lifecycle
- **Process Management**
 - **Process Control Blocks**
 - **Context Switching**
 - **Threads**
- Inter-Process Communication

4.1

PROCESS CONTROL BLOCK

OS maintains information about every process in a data structure called a *process control block* (PCB). The *Process Context* (highlighted) is the machine environment during the time the process is actively using the CPU:

- Program counter
- General purpose registers
- Processor status register
- [Caches, TLBs, Page tables, ...]

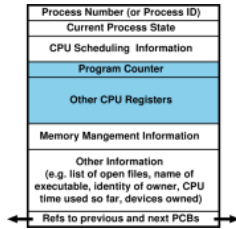

4.2

CONTEXT SWITCHING

- To switch between processes, the OS must:
 - Save the context of the currently executing process (if any), and
 - Restore the context of that being resumed.
- Note this is *wasted time* – no useful work is carried out while switching
- Time taken depends on hardware support
 - From nothing, to
 - Save/load multiple registers to/from memory, to
 - Complete hardware "task switch"

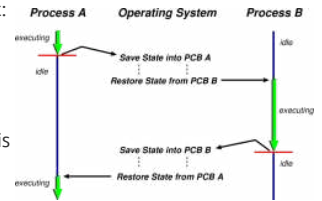

THREADS

A **thread** represents an individual execution context

Threads are managed by a **scheduler** that determines which thread to run

Each thread has an associated **Thread Control Block** (TCB) with metadata about the thread: saved context (registers, including stack pointer), scheduler info, etc.

Context switches occur when the OS saves the state of one thread and restores the state of another. If between threads in different processes, process state also switches

Threads visible to the OS are **kernel threads** – may execute in kernel or address user space

4.4

INTER-PROCESS COMMUNICATION

- Process Concept
- Process Lifecycle
- Process Management
- **Inter-Process Communication**
 - Requirements
 - Concept
 - Mechanisms

5.1

REQUIREMENTS

For meaningful communication to take place, two or more parties have to exchange information according to a **protocol**:

- Data transferred must be in a commonly-understood format (**syntax**)
- Data transferred must have mutually-agreed meaning (**semantics**)
- Data must be transferred according to mutually understood rules (**synchronisation**)

In computer communications, the parties in question come in a range of forms, typically:

- Threads
- Processes
- Hosts

Ignore problems of discovery, identification, errors, etc. for now

5.2

INTER-PROCESS COMMUNICATION

In the context of this course, we are concerned with **Inter-Process Communication** (IPC)

- What it says on the tin – communication between processes on the same host
- Key point – it is possible to *share memory* between those processes

Given the protection boundaries imposed by the OS, by design, the OS must be involved in any communication between processes

- Otherwise it would be tantamount to allowing one process to write over another's address space
- We'll focus on POSIX mechanisms

5.3

INTER-THREAD COMMUNICATION

It is a common requirement for two running threads to need to communicate

- E.g., to coordinate around access to a shared variable

If coordination is not implemented, then all sorts of problems can occur. Range of mechanisms to manage this:

- Mutexes
- Semaphores
- Monitors
- Lock-Free Data Structures
- ...

Not discussed here!

- You'll get into the details next year in **Concurrent and Distributed Systems**
- (Particularly the first half, on *Concurrency*)

5.4

INTER-HOST COMMUNICATION

Passing data between different hosts:

- Traditionally different physical hosts
- Nowadays often virtual hosts

Key distinction is that there is now no shared memory, so some form of transmission medium must be used – **networking**

Also not discussed here!

- In some sense it is "harder" than IPC because real networks are inherently:
 - **Unreliable**: data can be lost
 - **Asynchronous**: even if data is not lost, no guarantees can be given about when it arrived
- You'll see a lot more of this next year in **Computer Networking**

5.5

CONCEPT

For IPC to be a thing, first you need multiple processes

- Initially created by running processes from a shell
- Subsequently may be created by those processes, ad infinitum
- (...until your machine dies from your fork bomb...)

Basic process mechanisms: `fork(2)` followed by `execve(2)` and/or `wait(2)`

Will look at that plus several other common POSIX mechanisms

5.6

FORK(2), WAIT(2)

Simply put, `fork(2)` allows a process to clone itself:

- **Parent** process creates **child** process
- Child receives copy-on-write (COW) snapshot of parent's address space

Parent typically then either:

- Detaches from child – hands responsibility back to `init` process
- Waits for child – calling `wait(2)`, parent blocks until child exits

5.7

SIGNALS

Simple asynchronous notifications on another process

- A range of signals (28 at my last count), defined as numbers
- Mapped to standard `#defines`, a few of which have standard mappings to numbers

Among the more common ones:

- `SIGHUP`: hangup the terminal (1)
- `SIGINT`: terminal interrupt (2)
- `SIGKILL`: terminate the process [cannot be caught or ignored] (9)
- `SIGTERM`: terminate process (15)
- `SIGSEGV`: segmentation fault – process made an invalid memory reference
- `SIGUSR1/2`: two user signals [system defined numbers]

Use `sigaction(2)` to specify what function the signalled process should invoke on receipt of a given signal

5.8

PIPES

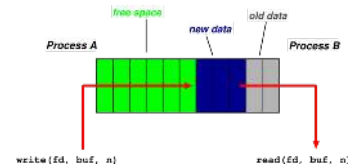

Simplest form of IPC: `pipe(2)` returns a pair of **file descriptors**

- `(fd[0], fd[1])` are the (read, write) fds

Coupled with `fork(2)`, can now communicate between processes:

- Invoke `pipe(2)` to get read/write fds
- `fork(2)` to create child process
- Parent and child then both have read/write fds available, and can communicate

5.9

NAMED PIPES / FIFOs

The same as `pipe(2)` – except that it has a name, and isn't just an array of two `fds`

- This means that the two parties can coordinate without needing to be in a parent/child relationship
- All they need is to share the (path)name of the FIFO

Then simply treat as a file:

- `open(2)`
- `read(2)`
- `write(2)`

`open(2)` will block by default, until some other process opens the FIFO for reading

- Can set non-blocking via `O_NDELAY`

5.10

SHARED MEMORY SEGMENTS

What it says on the tin – obtain a segment of memory that is shared between two (or more) processes

- `shmget(2)` to get a segment
- `shmat(2)` to attach to it

Then read and write simply via pointers – need to impose concurrency control to avoid collisions though

Finally:

- `shmdt(2)` to detach
- `shmctl(2)` to destroy once you know no-one still using it

5.11

FILES

Locking can be mandatory (enforced) or advisory (cooperative)

- Advisory is more widely available
- `flock(2)` sets, tests and clears the lock status
- Processes can then coordinate over access to files
- `read(2)`, `write(2)`, `seek(2)` to interact and navigate

Memory Mapped Files present a simpler – and often more efficient – API

- `mmap(2)` "maps" a file into memory so you interact with it via a pointer
- Still need to lock or use some other concurrency control mechanism

5.12

UNIX DOMAIN SOCKETS

Sockets are commonly used in network programming – but there is (effectively) a shared memory version for use between local processes, having the same API:

- `socket(2)` creates a socket, using `AF_UNIX`
- `bind(2)` attaches the socket to a file
- The interact as with any socket
 - `accept(2)`, `listen(2)`, `recv(2)`, `send(2)`
 - `sendto(2)`, `recvfrom(2)`

Finally, `socketpair(2)` uses sockets to create a full-duplex pipe

- Can read/write from both ends

5.13

SUMMARY

- Process Concept
 - Relationship to a Program
 - What is a Process?
- Process Lifecycle
 - Creation
 - Termination
 - Blocking
- Process Management
 - Process Control Blocks
 - Context Switching
 - Threads
- Inter-Process Communication
 - Requirements
 - Concept
 - Mechanisms

6

[04] SCHEDULING

OUTLINE

- Scheduling Concepts
 - Queues
 - Non-preemptive vs Preemptive
 - Idling
- Scheduling Criteria
 - Utilisation
 - Throughput
 - Turnaround, Waiting, Response Times

1.1

1.2

SCHEDULING CONCEPTS

- Scheduling Concepts
 - Queues
 - Non-preemptive vs Preemptive
 - Idling
- Scheduling Criteria

2.1

QUEUES

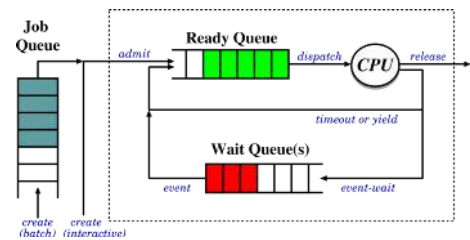

- **Job Queue**: batch processes awaiting admission
- **Ready Queue**: processes in main memory, ready and waiting to execute
- **Wait Queue(s)**: set of processes waiting for an IO device (or for other processes)
 - **Job** scheduler selects processes to put onto the ready queue
 - **CPU** scheduler selects process to execute next and allocates CPU

2.2

PREEMPTIVE VS NON-PREEMPTIVE

*OS needs to select a ready process and allocate it the CPU
When?*

- ...a running process blocks (running → blocked)
- ...a process terminates (running → exit)

If scheduling decision is only taken under these conditions, the scheduler is said to be **non-preemptive**

- ...a timer expires (running → ready)
- ...a waiting process unblocks (blocked → ready)

Otherwise it is **preemptive**

2.3

NON-PREEMPTIVE

- Simple to implement:
 - No timers, process gets the CPU for as long as desired
- Open to *denial-of-service*:
 - Malicious or buggy process can refuse to yield

Typically includes an *explicit yield* system call or similar, plus *implicit* yields, e.g., performing IO, waiting

Examples: MS-DOS, Windows 3.11

2.4

PREEMPTIVE

- Solves denial-of-service:
 - OS can simply preempt long-running process
- More complex to implement:
 - Timer management, concurrency issues

Examples: Just about everything you can think of :)

2.5

IDLING

We will usually assume that there's always something ready to run. But what if there isn't?

This is quite an important question on modern machines where the common case is >50% idle

2.6

IDLING

Three options

1. Busy wait in scheduler, e.g., Windows 9x
 - Quick response time
 - Ugly, useless

2.7

IDLING

Three options

1. Busy wait in scheduler
2. Halt processor until interrupt arrives, e.g., modern OSs
 - Saves power (and reduces heat!)
 - Increases processor lifetime
 - Might take too long to stop and start

2.8

IDLING

Three options

1. Busy wait in scheduler
2. Halt processor until interrupt arrives
3. Invent an idle process, always available to run
 - Gives uniform structure
 - Could run housekeeping
 - Uses some memory
 - Might slow interrupt response

In general there is a trade-off between responsiveness and usefulness. Consider the important resources and the system complexity

2.9

SCHEDULING CRITERIA

- Scheduling Concepts
- **Scheduling Criteria**
 - **Utilisation**
 - **Throughput**
 - **Turnaround, Waiting, Response Times**

3.1

SCHEDULING CRITERIA

Typically one expects to have more than one option – more than one process is runnable

On what basis should the CPU scheduler make its decision?

Many different metrics may be used, exhibiting different trade-offs and leading to different operating regimes

3.2

CPU UTILISATION

Maximise the fraction of the time the CPU is actively being used

Keep the (expensive?) machine as busy as possible

But may penalise processes that do a lot of IO as they appear to result in the CPU not being used

3.3

THROUGHPUT

Maximise the number of processes that complete their execution per time unit

Get useful work completed at the highest rate possible

But may penalise long-running processes as short-run processes will complete sooner and so are preferred

3.4

TURNAROUND TIME

Minimise the amount of time to execute a particular process

Ensures every processes complete in shortest time possible

3.5

WAITING TIME

Minimise the amount of time a process has been waiting in the ready queue

Ensures an interactive system remains as responsive as possible

But may penalise IO heavy processes that spend a long time in the wait queue

3.6

RESPONSE TIME

Minimise the amount of time it takes from when a request was submitted until the first response is produced

Found in time-sharing systems. Ensures system remains as responsive to clients as possible under load

But may penalise longer running sessions under heavy load

3.7

SUMMARY

- Scheduling Concepts
 - Queues
 - Non-preemptive vs Preemptive
 - Idling
- Scheduling Criteria
 - Utilisation
 - Throughput
 - Turnaround, Waiting, Response Times

4

[05] SCHEDULING ALGORITHMS

OUTLINE

- First-Come First-Served
- Shortest Job First
- Shortest Response Time First
- Predicting Burst Length
- Round Robin
- Static vs Dynamic Priority

FIRST-COME FIRST-SERVED (FCFS)

Simplest possible scheduling algorithm, depending only on the order in which processes arrive

E.g. given the following demand:

Process	Burst Time
P_1	25
P_2	4
P_3	7

EXAMPLE: FCFS

Consider the average waiting time under different arrival orders

P_1, P_2, P_3 :

- Waiting time $P_1 = 0, P_2 = 25, P_3 = 29$
- Average waiting time: $\frac{(0+25+29)}{3} = 18$

P_3, P_2, P_1 :

- Waiting time $P_1 = 11, P_2 = 7, P_3 = 0$
- Average waiting time: $\frac{(11+7+0)}{3} = 6$

Arriving in reverse order is *three times as good!*

- The first case is poor due to the **convoy effect**: later processes are held up behind a long-running first process
- FCFS is simple but not terribly robust to different arrival processes

SHORTEST JOB FIRST (SJF)

Intuition from FCFS leads us to *shortest job first* (SJF) scheduling

- Associate with each process the length of its next CPU burst
- Use these lengths to schedule the process with the shortest time
- Use, e.g., FCFS to break ties

EXAMPLE: SJF

Process	Arrival Time	Burst Time
P_1	0	7
P_2	2	4
P_3	4	1
P_4	5	4

Waiting time for $P_1 = 0, P_2 = 6, P_3 = 3, P_4 = 7$. Average waiting time: $\frac{(0+6+3+7)}{4} = 4$

SJF is optimal with respect to average waiting time:

- It minimises average waiting time for a given set of processes
- What might go wrong?

SHORTEST REMAINING-TIME FIRST (SRTF)

Simply a preemptive version of SJF: preempt the running process if a new process arrives with a CPU burst length less than the remaining time of the current executing process

2.5

EXAMPLE: SRTF

As before:

Process	Arrival Time	Burst Time
P_1	0	7
P_2	2	4
P_3	4	1
P_4	5	4

Waiting time for $P_1 = 9, P_2 = 1, P_3 = 0, P_4 = 2$

Average waiting time: $\frac{(9+1+0+2)}{4} = 3$

2.6

EXAMPLE: SRTF

Surely this is optimal in the face of new runnable processes arriving? Not necessarily – why?

- Context switches are not free: many very short burst length processes may thrash the CPU, preventing useful work being done
- More fundamentally, we can't generally know what the **future** burst length is!

2.7

PREDICTING BURST LENGTHS

- For both SJF and SRTF require the next "burst length" for each process means we must estimate it
- Can be done by using the length of previous CPU bursts, using exponential averaging:

- t_n = actual length of n^{th} CPU burst.
- τ_{n+1} = predicted value for next CPU burst.
- For $\alpha, 0 \leq \alpha \leq 1$ define:

$$\tau_{n+1} = \alpha t_n + (1 - \alpha)\tau_n$$

2.8

PREDICTING BURST LENGTHS

- If we expand the formula we get:

$$\tau_{n+1} = \alpha t_n + \dots + (1 - \alpha)^j \alpha t_{n-j} + \dots + (1 - \alpha)^{n+1} \tau_0$$

where τ_0 is some constant

- Choose value of α according to our belief about the system, e.g., if we believe history irrelevant, choose $\alpha \approx 1$ and then get $\tau_{n+1} \approx t_n$
- In general an exponential averaging scheme is a good predictor if the variance is small
- Since both α and $(1 - \alpha)$ are less than or equal to one, each successive term has less weight than its predecessor
- NB. Need some consideration of load, else get (counter-intuitively) increased priorities when increased load

2.9

ROUND ROBIN

A preemptive scheduling scheme for time-sharing systems.

- Define a small fixed unit of time called a quantum (or time-slice), typically 10 – 100 milliseconds
- Process at the front of the ready queue is allocated the CPU for (up to) one quantum
- When the time has elapsed, the process is preempted and appended to the ready queue

2.10

ROUND ROBIN: PROPERTIES

Round robin has some nice properties:

- Fair: given n processes in the ready queue and time quantum q , each process gets $1/n^{\text{th}}$ of the CPU
- Live: no process waits more than $(n - 1)q$ time units before receiving a CPU allocation
- Typically get higher average turnaround time than SRTF, but better average response time

But tricky to choose the correct size quantum, q :

- q too large becomes FCFS/FIFO
- q too small becomes context switch overhead too high

2.11

PRIORITY SCHEDULING

Associate an (integer) priority with each process, e.g.,

Prio	Process type
0	system internal processes
1	interactive processes (staff)
2	interactive processes (students)
3	batch processes

Simplest form might be just system vs user tasks

2.12

PRIORITY SCHEDULING

- Then allocate CPU to the highest priority process: "highest priority" typically means smallest integer
 - Get preemptive and non-preemptive variants
 - E.g., SJF is a priority scheduling algorithm where priority is the predicted next CPU burst time

2.13

TIE-BREAKING

What do with ties?

- Round robin with time-slicing, allocating quantum to each process in turn
- Problem: biases towards CPU intensive jobs (Why?)
- Solution?
 - Per-process quantum based on usage?
 - Just ignore the problem?

2.14

STARVATION

Urban legend about IBM 7074 at MIT: when shut down in 1973, low-priority processes were found which had been submitted in 1967 and had not yet been run...

This is the biggest problem with static priority systems: a low priority process is not guaranteed to run – ever!

2.15

DYNAMIC PRIORITY SCHEDULING

Prevent the starvation problem: use same scheduling algorithm, but allow priorities to change over time

- Processes have a (static) base priority and a dynamic effective priority
 - If process starved for k seconds, increment effective priority
 - Once process runs, reset effective priority

2.16

EXAMPLE: COMPUTED PRIORITY

First used in Dijkstra's THE

- Timeslots: $\dots, t, t + 1, \dots$
- In each time slot t , measure the CPU usage of process j : u^j
- Priority for process j in slot $t + 1$:

$$p_{t+1}^j = f(u_t^j, p_t^j, u_{t-1}^j, p_{t-1}^j, \dots)$$

- E.g., $p_{t+1}^j = \frac{p_t^j}{2} + k u_t^j$
- Penalises CPU bound but supports IO bound

Once considered impractical but now such computation considered acceptable

2.17

SUMMARY

- First-Come First-Served
- Shortest Job First
- Shortest Response Time First
- Predicting Burst Length
- Round Robin
- Static vs Dynamic Priority

3

[06] VIRTUAL ADDRESSING

1.1

OUTLINE

- Memory Management
 - Concepts
 - Relocation, Allocation, Protection, Sharing, Logical vs Physical Organisation
- The Address Binding Problem
 - Relocation
 - Logical vs Physical Addresses
- Allocation
 - Scheduling
 - Fragmentation
 - Compaction

1.2

MEMORY MANAGEMENT

- **Memory Management**
 - **Concepts**
 - **Relocation, Allocation, Protection, Sharing, Logical vs Physical Organisation**
- The Address Binding Problem
- Allocation

2.1

CONCEPTS

In a multiprogramming system, have many processes in memory simultaneously

- Every process needs memory for:
 - Instructions ("code" or "text")
 - Static data (in program)
 - Dynamic data (heap and stack)
- In addition, operating system itself needs memory for instructions and data
 - Must share memory between OS and k processes

2.2

1. RELOCATION

- Memory typically shared among processes, so programmer cannot know address that process will occupy at runtime
- May want to swap processes into and out of memory to maximise CPU utilisation
- Silly to require a swapped-in process to always go to the same place in memory
- Processes incorporate addressing info (branches, pointers, etc.)
- OS must manage these references to make sure they are sane
- Thus need to translate logical to physical addresses

2. ALLOCATION

- This is similar to sharing below, but also related to relocation
- I.e. OS may need to choose addresses where things are placed to make linking or relocation easier

2.3

3. PROTECTION

- Protect one process from others
- May also want sophisticated RWX protection on small memory units
- A process should not modify its own code (...yuck...)
- Dynamically computed addresses (array subscripts) should be checked for sanity

4. SHARING

- Multiple processes executing same binary: keep only one copy
- Shipping data around between processes by passing shared data segment references
- Operating on same data means sharing locks with other processes

2.4

5. LOGICAL ORGANISATION

- Most physical memory systems are linear address spaces from 0 to max
- Doesn't correspond with modular structure of programs: want segments
- Modules can contain (modifiable) data, or just code
- Useful if OS can deal with modules: can be written, compiled independently
- Can give different modules diff protection, and can be shared thus easy for user to specify sharing model

6. PHYSICAL ORGANISATION

- Main memory: single linear address space, volatile, more expensive
- Secondary storage: cheap, non-volatile, can be arbitrarily structured
- One key OS function is to organise flow between main memory and the secondary store (cache?)
- Programmer may not know beforehand how much space will be available

2.5

THE ADDRESS BINDING PROBLEM

- Memory Management
- **The Address Binding Problem**
 - Relocation
 - Logical vs Physical Addresses
- Allocation

3.1

THE ADDRESS BINDING PROBLEM

Consider the following simple program:

```
int x, y;  
x = 5;  
y = x + 3;
```

We can imagine that this would result in some assembly code which looks something like:

```
str #5, [Rx] ; store 5 into x  
ldr R1, [Rx] ; load value of x from memory  
add R2, R1, #3 ; and add 3 to it  
str R2, [Ry] ; and store result in y
```

where the expression [addr] means *the contents of the memory at address addr*. Then the address binding problem is: what values do we give Rx and Ry?

Arises because we don't know where in memory our program will be loaded when we run it: e.g. if loaded at 0x1000, then x and y might be stored at 0x2000, 0x2004, but if loaded at 0x5000, then x and y might be at 0x6000, 0x6004

3.2

ADDRESS BINDING AND RELOCATION

Solution requires translation between *program* addresses and *real* addresses which can be done:

- **At compile time:**
 - Requires knowledge of absolute addresses, e.g. DOS .EXE files
- **At load time:**
 - Find position in memory after loading, update code with correct addresses
 - Must be done every time program is loaded
 - Ok for embedded systems / boot-loaders
- **At run-time:**
 - Get hardware to automatically translate between program and real addresses
 - No changes at all required to program itself
 - The most popular and flexible scheme, providing we have the requisite hardware (MMU)

Note that, nowadays, tend not to use only one of these for everything anyway -- will use a mixture.

3.3

LOGICAL VS PHYSICAL ADDRESSES

Mapping of logical to physical addresses is done at run-time by **Memory Management Unit (MMU)**

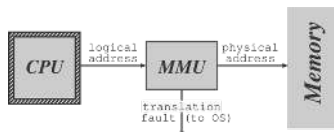

1. Relocation register holds the value of the base address owned by the process
2. Relocation register contents are added to each memory address before it is sent to memory
3. e.g. DOS on 80x86 – 4 relocation registers, logical address is a tuple (s, o)
 - NB. Process never sees physical address – simply manipulates logical addresses
4. OS has privilege to update relocation register

3.4

ALLOCATION

- Memory Management
- The Address Binding Problem
- **Allocation**
 - Scheduling
 - Fragmentation
 - Compaction

4.1

CONTIGUOUS ALLOCATION

How do we support multiple virtual processors in a single address space? Where do we put processes in memory?

- OS typically must be in low memory due to location of interrupt vectors
- Easiest way is to statically divide memory into multiple fixed size partitions:
 - Bottom partition contains OS, remainder each contain exactly one process
- When a process terminates its partition becomes available to new processes.
 - e.g. OS/360 MFT
- Need to protect OS and user processes from malicious programs:
 - Use base and limit registers in MMU
 - Update values when a new process is scheduled
 - NB. Solving both relocation and protection problems at the same time!

4.2

STATIC MULTIPROGRAMMING

- Partition memory when installing OS, and allocate pieces to different job queues
- Associate jobs to a job queue according to size
- Swap job back to disk when:
 - Blocked on IO (assuming IO is slower than the backing store)
 - Time sliced: larger the job, larger the time slice
- Run job from another queue while swapping jobs
 - e.g. IBM OS/360 MVT, ICL System 4
- Problems: fragmentation, cannot grow partitions

4.3

DYNAMIC PARTITIONING

More flexibility if allow partition sizes to be dynamically chosen (e.g. OS/360 MVT):

- OS keeps track of which areas of memory are available and which are occupied
 - e.g. use one or more linked lists:
 - For a new process, OS searches for a hole large enough to fit it:
 - **First fit:** stop searching list as soon as big enough hole is found
 - **Best fit:** search entire list to find "best" fitting hole
 - **Worst fit:** counterintuitively allocate largest hole (again, search entire list)
1. First and Best fit perform better statistically both in time and space utilisation – typically for N allocated blocks have another $0.5N$ in wasted space using first fit
 2. Which is better depends on pattern of process swapping
 3. Can use *buddy system* to make allocation faster
 4. When process terminates its memory returns onto the free list, coalescing holes where appropriate

4.4

SCHEDULING EXAMPLE

Consider a machine with total of 2560kB memory, and an OS requiring 400kB

- The following jobs are in the queue:

Process	Memory	Time
P_1	600kB	10
P_2	1000kB	5
P_3	300kB	20
P_4	700kB	8
P_5	500kB	15

4.5

EXTERNAL FRAGMENTATION

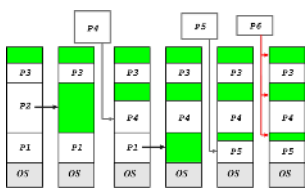

Dynamic partitioning algorithms suffer from external fragmentation: as processes are loaded they leave little fragments which may not be used. Can eventually block due to insufficient memory to swap in

External fragmentation exists when the total available memory is sufficient for a request, but is unusable as it is split into many holes

Can also have problems with tiny holes when keeping track of hole costs more memory than hole! Requires periodic compaction

4.6

COMPACTION



- Choosing optimal strategy quite tricky. Note that:
 - Require run-time relocation
 - Can be done more efficiently when process is moved into memory from a swap
 - Some machines used to have hardware support (e.g., CDC Cyber)
- Also get fragmentation in backing store, but in this case compaction not really viable

4.7

SUMMARY

- Memory Management
 - Concepts
 - Relocation, Allocation, Protection, Sharing, Logical vs Physical Organisation
- The Address Binding Problem
 - Relocation
 - Logical vs Physical Addresses
- Allocation
 - Scheduling
 - Fragmentation
 - Compaction

5

[07] PAGING

OUTLINE

- Paged Virtual Memory
 - Concepts
 - Pros and Cons
 - Page Tables
 - Translation Lookaside Buffer (TLB)
 - Protection & Sharing
- Virtual Memory
 - Demand Paging Details
 - Page Replacement
 - Page Replacement Algorithms
- Performance
 - Frame Allocation
 - Thrashing & Working Set
 - Pre-paging
 - Page Sizes

1.1

1.2

PAGED VIRTUAL MEMORY

- Paged Virtual Memory
 - Concepts
 - Pros and Cons
 - Page Tables
 - Translation Lookaside Buffer (TLB)
 - Protection & Sharing
- Virtual Memory
- Performance

2.1

PAGED VIRTUAL MEMORY

Another solution is to allow a process to exist in non-contiguous memory, i.e.,

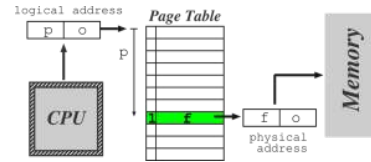

- Divide **physical** memory into **frames**, small fixed-size blocks
- Divide **logical** memory into **pages**, blocks of the same size (typically 4kB)
- Each CPU-generated address is a page number p with page offset o
- Page table contains associated frame number f
- Usually have $|p| \gg |f|$ so also record whether mapping valid

2.2

PAGING PROS AND CONS

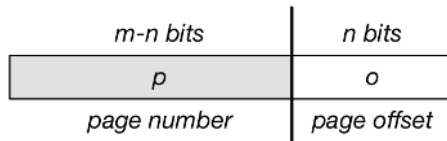

- Hardware support required – frequently defines the page size, typically a power of 2 (making address fiddling easy) ranging from 512B to 8192B (0.5kB – 8kB)
- Logical address space of 2^m and page size 2^n gives $p = m - n$ bits and $o = n$ bits
- Note that paging is itself a form of dynamic relocation: simply change page table to reflect movement of page in memory. This is similar to using a set of *base + limit* registers for each page in memory

2.3

PAGING PROS AND CONS

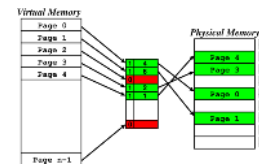

- Memory allocation becomes easier but OS must maintain a page table per process
 - No external fragmentation (in physical memory at least), but get internal fragmentation: a process may not use all of final page
 - Indicates use of small page sizes – but there's a significant per-page overhead: the **Page Table Entries** (PTEs) themselves, plus that disk IO is more efficient with larger pages
 - Typically 4kB (memory is cheaper)

2.4

PAGING PROS AND CONS

- Clear separation between user (process) and system (OS) view of memory usage
 - Process sees single logical address space; OS does the hard work
 - Process cannot address memory they don't own – cannot reference a page it doesn't have access to
 - OS can map system resources into user address space, e.g., IO buffer
 - OS must keep track of free memory; typically in **frame table**
- Adds overhead to context switching
 - Per process page table must be mapped into hardware on context switch
 - The page table itself may be large and extend into physical memory

2.5

PAGE TABLES

Page Tables (PTs) rely on hardware support:

- Simplest case: set of dedicated relocation registers
 - One register per page, OS loads registers on context switch
 - E.g., PDP-11 16 bit address, 8kB pages thus 8 PT registers
 - Each memory reference goes through these so they must be fast
- Ok for small PTs but what if we have many pages (typically $O(10^6)$)
 - Solution: Keep PT in memory, then just one MMU register needed, the **Page Table Base Register** (PTBR)
 - OS switches this when switching process
- Problem: PTs might still be very big
 - Keep a **PT Length Register** (PTLR) to indicate size of PT
 - Or use a more complex structure (see later)
- Problem: need to refer to memory twice for every "actual" memory reference
 - Solution: use a **Translation Lookaside Buffer** (TLB)

2.6

TLB OPERATION

When memory is referenced, present TLB with logical memory address

- If PTE is present, get an immediate result
- Otherwise make memory reference to PTs, and update the TLB
- Latter case is typically 10% slower than direct memory reference

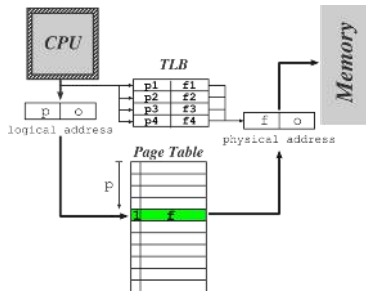

2.7

TLB ISSUES

As with any cache, what to do when it's full, how are entries shared?

- If full, discard entries typically Least Recently Used (LRU) policy
- Context switch requires TLB flush to prevent next process using wrong PTEs
- Mitigate cost through **process tags** (how?)

Performance is measured in terms of **hit ratio**, proportion of time a PTE is found in TLB. Example:

- Assume TLB search time of 20ns, memory access time of 100ns, hit ratio of 80%
 - Assume one memory reference required for lookup, what is the **effective memory access time**?
 - $0.8 \times 120 + 0.2 \times 220 = 140$ ns
- Now increase hit ratio to 98% – what is the new effective access time?
 - $0.98 \times 120 + 0.02 \times 220 = 122$ ns – just a 13% improvement
 - (Intel 80486 had 32 registers and claimed a 98% hit ratio)

2.8

MULTILEVEL PAGE TABLES

Most modern systems can support very large (2^{32} , 2^{64}) address spaces, leading to very large PTs which we don't really want to keep all of in main memory

Solution is to split the PT into several sub-parts, e.g., two, and then page the page table:

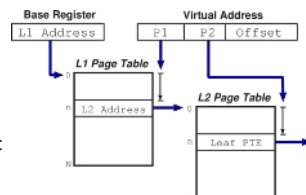

- Divide the page number into two parts
 - E.g., 20 bit **page number**, 12 bit **page offset**
- Then divide the page number into **outer** and **inner** parts of 10 bits each

2.9

EXAMPLE: VAX

A 32 bit architecture with 512 byte pages:

- Logical address space divided into 4 sections of 2^{30} bytes
- Top 2 address bits designate **section**
- Next 21 bits designate **page** within section
- Final 9 bits designate **page offset**
- For a VAX with 100 pages, one level PT would be 4MB; with sectioning, it's 1MB

For 64 bit architectures, two-level paging is not enough: add further levels.

- For 4kB pages need 2^{52} entries in PT using 1 level PT
- For 2 level PT with 32 bit outer PT, we'd still need 16GB for the outer PT

Even some 32 bit machines have > 2 levels: SPARC (32 bit) has 3 level paging scheme; 68030 has 4 level paging

2.10

EXAMPLE: X86

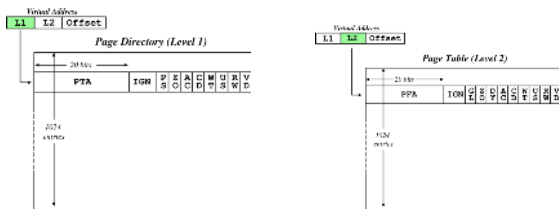

Page size is 4kB or 4MB. First lookup to the **page directory**, indexed using top 10 bits. The page directory address is stored in an internal processor register (`cr3`). The lookup results (usually) in the address of a page table. Next 10 bits index the **page table**, retrieving the **page frame address**. Finally, add in the low 12 bits as the **page offset**. Note that the page directory and page tables are exactly one page each themselves (not by accident)

2.11

PROTECTION ISSUES

Associate **protection bits** with each page, kept in page tables (and TLB), e.g. one bit for read, one for write, one for execute (RWX). Might also distinguish whether may only be accessed when executing in kernel mode, e.g.,



As the address goes through the page hardware, can check protection bits – though note this only gives *page granularity* protection, not byte granularity

Any attempt to violate protection causes hardware trap to operating system code to handle. The entry in the TLB will have a valid/invalid bit indicating whether the page is mapped into the process address space. If invalid, trap to the OS handler to map the page

Can do lots of interesting things here, particularly with regard to sharing, virtualization,...

2.12

SHARED PAGES

Another advantage of paged memory is code/data sharing, for example:

- Binaries: editor, compiler etc.
- Libraries: shared objects, DLLs

So how does this work?

- Implemented as two logical addresses which map to one physical address
- If code is re-entrant (i.e. stateless, non-self modifying) it can be easily shared between users
- Otherwise can use copy-on-write technique:
 - Mark page as read-only in all processes
 - If a process tries to write to page, will trap to OS fault handler
 - Can then allocate new frame, copy data, and create new page table mapping
- (May use this for lazy data sharing too)

Requires additional book-keeping in OS, but worth it, e.g., many hundreds of MB shared code on this laptop. (Though nowadays, see unikernels!)

2.13

VIRTUAL MEMORY

- Paged Virtual Memory
- **Virtual Memory**
 - Demand Paging Details
 - Page Replacement
 - Page Replacement Algorithms
- Performance

3.1

VIRTUAL MEMORY

Virtual addressing allows us to introduce the idea of **virtual memory**

- Already have valid or invalid page translations; introduce "non-resident" designation and put such pages on a non-volatile backing store
- Processes access non-resident memory just as if it were "the real thing"

Virtual Memory (VM) has several benefits:

- **Portability:** programs work regardless of how much actual memory present; programs can be larger than physical memory
- **Convenience:** programmer can use e.g. large sparse data structures with impunity; less of the program needs to be in memory at once, thus potentially more efficient multi-programming, less IO loading/swapping program into memory
- **Efficiency:** no need to waste (real) memory on code or data which isn't used (e.g., error handling)

3.2

VM IMPLEMENTATION

Typically implemented via demand paging:

- Programs (executables) reside on disk
- To execute a process we load pages in on demand; i.e. as and when they are referenced
- Also get demand segmentation, but rare (eg., Burroughs, OS/2) as it's more difficult (segment replacement is much harder due to segments having variable size)

3.3

DEMAND PAGING DETAILS

When loading a new process for execution:

- Create its address space (page tables, etc)
- Mark PTEs as either invalid or non-resident
- Add PCB to scheduler

Then whenever we receive a page fault, check PTE:

- If due to invalid reference, kill process
- Otherwise due to non-resident page, so "page in" the desired page:
 - Find a free frame in memory
 - Initiate disk IO to read in the desired page
 - When IO is finished modify the PTE for this page to show that it is now valid
 - Restart the process at the faulting instruction

3.4

DEMAND PAGING: ISSUES

Above process makes the fault invisible to the process, but:

- Requires care to save process state correctly on fault
- Can be particularly awkward on a CPU with pipelined decode as we need to wind back (e.g., MIPS, Alpha)
- Even worse on on CISC CPU where single instruction can move lots of data, possibly across pages – we can't restart the instruction so rely on help from microcode (e.g., to test address before writing). Can possibly use temporary registers to store moved data
- Similar difficulties from auto-increment/auto-decrement instructions, e.g., ARM
- Can even have instructions and data spanning pages, so multiple faults per instruction; though **locality of reference** tends to make this infrequent

Scheme described above is pure demand paging: don't bring in pages until needed so get lots of page faults and IO when process begins; hence many real systems explicitly load some core parts of the process first

3.5

PAGE REPLACEMENT

To page in from disk, we need a free frame of physical memory to hold the data we're reading in – but in reality, the size of physical memory is limited so either:

- Discard unused pages if total demand for pages exceeds physical memory size
- Or swap out an entire process to free some frames

Modified algorithm: on a page fault we:

1. Locate the desired replacement page on disk
2. Select a free frame for the incoming page:
 1. If there is a free frame use it, otherwise select a victim page to free
 2. Then write the victim page back to disk
 3. Finally mark it as invalid in its process page tables
3. Read desired page into the now free frame
4. Restart the faulting process

...thus, having no frames free effectively doubles the page fault service time

3.6

PAGE REPLACEMENT

Can reduce overhead by adding a "dirty" bit to PTEs

- Allows us to omit step (2.2) above: only write out page if it was modified
- Similarly can omit step (2.2) if page is marked read-only, e.g., contains code

How do we choose our victim page?

- A key factor in an efficient VM system: evicting a page that we'll need in a few instructions time can get us into a really bad condition
- We want to ensure that we get few page faults overall, and that any we do get are relatively quick to satisfy

We will now look at a few **page replacement algorithms**:

- All aim to minimise page fault rate
- Candidate algorithms are evaluated by (trace driven) simulation using reference strings

3.7

PAGE REPLACEMENT ALGORITHMS

FIRST-IN FIRST-OUT (FIFO)

Keep a queue of pages, discard from head. Performance is hard to predict as we've no idea whether replaced page will be used again or not: eviction is independent of page use frequency. In general this is very simple but pretty bad:

- Can actually end up discarding a page currently in use, causing an immediate fault and next in queue to be replaced – really slows system down
- Possible to have more faults with increasing number of frames (**Belady's anomaly**)

OPTIMAL ALGORITHM (OPT)

Replace the page which will not be used again for longest period of time. Can only be done with an oracle or in hindsight, but serves as a good baseline for other algorithms

3.8

LEAST RECENTLY USED (LRU)

Replace the page which has not been used for the longest amount of time. Equivalent to OPT with time running backwards. Assumes that the past is a good predictor of the future. Can still end up replacing pages that are about to be used

Generally considered quite a good replacement algorithm, though may require substantial hardware assistance

But! How do we determine the LRU ordering?

3.9

IMPLEMENTING LRU: COUNTERS

- Give each PTE a time-of-use field and give the CPU a logical clock (counter)
- Whenever a page is referenced, its PTE is updated to clock value
- Replace page with smallest time value

Problems:

- Requires a search to find minimum counter value
- Adds a write to memory (PTE) on every memory reference
- Must handle clock overflow

Impractical on a standard processor

3.10

IMPLEMENTING LRU: PAGE STACK

- Maintain a stack of pages (doubly linked list) with most-recently used (MRU) page on top
- Discard from bottom of stack

Problem:

- Requires changing (up to) 6 pointers per [new] reference
- This is very slow without extensive hardware support

Also impractical on a standard processor

3.11

APPROXIMATING LRU

Many systems have a reference bit in the PTE, initially zeroed by OS, and then set by hardware whenever the page is touched. After time has passed, consider those pages with the bit set to be **active** and implement **Not Recently Used** (NRU) replacement:

- Periodically (e.g. 20ms) clear all reference bits
- When choosing a victim to evict, prefer pages with clear reference bits
- If also have a **modified** or **dirty bit** in the PTE, can use that too

Referenced?	Dirty?	Comment
no	no	best type of page to replace
no	yes	next best (requires writeback)
yes	no	probably code in use
yes	yes	bad choice for replacement

3.12

IMPROVING THE APPROXIMATION

Instead of just a single bit, the OS:

- Maintains an 8-bit value per page, initialised to zero
- Periodically (e.g. 20ms) shifts reference bit onto high order bit of the byte, and clear reference bit

Then select lowest value page (or one of) to replace

- Keeps the history for the last 8 clock sweeps
- Interpreting bytes as `uint8_t`, then LRU page is `min(additional_bits)`
- May not be unique, but gives a candidate set

3.13

FURTHER IMPROVMENT: SECOND-CHANCE FIFO

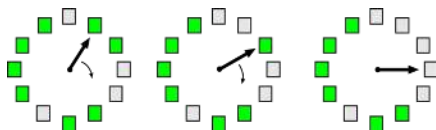

- Store pages in queue as per FIFO
- Before discarding head, check reference bit
- If reference bit is 0, discard else reset reference bit, and give page a second chance (add it to tail of queue)

Guaranteed to terminate after at most one cycle, with the worst case having the second chance devolve into a FIFO if all pages are referenced. A page given a second chance is the last to be replaced

3.14

IMPLEMENTING SECOND-CHANCE FIFO

Often implemented with a circular queue and a current pointer; in this case usually called **clock**

If no hardware is provided, reference bit can emulate:

- To clear "reference bit", mark page no access
- If referenced then trap, update PTE, and resume
- To check if referenced, check permissions
- Can use similar scheme to emulate modified bit

3.15

OTHER REPLACEMENT SCHEMES

Counting Algorithms: keep a count of the number of references to each page

- **Least Frequently Used (LFU):** replace page with smallest count
 - Takes no time information into account
 - Page can stick in memory from initialisation
 - Need to periodically decrement counts
- **Most Frequently Used (MFU):** replace highest count page
 - Low count indicates recently brought in

3.16

PAGE BUFFERING ALGORITHMS

- Keep a minimum number of victims in a free pool
- New page read in before writing out victim, allowing quicker restart of process
- Alternative: if disk idle, write modified pages out and reset dirty bit
 - Improves chance of replacing without having to write dirty page

(Pseudo) MRU: Consider accessing e.g. large array.

- The page to replace is one application has just finished with, i.e. most recently used
- Track page faults and look for sequences
- Discard the k th in victim sequence

Application-specific: stop trying to second-guess what's going on and provide hook for application to suggest replacement, but must be careful with denial of service

3.17

PERFORMANCE

- Paged Virtual Memory
- Virtual Memory
- **Performance**
 - **Frame Allocation**
 - **Thrashing & Working Set**
 - **Pre-paging**
 - **Page Sizes**

4.1

PERFORMANCE COMPARISON

This plot shows page-fault rate against number of physical frames for a pseudo-local reference string (note offset x origin). We want to minimise area under curve. FIFO could exhibit *Belady's Anomaly* (but doesn't here). Can see that getting frame allocation right has major impact – much more than which algorithm you use!

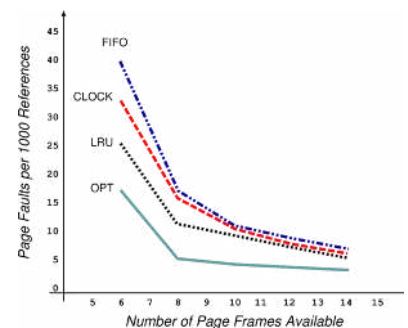

4.2

FRAME ALLOCATION

A certain fraction of physical memory is reserved per-process and for core OS code and data. Need an allocation policy to determine how to distribute the remaining frames. Objectives:

- Fairness (or proportional fairness)?
 - E.g. divide m frames between n processes as m/n , remainder in free pool
 - E.g. divide frames in proportion to size of process (i.e. number of pages used)
- Minimize system-wide page-fault rate?
 - E.g. allocate all memory to few processes
- Maximize level of multiprogramming?
 - E.g. allocate min memory to many processes

Could also allocate taking process priorities into account, since high-priority processes are supposed to run more readily. Could even care which frames we give to which process ("page colouring")

4.3

FRAME ALLOCATION: GLOBAL SCHEMES

Most page replacement schemes are global: all pages considered for replacement

- Allocation policy implicitly enforced during page-in
- Allocation succeeds iff policy agrees
- *Free frames* often in use so steal them!

For example, on a system with 64 frames and 5 processes:

- If using fair share, each processes will have 12 frames, with four left over (maybe)
- When a process dies, when the next faults it will succeed in allocating a frame
- Eventually all will be allocated
- If a new process arrives, need to steal some pages back from the existing allocations

4.4

FRAME ALLOCATION: COMPARISON TO LOCAL

Also get **local page replacement schemes**: victim always chosen from within process

In global schemes the process cannot control its own page fault rate, so performance may depend entirely on what other processes page in/out

In local schemes, performance depends only on process behaviour, but this can hinder progress by not making available less/unused pages of memory

Global are optimal for throughput and are the most common

4.5

THE RISK OF THRASHING

More processes entering the system causes the **frames-per-process** allocated to reduce. Eventually we hit a wall: processes end up stealing frames from each other, but then need them back so fault. Ultimately the number of runnable processes plunges

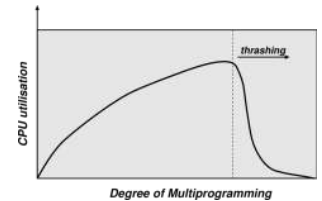

A process can *technically* run with minimum-free frames available but will have a very high page fault rate. If we're very unlucky, OS monitors CPU utilisation and increases level of multiprogramming if utilisation is too low: machine dies

Avoid thrashing by giving processes as many frames as they "need" and, if we can't, we must reduce the MPL – a better page-replacement algorithm will not help

4.6

LOCALITY OF REFERENCE

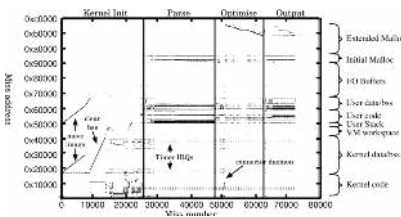

In a short time interval, the locations referenced by a process tend to be grouped into a few regions in its address space:

- Procedure being executed
- Sub-procedures
- Data access
- Stack variables

4.7

AVOIDING THRASHING

We can use the locality of reference principle to help determine how many frames a process needs:

- Define the **Working Set (WS)** (Denning, 1967)

Set of pages that a process needs in store at "the same time" to make any progress

- Varies between processes and during execution
- Assume process moves through phases
- In each phase, get (spatial) locality of reference
- From time to time get phase shift

4.8

CALCULATING WORKING SET

Then OS can try to prevent thrashing by maintaining sufficient pages for current phase:

- Sample page reference bits every, e.g., 10ms
- Define window size Δ of most recent page references
- If a page is "in use", say it's in the working set
- Gives an approximation to locality of program
- Given the size of the working set for each process WSS_i , sum working set sizes to get total demand D
- If $D > m$ we are in danger of thrashing – suspend a process

This optimises CPU util but has the need to compute WSS_i (moving window across stream). Can approximate with periodic timer and some page reference script. After some number of intervals (i.e., of bits of state) consider pages with count < 0 to be in WS. In general, a working set can be used as a scheme to determine allocation for each process

4.9

PRE-PAGING

- Pure demand paging causes a large number of PF when process starts
- Can remember the WS for a process and pre-page the required frames when process is resumed (e.g. after suspension)
- When process is started can pre-page by adding its frames to free list
- Increases IO cost: How do we select a page size (given no hardware constraints)?

4.10

PAGE SIZES

- Trade-off the size of the PT and the degree of fragmentation as a result
- Typical values are 512B to 16kB – but should we reduce the number of faults, or ensure that the window is covered efficiently?
- Larger page size means fewer page faults
 - Historical trend towards larger page sizes
 - Eg., 386: 4kB, 68030: 256B to 32kB

So, 28ms for a 1kB page, 56ms for two 512B pages – but the smaller page size allows us to watch locality more accurately. Page faults remain costly because CPU and memory much much faster than disk

4.11

SUMMARY

- Paged Virtual Memory
 - Concepts
 - Pros and Cons
 - Page Tables
 - Translation Lookaside Buffer (TLB)
 - Protection & Sharing
- Virtual Memory
 - Demand Paging Details
 - Page Replacement
 - Page Replacement Algorithms
- Performance
 - Frame Allocation
 - Thrashing & Working Set
 - Pre-paging
 - Page Sizes

5

[08] SEGMENTATION

1.1

OUTLINE

- Segmentation
 - An Alternative to Paging
- Implementing Segments
 - Segment Table
 - Lookup Algorithm
- Protection and Sharing
 - Sharing Subtleties
 - External Fragmentation
- Segmentation vs Paging
 - Comparison
 - Combination
- Summary
- Extras
 - Dynamic Linking & Loading

1.2

SEGMENTATION

- Segmentation
 - An Alternative to Paging
- Implementing Segments
- Protection and Sharing
- Segmentation vs Paging
- Summary
- Extras

2.1

AN ALTERNATIVE TO PAGING

View memory as a set of segments of no particular size, with no particular ordering

This corresponds to typical modular approaches taken to program development

The length of a segment depends on the complexity of the function (e.g., `sqrt`)

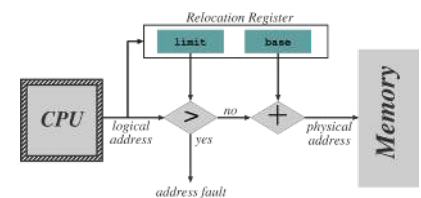

2.2

WHAT IS A SEGMENT?

Segmentation supports the user-view of memory that the logical address space becomes a collection of (typically disjoint) segments

Segments have a **name** (or a **number**) and a **length**. Addresses specify **segment**, and **offset** within segment

To access memory, user program specifies *segment + offset*, and the compiler (or, as in MULTICS, the OS) translates

This contrasts with paging where the user is unaware of memory structure – everything is managed invisibly by the OS

2.3

IMPLEMENTING SEGMENTS

- Segmentation
- **Implementing Segments**
 - Segment Table
 - Lookup Algorithm
- Protection and Sharing
- Segmentation vs Paging
- Summary
- Extras

3.1

IMPLEMENTING SEGMENTS

Logical addresses are pairs, (segment, offset)

For example, the compiler might construct distinct segments for global variables, procedure call stack, code for each procedure/function, local variables for each procedure/function

Finally the loader takes each segment and maps it to a physical segment number

3.2

IMPLEMENTING SEGMENTS

Segment	Access	Base	Size	Others!
---------	--------	------	------	---------

Maintain a **Segment Table** for each process:

- If there are too many segments then the table is kept in memory, pointed to by **ST Base Register** (STBR)
- Also have an **ST Length Register** (STLR) since the number of segments used by different programs will diverge widely
- ST is part of the process context and hence is changed on each process switch
- ST logically accessed on each memory reference, so speed is critical

3.3

IMPLEMENTING SEGMENTS: ALGORITHM

1. Program presents address (s, d) .
2. If $s \geq \text{STLR}$ then give up
3. Obtain table entry at reference $s + \text{STBR}$, a tuple of form (b_s, l_s)
4. If $0 \leq d < l_s$ then this is a valid address at location (b_s, d) , else fault

- The two operations b_s, d (concatenation) and $0 \leq d < l_s$ can be done simultaneously to save time
- Still requires 2 memory references per lookup though, so care needed
- E.g., Use a set of associative registers to hold most recently used ST entries
- Similar performance gains to the TLB description earlier

3.4

PROTECTION AND SHARING

- Segmentation
- Implementing Segments
- **Protection and Sharing**
 - **Sharing Subtleties**
 - **External Fragmentation**
- Segmentation vs Paging
- Summary
- Extras

4.1

PROTECTION

Segmentation's big advantage is to provide protection between components

That protection is provided *per segment*; i.e. it corresponds to the logical view

Protection bits associated with each ST entry checked in usual way, e.g., instruction segments should not be self-modifying, so are protected against writes

Could go further – e.g., place every array in its own segment so that array limits can be checked by the hardware

4.2

SHARING

Segmentation also facilitates sharing of code/data:

- Each process has its own STBR/STLR
- Sharing is enabled when two processes have entries for the same physical locations
- Sharing occurs at segment level, with each segment having own protection bits
 - For data segments can use copy-on-write as per paged case
- Can share only parts of programs, e.g., C library but there are subtleties

4.3

SHARING: SUBTLETIES

- For example, jumps within shared code
 - Jump specified as a condition + transfer address, i.e., (segment, offset)
 - Segment is (of course) this one
 - Thus all programs sharing this segment must use the same number to refer to it, else confusion will result
 - As the number of users sharing a segment grows, so does difficulty of finding a common shared segment number
 - Thus, specify branches as PC-relative or relative to a register containing the current segment number
 - (Read only segments containing no pointers may be shared with different seg numbers)

4.4

SHARING SEGMENTS

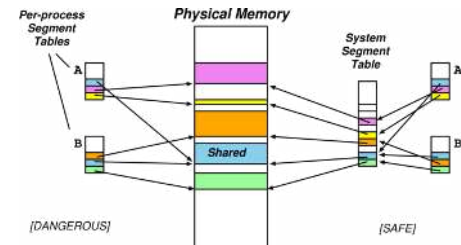

- Wasteful (and dangerous) to store common information on shared segment in each process segment table
- Assign each segment a unique **System Segment Number (SSN)**
- Process Segment Table** simply maps from a **Process Segment Number (PSN)** to SSN

4.5

EXTERNAL FRAGMENTATION RETURNS

Long term scheduler must find spots in memory for all segments of a program. Problem is that segments are variable size – thus, we must handle **fragmentation**

- Usually resolved with best/first fit algorithm
- External frag may cause process to have to wait for sufficient space
- Compaction can be used in cases where a process would be delayed

Tradeoff between compaction/delay depends on average segment size

- Each process has just one segment reduces to variable sized partitions
- Each byte has its own segment separately relocated quadruples memory use!
- Fixed size small segments is equivalent to paging!
- Generally, with small average segment sizes, external fragmentation is small – more likely to make things fit with lots of small ones (box packing)

4.6

SEGMENTATION VS PAGING

- Segmentation
- Implementing Segments
- Protection and Sharing
- Segmentation vs Paging**
 - Comparison
 - Combination
- Summary
- Extras

5.1

SEGMENTATION VERSUS PAGING

- Protection, Sharing, Demand etc are all per segment or page, depending on scheme
- For **protection and sharing**, easier to have it per logical entity, i.e., per segment
- For **allocation and demand access** (and, in fact, certain types of sharing such as COW), we prefer paging because:
 - Allocation is easier
 - Cost of sharing/demand loading is minimised

	logical view	allocation
segmentation	good	bad
paging	bad	good

5.2

COMBINING SEGMENTATION AND PAGING

- Paged segments**, used in Multics, OS/2
 - Divide each segment s_i into $k = \lceil l_i/2^n \rceil$ pages, where l_i is the limit (length) of the segment
 - Provision one page table per segment
 - Unfortunately: high hardware cost and complexity; not very portable
- Software segments**, used in most modern OSs
 - Consider pages $[m, \dots, m + l]$ to be a segment
 - OS must ensure protection and sharing kept consistent over region
 - Unfortunately, leads to a loss of granularity
 - However, it is relatively simple and portable

Arguably, main reason hardware segments lost is portability: you can do software segments with just paging hardware, but cannot (easily) do software paging with segmentation hardware

5.3

SUMMARY

- Segmentation
- Implementing Segments
- Protection and Sharing
- Segmentation vs Paging
- **Summary**
- Extras

6.1

SUMMARY: VIRTUAL ADDRESSING

- Direct access to physical memory is not great as have to handle:
 - Contiguous allocation: need a large lump, end up with external fragmentation
 - Address binding: handling absolute addressing
 - Portability: how much memory does a "standard" machine have?
- Avoid problems by separating concepts of virtual (logical) and physical addresses (Atlas computer, 1962)
- Needham's comment

"every problem in computer science can be solved by an extra level of indirection"

6.2

SUMMARY: VIRTUAL TO PHYSICAL ADDRESS MAPPING

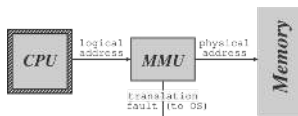

- Runtime mapping of logical to physical addresses handled by the MMU. Make mapping per-process, then:
 - Allocation problem split:
 - Virtual address allocation easy
 - Allocate physical memory 'behind the scenes'
 - Address binding solved:
 - Bind to logical addresses at compile-time
 - Bind to real addresses at load time/run time
- Modern operating systems use paging hardware and fake out segments in software

6.3

SUMMARY: IMPLEMENTATION CONSIDERATIONS

- **Hardware support**
 - Simple base register enough for partitioning
 - Segmentation and paging need large tables
- **Performance**
 - Complex algorithms need more lookups per reference plus hardware support
 - Simple schemes preferred eg., simple addition to base
- **Fragmentation:** internal/external from fixed/variable size allocation units
- **Relocation:** solves external fragmentation, at high cost
 - Logical addresses must be computed dynamically, doesn't work with load time relocation
- **Swapping:** can be added to any algorithm, allowing more processes to access main memory
- **Sharing:** increases multiprogramming but requires paging or segmentation
- **Protection:** always useful, necessary to share code/data, needs a couple of bits

6.4

EXTRAS

- Segmentation
- Implementing Segments
- Protection and Sharing
- Segmentation vs Paging
- Summary
- **Extras**
 - **Dynamic Linking & Loading**

7.1

DYNAMIC LINKING

Relatively new appearance in OS (early 80's). Uses *shared objects/libraries* (Unix), or *dynamically linked libraries* (DLLs; Windows). Enables a compiled binary to invoke, at runtime, routines which are dynamically linked:

- If a routine is invoked which is part of the dynamically linked code, this will be implemented as a call into a set of stubs
- Stubs check if routine has been loaded
- If not, linker loads routine (if necessary) and replaces stub code by routing
- If sharing a library, the address binding problem must also be solved, requiring OS support: in the system, only the OS knows which libraries are being shared among which processes
- Shared libs must be stateless or concurrency safe or copy on write

Results in smaller binaries (on-disk and in-memory) and increase flexibility (fix a bug without relinking all binaries)

7.2

DYNAMIC LOADING

- At runtime a routine is loaded when first invoked
- The dynamic loader performs relocation on the fly
- It is the responsibility of the user to implement loading
- OS may provide library support to assist user

7.3

SUMMARY

- Segmentation
 - An Alternative to Paging
- Implementing Segments
 - Segment Table
 - Lookup Algorithm
- Protection and Sharing
 - Sharing Subtleties
 - External Fragmentation
- Segmentation vs Paging
 - Comparison
 - Combination
- Summary
- Extras
 - Dynamic Linking & Loading

8

[09] IO SUBSYSTEM

1.1

OUTLINE

- Input/Output (IO)
 - Hardware
 - Device Classes
 - OS Interfaces
- Performing IO
 - Polled Mode
 - Interrupt Driven
 - Blocking vs Non-blocking
- Handling IO
 - Buffering & Strategies
 - Other Issues
 - Kernel Data Structures
 - Performance

1.2

INPUT/OUTPUT

- **Input/Output (IO)**
 - Hardware
 - Device Classes
 - OS Interfaces
- Performing IO
- Handling IO

2.1

IO HARDWARE

Very wide range of **devices** that interact with the computer via **input/output (IO)**:

- Human readable: graphical displays, keyboard, mouse, printers
- Machine readable: disks, tapes, CD, sensors
- Communications: modems, network interfaces, radios

All differ significantly from one another with regard to:

- **Data rate**: orders of magnitude different between keyboard and network
- **Control complexity**: printers much simpler than disks
- **Transfer unit and direction**: blocks vs characters vs frame stores
- **Data representation**
- **Error handling**

2.2

IO SUBSYSTEM

Results in IO subsystem generally being the "messiest" part of the OS

- So much variety of devices
- So many applications
- So many dimensions of variation:
 - Character-stream or block
 - Sequential or random-access
 - Synchronous or asynchronous
 - Shareable or dedicated
 - Speed of operation
 - Read-write, read-only, or write-only

Thus, completely homogenising device API is not possible so OS generally splits devices into four classes

2.3

DEVICE CLASSES

Block devices (e.g. disk drives, CD)

- Commands include `read`, `write`, `seek`
- Can have **raw** access or via (e.g.) filesystem ("cooked") or memory-mapped

Character devices (e.g. keyboards, mice, serial):

- Commands include `get`, `put`
- Layer libraries on top for line editing, etc

Network Devices

- Vary enough from block and character devices to get their own interface
- Unix and Windows NT use the **Berkeley Socket** interface

Miscellaneous

- Current time, elapsed time, timers, clocks
- (Unix) `ioctl` covers other odd aspects of IO

2.4

OS INTERFACES

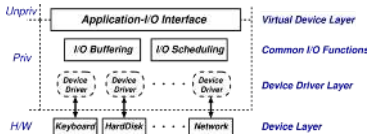

Programs access **virtual devices**:
Terminal streams not terminals,
windows not frame buffer, event
streams not raw mouse, files not disk
blocks, print spooler not parallel port,
transport protocols not raw Ethernet
frames

OS handles the processor-device interface: IO instructions vs memory mapped devices; IO hardware type (e.g. 10s of serial chips); Polled vs interrupt driven; CPU interrupt mechanism

Virtual devices then implemented:

- In kernel, e.g. files, terminal devices
- In daemons, e.g. spooler, windowing
- In libraries, e.g. terminal screen control, sockets

2.5

PERFORMING IO

- Input/Output (IO)
- **Performing IO**
 - **Polled Mode**
 - **Interrupt Driven**
 - **Blocking vs Non-blocking**
- Handling IO

3.1

POLLED MODE

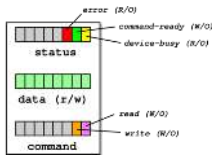

Consider a simple device with three registers:
status, data and command. Host can read
and write these via bus. Then polled mode
operation works as follows:

- **H** repeatedly reads `device-busy` until clear
- **H** sets e.g. `write` bit in command register, and puts data into data register
- **H** sets `command-ready` bit in status register
- **D** sees `command-ready` and sets `device-busy`
- **D** performs write operation
- **D** clears `command-ready` & then clears `device-busy`

What's the problem here?

3.2

INTERRUPT DRIVEN

Rather than polling, processors provide an interrupt mechanism to handle mismatch between CPU and device speeds:

- At end of each instruction, processor checks interrupt line(s) for pending interrupt
 - Need not be precise (that is, occur at definite point in instruction stream)
- If line is asserted then processor:
 - Saves program counter & processor status
 - Changes processor mode
 - Jumps to a well-known address (or contents of a well-known address)
- Once interrupt-handling routine finishes, can use e.g. `rti` instruction to resume
- More complex processors may provide:
 - Multiple priority levels of interrupt
 - **Hardware vectoring** of interrupts
 - Mode dependent registers

3.3

HANDLING INTERRUPTS

Split the implementation into two parts:

- At the bottom, the **interrupt handler**
- At the top, N **interrupt service routines** (ISR; per-device)

Processor-dependent interrupt handler may:

- Save more registers and establish a language environment
- Demultiplex interrupt in software and invoke relevant ISR

Device- (not processor-) dependent interrupt service routine will:

- For programmed IO device: transfer data and clear interrupt
- For DMA devices: acknowledge transfer; request any more pending; signal any waiting processes; and finally enter the scheduler or return

Question: *Who is scheduling whom?*

- Consider, e.g., network livelock

3.4

BLOCKING VS NON-BLOCKING

From programmer's point of view, IO system calls exhibit one of three kinds of behaviour:

- **Blocking**: process suspended until IO completed
 - Easy to use and understand.
 - Insufficient for some needs.
- **Nonblocking**: IO call returns as much as available
 - Returns almost immediately with count of bytes read or written (possibly 0)
 - Can be used by e.g. user interface code
 - Essentially application-level "polled IO"
- **Asynchronous**: process runs while IO executes
 - IO subsystem explicitly signals process when its IO request has completed
 - Most flexible (and potentially efficient)
 - Also most complex to use

3.5

HANDLING IO

- Input/Output (IO)
- Performing IO
- Handling IO
 - Buffering & Strategies
 - Other Issues
 - Kernel Data Structures
 - Performance

4.1

IO BUFFERING

To cope with various **impedance mismatches** between devices (speed, transfer size), OS may **buffer** data in memory. Various buffering strategies:

- **Single buffering:** OS assigns a system buffer to the user request
- **Double buffering:** process consumes from one buffer while system fills the next
- **Circular buffering:** most useful for bursty IO

Buffering is useful for smoothing peaks and troughs of data rate, but can't help if on average:

- Process demand > data rate (process will spend time waiting), or
- Data rate > capability of the system (buffers will fill and data will spill)
- Downside: can introduce **jitter** which is bad for real-time or multimedia

Details often dictated by device type: character devices often by line; network devices particularly bursty in time and space; block devices make lots of fixed size transfers and often the major user of IO buffer memory

4.2

SINGLE BUFFERING

OS assigns a single buffer to the user request:

- OS performs transfer, moving buffer to userspace when complete (remap or copy)
- Request new buffer for more IO, then reschedule application to consume (**readahead** or **anticipated input**)
- OS must track buffers
- Also affects swap logic: if IO is to same disk as swap device, doesn't make sense to swap process out as it will be behind the now queued IO request!

A crude performance comparison between no buffering and single buffering:

- Let t be time to input block and c be computation time between blocks
- Without buffering, execution time between blocks is $t + c$
- With single buffering, time is $\max(c, t) + m$ where m is the time to move data from buffer to user memory
- For a terminal: is the buffer a line or a char? depends on user response required

4.3

DOUBLE BUFFERING

- Often used in video rendering
- Rough performance comparison: takes $\max(c, t)$ thus
 - possible to keep device at full speed if $c < t$
 - while if $c > t$, process will not have to wait for IO
- Prevents need to suspend user process between IO operations
- ...also explains why two buffers is better than one buffer, twice as big
- Need to manage buffers and processes to ensure process doesn't start consuming from an only partially filled buffer

CIRCULAR BUFFERING

- Allows consumption from the buffer at a fixed rate, potentially lower than the **burst rate** of arriving data
- Often use circular linked list \sim FIFO buffer with queue length

4.4

OTHER ISSUES

- **Caching:** fast memory holding copy of data for both reads and writes; critical to IO performance
- **Scheduling:** order IO requests in per-device queues; some OSs may even attempt to be fair
- **Spooling:** queue output for a device, useful if device is "single user" (e.g., printer), i.e. can serve only one request at a time
- **Device reservation:** system calls for acquiring or releasing exclusive access to a device (care required)
- **Error handling:** generally get some form of error number or code when request fails, logged into system error log (e.g., transient write failed, disk full, device unavailable, ...)

4.5

KERNEL DATA STRUCTURES

To manage all this, the OS kernel must maintain state for IO components:

- Open file tables
- Network connections
- Character device states

Results in many complex and performance critical data structures to track buffers, memory allocation, "dirty" blocks

Consider reading a file from disk for a process:

- Determine device holding file
- Translate name to device representation
- Physically read data from disk into buffer
- Make data available to requesting process
- Return control to process

4.6

PERFORMANCE

IO a major factor in system performance

- Demands CPU to execute device driver, kernel IO code, etc.
- Context switches due to interrupts
- Data copying

Improving performance:

- Reduce number of context switches
- Reduce data copying
- Reduce number of interrupts by using large transfers, smart controllers, polling
- Use DMA where possible
- Balance CPU, memory, bus and IO performance for highest throughput.

Improving IO performance remains a significant challenge...

4.7

SUMMARY

- Input/Output (IO)
 - Hardware
 - Device Classes
 - OS Interfaces
- Performing IO
 - Polled Mode
 - Interrupt Driven
 - Blocking vs Non-blocking
- Handling IO
 - Buffering & Strategies
 - Other Issues
 - Kernel Data Structures
 - Performance

5

[10] STORAGE

OUTLINE

- File Concepts
 - Filesystems
 - Naming Files
 - File Metadata
- Directories
 - Name Space Requirements
 - Structure
 - Implementation
- Files
 - Operations
 - Implementation
 - Access Control, Existence Control, Concurrency Control

1.1

1.2

FILE CONCEPTS

- File Concepts
 - Filesystems
 - Naming Files
 - File Metadata
- Directories
- Files

2.1

FILESYSTEM

We will look only at very simple filesystems here, having two main components:

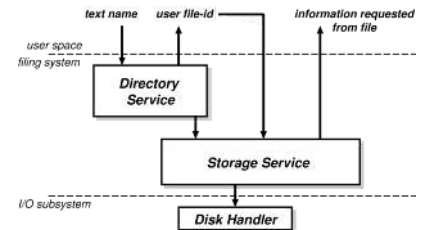

1. **Directory Service**, mapping names to file identifiers, and handling access and existence control
2. **Storage Service**, providing mechanism to store data on disk, and including means to implement directory service

2.2

WHAT IS A FILE?

The basic abstraction for non-volatile storage:

- User abstraction – compare/contrast with segments for memory
- Many different types:
 - Data: numeric, character, binary
 - Program: source, object, executable
 - "Documents"
- Typically comprises a single contiguous logical address space

Can have varied internal structure:

- None: a simple sequence of words or bytes
- Simple record structures: lines, fixed length, variable length
- Complex internal structure: formatted document, relocatable object file

2.3

WHAT IS A FILE?

OS split between *text* and *binary* is quite common where text files are treated as

- A sequence of lines each terminated by a special character, and
- With an explicit EOF character (often)

Can map everything to a byte sequence by inserting appropriate control characters, and interpretation in code. Question is, who decides:

- OS: may be easier for programmer but will lack flexibility
- Programmer: has to do more work but can evolve and develop format

2.4

NAMING FILES

Files usually have at least two kinds of "name":

- **System file identifier (SFID)**: (typically) a unique integer value associated with a given file, used within the filesystem itself
- **Human name**, e.g. `hello.java`: what users like to use
- May have a third, **User File Identifier (UFID)** used to identify open files in applications

Mapping from human name to SFID is held in a directory, e.g.,

Name	SFID
hello.java	12353
Makefile	23812
README	9742

Note that directories are *also* non-volatile so they must be stored on disk along with files – which explains why the storage system sits "below" the directory service

2.5

FILE METADATA

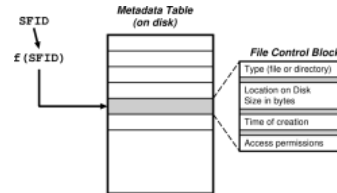

NB. Having resolved the name to an SFID, the actual mapping from SFID to **File Control Block (FCB)** is OS and filesystem specific

In addition to their contents and their name(s), files typically have a number of other attributes or **metadata**, e.g.,

- **Location**: pointer to file location on device
- **Size**: current file size
- **Type**: needed if system supports different types
- **Protection**: controls who can read, write, etc.
- **Time, date, and user identification**: data for protection, security and usage monitoring

2.6

DIRECTORIES

- File Concepts
- **Directories**
 - Name Space Requirements
 - Structure
 - Implementation
- Files

3.1

REQUIREMENTS

A **directory** provides the means to translate a (user) name to the location of the file on-disk. What are the requirements?

- **Efficiency**: locating a file quickly.
- **Naming**: user convenience
 - allow two (or, more generally, N) users to have the same name for different files
 - allow one file have several different names
- **Grouping**: logical grouping of files by properties, e.g., "all Java programs", "all games"

3.2

EARLY ATTEMPTS

- **Single-level**: one directory shared between all users
 - naming problem
 - grouping problem
- **Two-level directory**: one directory per user
 - access via pathname (e.g., `bob:hello.java`)
 - can have same filename for different user
 - ... but still no grouping capability.

Add a general hierarchy for more flexibility

3.3

STRUCTURE: TREE

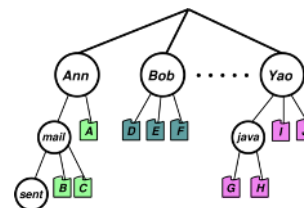

Directories hold files or [further] directories, reflecting structure of organisation, users' files, etc

Create/delete files relative to a given directory

Efficient searching and arbitrary grouping capability

The human name is then the full path name, though these can get unwieldy,

e.g., `/usr/groups/X11R5/src/mit/server/os/4.2bsd/utls.c`. Resolve with **relative naming**, **login directory**, **current working directory**. Sub-directory deletion either by requiring directory empty, or by recursively deleting

3.4

STRUCTURE: DAG

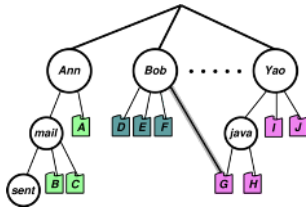

Hierarchy useful but only allows one name per file. Extend to **directed acyclic graph** (DAG) structure: allow shared subdirectories and files, and multiple aliases for same thing

Manage dangling references: use back-references or reference counts

Other issues include: **deletion** (more generally, permissions) and knowing when ok to free disk blocks; **accounting** and who gets "charged" for disk usage; and **cycles**, and how we prevent them

3.6

DIRECTORY IMPLEMENTATION

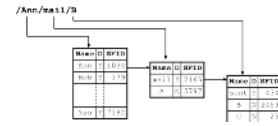

Directories are non-volatile so store as "files" on disk, each with own SFID

- Must be different types of file, for traversal
- Operations must also be explicit as info in directory used for access control, or could (eg) create cycles
- Explicit directory operations include:
 - Create/delete directory
 - List contents
 - Select current working directory
 - Insert an entry for a file (a "link")

3.6

FILES

- File Concepts
- Directories
- Files
 - Operations
 - Implementation
 - Access Control, Existence Control, Concurrency Control

4.1

OPERATIONS

Basic paradigm of use is: open, use, close

Opening or creating a file:

UFID = open(<pathname>) or

UFID = create(<pathname>)

UFID	SFID	File Control Block (Copy)
1	23421	location on disk, size, ...
2	3250	" "
3	10532	" "
4	7122	" "
...

- Directory service recursively searching directories for components of <pathname>
- Eventually get SFID for file, from which UFID created and returned
- Various modes can be used

Closing a file: status = close(UFID)

- Copy [new] file control block back to disk and invalidate UFID

4.2

IMPLEMENTATION

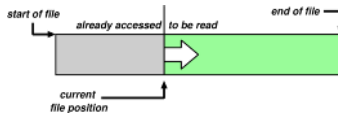

Associate a cursor or file position with each open file (viz. UFID), initialised to start of file

- Basic operations: read next or write next, e.g., read(UFID, buf, nbytes), or read(UFID, buf, nrecords)

Access pattern:

- **Sequential**: adds rewind(UFID) to above
- **Direct Access**: read(N) or write(N) using seek(UFID, pos)
- Maybe others, e.g., append-only, indexed sequential access mode (ISAM)

4.3

ACCESS CONTROL

File owner/creator should be able to control what can be done, by whom

- File usually only accessible if user has both directory and file access rights
- Former to do with lookup process – can't look it up, can't open it
- Assuming a DAG structure, do we use the presented or the absolute path

Access control normally a function of directory service so checks done at file open time

- E.g., read, write, execute, (append?), delete, list, rename
- More advanced schemes possible (see later)

4.4

EXISTENCE CONTROL

What if a user deletes a file?

- Probably want to keep file in existence while there is a valid pathname referencing it
- Plus check entire FS periodically for garbage
- Existence control can also be a factor when a file is renamed/moved.

CONCURRENCY CONTROL

Need some form of locking to handle simultaneous access

- Can be mandatory or advisory
- Locks may be shared or exclusive
- Granularity may be file or subset

4.6

SUMMARY

- File Concepts
 - Filesystems
 - Naming Files
 - File Metadata
- Directories
 - Name Space Requirements
 - Structure
 - Implementation
- Files
 - Operations
 - Implementation
 - Access Control, Existence Control, Concurrency Control

5

[11] CASE STUDY: UNIX

OUTLINE

- Introduction
- Design Principles
 - Structural, Files, Directory Hierarchy
- Filesystem
 - Files, Directories, Links, On-Disk Structures
 - Mounting Filesystems, In-Memory Tables, Consistency
- Summary

1-1

1-2

INTRODUCTION

- **Introduction**
- Design Principles
- Filesystem
- Summary

HISTORY (I)

First developed in 1969 at Bell Labs (Thompson & Ritchie) as reaction to bloated Multics. Originally written in PDP-7 asm, but then (1973) rewritten in the "new" high-level language C so it was easy to port, alter, read, etc. Unusual due to need for performance

6th edition ("V6") was widely available (1976), including source meaning people could write new tools and nice features of other OSes promptly rolled in

V6 was mainly used by universities who could afford a minicomputer, but not necessarily all the software required. The first really portable OS as same source could be built for three different machines (with minor asm changes)

Bell Labs continued with V8, V9 and V10 (1989), but never really widely available because V7 pushed to Unix Support Group (USG) within AT&T

AT&T did System III first (1982), and in 1983 (after US government split Bells), System V. There was no System IV

2-1

2-2

HISTORY (II)

By 1978, V7 available (for both the 16-bit PDP-11 and the new 32-bit VAX-11). Subsequently, two main families: AT&T "System V", currently SVR4, and Berkeley: "BSD", currently 4.4BSD

Later standardisation efforts (e.g. POSIX, X/OPEN) to homogenise

USDL did SVR2 in 1984; SVR3 released in 1987; SVR4 in 1989 which supported the POSIX.1 standard

In parallel with AT&T story, people at University of California at Berkeley (UCB) added virtual memory support to "32V" [32-bit V7 for VAX] and created 3BSD

2-3

HISTORY (III)

4BSD development supported by DARPA who wanted (among other things) OS support for TCP/IP

By 1983, 4.2BSD released at end of original DARPA project

1986 saw 4.3BSD released – very similar to 4.2BSD, but lots of minor tweaks. 1988 had 4.3BSD Tahoe (sometimes 4.3.1) which included improved TCP/IP congestion control. 19xx saw 4.3BSD Reno (sometimes 4.3.2) with further improved congestion control. Large rewrite gave 4.4BSD in 1993; very different structure, includes LFS, Mach VM stuff, stackable FS, NFS, etc.

Best known Unix today is probably Linux, but also get FreeBSD, NetBSD, and (commercially) Solaris, OSF/1, IRIX, and Tru64

2-4

SIMPLIFIED UNIX FAMILY TREE (NON-EXAMINABLE)

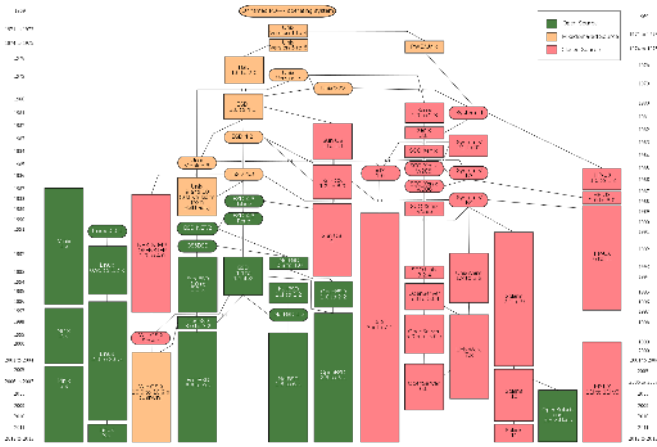

https://commons.wikimedia.org/wiki/File:Unix_history-simple.svg

DESIGN PRINCIPLES

- Introduction
- **Design Principles**
 - **Structural, Files, Directory Hierarchy**
- Filesystem
- Summary

3.1

DESIGN FEATURES

Ritchie & Thompson (CACM, July 74), identified the (new) features of Unix:

- A hierarchical file system incorporating demountable volumes
- Compatible file, device and inter-process IO (naming schemes, access control)
- Ability to initiate asynchronous processes (i.e., address-spaces = heavyweight)
- System command language selectable on a per-user basis

Completely novel at the time: prior to this, everything was "inside" the OS. In Unix separation between essential things (kernel) and everything else

Among other things: allows user wider choice without increasing size of core OS; allows easy replacement of functionality – resulted in over 100 subsystems including a dozen languages

Highly portable due to use of high-level language

Features which were not included: real time, multiprocessor support

3.2

STRUCTURAL OVERVIEW

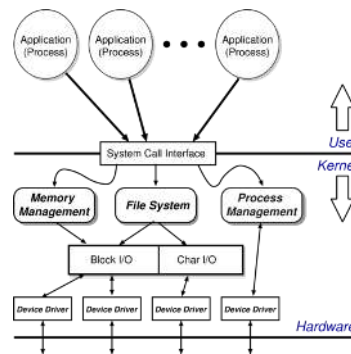

Clear separation between user and kernel portions was the big difference between Unix and contemporary systems – only the **essential** features *inside* OS, not the editors, command interpreters, compilers, etc.

Processes are unit of scheduling and protection: the command interpreter ("shell") just a process

No concurrency within kernel

All IO looks like operations on files: in Unix, everything is a file

3.3

FILESYSTEM

- Introduction
- Design Principles
- **Filesystem**
 - **Files, Directories, Links, On-Disk Structures**
 - **Mounting Filesystems, In-Memory Tables, Consistency**
- Summary

4.1

FILE ABSTRACTION

File as an unstructured sequence of bytes which was relatively unusual at the time: most systems lent towards files being composed of records

- Cons: don't get nice type information; programmer must worry about format of things inside file
- Pros: less stuff to worry about in the kernel; and programmer has flexibility to choose format within file!

Represented in user-space by a file descriptor (fd), simply an opaque identifier – a good technique for ensuring protection between user and kernel

4.2

FILE OPERATIONS

Operations on files are:

- `fd = open(pathname, mode)`
- `fd = creat(pathname, mode)`
- `bytes = read(fd, buffer, nbytes)`
- `count = write(fd, buffer, nbytes)`
- `reply = seek(fd, offset, whence)`
- `reply = close(fd)`

The kernel keeps track of the current position within the file

Devices are represented by special files:

- Support above operations, although perhaps with bizarre semantics
- Also have `ioctl` for access to device-specific functionality

4.3

DIRECTORY HIERARCHY

Directories map names to files (and directories) starting from distinguished root directory called `/`

Fully qualified pathnames mean performing traversal from root

Every directory has `.` and `..` entries: refer to self and parent respectively. Also have shortcut of **current working directory** (`cwd`) which allows relative path names; and the shell provides access to home directory as `~username` (e.g. `~mort/`). Note that kernel knows about former but not latter

Structure is a tree in general though this is slightly relaxed

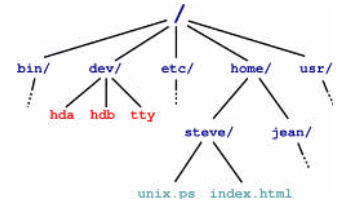

4.4

ASIDE: PASSWORD FILE

- `/etc/passwd` holds list of password entries of the form `username:encrypted-passwd:home-directory:shell`
- Also contains user-id, group-id (default), and friendly name.
- Use one-way function to encrypt passwords i.e. a function which is easy to compute in one direction, but has a hard to compute inverse. To login:
 - Get user name
 - Get password
 - Encrypt password
 - Check against version in `/etc/passwd`
 - If ok, instantiate login shell
 - Otherwise delay and retry, with upper bound on retries
- Publicly readable since lots of useful info there but permits offline attack
- Solution: shadow passwords (`/etc/shadow`)

4.5

FILE SYSTEM IMPLEMENTATION

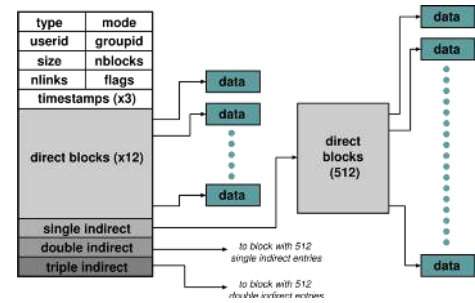

Inside the kernel, a file is represented by a data structure called an **index-node** or **i-node** which hold file meta-data: owner, permissions, reference count, etc. and location on disk of actual data (file contents)

4.6

I-NODES

- Why don't we have all blocks in a simple table?
- Why have first few in inode at all?
- How many references to access blocks at different places in the file?
- If block can hold 512 block-addresses (e.g. blocks are 4kB, block addresses are 8 bytes), what is max size of file (in blocks)?
- Where is the filename kept?

4.7

DIRECTORIES AND LINKS

Directory is (just) a file which maps filenames to i-nodes – that is, it has its own i-node pointing to its contents

An instance of a file in a directory is a (hard) link hence the reference count in the i-node. Directories can have at most 1 (real) link. Why?

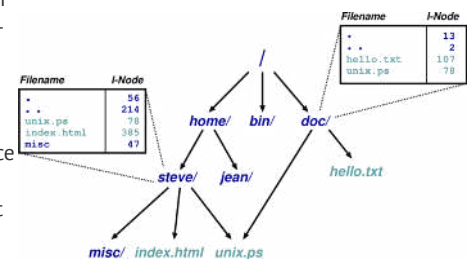

Also get soft- or symbolic-links: a 'normal' file which contains a filename

4.8

ON-DISK STRUCTURES

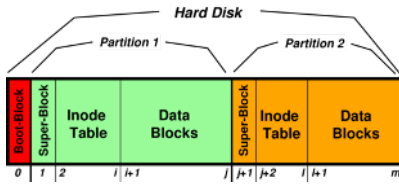

A disk consists of a boot block followed by one or more partitions. Very old disks would have just a single partition. Nowadays have a **boot block** containing a partition table allowing OS to determine where the filesystems are

Figure shows two completely independent filesystems; this is not replication for redundancy. Also note |inode table| >> |superblock|; |data blocks| >> |inode table|

4-9

ON-DISK STRUCTURES

A partition is just a contiguous range of N fixed-size blocks of size k for some N and k , and a Unix filesystem resides within a partition

Common block sizes: 512B, 1kB, 2kB, 4kB, 8kB

Superblock contains info such as:

- Number of blocks and free blocks in filesystem
- Start of the free-block and free-inode list
- Various bookkeeping information

Free blocks and inodes intermingle with allocated ones

On-disk have a chain of tables (with head in superblock) for each of these. Unfortunately this leaves superblock and inode-table vulnerable to head crashes so we must replicate in practice. In fact, now a wide range of Unix filesystems that are completely different; e.g., log-structure

4-10

MOUNTING FILESYSTEMS

Entire filesystems can be mounted on an existing directory in an already mounted filesystem

At very start, only / exists so must mount a root filesystem

Subsequently can mount other filesystems, e.g.

`mount ("/dev/hda2", "/home", options)`

Provides a unified name-space: e.g. access `/home/mort/` directly (contrast with Windows9x or NT)

Cannot have hard links across mount points: why? What about soft links?

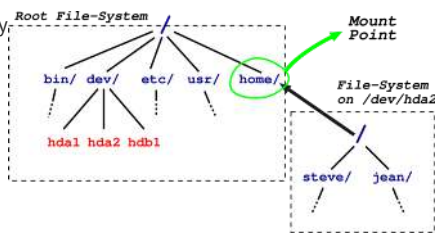

4-11

IN-MEMORY TABLES

Recall process sees files as file descriptors

In implementation these are just indices into process-specific open file table

Entries point to system-wide open file table. Why?

These in turn point to (in memory) inode table

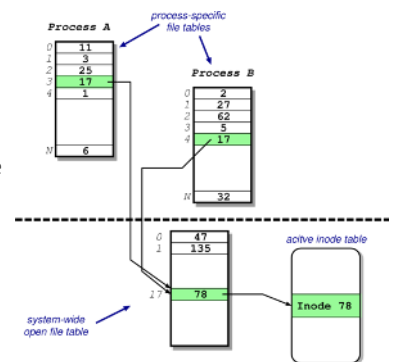

4-12

ACCESS CONTROL

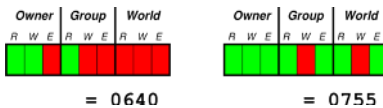

Access control information held in each inode

- Three bits for each of owner, group and world: read, write and execute
- What do these mean for directories? Read entry, write entry, traverse directory

In addition have setuid and setgid bits:

- Normally processes inherit permissions of invoking user
- Setuid/setgid allow user to "become" someone else when running a given program
- E.g. prof owns both executable test (0711 and setuid), and score file (0600)

4-13

CONSISTENCY ISSUES

To delete a file, use the `unlink` system call – from the shell, this is `rm <filename>`

Procedure is:

- Check if user has sufficient permissions on the file (must have write access)
- Check if user has sufficient permissions on the directory (must have write access)
- If ok, remove entry from directory
- Decrement reference count on inode
- If now zero: free data blocks and free inode

If crash: must check entire filesystem for any block unreferenced and any block double referenced

Crash detected as OS knows if crashed because root fs not unmounted cleanly

4-14

UNIX FILESYSTEM: SUMMARY

- Files are unstructured byte streams
- Everything is a file: "normal" files, directories, symbolic links, special files
- Hierarchy built from root (/)
- Unified name-space (multiple filesystems may be mounted on any leaf directory)
- Low-level implementation based around inodes
- Disk contains list of inodes (along with, of course, actual data blocks)
- Processes see file descriptors: small integers which map to system file table
- Permissions for owner, group and everyone else
- Setuid/setgid allow for more flexible control
- Care needed to ensure consistency

4-18

SUMMARY

- Introduction
- Design Principles
 - Structural, Files, Directory Hierarchy
- Filesystem
 - Files, Directories, Links, On-Disk Structures
 - Mounting Filesystems, In-Memory Tables, Consistency
- Summary

5

[12] CASE STUDY: UNIX

1.1

OUTLINE

- IO
 - Implementation, The Buffer Cache
- Processes
 - Unix Process Dynamics, Start of Day, Scheduling and States
- The Shell
 - Examples, Standard IO
- Main Unix Features

1.2

IO

- IO
 - **Implementation, The Buffer Cache**
- Processes
- The Shell
- Summary

2.1

IO IMPLEMENTATION

- Everything accessed via the file system
- Two broad categories: block and character; ignoring low-level gore:
 - Character IO low rate but complex – most functionality is in the "cooked" interface
 - Block IO simpler but performance matters – emphasis on the buffer cache

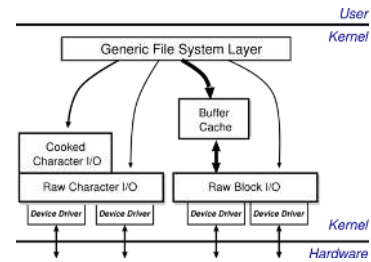

2.2

THE BUFFER CACHE

Basic idea: keep copy of some parts of disk in memory for speed

On read do:

- Locate relevant blocks (from inode)
- Check if in buffer cache
- If not, read from disk into memory
- Return data from buffer cache

On write do same first three, and then update version in cache, not on disk

- "Typically" prevents 85% of implied disk transfers
- But when does data actually hit disk?
- Call `sync` every 30 seconds to flush dirty buffers to disk
- Can cache metadata too – what problems can that cause?

2.3

PROCESSES

- IO
- **Processes**
 - **Unix Process Dynamics, Start of Day, Scheduling and States**
- The Shell
- Main Unix Features

3.1

UNIX PROCESSES

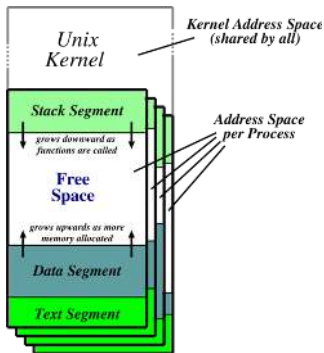

Recall: a process is a program in execution
Processes have three segments: text, data and stack. Unix processes are heavyweight

Text: holds the machine instructions for the program

Data: contains variables and their values

Stack: used for activation records (i.e. storing local variables, parameters, etc.)

3.2

UNIX PROCESS DYNAMICS

Process is represented by an opaque process id (pid), organised hierarchically with parents creating children. Four basic operations:

- `pid = fork ()`
- `reply = execve (pathname, argv, envp)`
- `exit (status)`
- `pid = wait (status)`

`fork ()` nearly always followed by `exec ()` leading to `vfork ()` and/or copy-on-write (COW). Also makes a copy of entire address space which is not terribly efficient

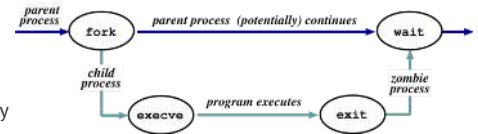

3.3

START OF DAY

Kernel (`/vmlinix`) loaded from disk (how – where's the filesystem?) and execution starts. Mounts root filesystem. Process 1 (`/etc/init`) starts hand-crafted

`init` reads file `/etc/inittab` and for each entry:

- Opens terminal special file (e.g. `/dev/tty0`)
- Duplicates the resulting fd twice.
- Forks an `/etc/tty` process.

Each `tty` process next: initialises the terminal; outputs the string `login: &` waits for input; `execve ()`'s `/bin/login`

`login` then: outputs "password:" & waits for input; encrypts password and checks it against `/etc/passwd`; if ok, sets uid & gid, and `execve ()` shell

Patriarch `init` resurrects `/etc/tty` on exit

3.4

UNIX PROCESS SCHEDULING (I)

- Priorities 0–127; user processes \geq PUSER = 50. Round robin within priorities, quantum 100ms.
- Priorities are based on usage and nice, i.e.

$$P_j(i) = \text{Base}_j + \frac{\text{CPU}_j(i-1)}{4} + 2 \times \text{nice}_j$$

gives the priority of process j at the beginning of interval i where:

$$\text{CPU}_j(i) = \frac{2 \times \text{load}_j}{(2 \times \text{load}_j) + 1} \text{CPU}_j(i-1) + \text{nice}_j$$

and nice_j is a (partially) user controllable adjustment parameter in the range $[-20, 20]$

- load_j is the sampled average length of the run queue in which process j resides, over the last minute of operation

3.5

UNIX PROCESS SCHEDULING (II)

- Thus if e.g. load is 1 this means that roughly 90% of 1s CPU usage is "forgotten" within 5s
- Base priority divides processes into bands; CPU and nice components prevent processes moving out of their bands. The bands are:
 - Swapper; Block IO device control; File manipulation; Character IO device control; User processes
 - Within the user process band the execution history tends to penalize CPU bound processes at the expense of IO bound processes

3.6

UNIX PROCESS STATES

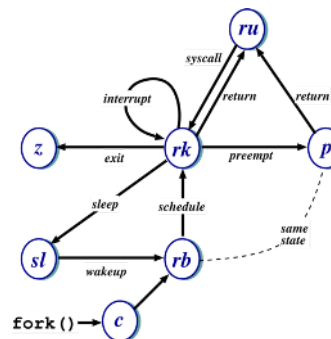

ru = running (user-mode)	rk = running (kernel-mode)
z = zombie	p = pre-empted
sl = sleeping	rb = runnable
c = created	

NB. This is simplified – see *Concurrent Systems* section 23.14 for detailed descriptions of all states/transitions

3.7

THE SHELL

- IO
- Processes
- The Shell
 - Examples, Standard IO
- Main Unix Features

4.1

THE SHELL

Shell just a process like everything else.
Needn't understand commands, just files

Uses path for convenience, to avoid needing fully qualified pathnames

Conventionally & specifies background

Parsing stage (omitted) can do lots: wildcard expansion ("globbing"), "tilde" processing

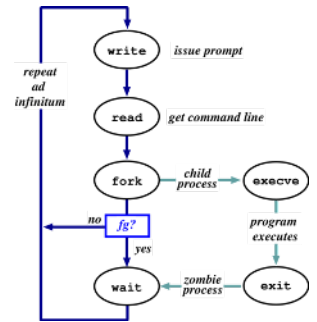

4.2

SHELL EXAMPLES

```

$ pwd
/Users/mort/src
$ ls -F
awk-scripts/  karaka/      ocamlint/    sh-scripts/
backup-scripts/ mrt.0/      opensharingtoolkit/ sockman/
bib2x-0.9.1/  ocal/       pandoc-templates/ tex/
c-utilis/     ocaml/      pttepp/      tmp/
dtrace/      ocaml-libs/ pyrt/         uon/
exaprxia-gae/ ocaml-mrt/  python-scripts/ vbox-bridge/
external/     ocaml-pst/  z/
junk/         ocaml.org/  scrapers/
$ cd python-scripts/
/Users/mort/src/python-scripts
$ ls -lF
total 224
-rw-r--r--  1 mort  staff  17987  2 Jan  2010 LICENSE
-rw-rw-r--  1 mort  staff   1692  5 Jan 09:18 README.md
-rwxr-xr-x  1 mort  staff   6206  2 Dec  2013 hberry.py*
-rwxr-xr-x  1 mort  staff   7286  14 Jul  2015 bib2json.py*
-rwxr-xr-x  1 mort  staff   7205  2 Dec  2013 cal.py*
-rw-r--r--  1 mort  staff   1860  2 Dec  2013 cc@unifdef.py
-rwxr-xr-x  1 mort  staff   1153  2 Dec  2013 filebomb.py*
    
```

Prompt is \$. Use man to find out about commands. User friendly?

4.3

STANDARD IO

Every process has three fds on creation:

- stdin: where to read input from
- stdout: where to send output
- stderr: where to send diagnostics

Normally inherited from parent, but shell allows redirection to/from a file, e.g.,

- `ls >listing.txt`
- `ls >&listing.txt`
- `sh <commands.sh`

Consider: `ls >temp.txt; wc <temp.txt >results`

- Pipeline is better (e.g. `ls | wc >results`)
- Unix commands are often filters, used to build very complex command lines
- Redirection can cause some buffering subtleties

4.4

MAIN UNIX FEATURES

- IO
- Processes
- The Shell
- Main Unix Features

5.1

MAIN UNIX FEATURES

- File abstraction
 - A file is an unstructured sequence of bytes
 - (Not really true for device and directory files)
- Hierarchical namespace
 - Directed acyclic graph (if exclude soft links)
 - Thus can recursively mount filesystems
- Heavy-weight processes
- IO: block and character
- Dynamic priority scheduling
 - Base priority level for all processes
 - Priority is lowered if process gets to run
 - Over time, the past is forgotten
- But V7 had inflexible IPC, inefficient memory management, and poor kernel concurrency
- Later versions address these issues.

5.2

SUMMARY

- IO
 - Implementation, The Buffer Cache
- Processes
 - Unix Process Dynamics, Start of Day, Scheduling and States
- The Shell
 - Examples, Standard IO
- Main Unix Features

6