

Other orthonormal 8x8 base vector sets:

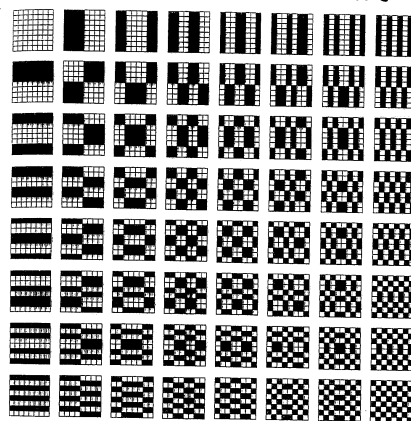

Walsh-Hadamard Transform

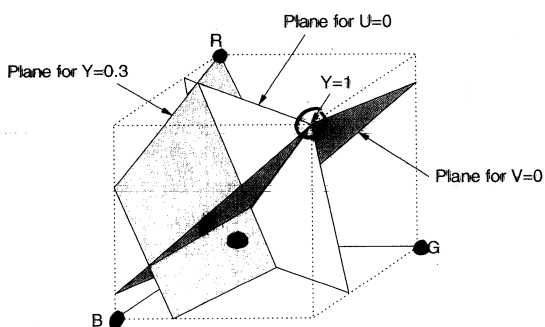

Relationship between the RGB and YUV coordinate systems

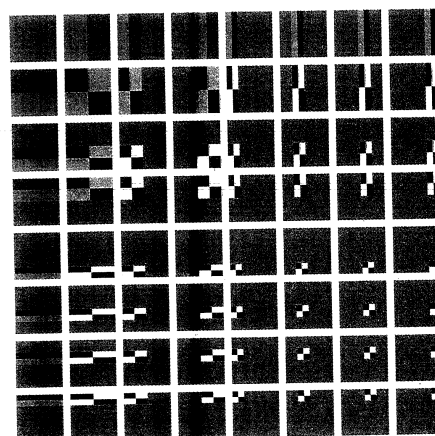

Haar Transform

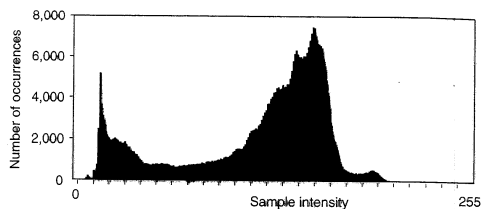

Histogram of image intensities

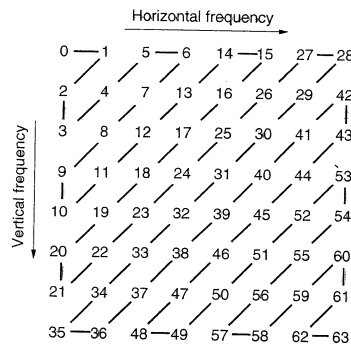

Zigzag ordering of DCT coefficients

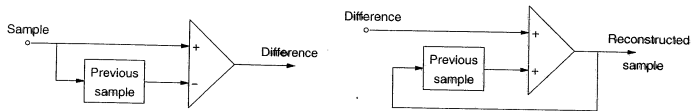

PCM encoder model

DPCM decoder model

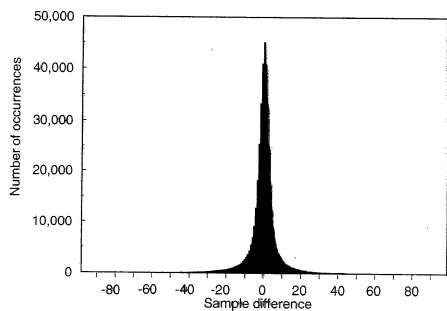

Histogram of differences between each sample and the nearest neighbor sample to left

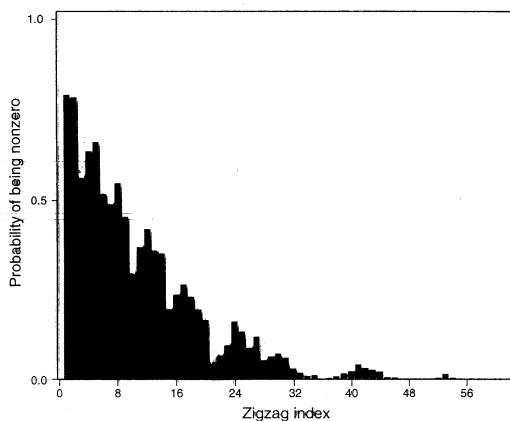

Probability of being nonzero for each AC coefficient

# Arithmetic Coding

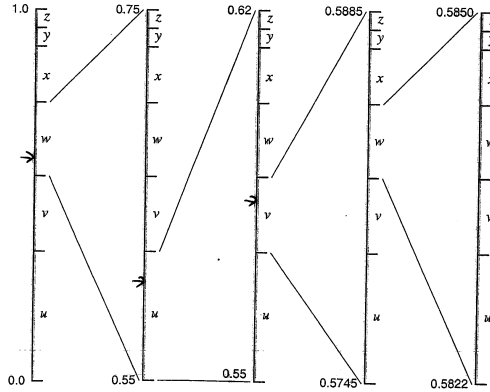
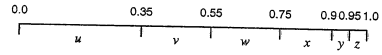
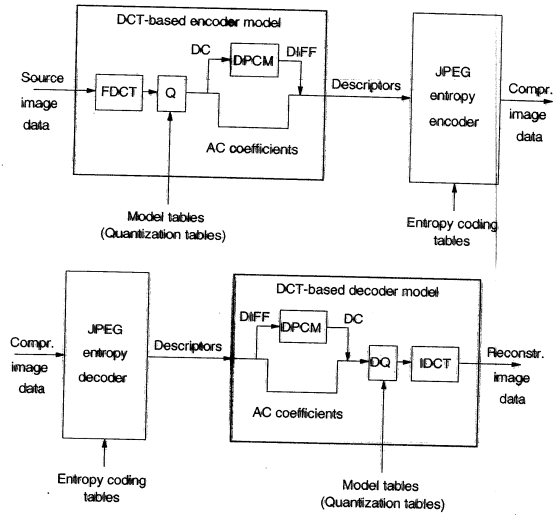

## Predictors for lossless coding

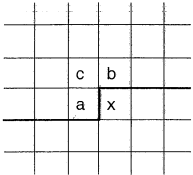

Selection-value	Prediction
0	no prediction (differential coding)
1	a
2	b
3	c
4	a + b - c
5	a + (b - c)/2
6	b + (a - c)/2
7	(a + b)/2

## Adaptive Model:

$$\hat{P}_{LPS} = \frac{n_{LPS} + \delta}{n_{LPS} + \delta + n_{MPS} + \delta}$$

$\delta = 0.45$   
in JBIG

## Bi-Level textual image compression

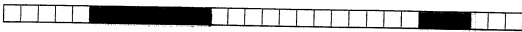

Run-length encoding: 

5	7	12	3	3
---	---	----	---	---

### Group 3 fax encoding:

run length	white	black
0	00110101	0000110111
1	0001111	010
2	0111	11
3	1000	10
4	1011	011
5	1100	0011
6	1110	0010
7	1111	00011
8	10011	000101
9	10100	000100
10	00111	0000100
11	01000	0000101
12	001000	0000111
13	000011	00000100
14	110100	00000111
15	110101	000011000
16	101010	0000010111
...	...	...
63	00110100	000001100111
64	11011	0000001111
128	10010	000011001000
192	010111	000011001001
...	...	...
1728	010011011	0000001100101

## JBIG Progressive Mode Resolution Reduction

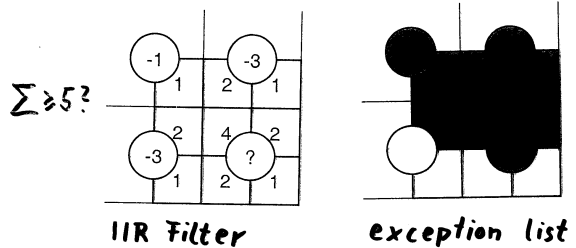

### Example



Original



Simple 2x decimation



JBIG Res. Red

# JBIG Context Templates

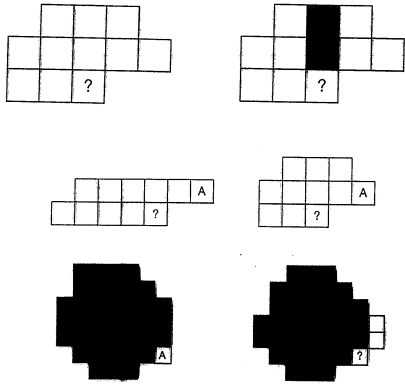

**Progressive Mode:**

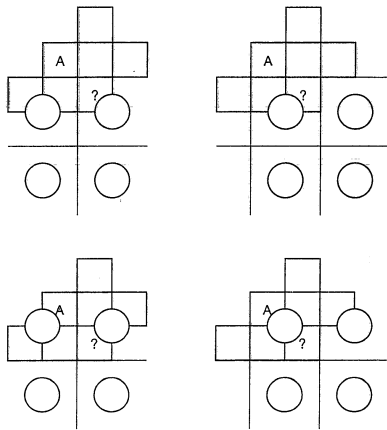

**Deterministic Prediction:**

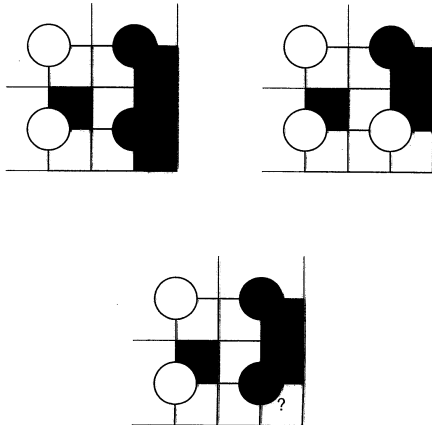

**Typical Prediction: sequential**

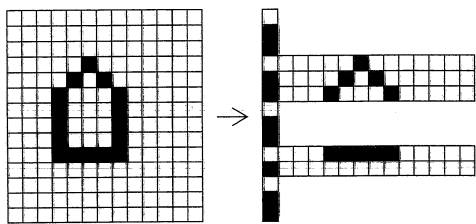

**Typical Prediction: progressive**

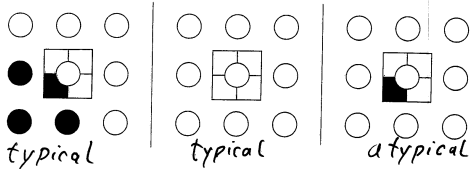

# MPEG Video Coding

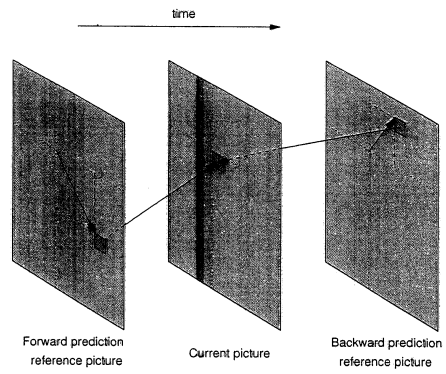

Motion compensated prediction and reconstruction.

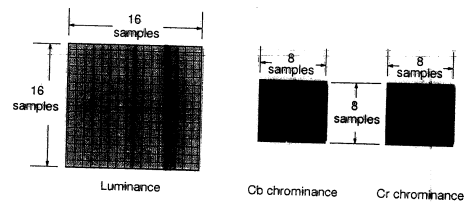

The MPEG macroblock.

# MPEG Predictive Coding

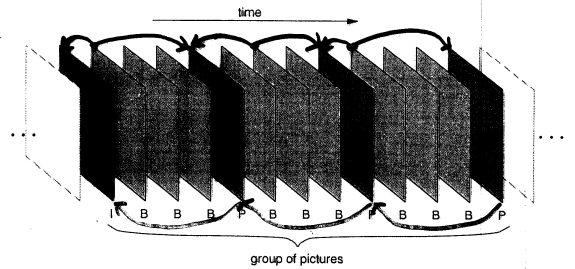

A typical group of pictures in display order.

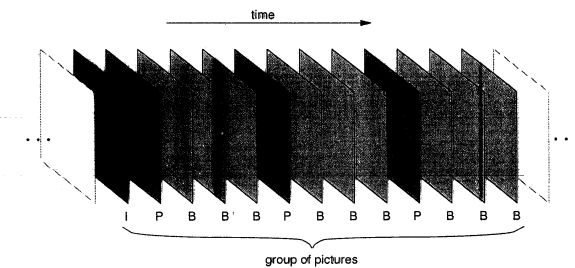

A typical group of pictures in coding order.

# MPEG System Layer

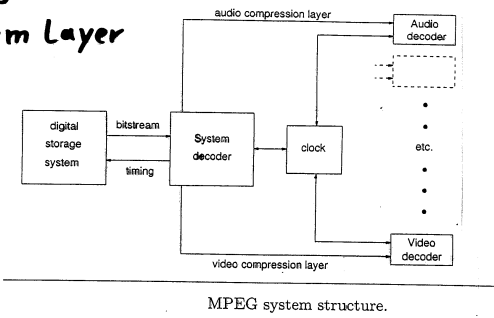

MPEG system structure.

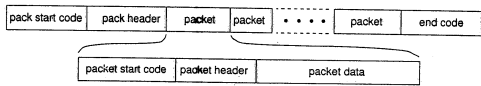

System layer pack and packet structure.

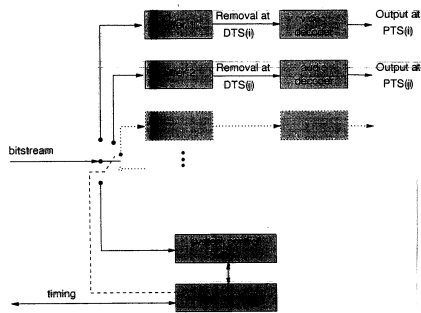

# MPEG Motion Estimation

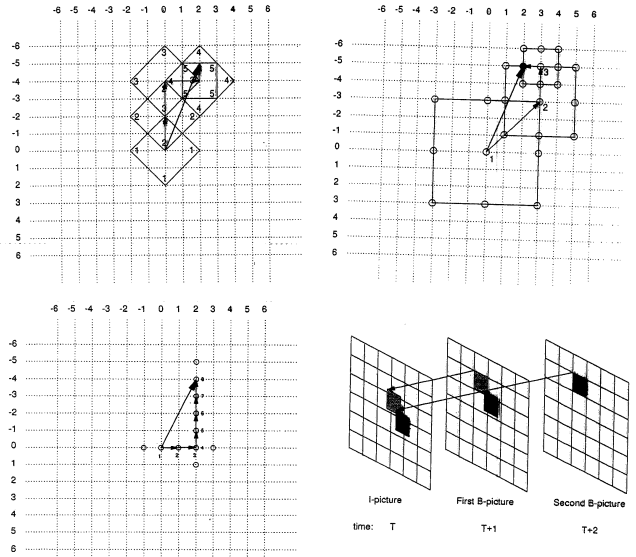
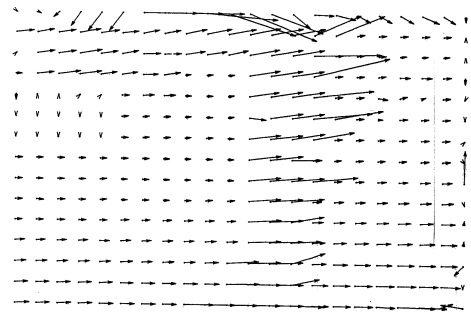

# Constant Bitrate Coding

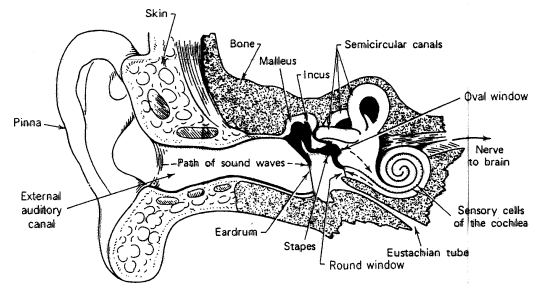
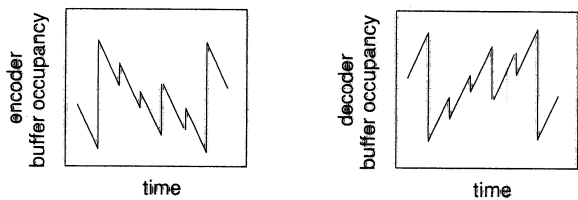
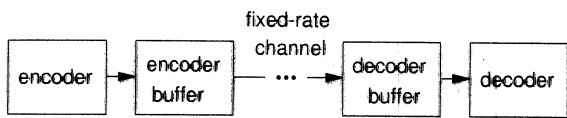

THE AUDITORY SYSTEM

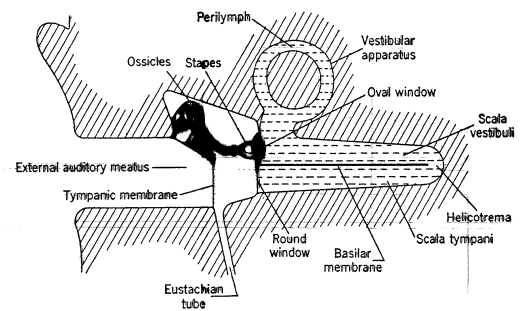

Schematic drawing of the ear. Notice that the cochlea is uncoiled in this drawing

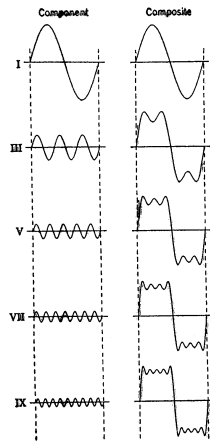
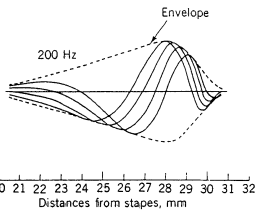
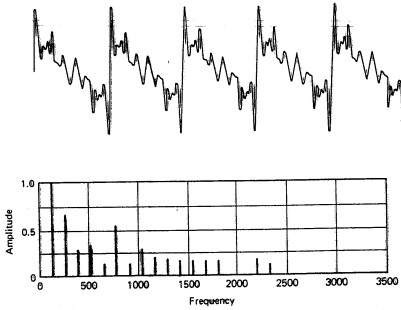
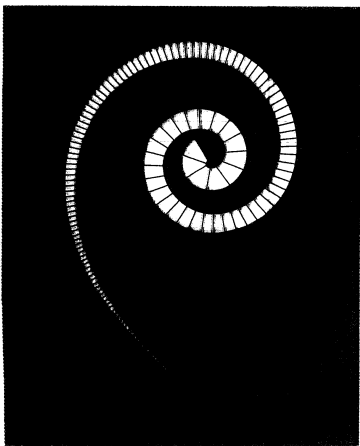

Fig. 4.8 Simple waves add up to a complex wave. The first five harmonic components of a single cycle of a "square wave" are shown in the left column. The column at right shows the progressive change from a simple sine wave as each component is added.

The waveform produced by a piano playing C = 130 Hz. The relative contribution made by each of the components is shown in the lower graph.



Various momentary positions within a cycle and the envelope formed of a traveling wave along the basilar membrane for a tone of 200 Hz.



FUNCTIONING OF THE INNER EAR

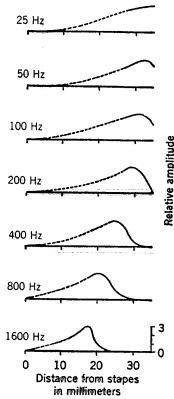

Envelopes of vibrations for various frequencies over the basilar membrane in human cadaver. The maximum displacement amplitude moves toward the stapes as frequency is increased.

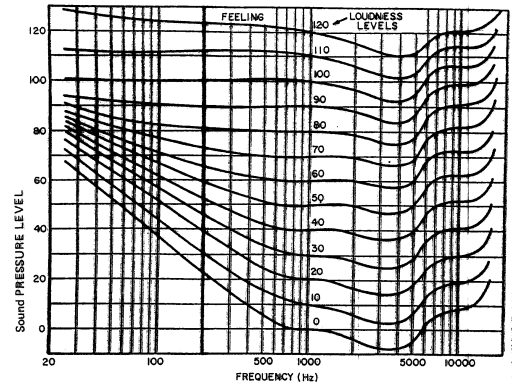

Equal loudness contours. The values by each curve refer to the loudness levels in phons. The bottom curve shows the absolute sensitivity of the ear as a function of frequency.

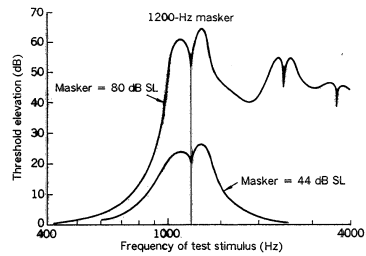
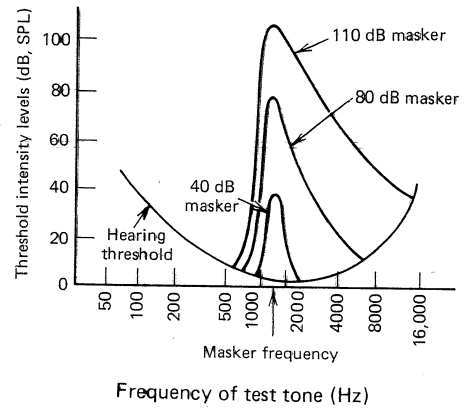

Threshold elevations in decibels for test tones of various frequencies presented in the presence of a masker (1200 Hz) at 44 and 80 dB SL. Data from Wegel and Lane (69).

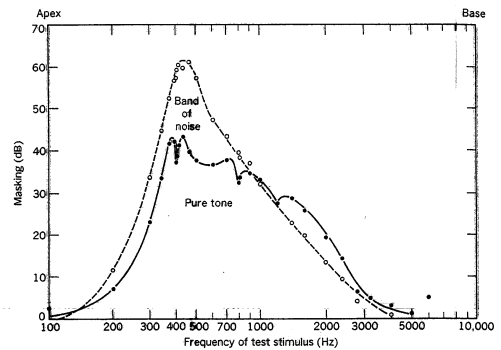

Level of masking in decibels for test tones of various frequencies presented with a masker of either an 80-dB SPL 400 Hz tone or an 80-dB SPL narrow-band noise (90 Hz) with a center frequency of 410 Hz. From Egan and Hake (11).

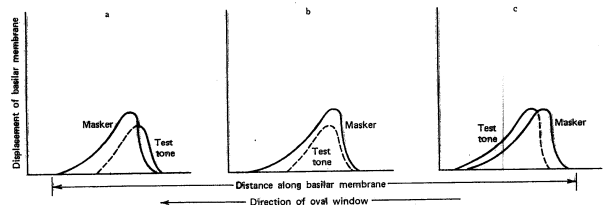

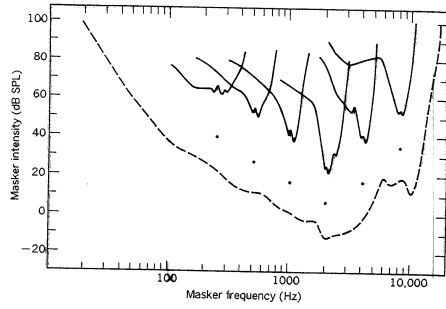

Psychophysical tuning curves using simultaneous pure-tone test stimuli at 10 dB SL. The frequency and intensity of the six test stimuli are shown by the circles. The masker intensity required for test tone detection is plotted as a function of masker frequency. The dashed line is the absolute threshold. After Vogten (63).

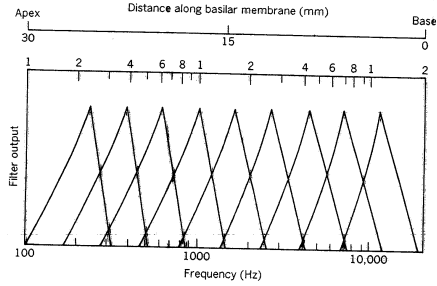

Illustrative ideal theoretical auditory filters suggested by masking experiments.

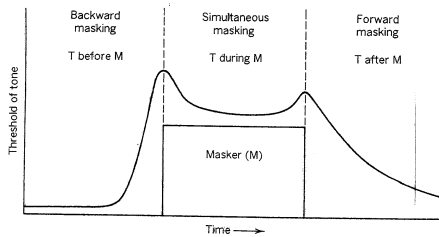

Backward, simultaneous, and forward masking, respectively. T and M refer to the test stimulus and the masker.

## MPEG Audio Coding

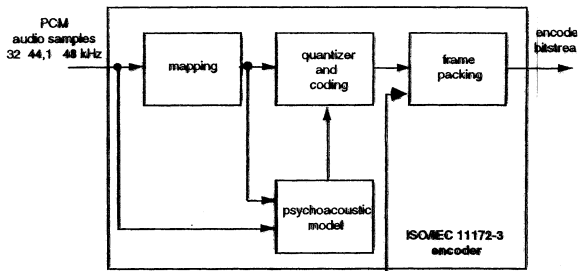

Sketch of the basic structure of an encoder

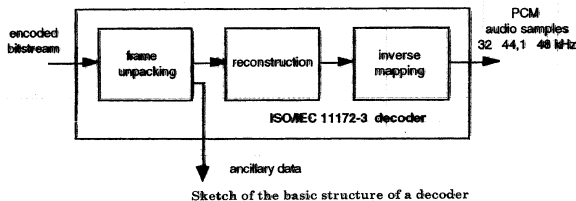

Sketch of the basic structure of a decoder

## MPEG Audio Coding

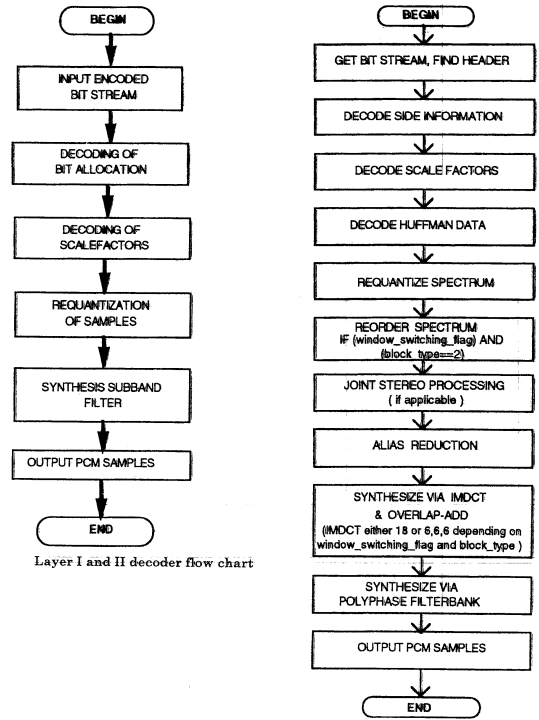

Layer I and II decoder flow chart

Layer III decoder flow chart

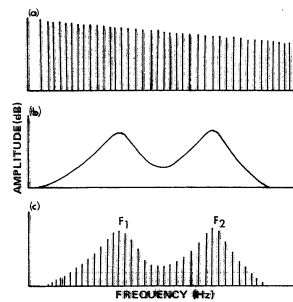
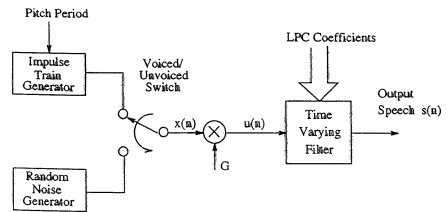

Idealized spectra showing that when the complex vocal waveform (a) is passed through the vocal tract filters (b) the resulting waveform (c) represents the acoustic characteristics of the vocal tract. Vocal tract resonances result in the formants (F<sub>1</sub>, F<sub>2</sub>).

