



Introduction to Image Processing

Advanced Graphics & Image Processing

Rafał Mantiuk

Computer Laboratory, University of Cambridge

What are Computer Graphics & Image Processing?

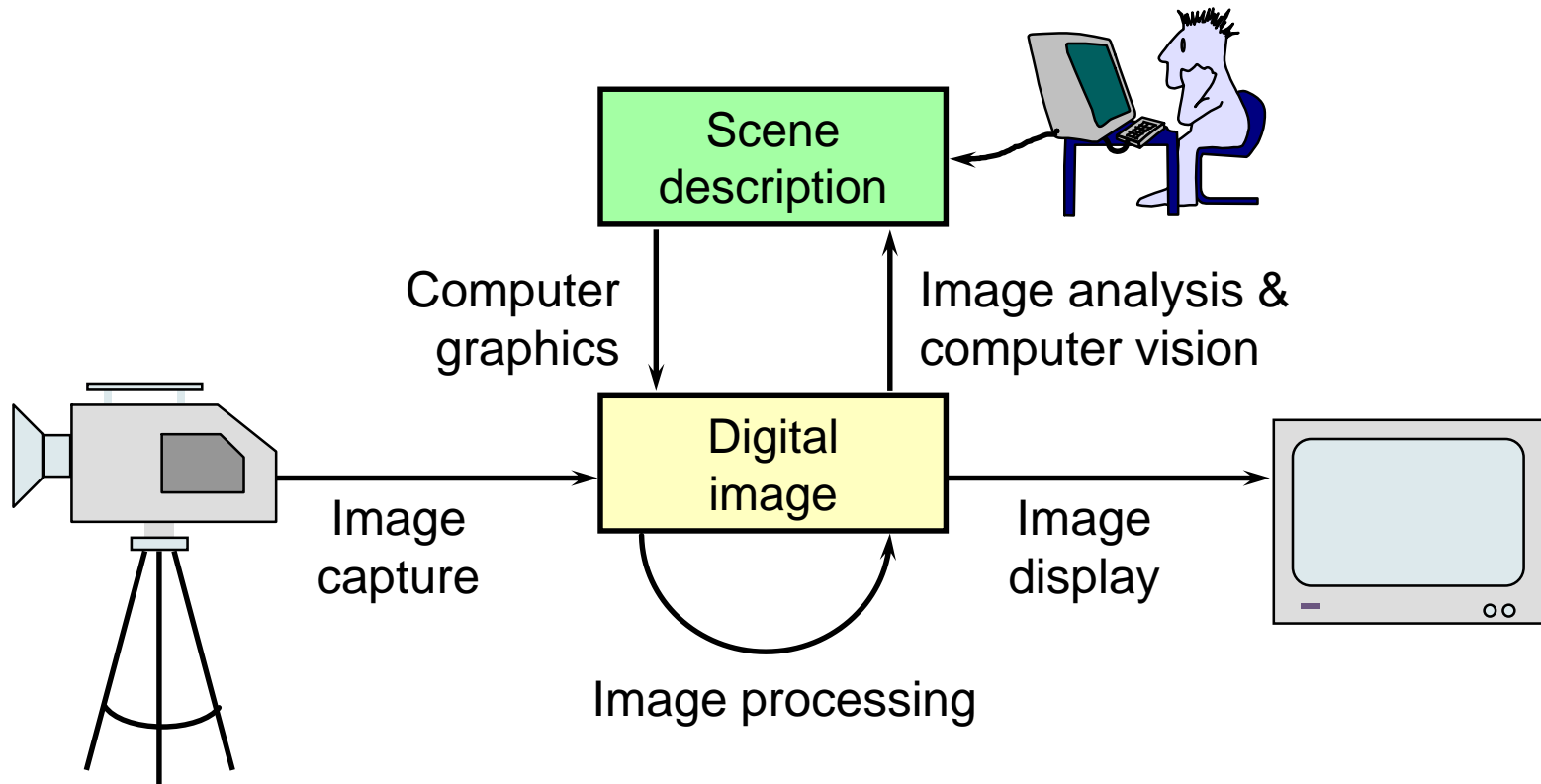

Where are graphics and image processing heading?

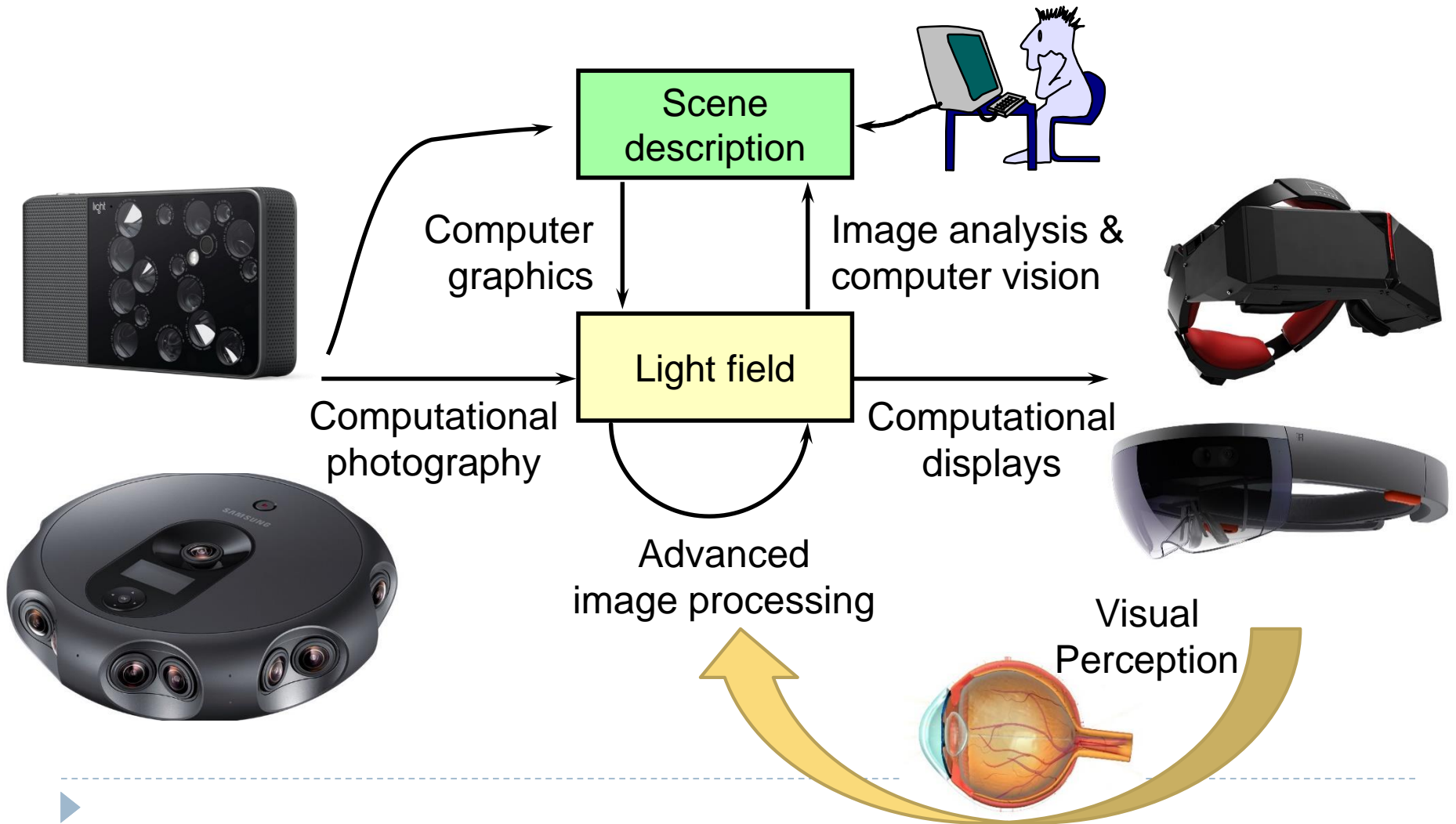

What is a (computer) image?

- ▶ A digital photograph? (“JPEG”)
- ▶ A snapshot of real-world lighting?

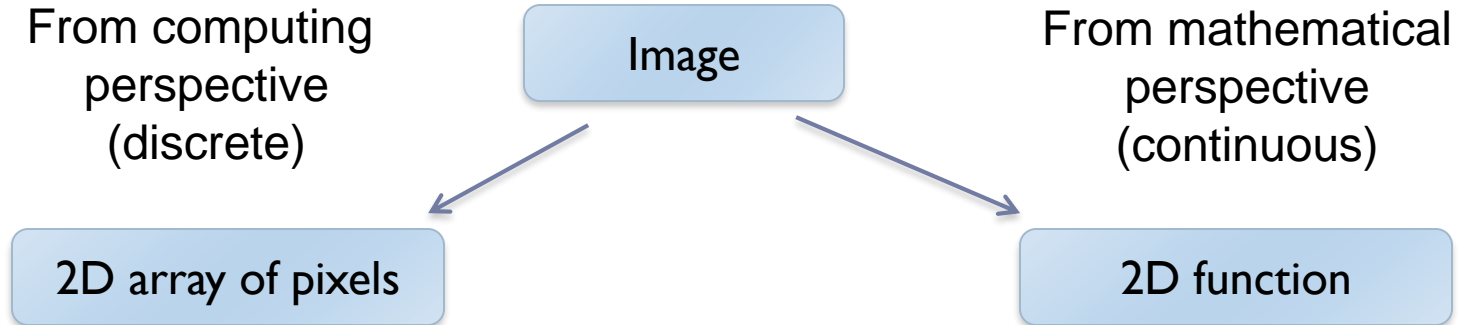

- To represent images in memory
- To create image processing software

- To express image processing as a mathematical problem
- To develop (and understand) algorithms

Image

- ▶ 2D array of pixels
- ▶ In most cases, each pixel takes 3 bytes: one for each red, green and blue
- ▶ But how to store a 2D array in memory?

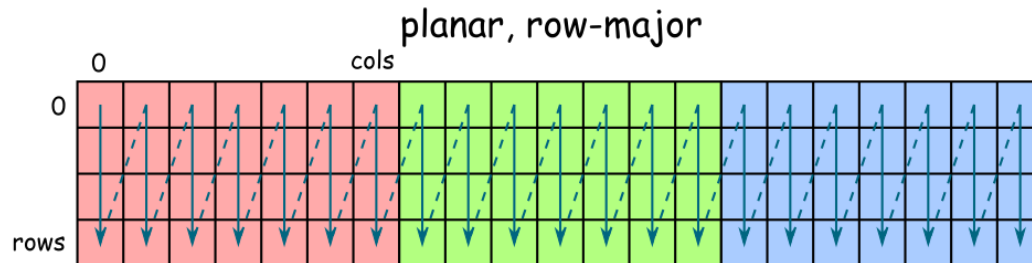
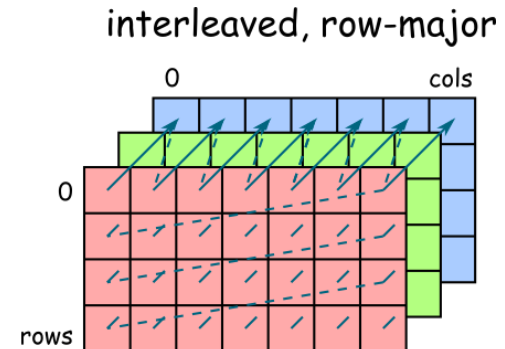
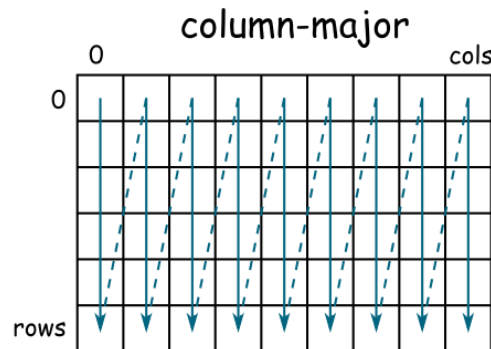
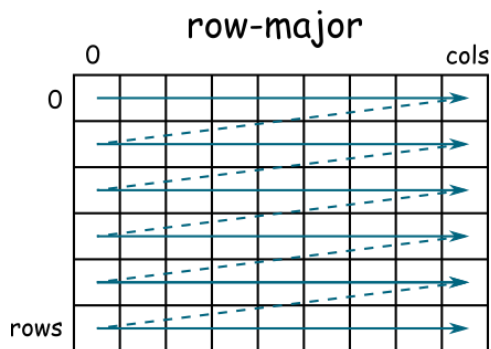

Stride

- ▶ Calculating the pixel component index in memory

- ▶ For row-major order (grayscale)

$$i(x, y) = x + y \cdot n_{cols}$$

- ▶ For column-major order (grayscale)

$$i(x, y) = x \cdot n_{rows} + y$$

- ▶ For interleaved row-major (colour)

$$i(x, y, c) = x \cdot 3 + y \cdot 3 \cdot n_{cols} + c$$

- ▶ General case

$$i(x, y, c) = x \cdot s_x + y \cdot s_y + c \cdot s_c$$

where s_x , s_y and s_c are the strides for the x, y and colour dimensions

Padded images and stride

- ▶ Sometimes it is desirable to “pad” image with extra pixels
 - ▶ for example when using operators that need to access pixels outside the image border
- ▶ Or to define a region of interest (ROI)

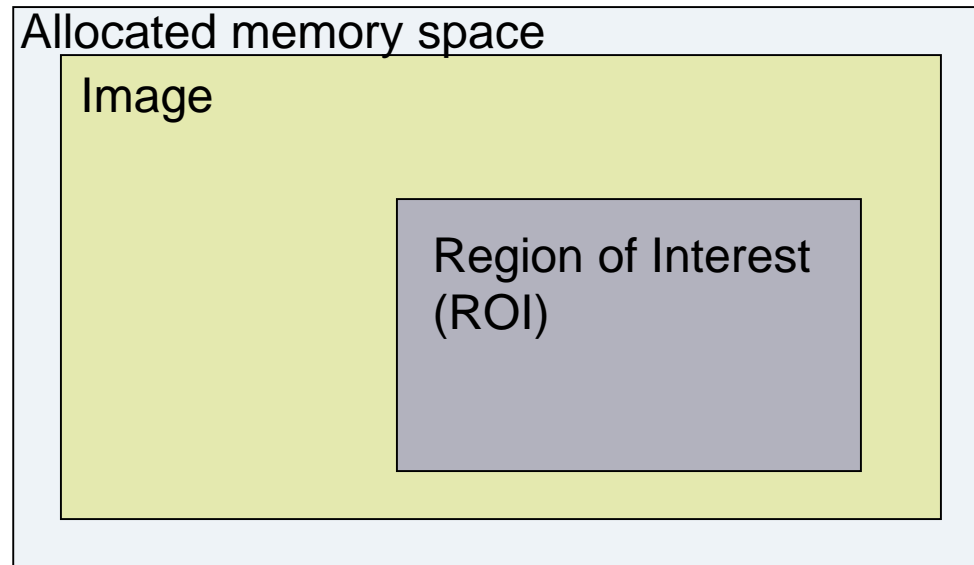

- ▶ How to address pixels for such an image and the ROI?

Padded images and stride

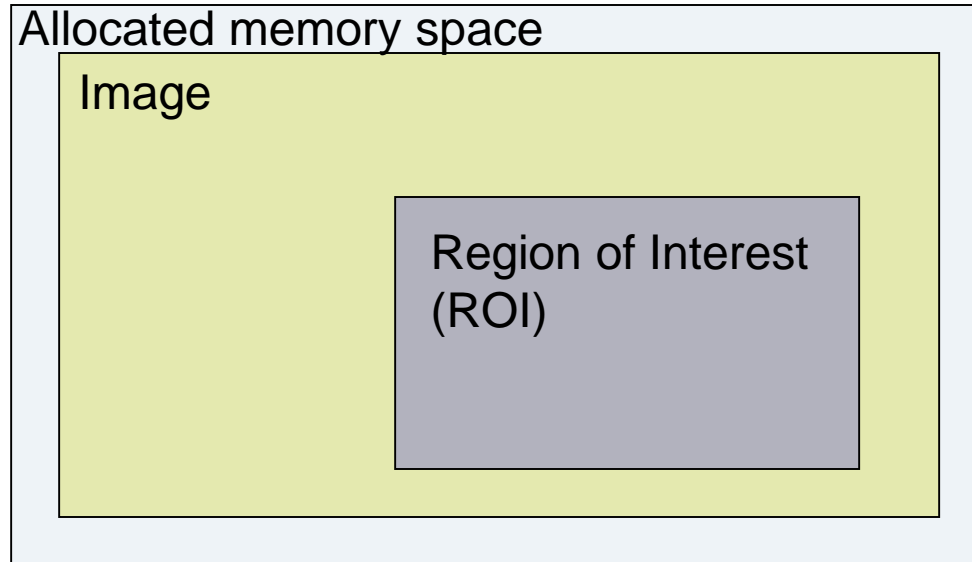

$$i(x, y, c) = i_{first} + x \cdot s_x + y \cdot s_y + c \cdot s_c$$

▶ For row-major, interleaved

- ▶ $s_x = ?$
- ▶ $s_y = ?$
- ▶ $s_c = ?$

Pixel (PIcture ELeMent)

- ▶ Each pixel (usually) consist of three values describing the color

(red, green, blue)

- ▶ For example
 - ▶ (255, 255, 255) for white
 - ▶ (0, 0, 0) for black
 - ▶ (255, 0, 0) for red
- ▶ Why are the values in the 0-255 range?
- ▶ Why red, green and blue? (and not cyan, magenta, yellow)
- ▶ How many bytes are needed to store 5MPixel image?
(uncompressed)

Pixel formats, bits per pixel, bit-depth

- ▶ Grayscale – single **color channel**, 8 bits (1 byte)
- ▶ Highcolor – $2^{16}=65,536$ colors (2 bytes)

Sample Length:	5					6						5				
Channel Membership:	Red					Green						Blue				
Bit Number:	15	14	13	12	11	10	9	8	7	6	5	4	3	2	1	0
RGBAX						R	G	B	A	X						
Sample Length Notation:						5.6.5.0.0										

- ▶ Truecolor – $2^{24} = 16,8$ million colors (3 bytes)
- ▶ Deepcolor – even more colors (≥ 4 bytes)

Sample Length:	2	10										10										10												
Channel Membership:	None	Red										Green										Blue												
Bit Number:	31	30	29	28	27	26	25	24	23	22	21	20	19	18	17	16	15	14	13	12	11	10	9	8	7	6	5	4	3	2	1	0		
RGBAX			R										G										B										A	X
Sample Length Notation:			10.10.10.0.2																															

▶ But why?

Color banding

- ▶ If there are not enough bits to represent color
- ▶ Looks worse because of the **Mach band** illusion
- ▶ Dithering (added noise) can reduce banding
 - ▶ Printers
 - ▶ Many LCD displays do it too

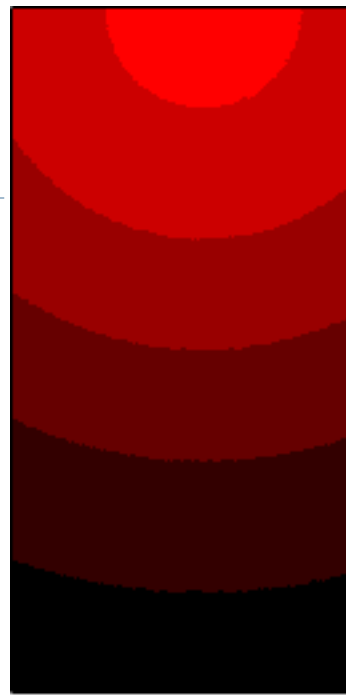

8-bit gradient



8-bit gradient,
dithered



24-bit gradient



What is a (computer) image?

- ▶ A digital photograph? (“JPEG”)
- ▶ A snapshot of real-world lighting?

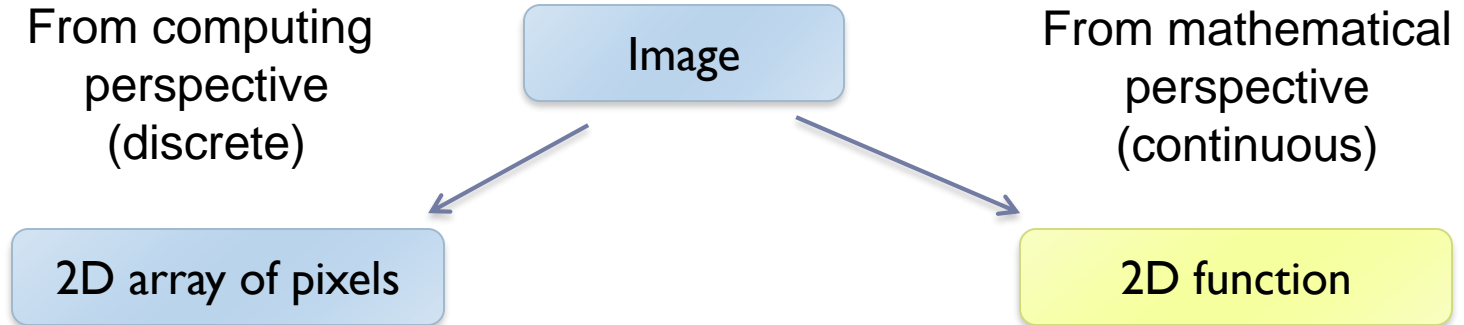

- To represent images in memory
- To create image processing software

- To express image processing as a mathematical problem
- To develop (and understand) algorithms

Image – 2D function

- ▶ Image can be seen as a function $I(x,y)$, that gives intensity value for any given coordinate (x,y)



Sampling an image

- ▶ The image can be sampled on a rectangular sampling grid to yield a set of samples. These samples are pixels.

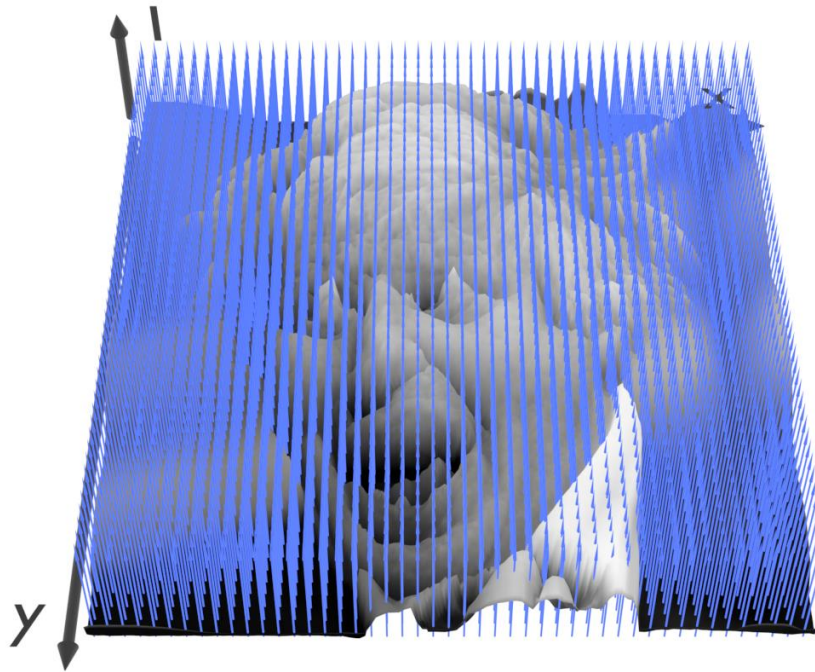

What is a pixel? (math)

- ▶ A pixel is not
 - ▶ a box
 - ▶ a disk
 - ▶ a teeny light

- ▶ A pixel is a point
 - ▶ it has no dimension
 - ▶ it occupies no area
 - ▶ it cannot be seen
 - ▶ it has coordinates

- ▶ A pixel is a **sample**

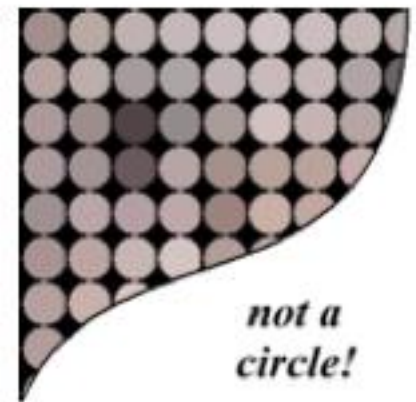
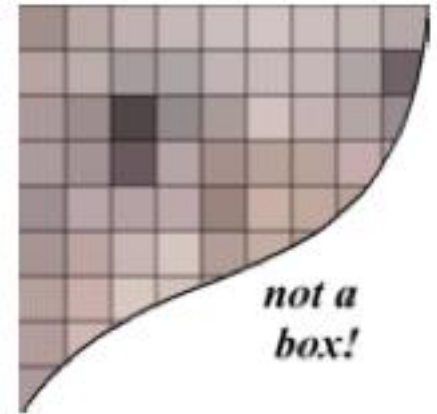

Sampling and quantization

- ▶ Physical world is described in terms of continuous quantities
- ▶ But computers work only with discrete numbers
- ▶ Sampling – process of mapping continuous function to a discrete one
- ▶ Quantization – process of mapping continuous variable to a discrete one

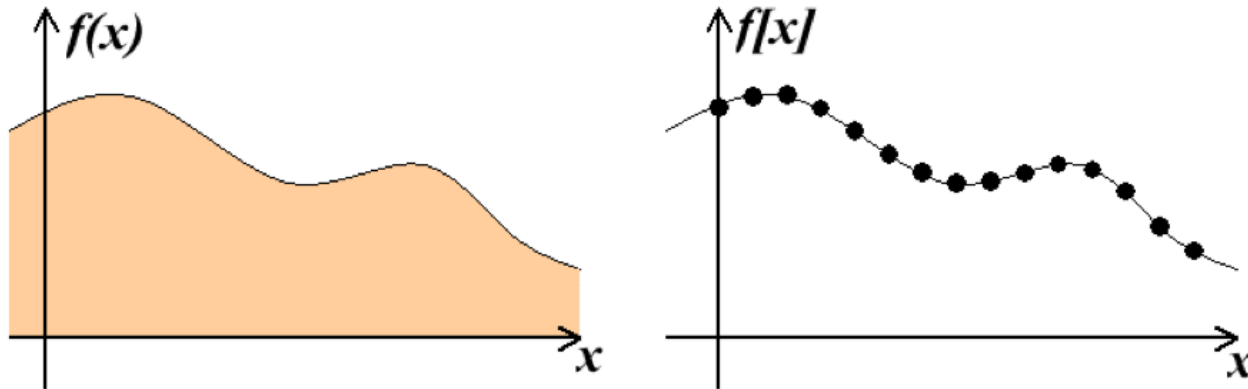

Resampling

- ▶ Some image processing operations require to know the colors that are in-between the original pixels

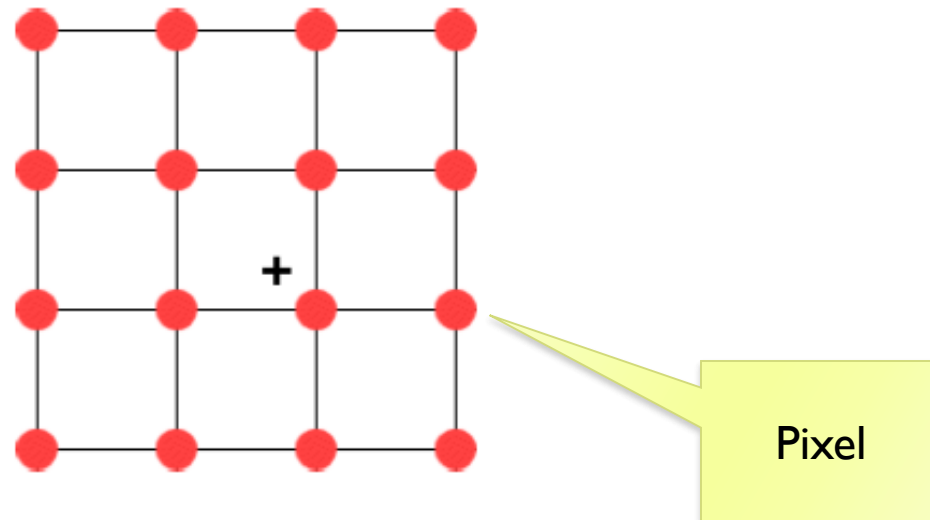

- ▶ What are those operations?
- ▶ How to find these *resampled* pixel values?

Example of resampling: magnification

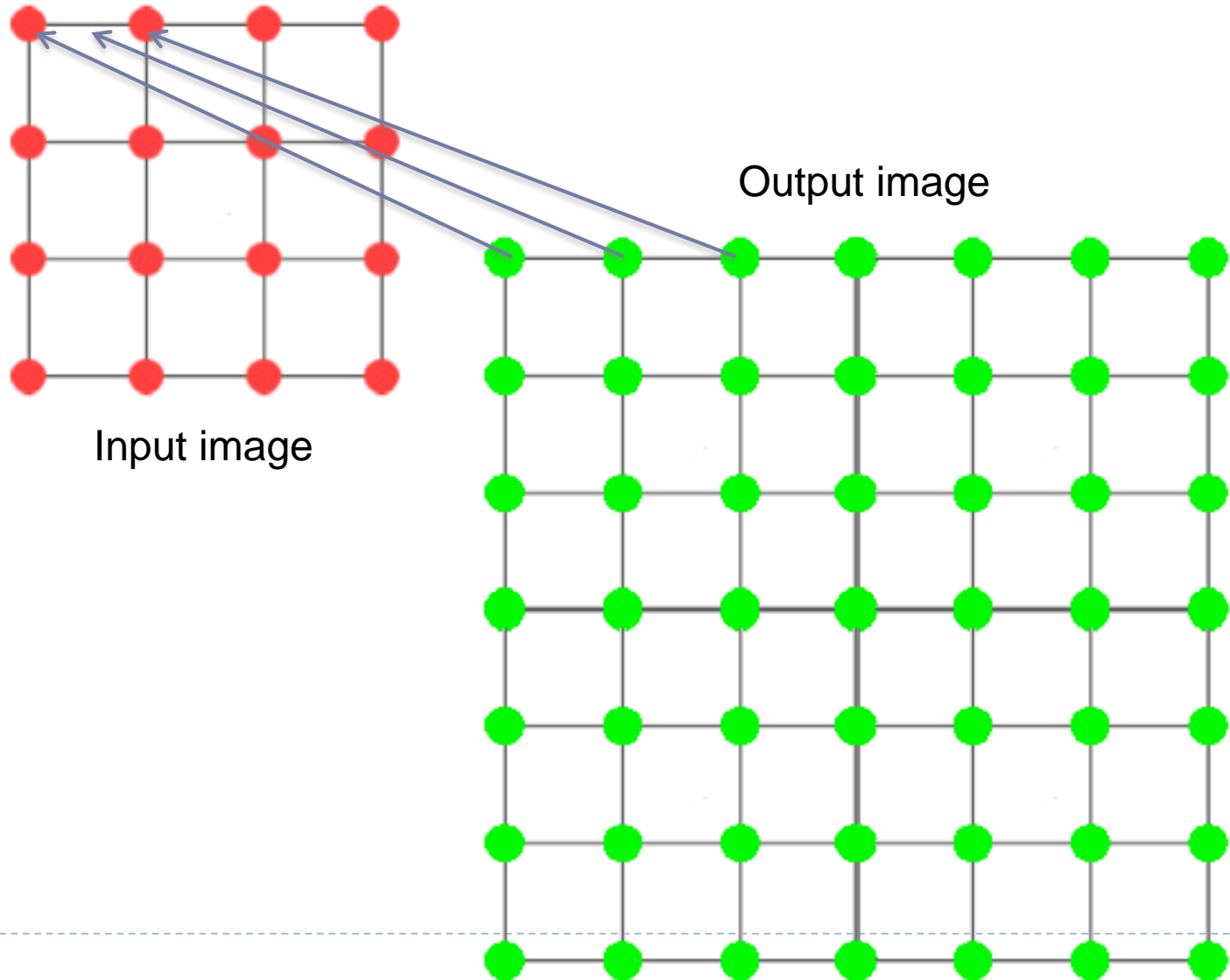

Example of resampling: scaling and rotation

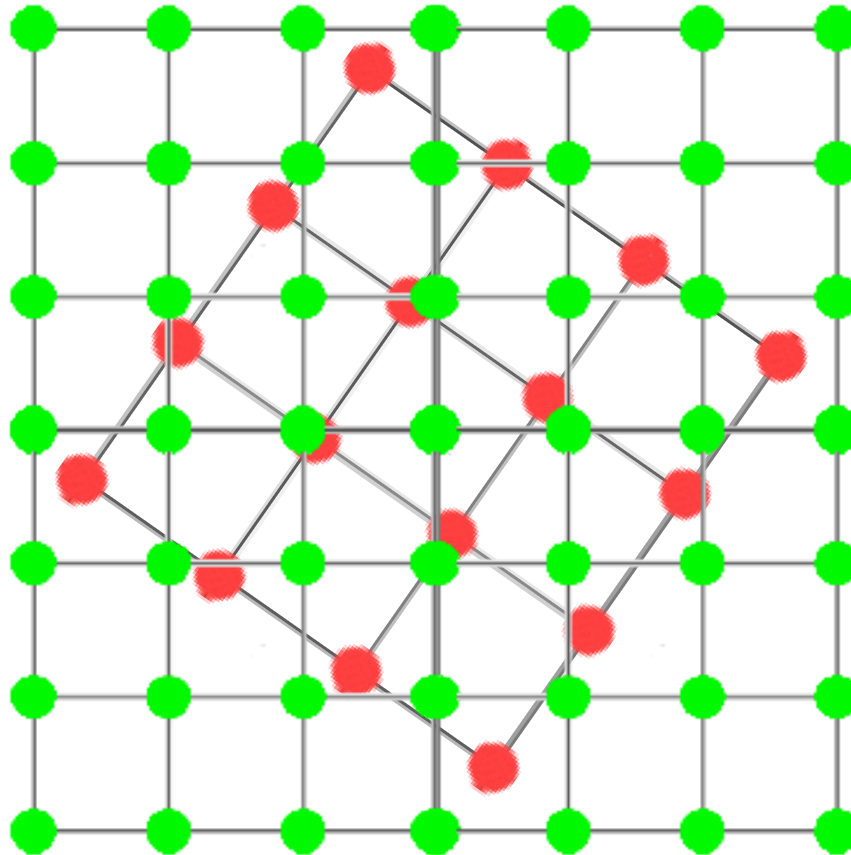

How to resample?

- ▶ In 1D: how to find the most likely resampled pixel value knowing its two neighbors?

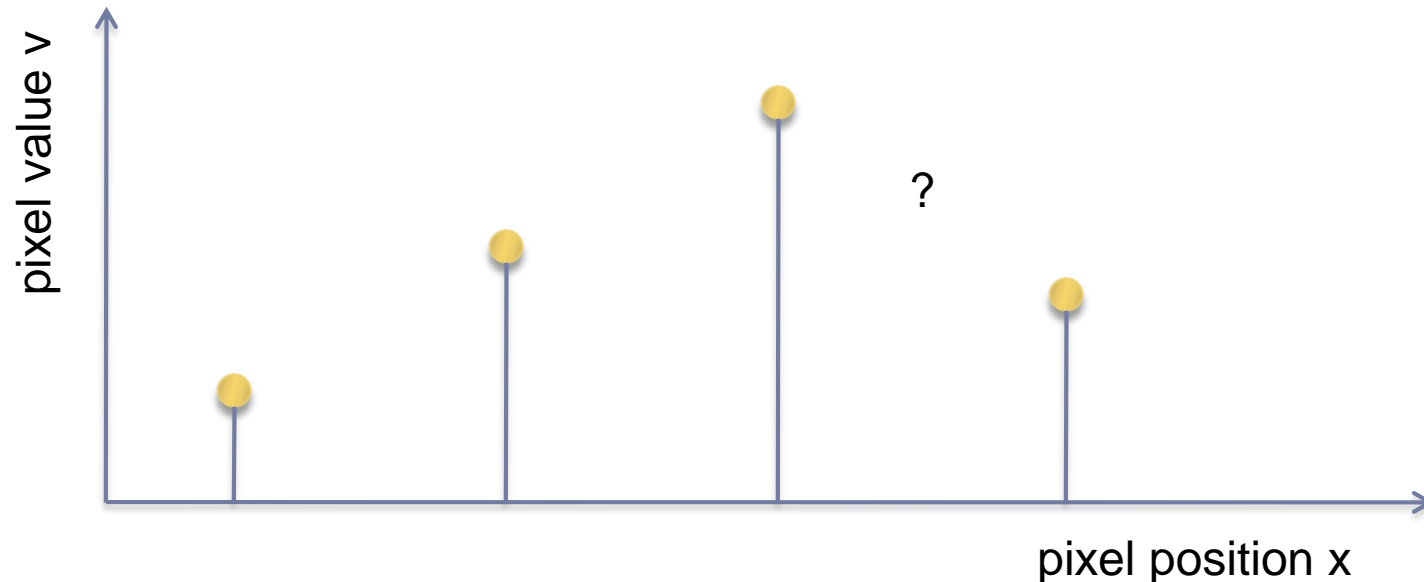

(Bi)Linear interpolation (resampling)

- ▶ Linear – 1D
- ▶ Bilinear – 2D

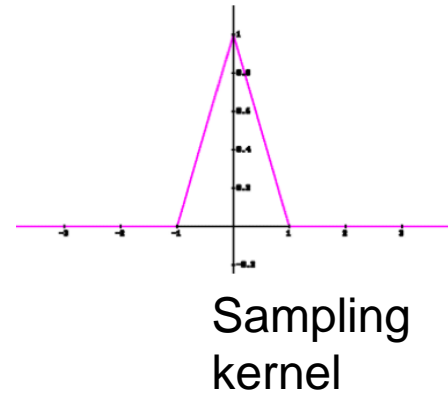
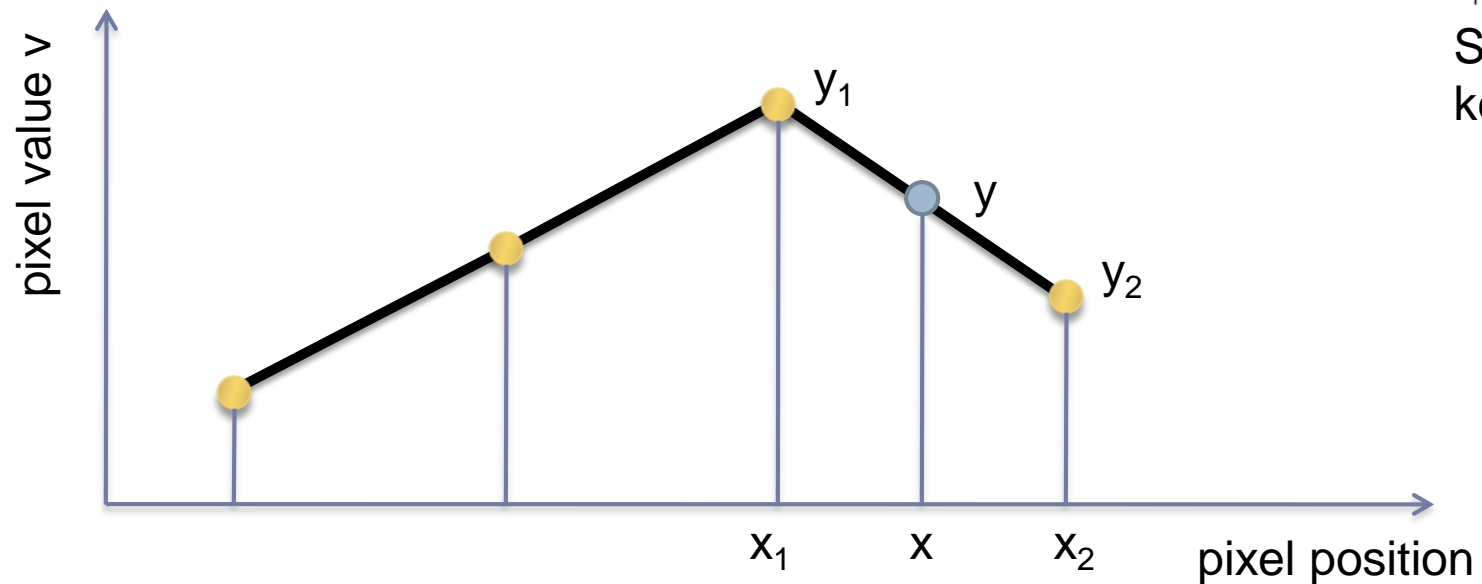

(Bi)cubic interpolation (resampling)

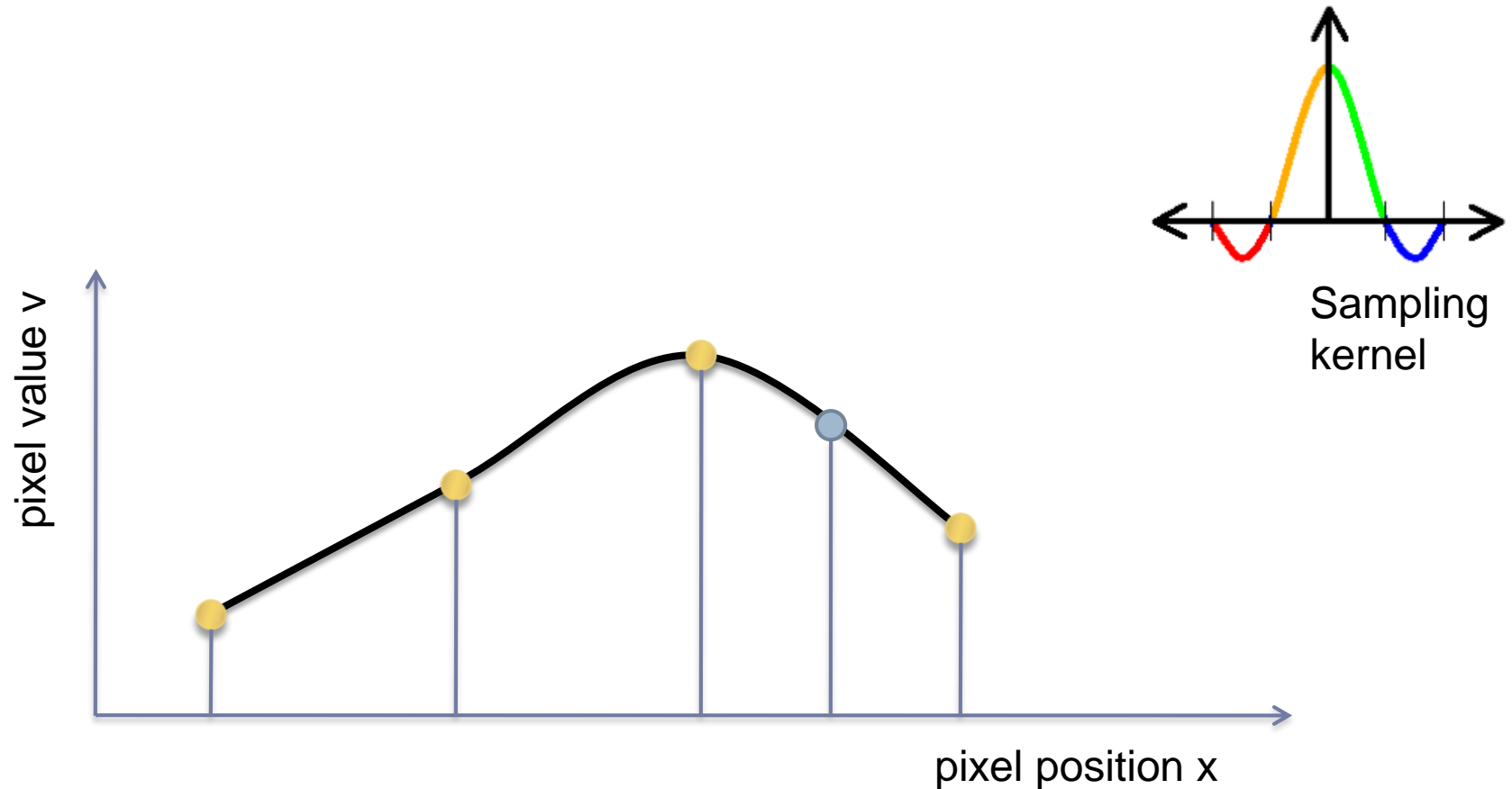

Bi-linear interpolation

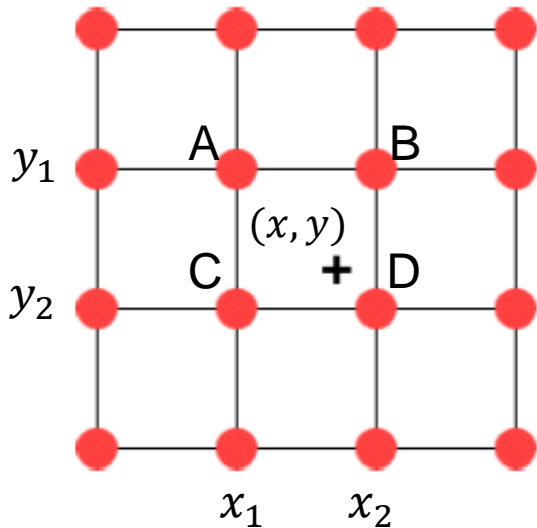

Given the pixel values:

$$I(x_1, y_1) = A$$

$$I(x_2, y_1) = B$$

$$I(x_1, y_2) = C$$

$$I(x_2, y_2) = D$$

Calculate the value of a pixel $I(x, y) = ?$ using bi-linear interpolation.

Hint: Interpolate first between A and B, and between C and D, then interpolate between these two computed values.

Point operators and filters



Original



Blurred



Sharpened



Edge-preserving filter

Point operators

- ▶ Modify each pixel independent from one another
- ▶ The simplest case: multiplication and addition

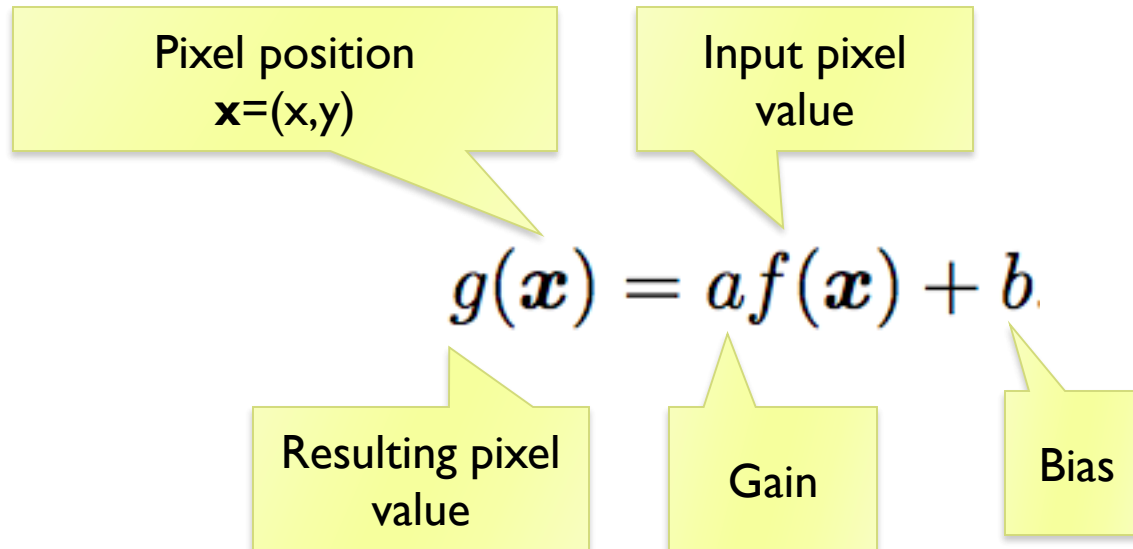

Pixel precision for image processing

- ▶ **Given an RGB image, 8-bit per color channel (uchar)**
 - ▶ What happens if the value of 10 is subtracted from the pixel value of 5 ?
 - ▶ $250 + 10 = ?$
 - ▶ How to multiply pixel values by 1.5 ?
 - ▶ a) Using floating point numbers
 - ▶ b) While avoiding floating point numbers

Image blending

- ▶ Cross-dissolve between two images

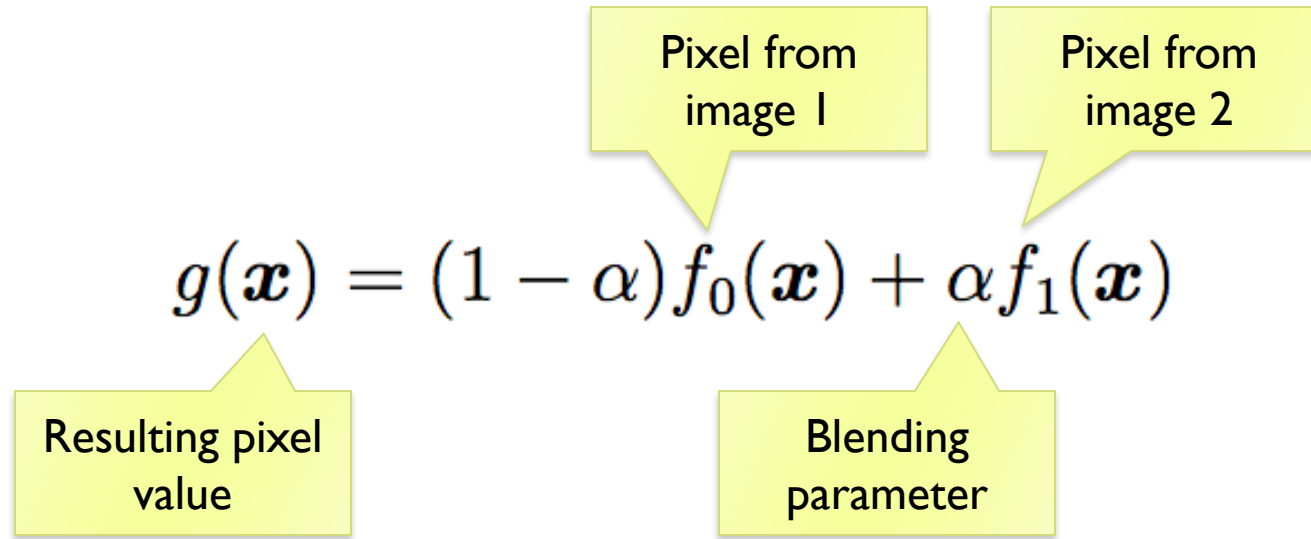

- ▶ where α is between 0 and 1

Image matting and compositing



- ▶ Matting – the process of extracting an object from the original image
- ▶ Compositing – the process of inserting the object into a different image
- ▶ It is convenient to represent the extracted object as an RGBA image

Transparency, alpha channel

- ▶ **RGBA** – red, green, blue, alpha
 - ▶ alpha = 0 – transparent pixel
 - ▶ alpha = 1 – opaque pixel
- ▶ **Compositing**
 - ▶ Final pixel value:

$$P = \alpha C_{pixel} + (1 - \alpha) C_{background}$$

- ▶ Multiple layers:

$$P_0 = C_{background}$$

$$P_i = \alpha_i C_i + (1 - \alpha_i) P_{i-1} \quad i = 1..N$$



Image histogram

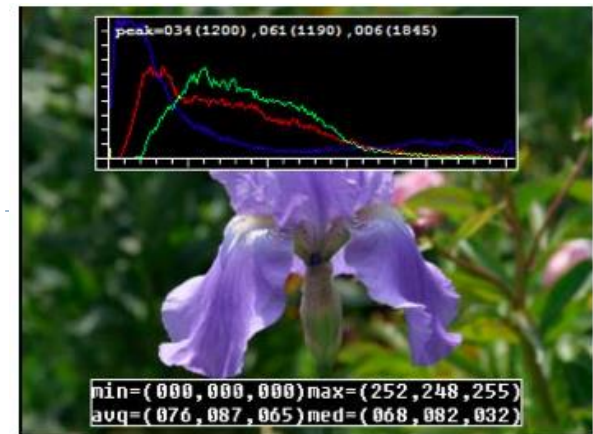
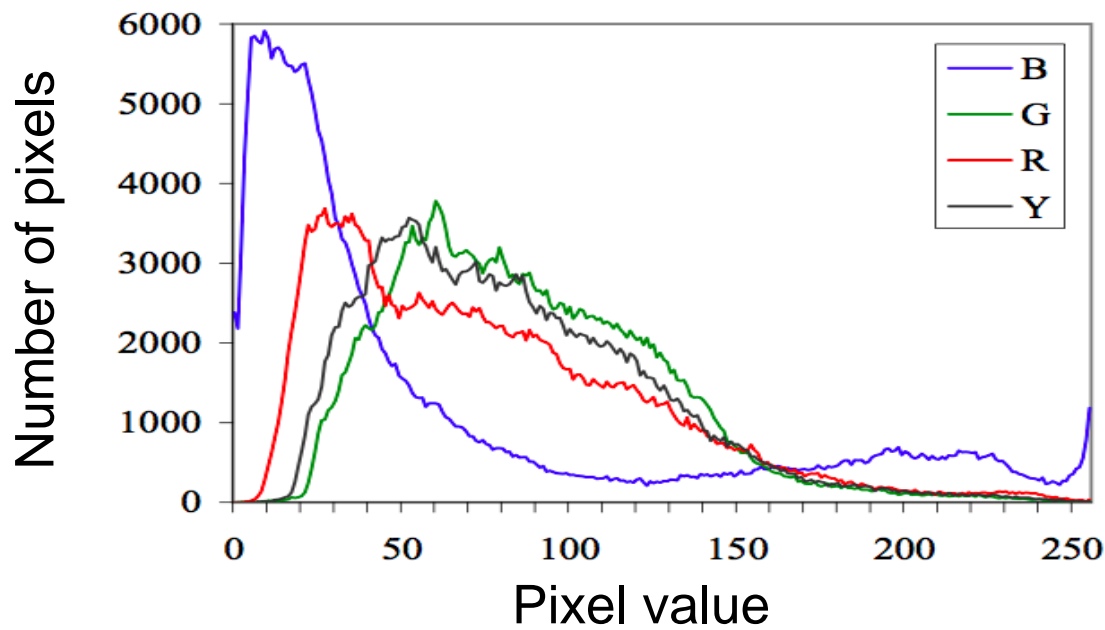

- ▶ histogram / total pixels = probability mass function
 - ▶ what probability does it represent?

Histogram equalization

- ▶ Pixels are non-uniformly distributed across the range of values

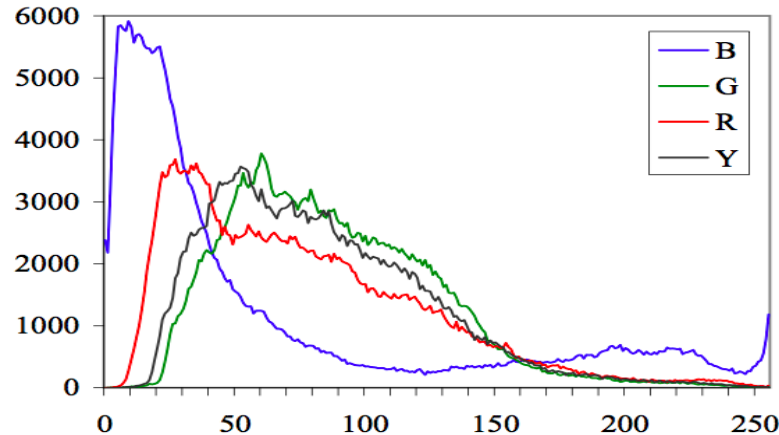

- ▶ Would the image look better if we uniformly distribute pixel values (make the histogram more uniform)?
- ▶ How can this be done?

Histogram equalization

- ▶ Step 1: Compute image histogram
- ▶ Step 2: Compute a normalized cumulative histogram

$$c(I) = \frac{1}{N} \sum_{i=0}^I h(i)$$

- ▶ Step 3: Use the cumulative histogram to map pixels to the new values (as a look-up table)

$$Y_{out} = c(Y_{in})$$

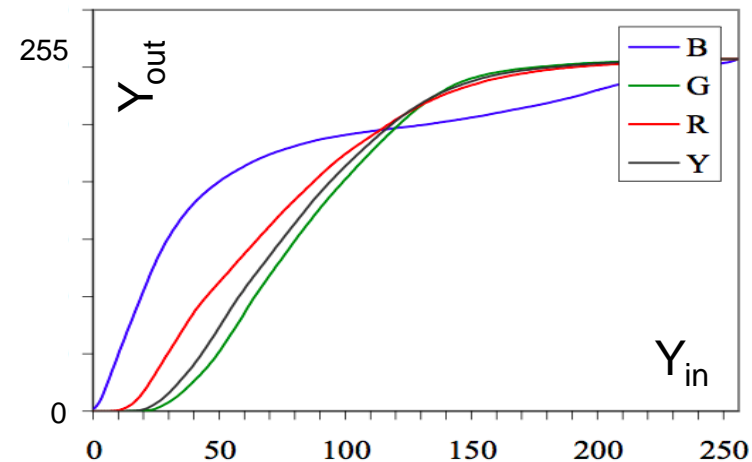
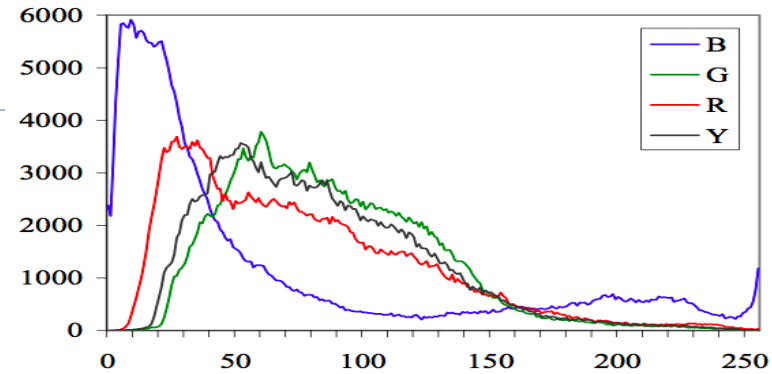

Linear filtering (revision)

- ▶ Output pixel value is a weighted sum of neighboring pixels

Input pixel value

Kernel (filter)

$$g(i, j) = \sum_{k, l} f(i - k, j - l)h(k, l)$$

Resulting pixel value

Sum over neighboring pixels, e.g. $k=-1, 0, 1, j=-1, 0, 1$ for 3x3 neighborhood

compact notation $g = f * h$

Convolution operation

Linear filter: example

45	60	98	127	132	133	137	133
46	65	98	123	126	128	131	133
47	65	96	115	119	123	135	137
47	63	91	107	113	122	138	134
50	59	80	97	110	123	133	134
49	53	68	83	97	113	128	133
50	50	58	70	84	102	116	126
50	50	52	58	69	86	101	120

$f(x,y)$

*

0.1	0.1	0.1
0.1	0.2	0.1
0.1	0.1	0.1

=

69	95	116	125	129	132
68	92	110	120	126	132
66	86	104	114	124	132
62	78	94	108	120	129
57	69	83	98	112	124
53	60	71	85	100	114

$g(x,y)$

Why is the matrix g smaller than f ?

Padding an image

Padded image

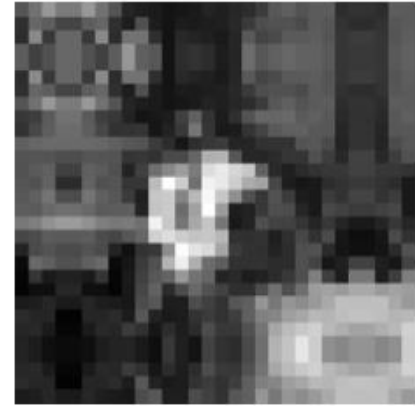
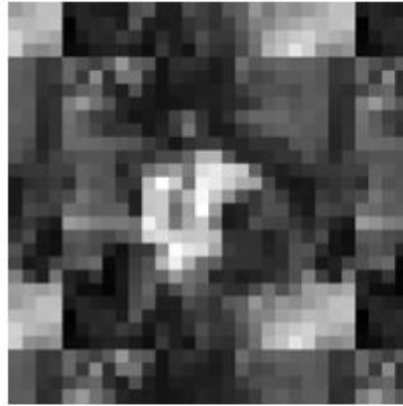
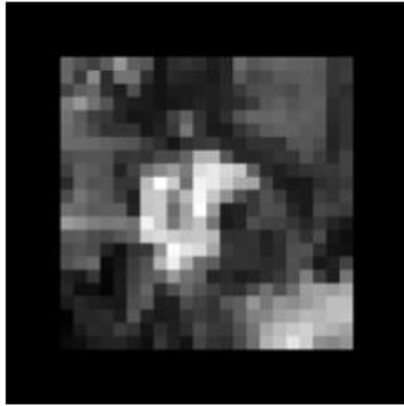

zero

wrap

clamp

mirror

Padded and
blurred image

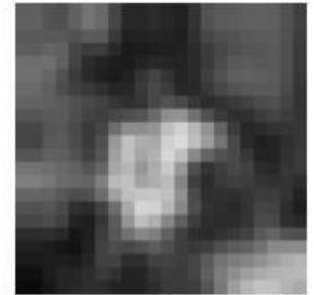
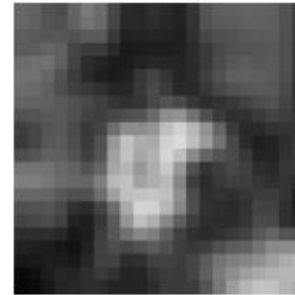
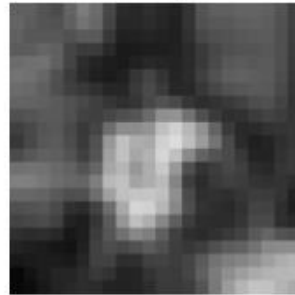
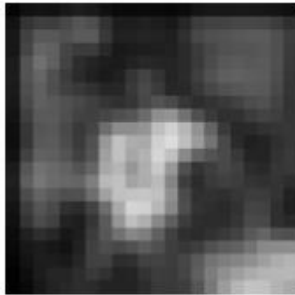

blurred: zero

normalized zero

clamp

mirror

What is the computational cost of the convolution?

$$g(i, j) = \sum_{k, l} f(i - k, j - l)h(k, l)$$

- ▶ How many multiplications do we need to do to convolve 100x100 image with 9x9 kernel ?
 - ▶ The image is padded, but we do not compute the values for the padded pixels

Separable kernels

- ▶ Convolution operation can be made much faster if split into two separate steps:
 - ▶ 1) convolve all rows in the image with a 1D filter
 - ▶ 2) convolve columns in the result of 1) with another 1D filter
- ▶ But to do this, the kernel must be separable

$$\begin{bmatrix} h_{11} & h_{12} & h_{13} \\ h_{21} & h_{22} & h_{23} \\ h_{31} & h_{32} & h_{33} \end{bmatrix} = \begin{bmatrix} u_1 \\ u_2 \\ u_3 \end{bmatrix} \cdot [v_1 \quad v_2 \quad v_3]$$

$$\vec{h} = \vec{u} \cdot \vec{v}$$

Examples of separable filters

▶ **Box filter:**

$$\begin{bmatrix} \frac{1}{9} & \frac{1}{9} & \frac{1}{9} \\ \frac{1}{9} & \frac{1}{9} & \frac{1}{9} \\ \frac{1}{9} & \frac{1}{9} & \frac{1}{9} \end{bmatrix} = \begin{bmatrix} \frac{1}{3} \\ \frac{1}{3} \\ \frac{1}{3} \end{bmatrix} \cdot \begin{bmatrix} \frac{1}{3} & \frac{1}{3} & \frac{1}{3} \end{bmatrix}$$

▶ **Gaussian filter:**

$$G(x, y; \sigma) = \frac{1}{2\pi\sigma^2} e^{-\frac{x^2+y^2}{2\sigma^2}}$$

▶ What are the corresponding 1D components of this separable filter ($u(x)$ and $v(y)$)?

$$G(x, y) = u(x) \times v(y)$$

Unsharp masking

- ▶ How to use blurring to sharpen an image ?

results



original image



high-pass image



blurry image

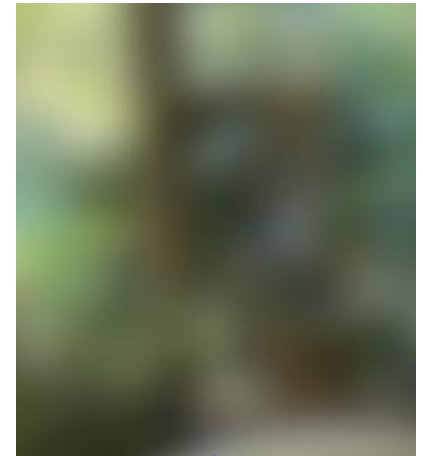

$$g_{\text{sharp}} = f + \gamma(f - h_{\text{blur}} * f)$$

Diagram showing arrows from the images above pointing to the equation. The original image points to f . The high-pass image points to $f - h_{\text{blur}} * f$. The blurry image points to $h_{\text{blur}} * f$. The result image points to g_{sharp} .

Why “linear” filters ?

- ▶ Linear functions have two properties:
 - ▶ Additivity: $f(x) + f(y) = f(x + y)$
 - ▶ Homogeneity: $f(ax) = af(x)$ (where “ f ” is a linear function)
- ▶ Why is it important?
 - ▶ Linear operations can be performed in an arbitrary order
$$\text{blur}(aF + b) = a \text{blur}(F) + b$$
 - ▶ Linearity of the Gaussian filter could be used to improve the performance of your image processing operation
 - ▶ This is also how the separable filters work:

Matrix multiplication

Convolution

The components
of a separable
kernel

$$(u \cdot v) * f = u * (v * f)$$

An image

Operations on binary images

- ▶ Essential for many computer vision tasks



- ▶ Binary image can be constructed by thresholding a grayscale image

$$\theta(f, c) = \begin{cases} 1 & \text{if } f \geq c, \\ 0 & \text{else,} \end{cases}$$

Morphological filters: dilation

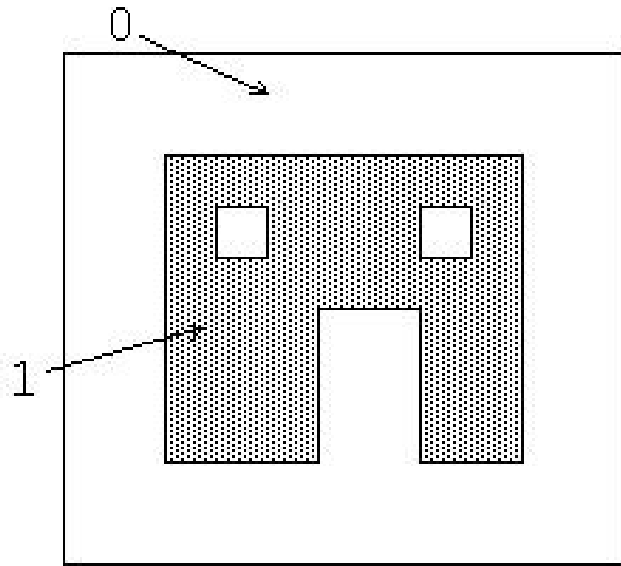

a) Original image

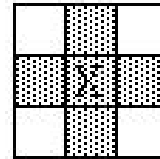

b) Structuring element;
x = origin

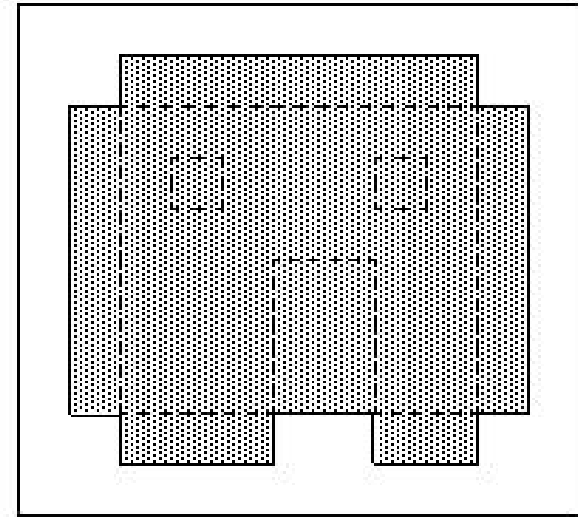

c) Image after dilation;
original in dashes

- ▶ Set the pixel to the maximum value of the neighboring pixels within the structuring element
- ▶ What could it be useful for ?

Morphological filters: erosion

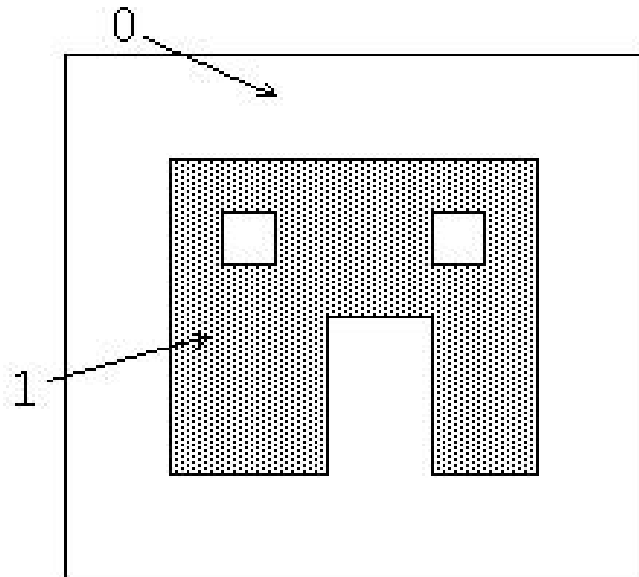

a) Original image

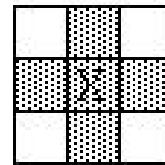

b) Structuring element;
x = origin

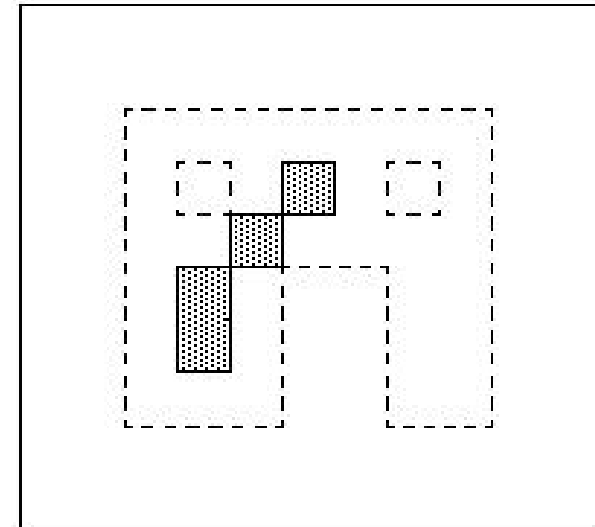

c) Image after erosion;
original in dashes

- ▶ Set the value to the minimum value of all the neighboring pixels within the structuring element
- ▶ What could it be useful for ?

Morphological filters: opening

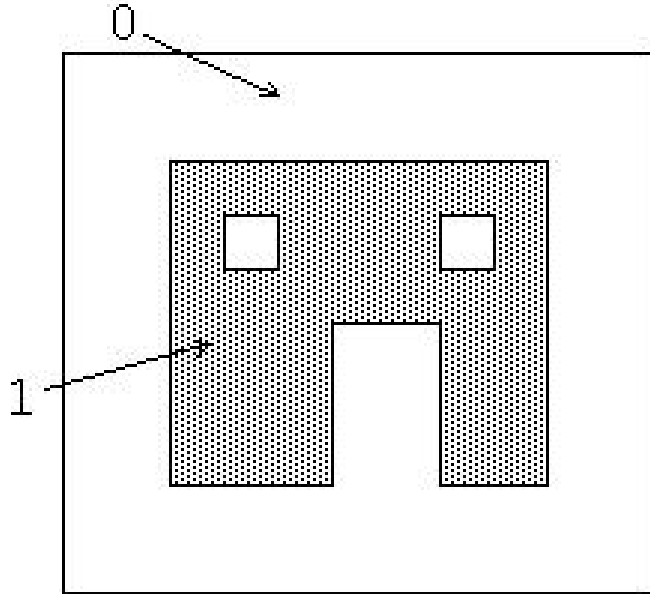

a) Original image

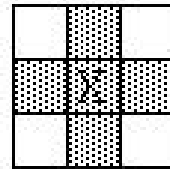

b) Structuring element;
x = origin

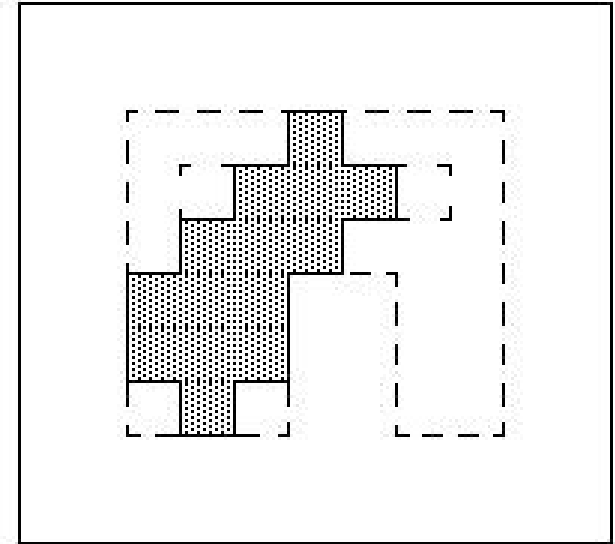

c) Image after opening =
erosion followed by
dilation

- ▶ Erosion followed by dilation
- ▶ What could it be useful for?

Morphological filters: closing

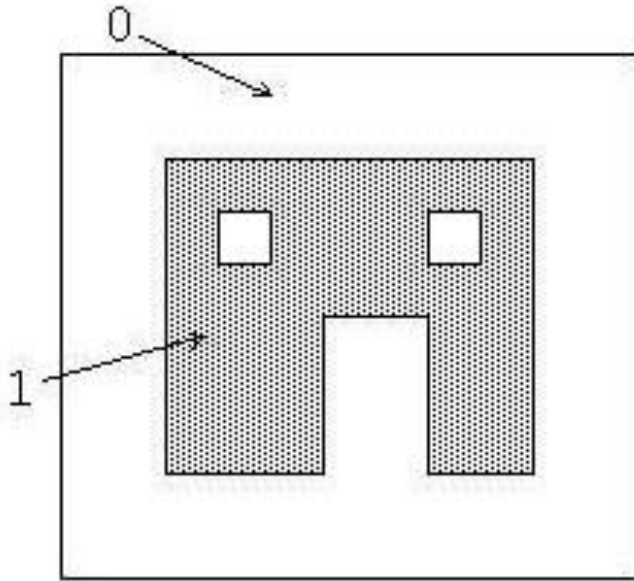

a) Original image

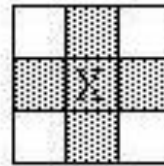

b) Structuring element;
x = origin

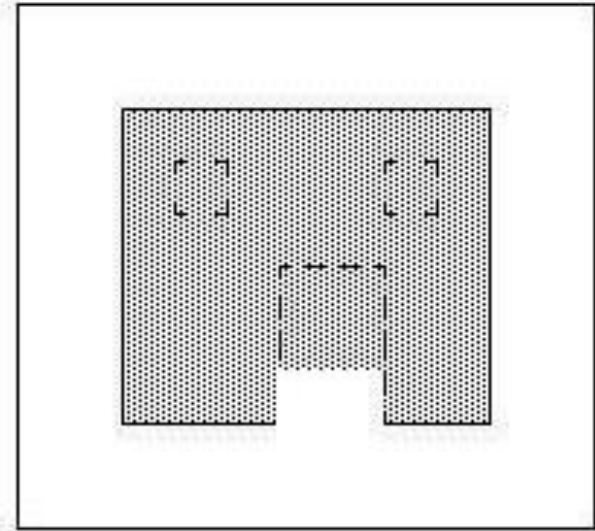

c) Image after closing =
dilation followed by
erosion; original in
dashes.

- ▶ Dilation followed by erosion
- ▶ What could it be useful for ?

Binary morphological filters: formal definition

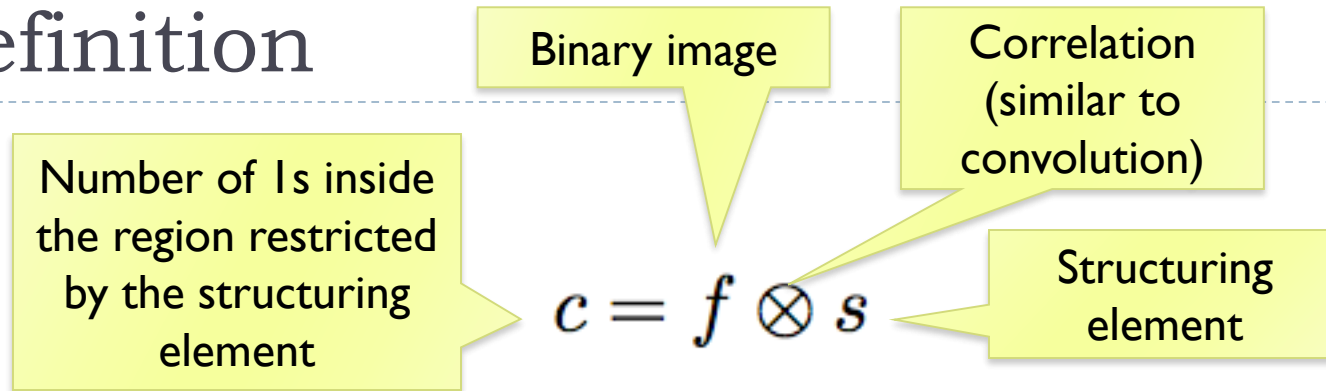

S – size of structuring element (number of 1s in the SI)

• **dilation:** $\text{dilate}(f, s) = q(c, 1)$;

• **erosion:** $\text{erode}(f, s) = \theta(c, S)$;

• **majority:** $\text{maj}(f, s) = \theta(c, S/2)$;

• **opening:** $\text{open}(f, s) = \text{dilate}(\text{erode}(f, s), s)$;

• **closing:** $\text{close}(f, s) = \text{erode}(\text{dilate}(f, s), s)$.

$$\theta(f, c) = \begin{cases} 1 & \text{if } f \geq c, \\ 0 & \text{else,} \end{cases}$$

Multi-scale image processing (pyramids)

- ▶ Multi-scale processing operates on an image represented at several sizes (scales)
 - ▶ Fine level for operating on small details
 - ▶ Coarse level for operating on large features
- ▶ **Example:**
 - ▶ Motion estimation
 - ▶ Use fine scales for objects moving slowly
 - ▶ Use coarse scale for objects moving fast
 - ▶ Blending (to avoid sharp boundaries)

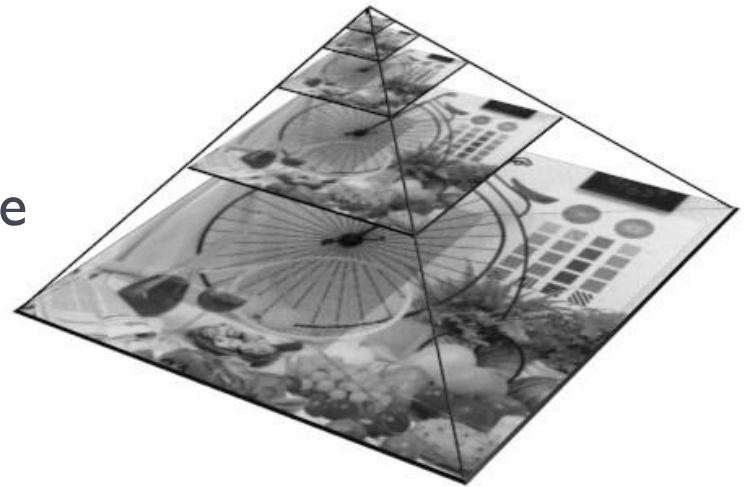

Two types of pyramids

Gaussian pyramid

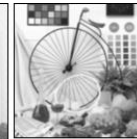

Level 4

Level 3

Level 2

Level 1

Laplacian pyramid

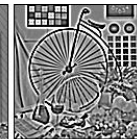
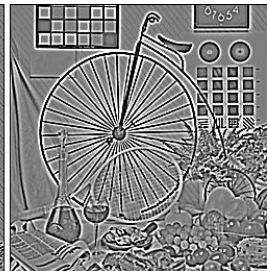
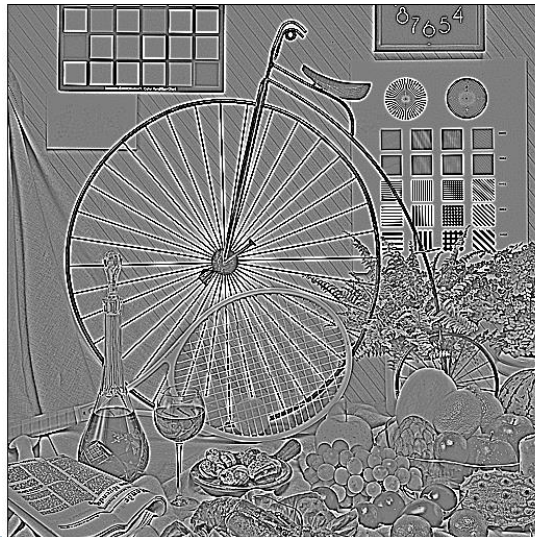

Level 4 (base band)

Level 3

Level 2

Level 1

(a.k.a DoG
Diffence of
Gaussians)

BURT, P. AND ADELSON, E. 1983. The Laplacian Pyramid as a Compact Image Code. *IEEE Transactions on Communications* 31, 4, 532–540.



Gaussian Pyramid

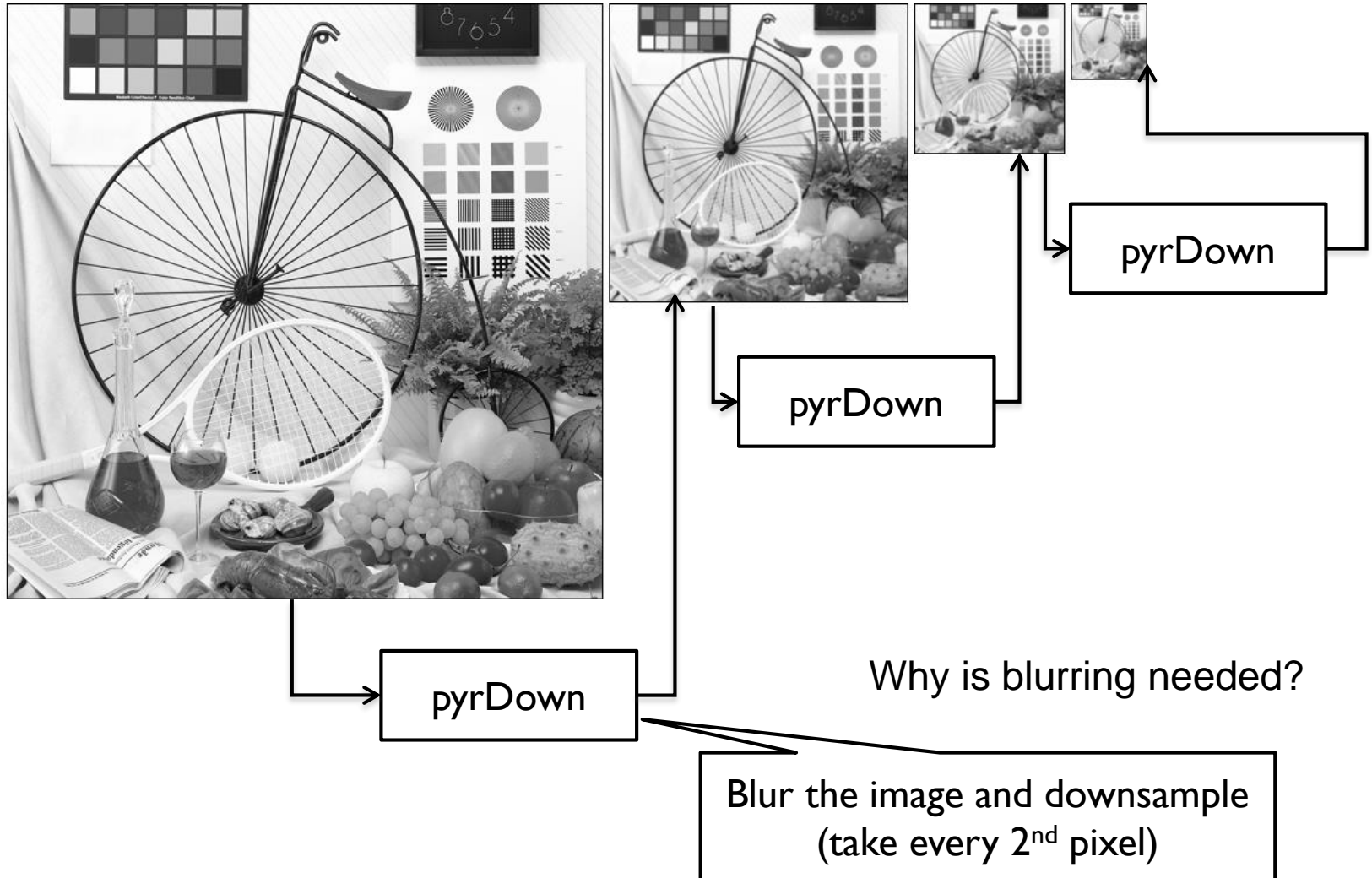

Laplacian Pyramid - decomposition

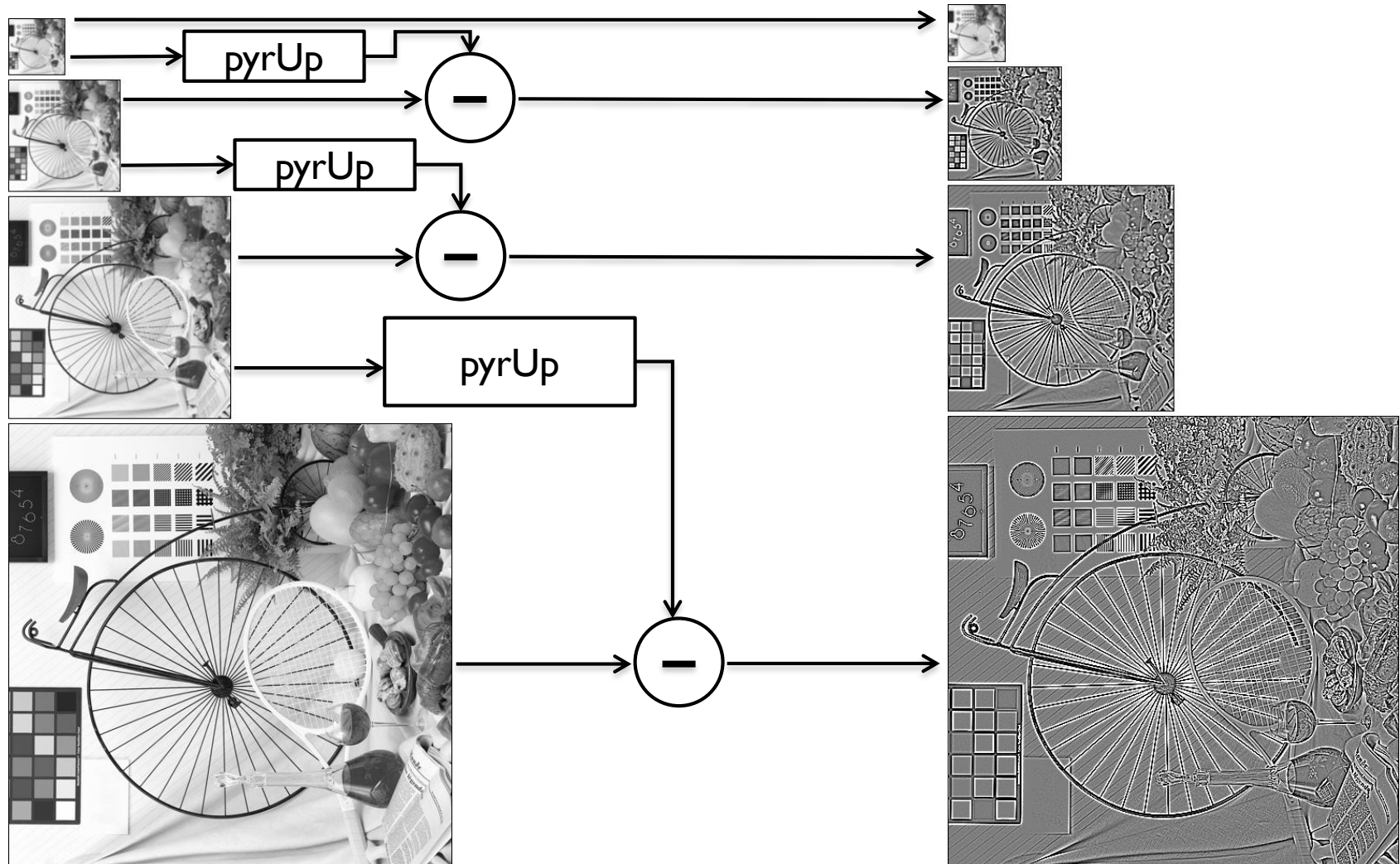

Laplacian Pyramid - synthesis

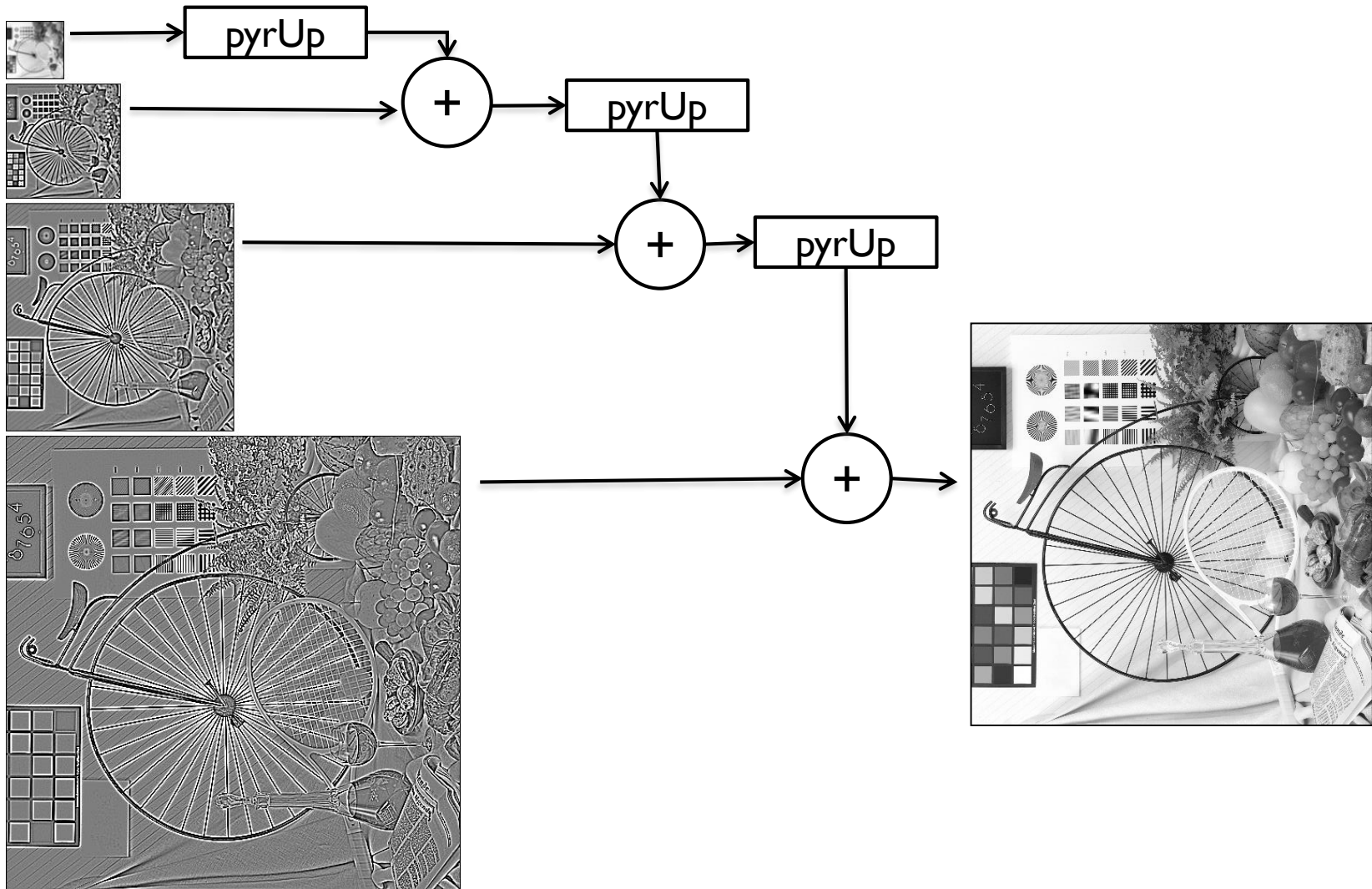

Example: stitching and blending

Combine two images:



+



Image-space
blending



Laplacian pyramid
blending



References

- ▶ SZELISKI, R. 2010. *Computer Vision: Algorithms and Applications*. Springer-Verlag New York Inc.
 - ▶ Chapter 3
 - ▶ <http://szeliski.org/Book>