

Red-Black Tree Example

James Clarke

University of Cambridge

February 7, 2015

Inserting 'A'

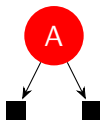

Inserting 'A'

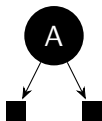

Inserting 'L'

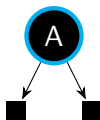

Inserting 'L'

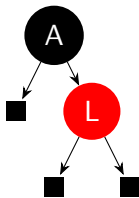

Inserting 'G'

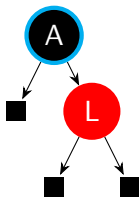

Inserting 'G'

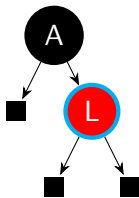

Inserting 'G'

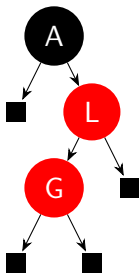

Inserting 'G'

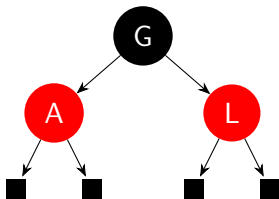

Inserting 'O'

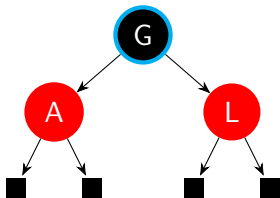

Inserting 'O'

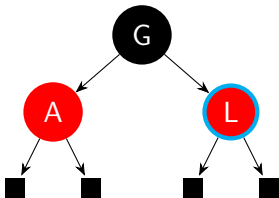

Inserting 'O'

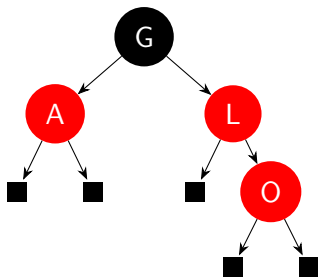

Inserting 'O'

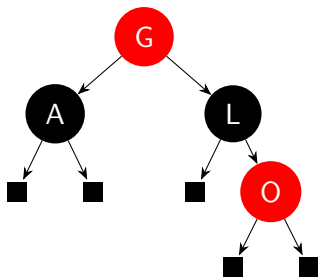

Inserting 'O'

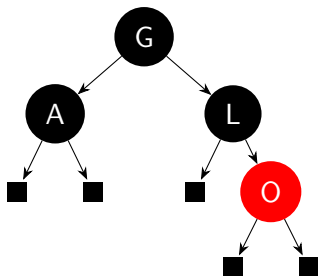

Inserting 'R'

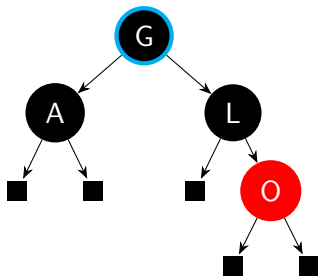

Inserting 'R'

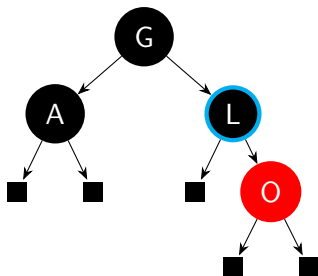

Inserting 'R'

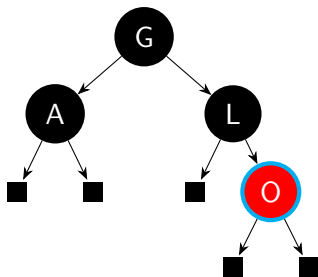

Inserting 'R'

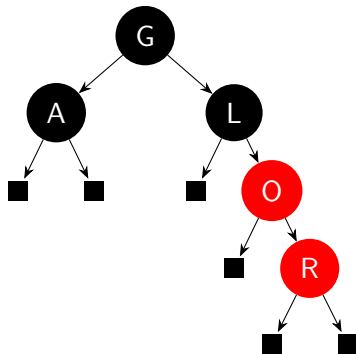

Inserting 'R'

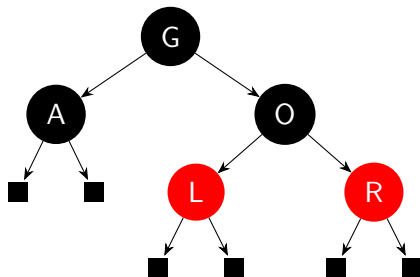

Inserting 'l'

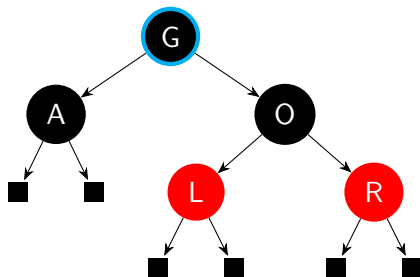

Inserting 'l'

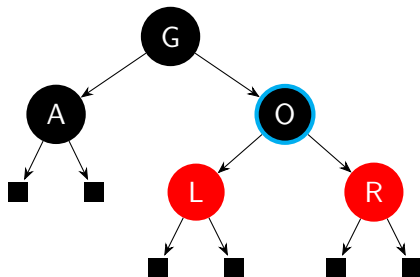

Inserting 'l'

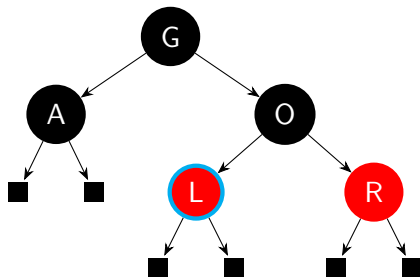

Inserting 'I'

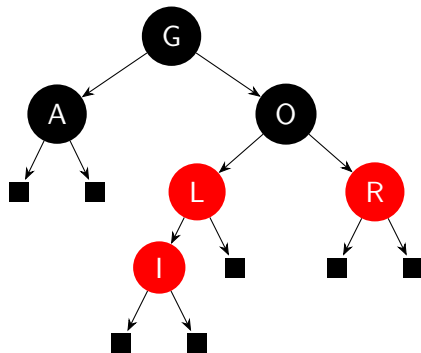

Inserting 'I'

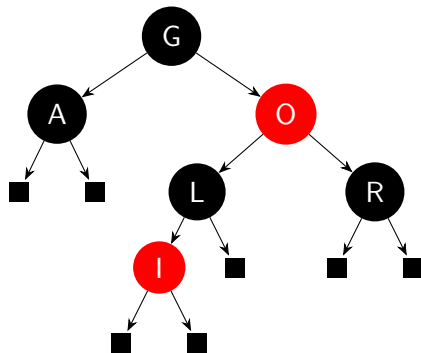

Inserting 'T'

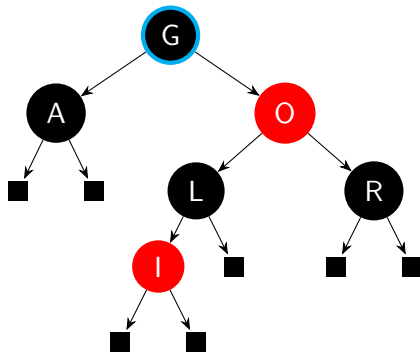

Inserting 'T'

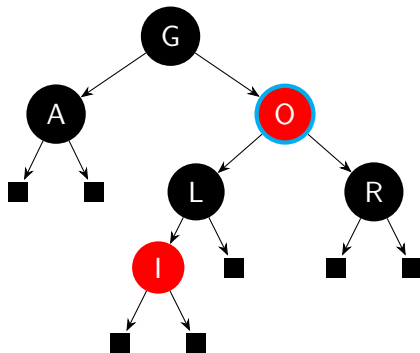

Inserting 'T'

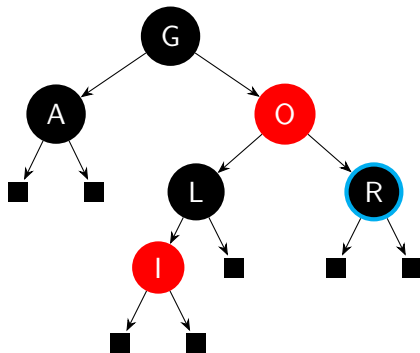

Inserting 'T'

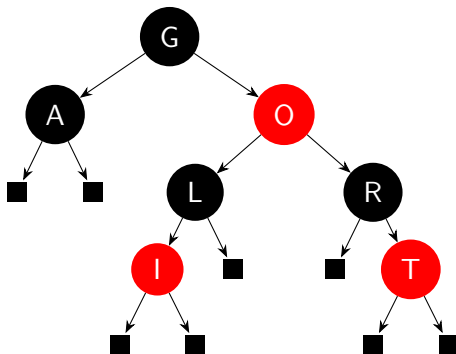

Inserting 'H'

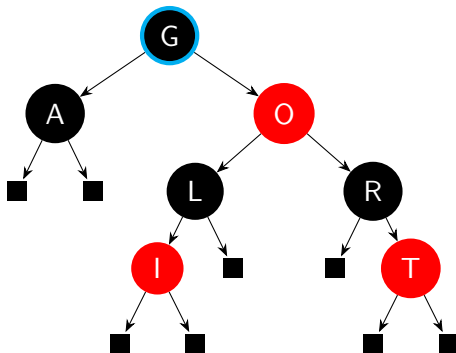

Inserting 'H'

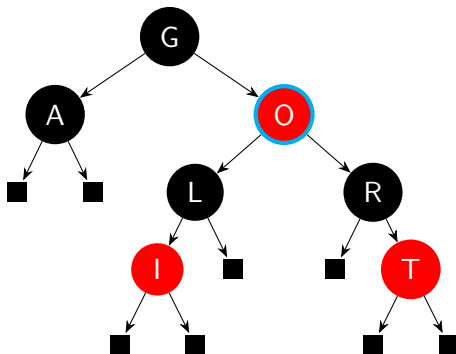

Inserting 'H'

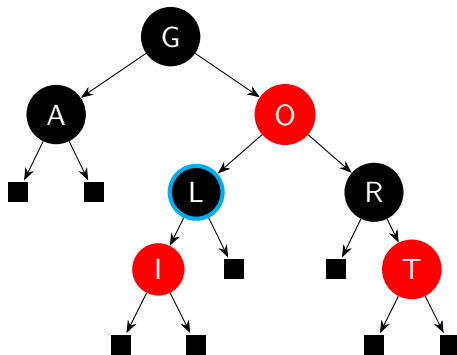

Inserting 'H'

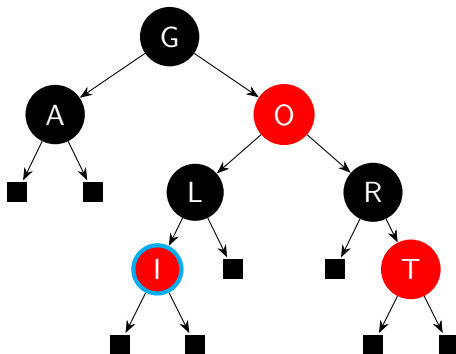

Inserting 'H'

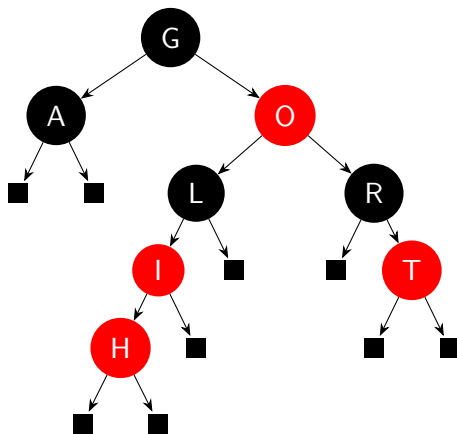

Inserting 'H'

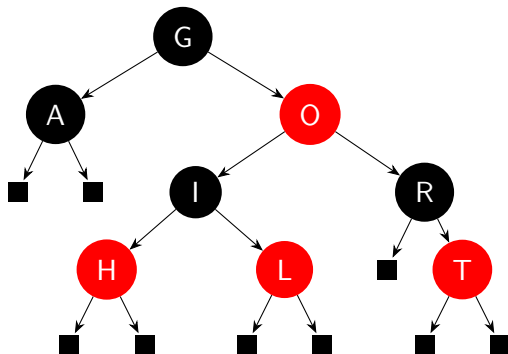

Inserting 'M'

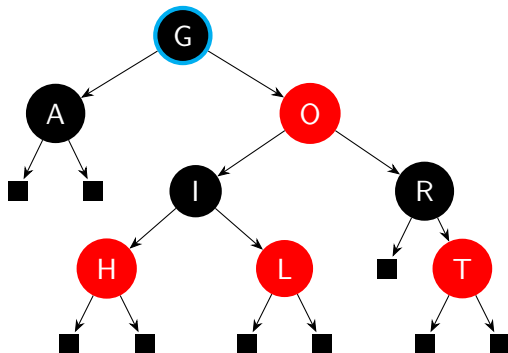

Inserting 'M'

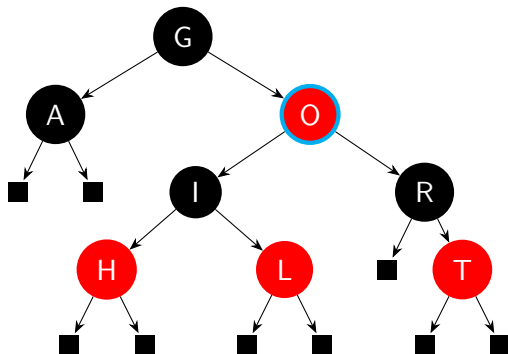

Inserting 'M'

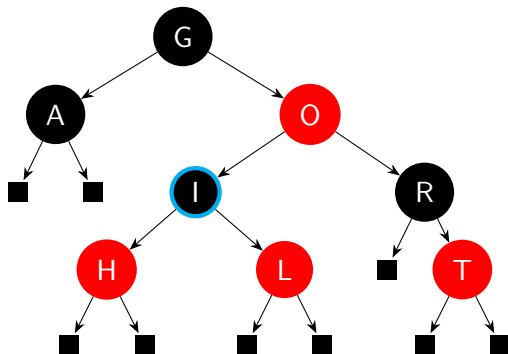

Inserting 'M'

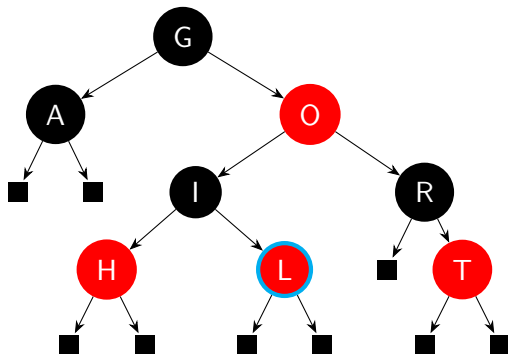

Inserting 'M'

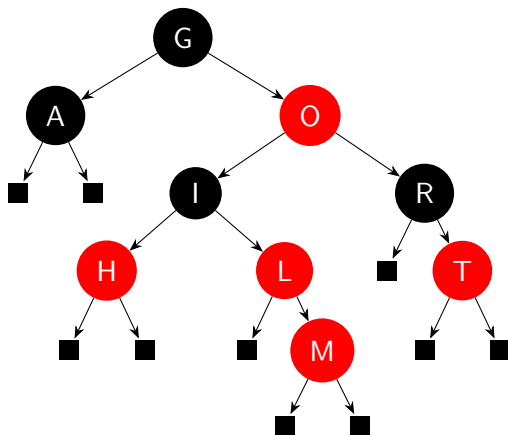

Inserting 'M'

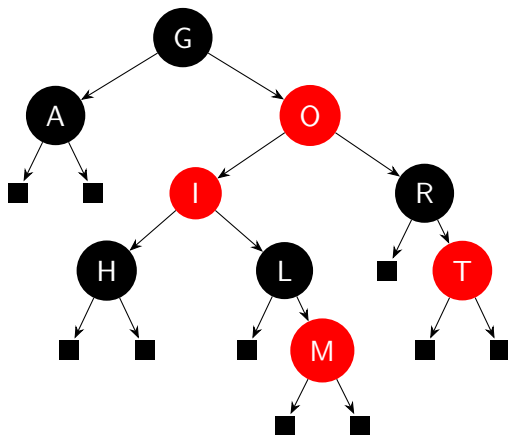

Inserting 'S'

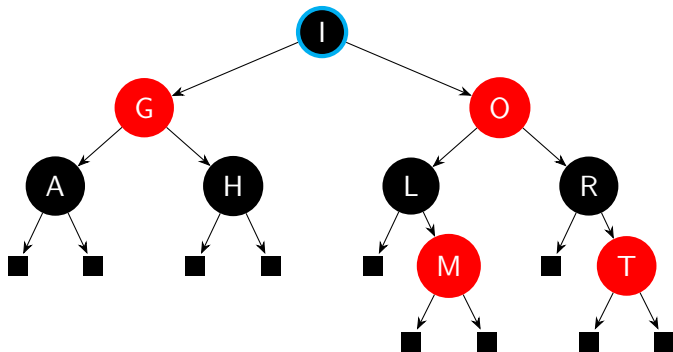

Inserting 'S'

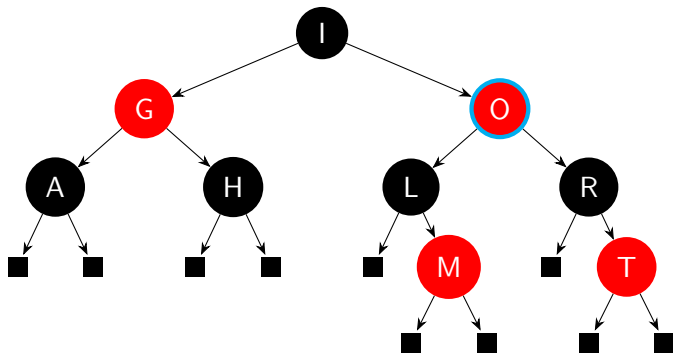

Inserting 'S'

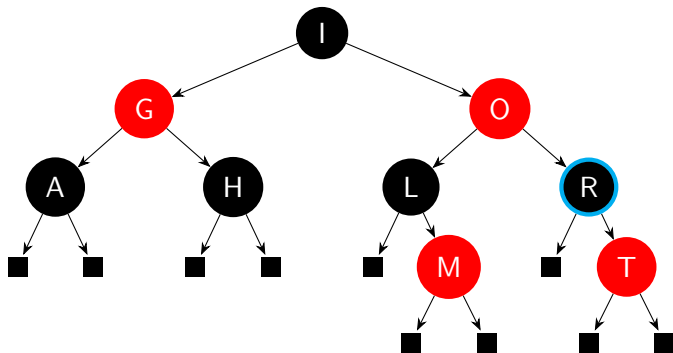

Inserting 'S'

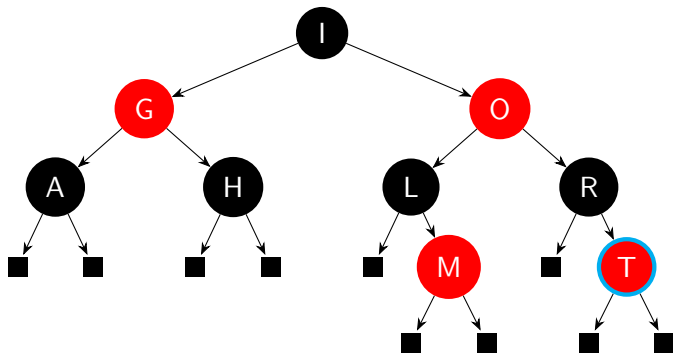

Inserting 'S'

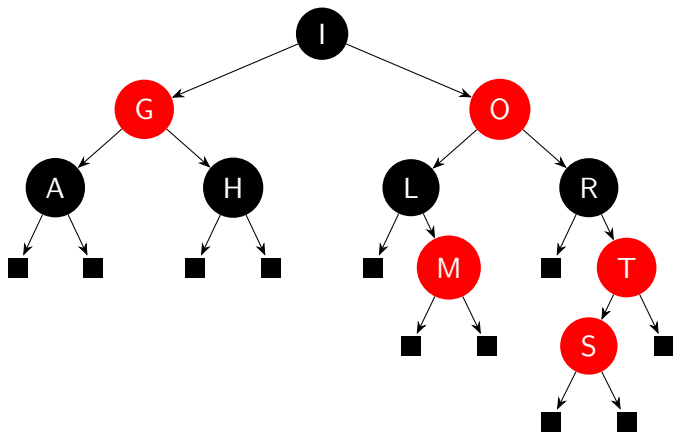

Inserting 'S'

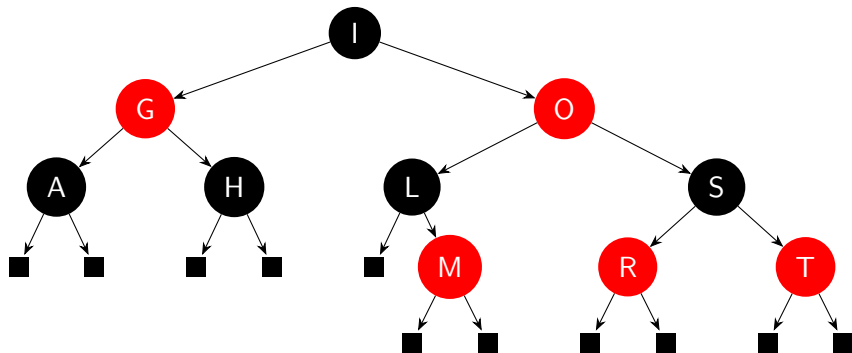

Inserting 'C'

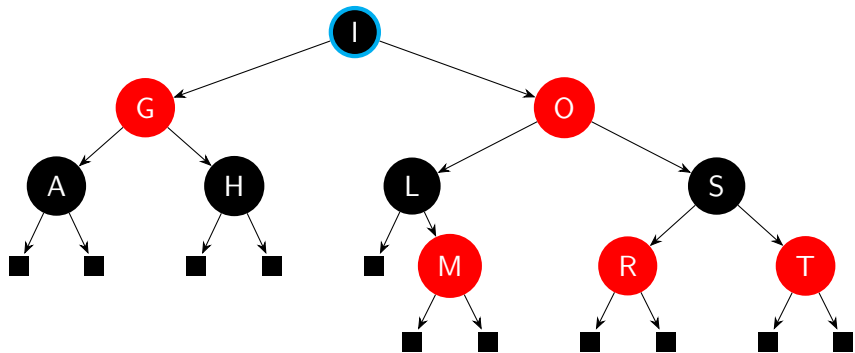

Inserting 'C'

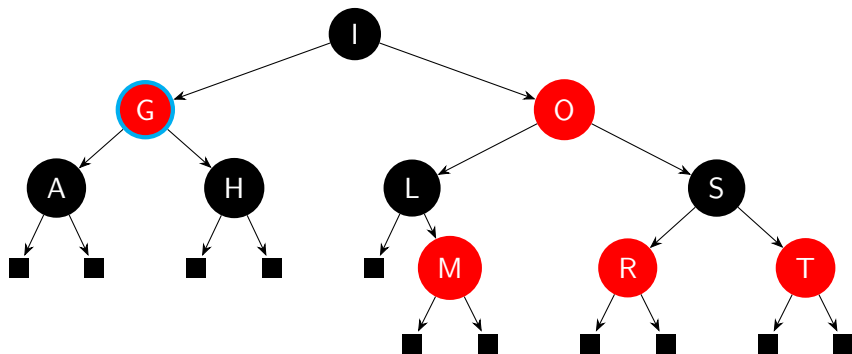

Inserting 'C'

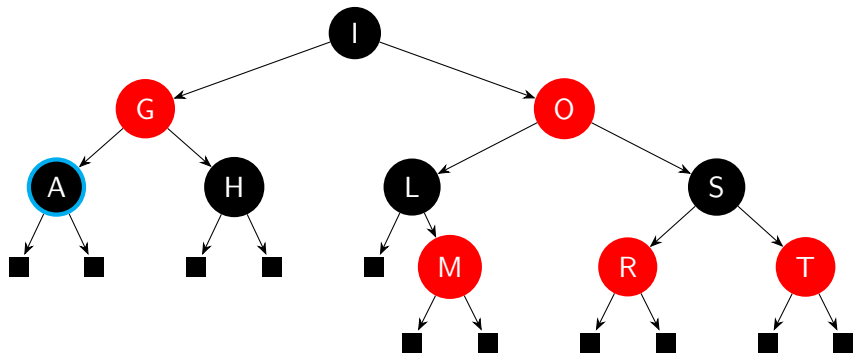

Inserting 'C'

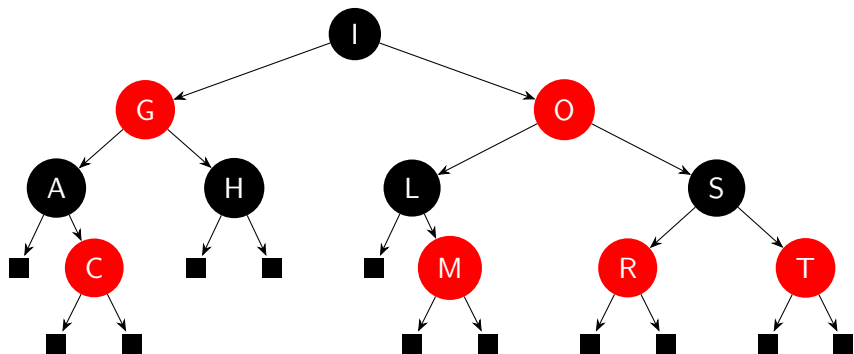

Inserting 'A'

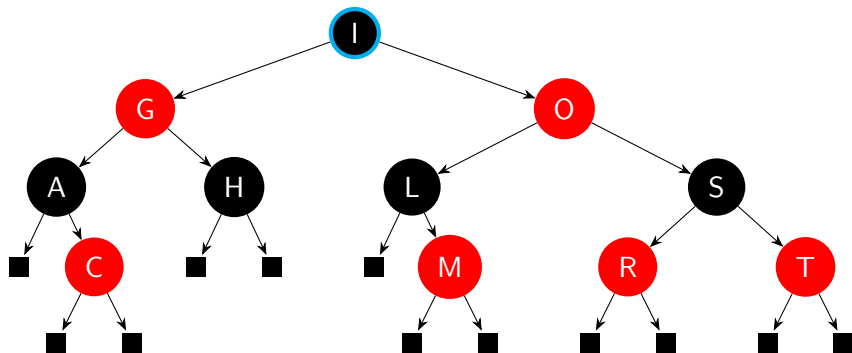

Inserting 'A'

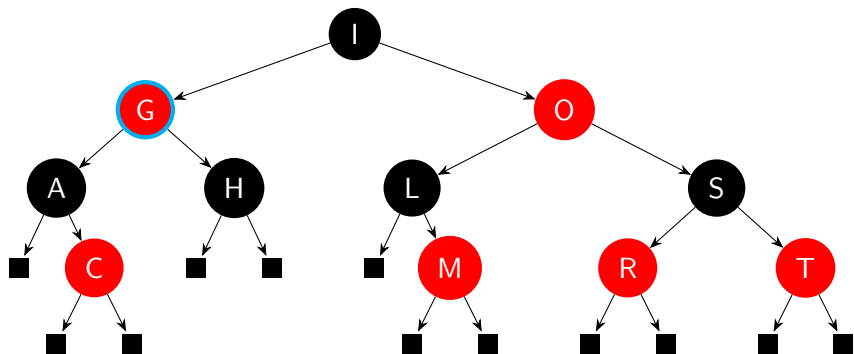

Inserting 'A'

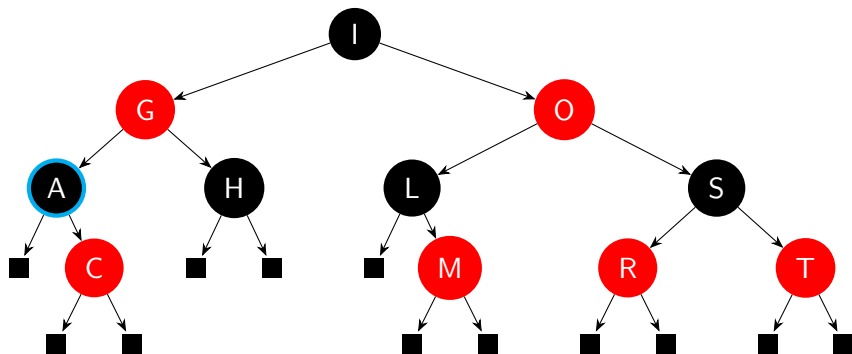

Inserting 'A'

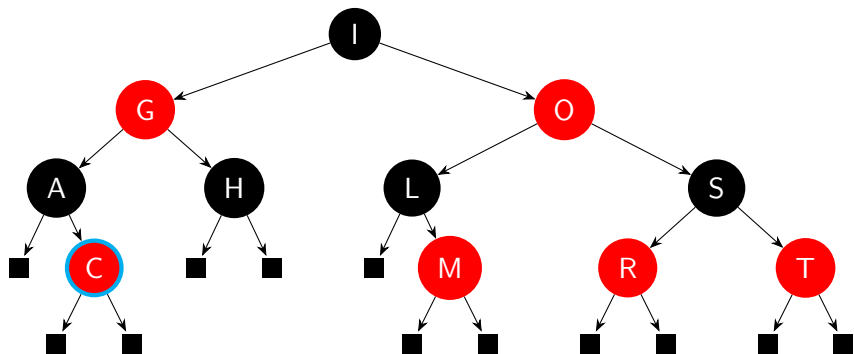

Inserting 'A'

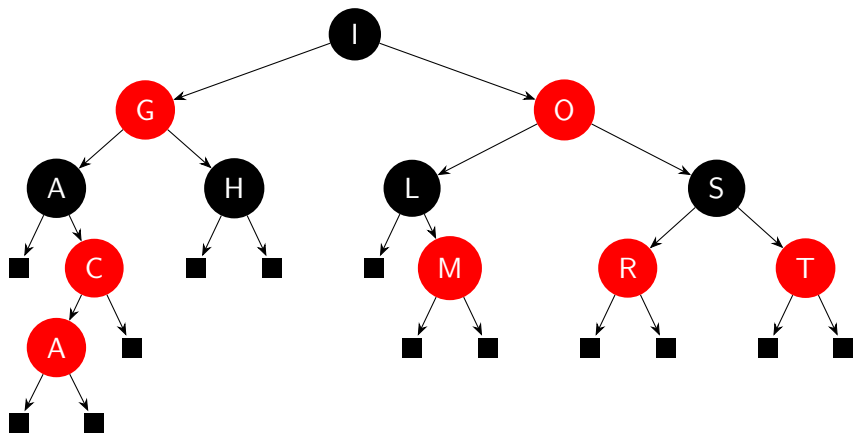

Inserting 'A'

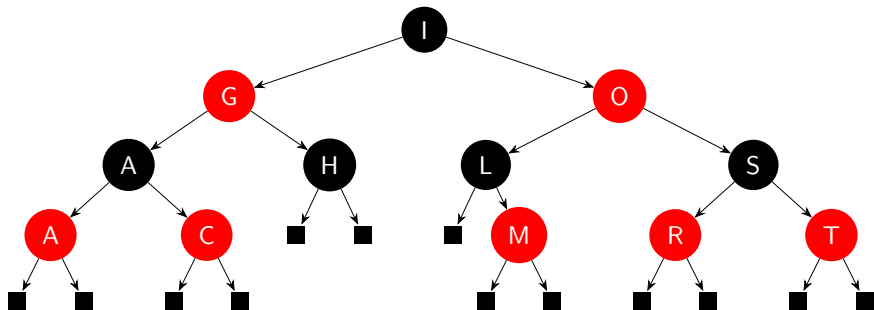

Inserting 'M'

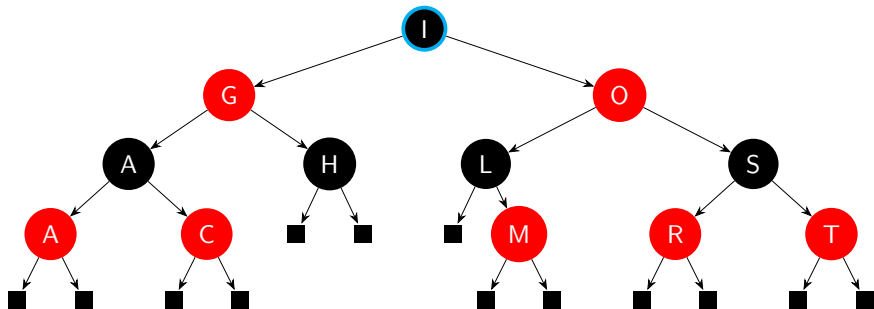

Inserting 'M'

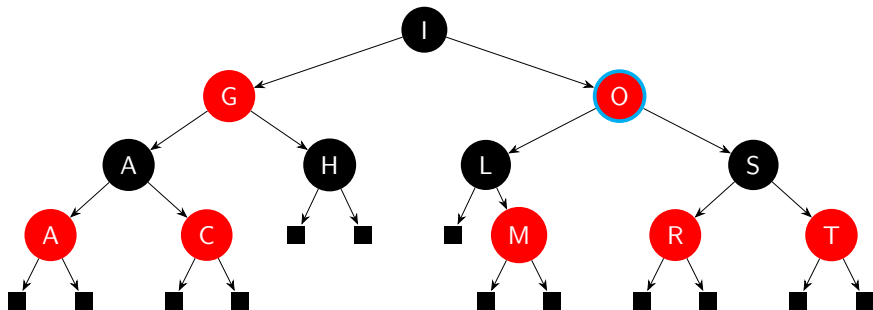

Inserting 'M'

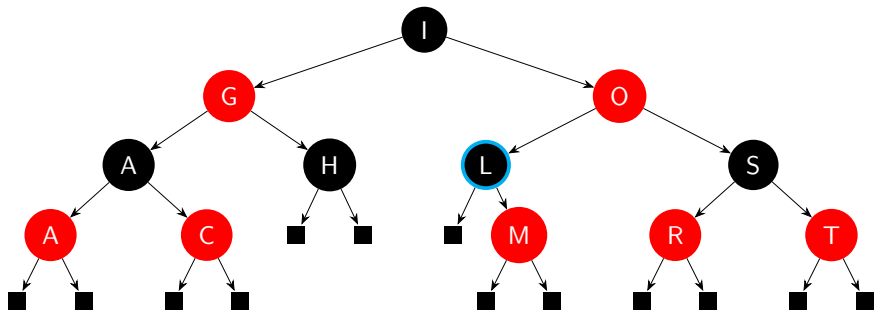

Inserting 'M'

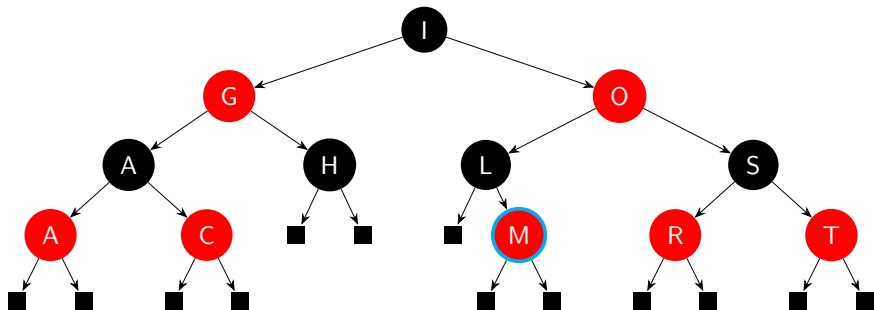

Inserting 'M'

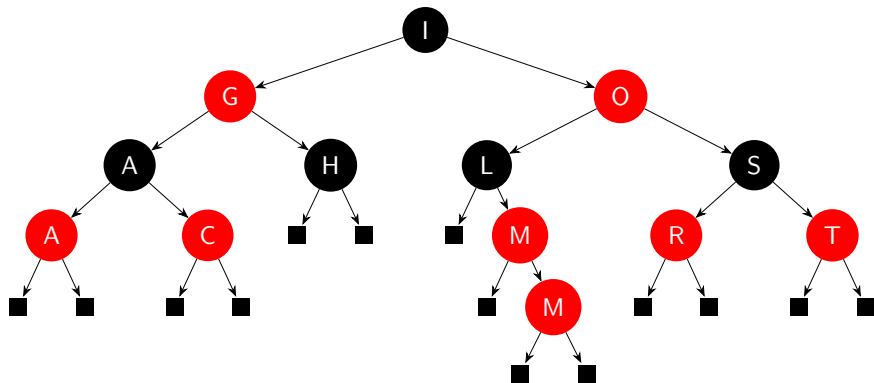

Inserting 'M'

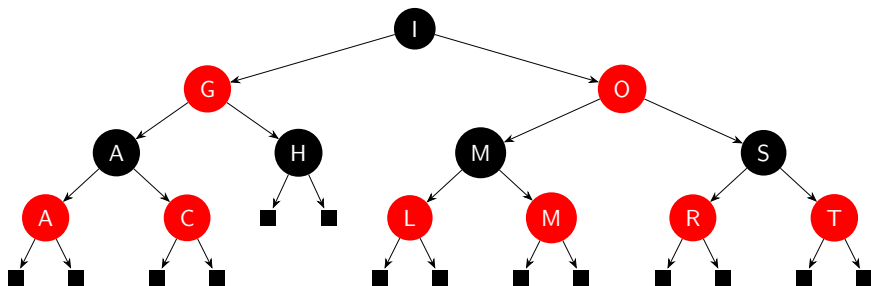

Inserting 'B'

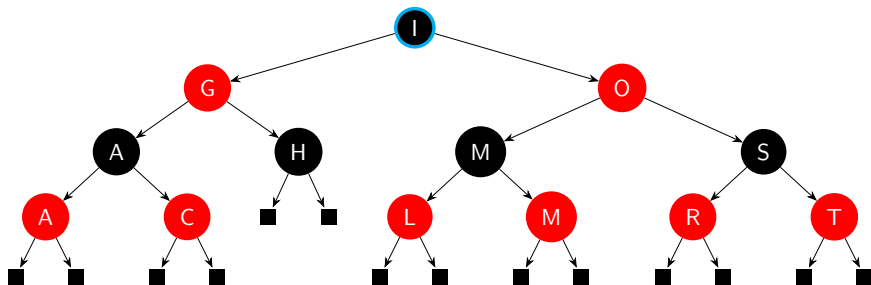

Inserting 'B'

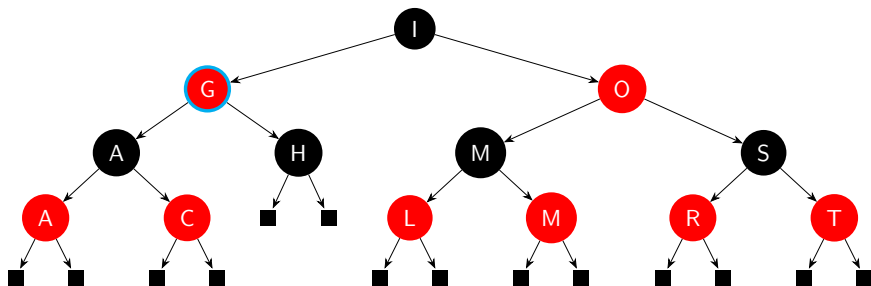

Inserting 'B'

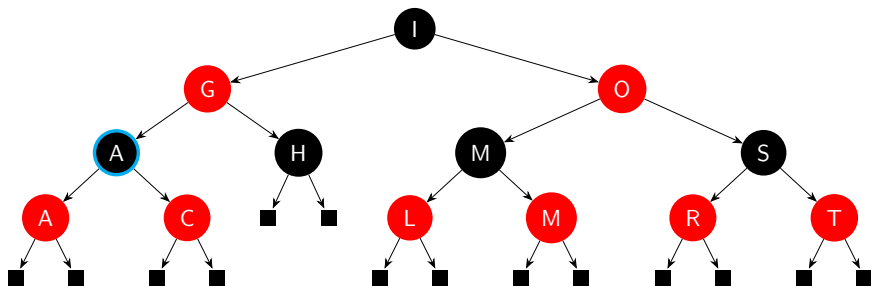

Inserting 'B'

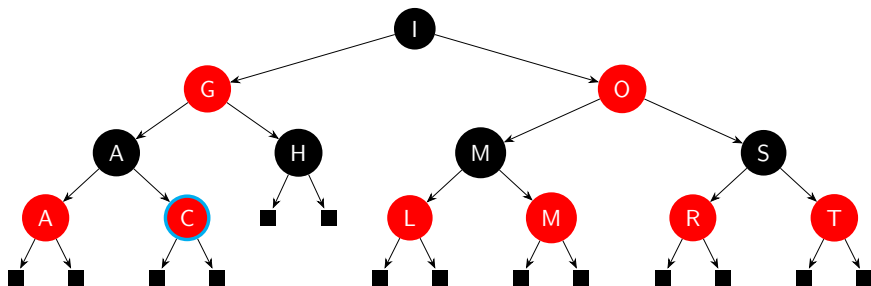

Inserting 'B'

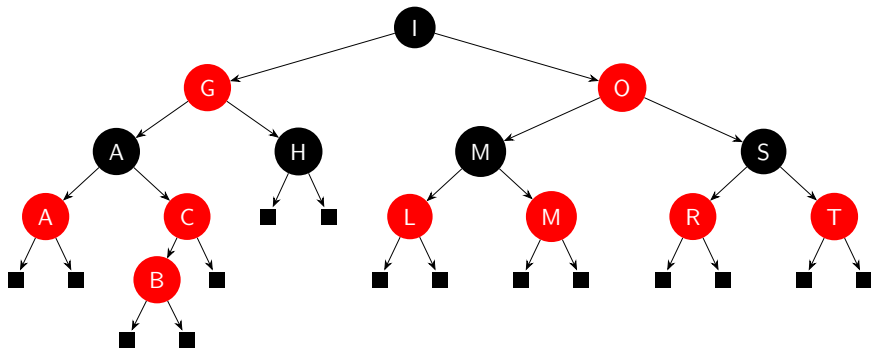

Inserting 'B'

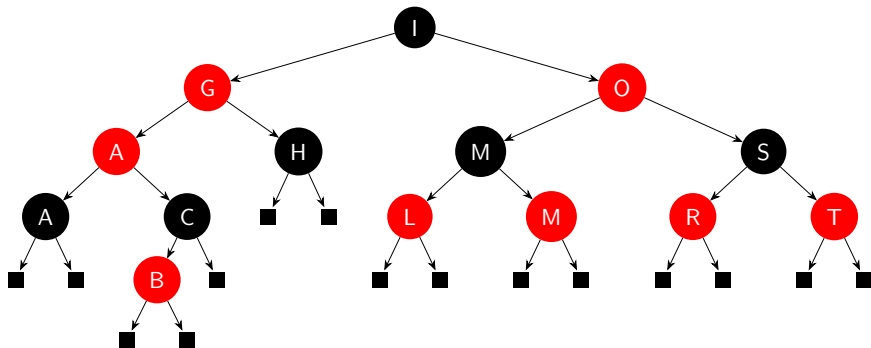

Inserting 'B'

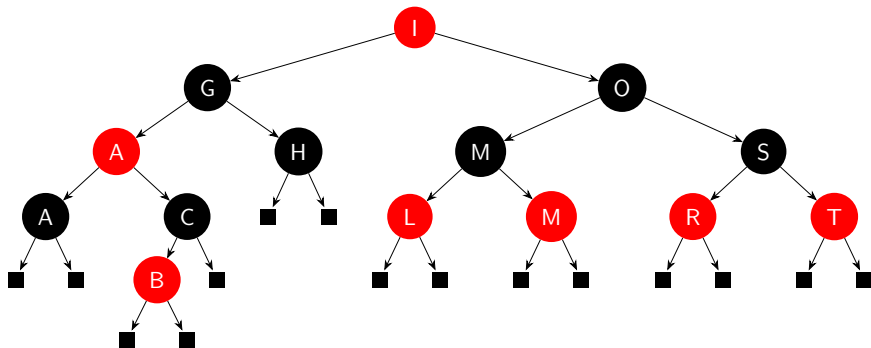

Inserting 'B'

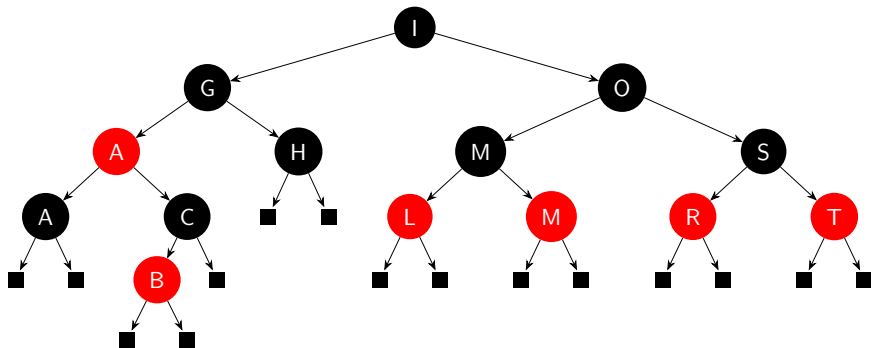

Inserting 'R'

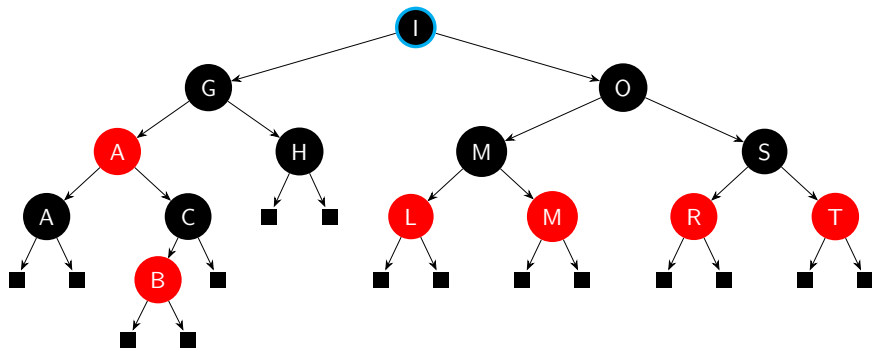

Inserting 'R'

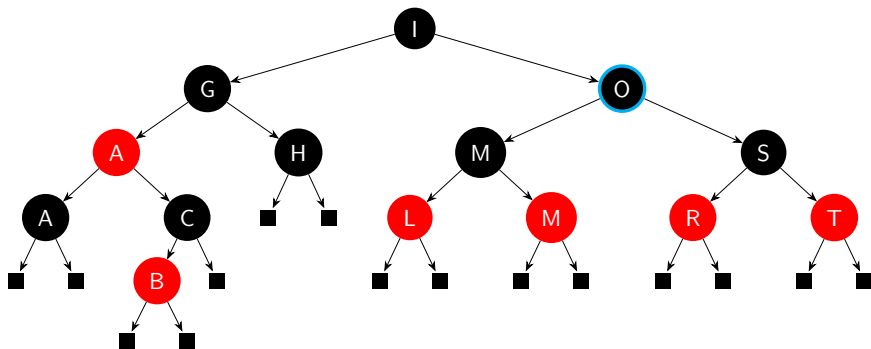

Inserting 'R'

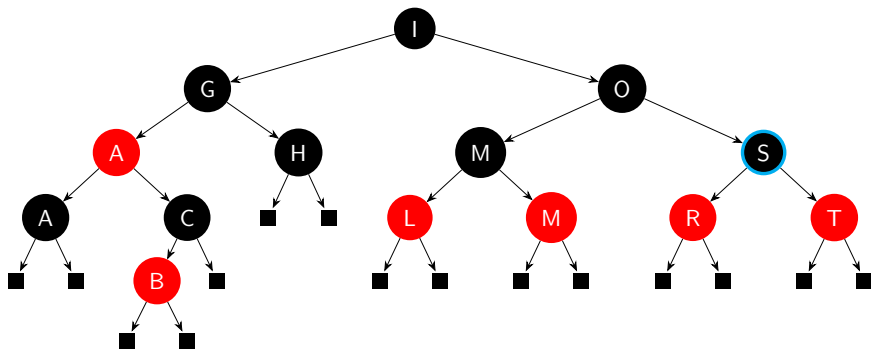

Inserting 'R'

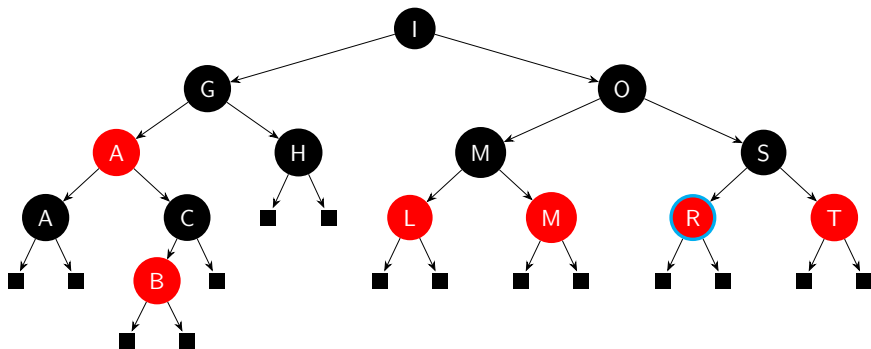

Inserting 'R'

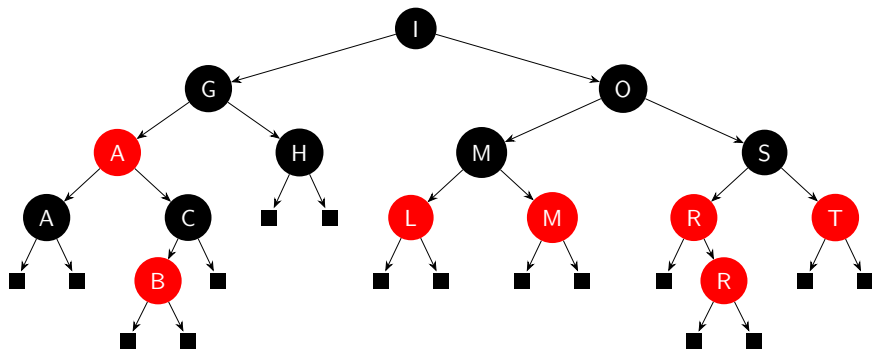

Inserting 'R'

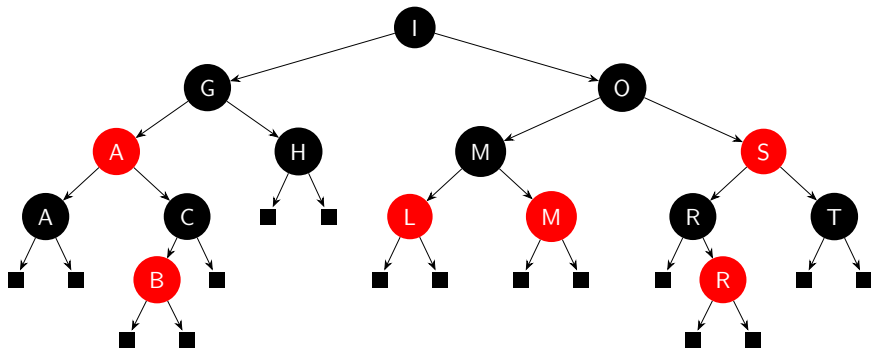

Inserting 'I'

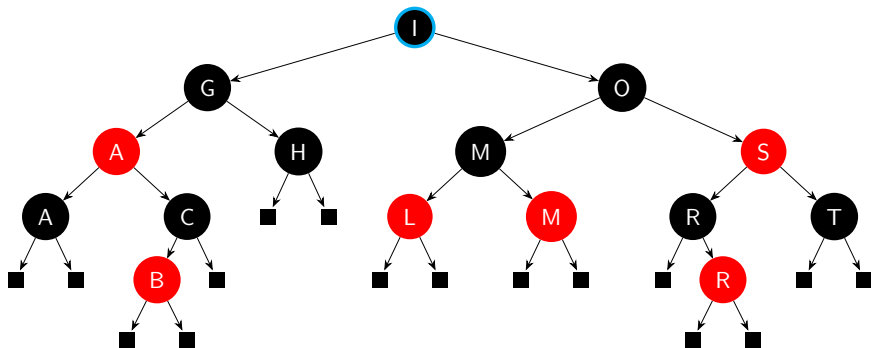

Inserting 'l'

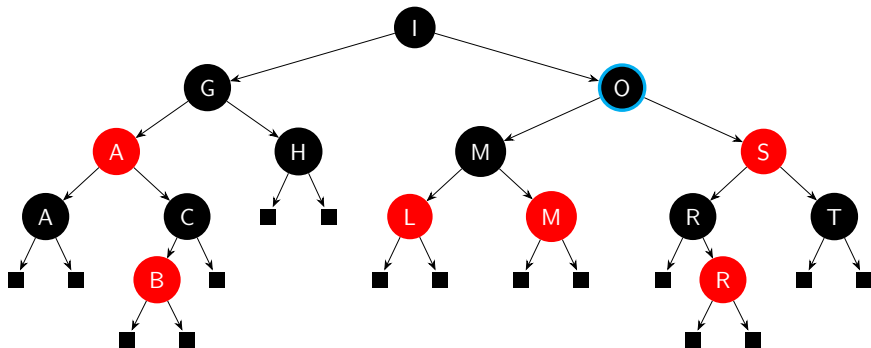

Inserting 'l'

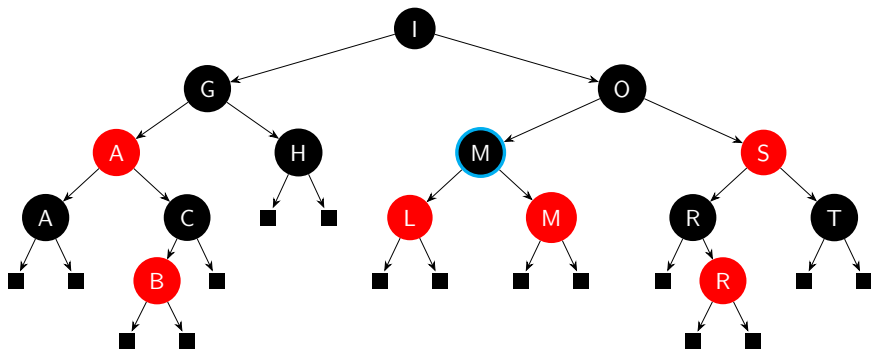

Inserting 'l'

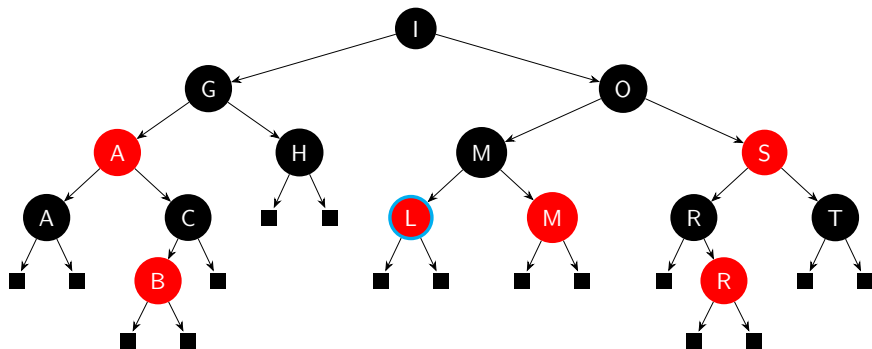

Inserting 'I'

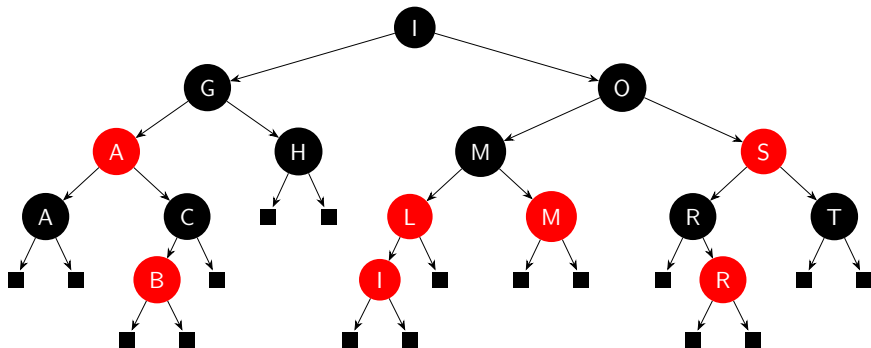

Inserting 'I'

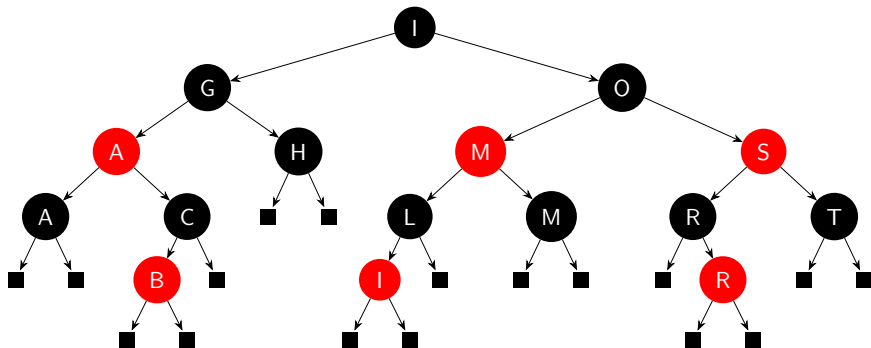

Inserting 'D'

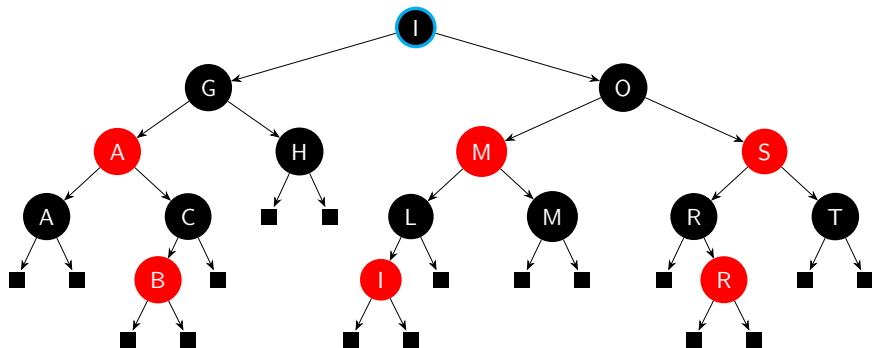

Inserting 'D'

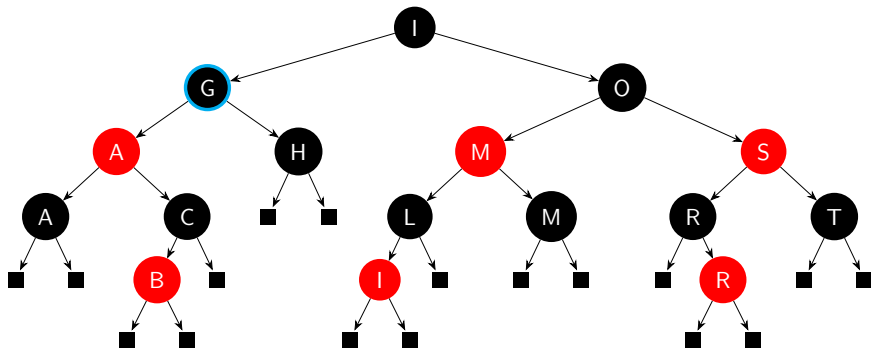

Inserting 'D'

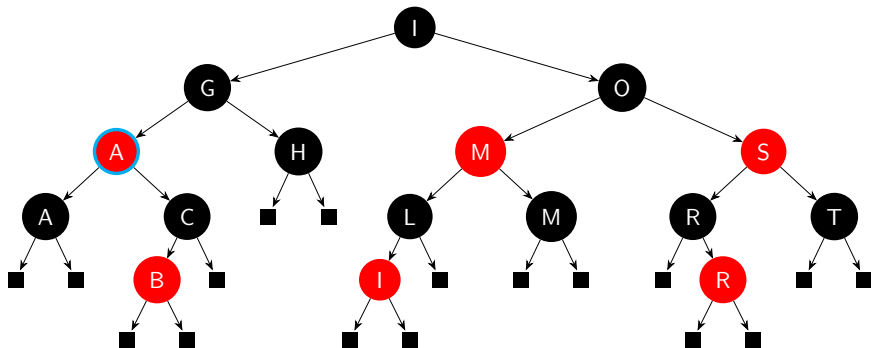

Inserting 'D'

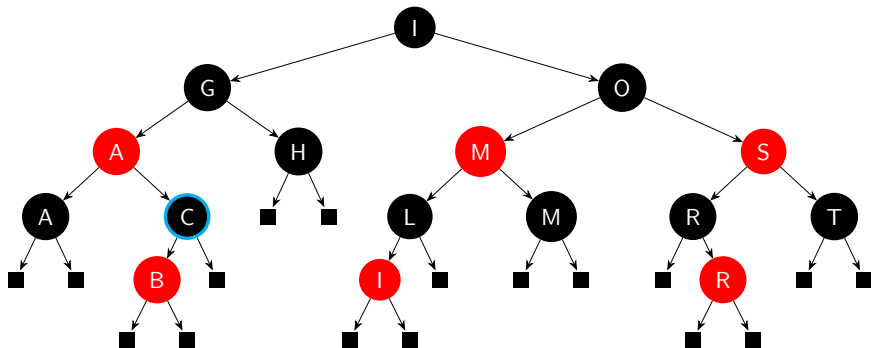

Inserting 'D'

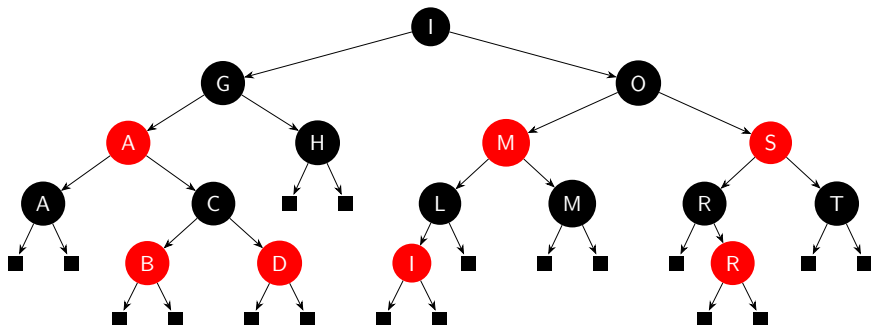

Inserting 'G'

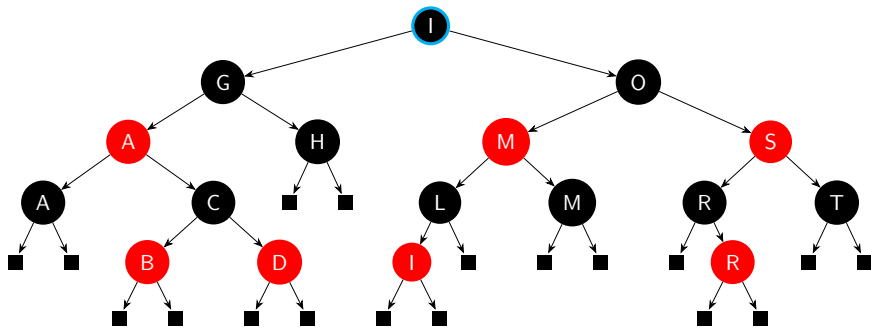

Inserting 'G'

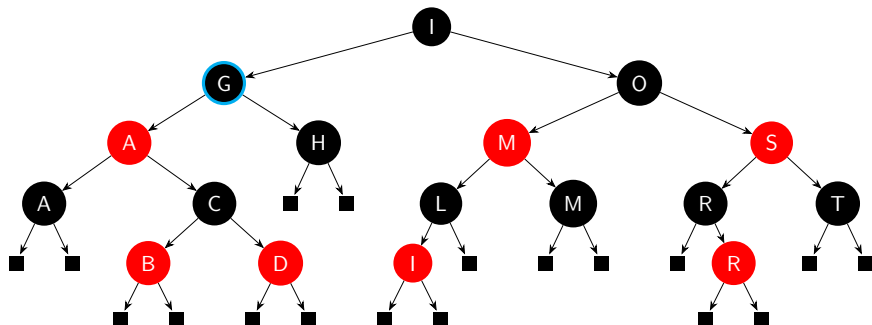

Inserting 'G'

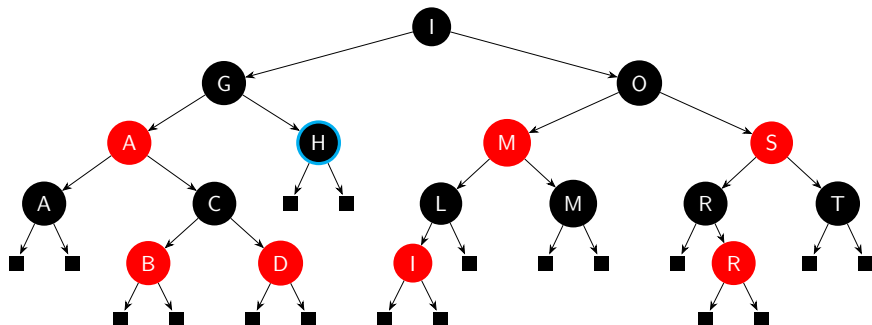

Inserting 'G'

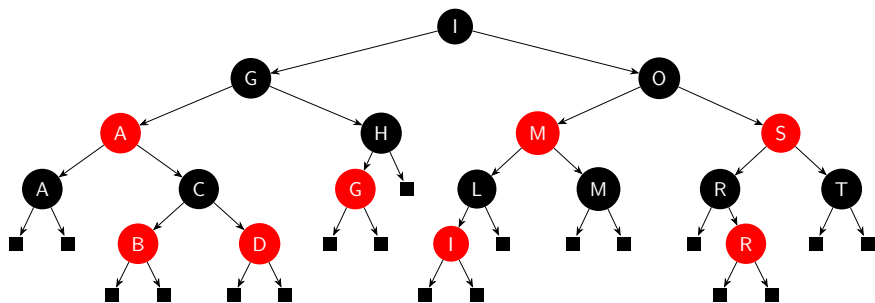

Inserting 'E'

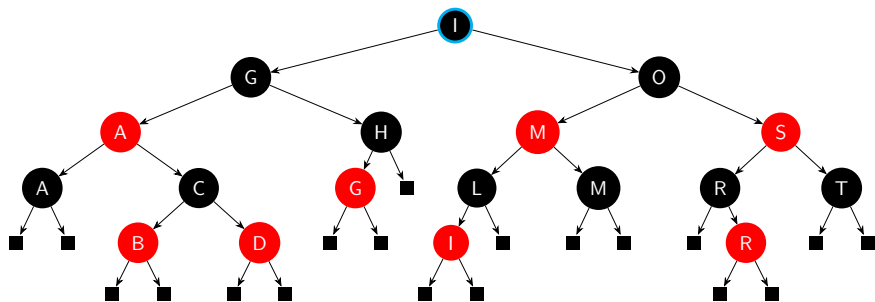

Inserting 'E'

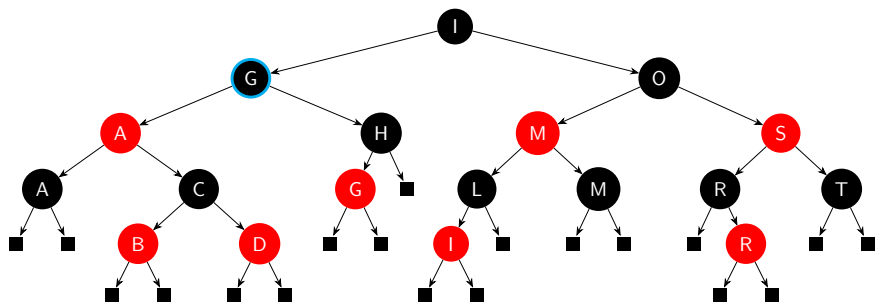

Inserting 'E'

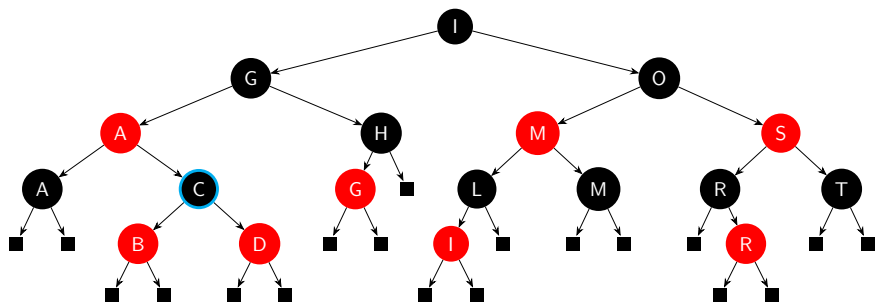

Inserting 'E'

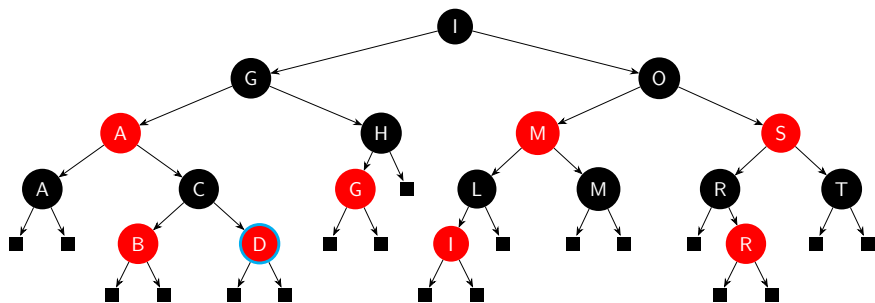

Inserting 'E'

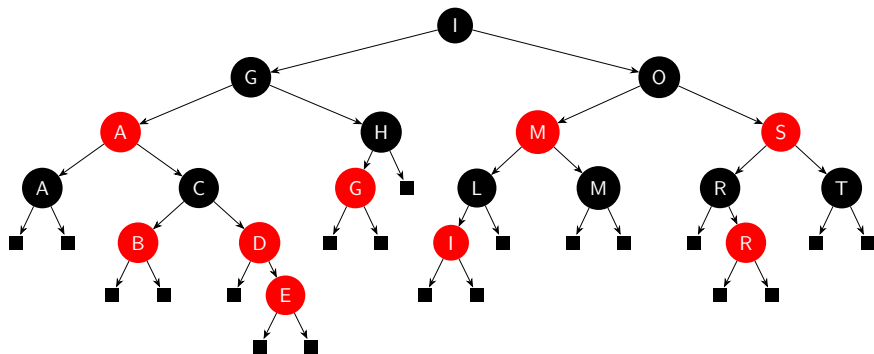

Inserting 'E'

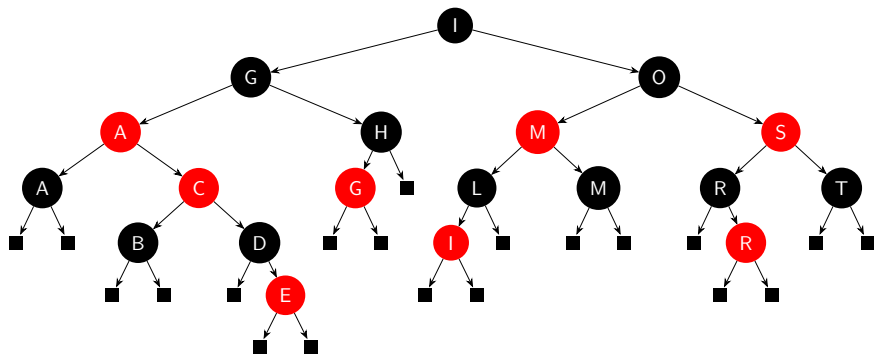

Inserting 'E'

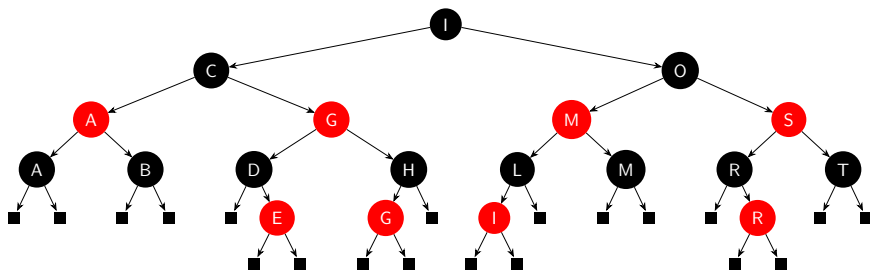

Inserting 'J'

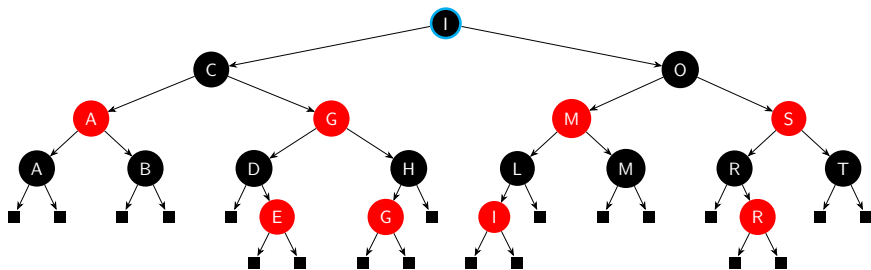

Inserting 'J'

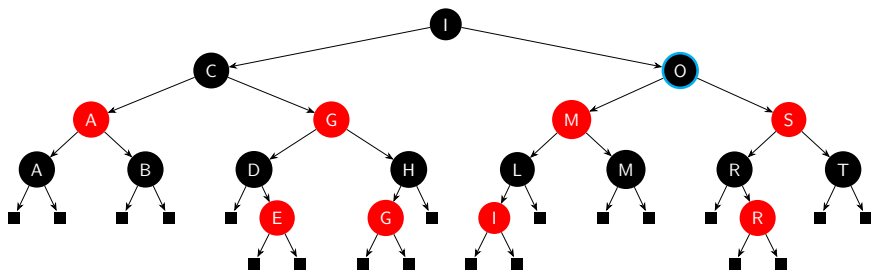

Inserting 'J'

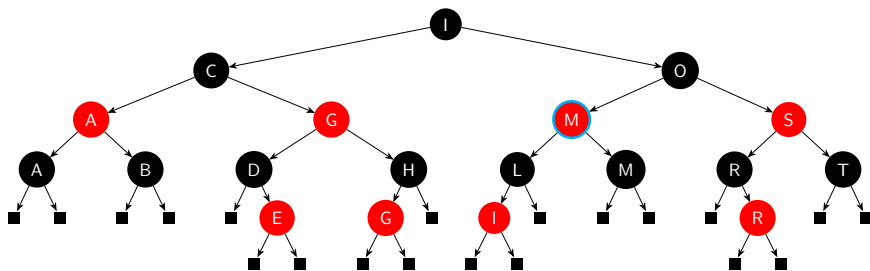

Inserting 'J'

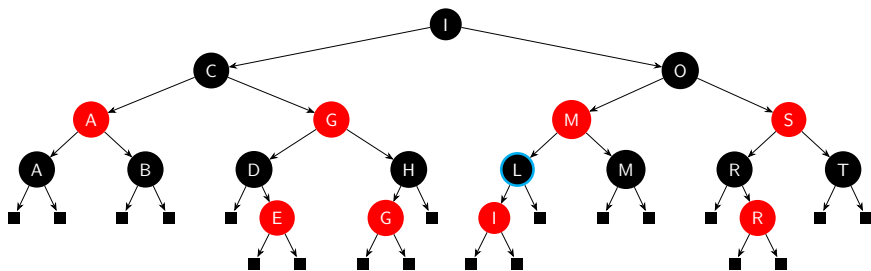

Inserting 'J'

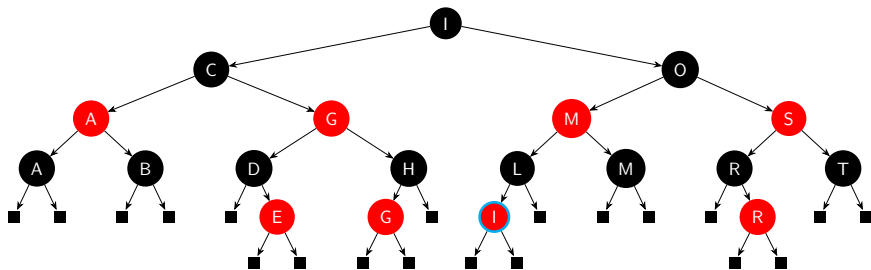

Inserting 'J'

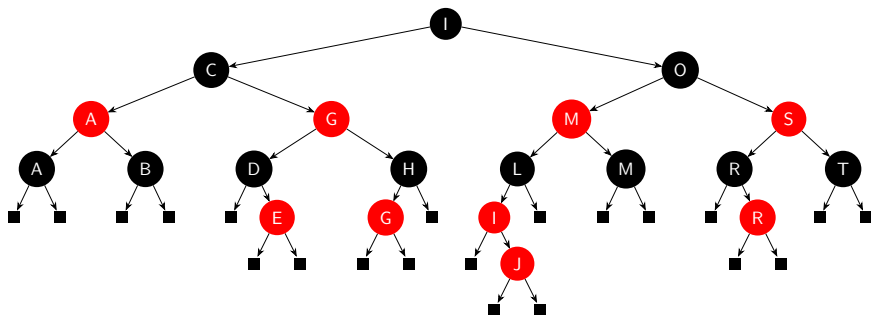

Inserting 'J'

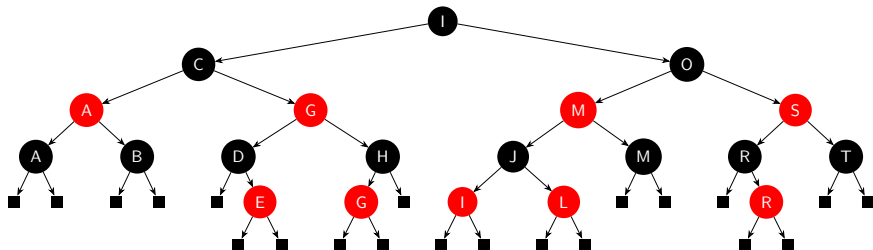

Inserting 'R'

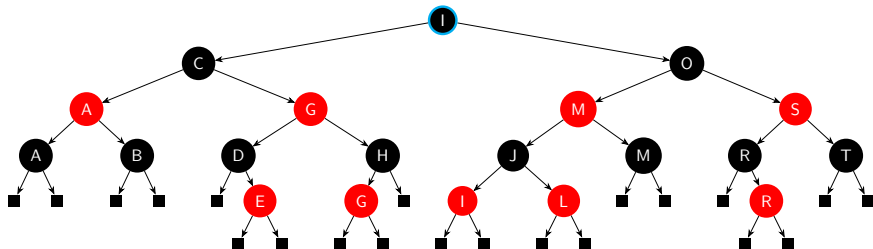

Inserting 'R'

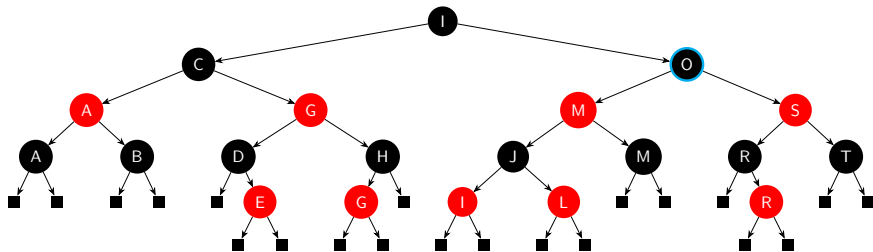

Inserting 'R'

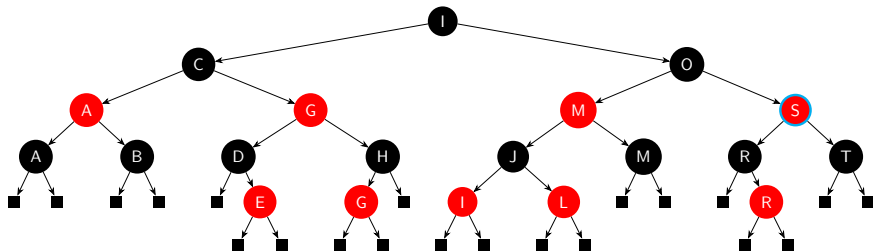

Inserting 'R'

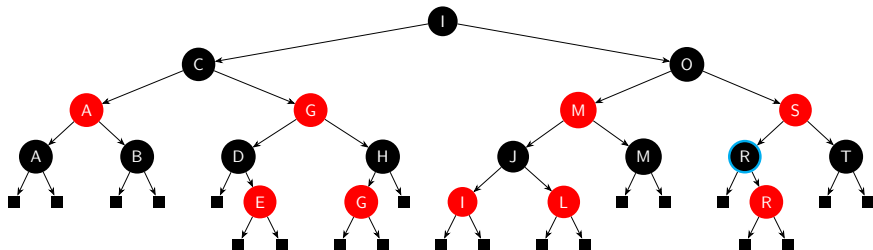

Inserting 'R'

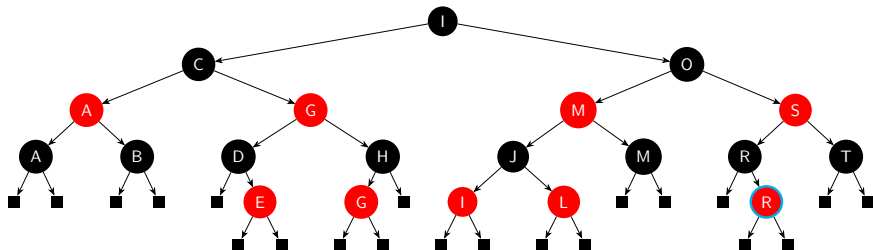

Inserting 'R'

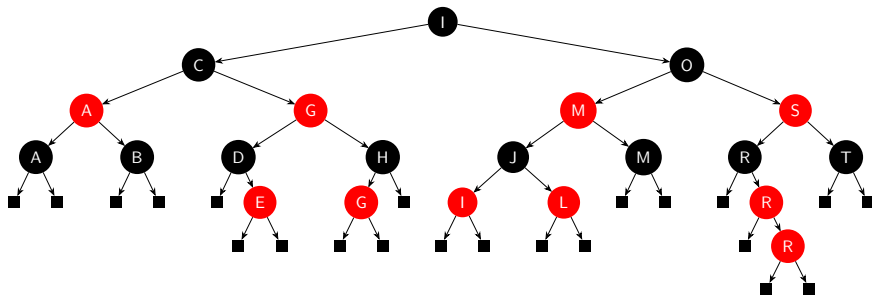

Inserting 'R'

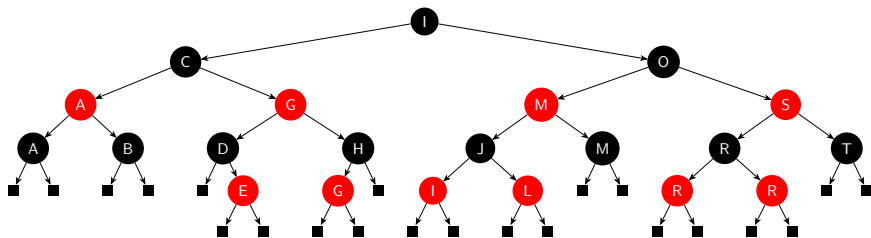

Inserting 'T'

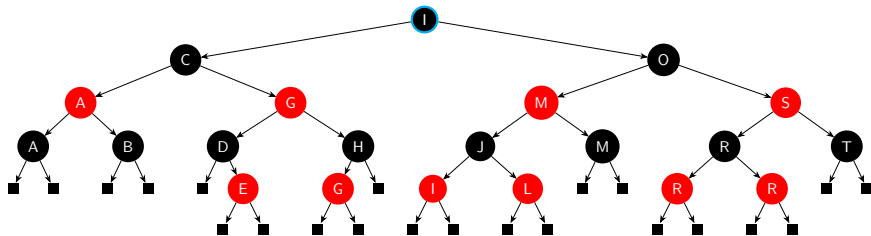

Inserting 'T'

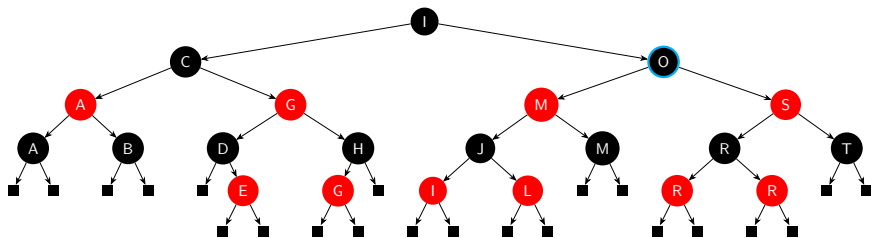

Inserting 'T'

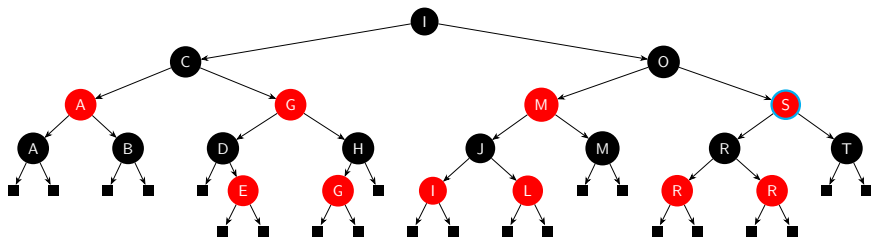

Inserting 'T'

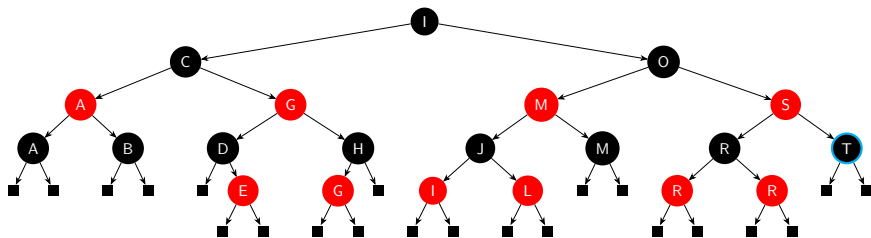

Inserting 'T'

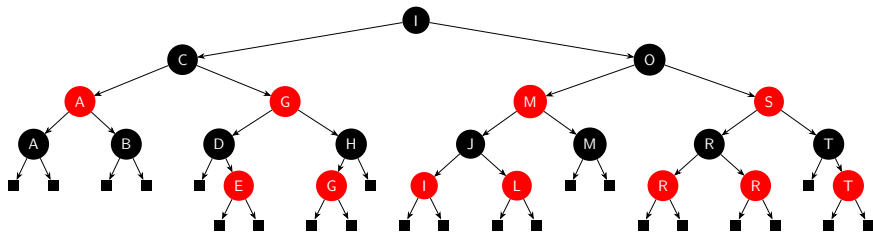

Inserting 'C'

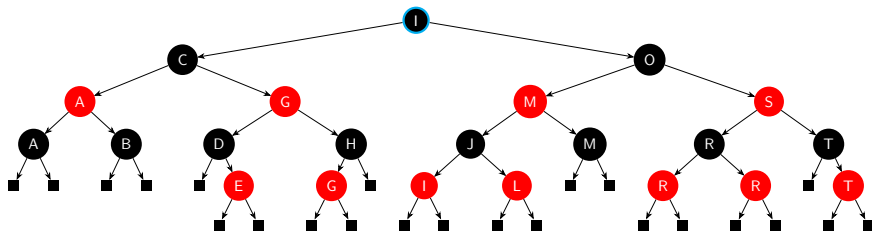

Inserting 'C'

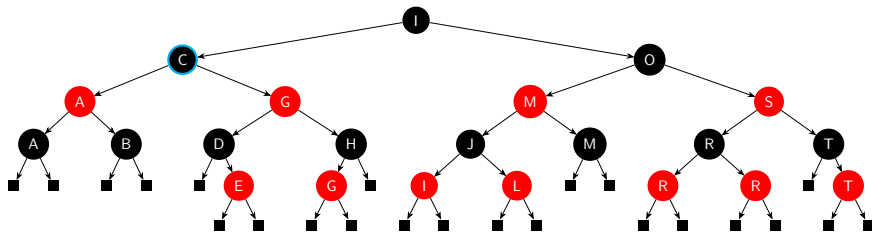

Inserting 'C'

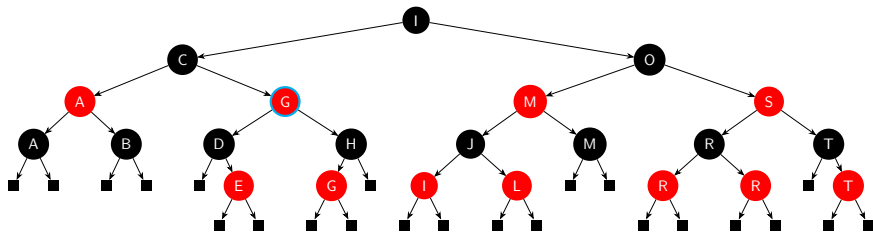

Inserting 'C'

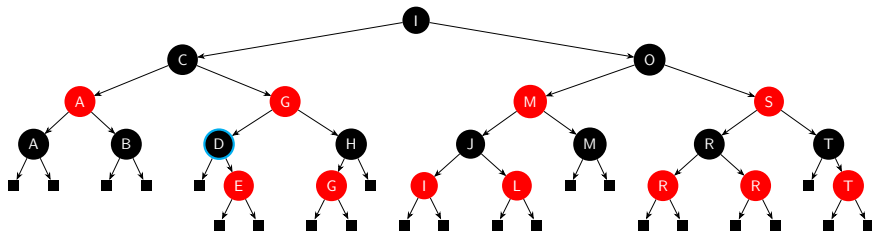

Inserting 'C'

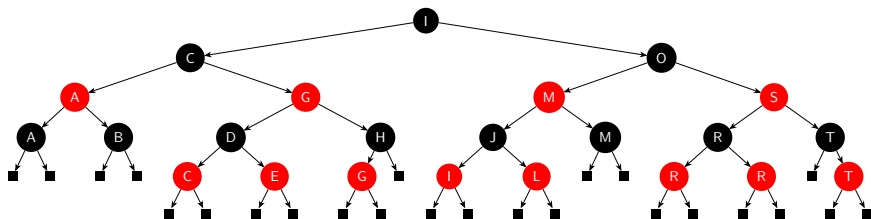

Inserting '4'

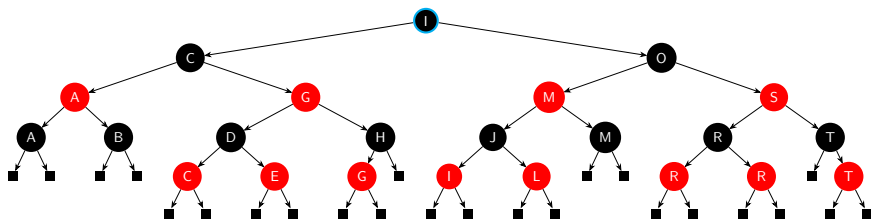

Inserting '4'

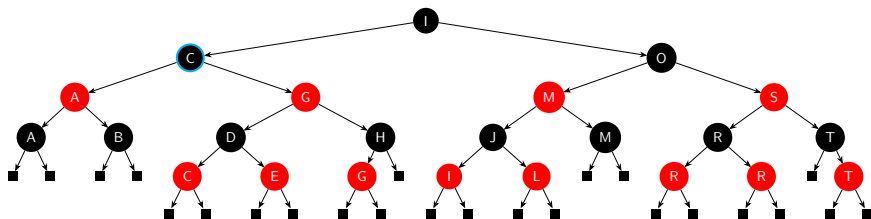

Inserting '4'

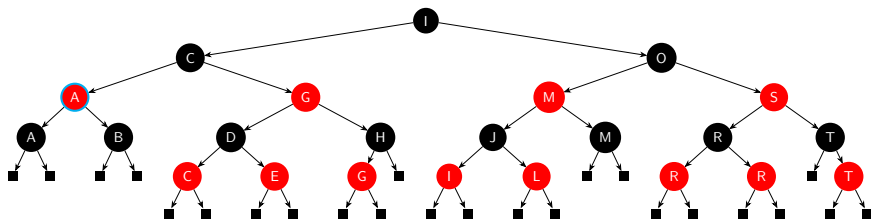

Inserting '4'

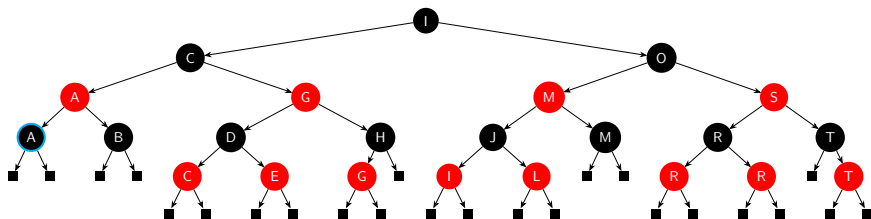

Inserting '4'

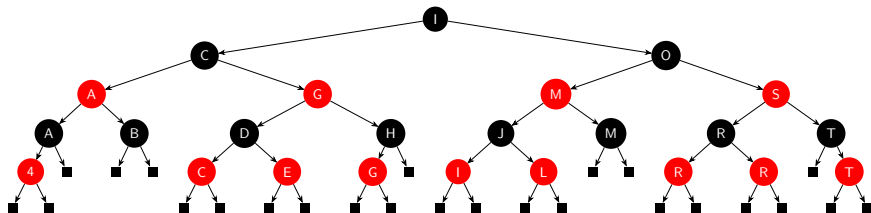

Finding 'A'

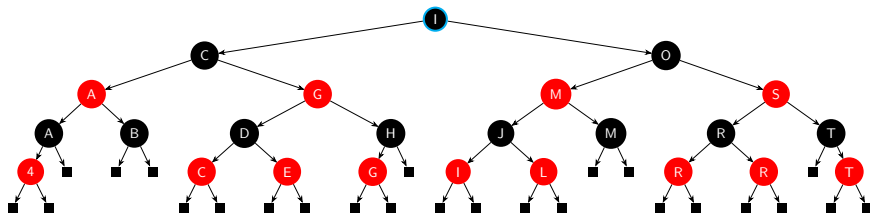

Finding 'A'

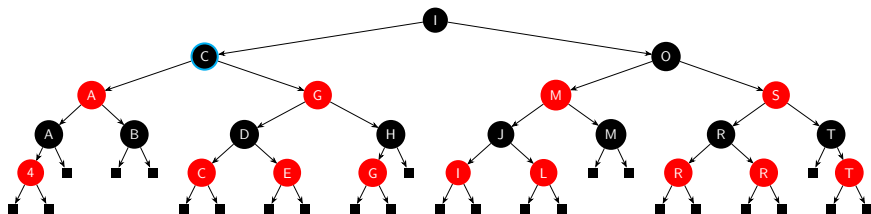

Finding 'A'

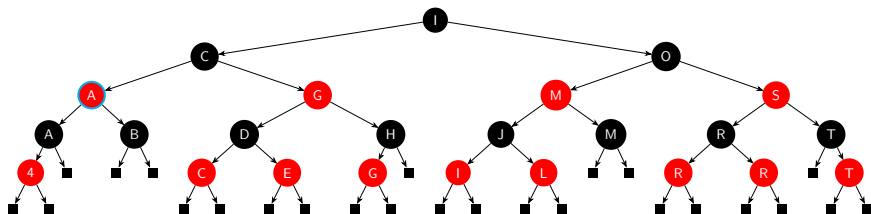

Finding 'A'

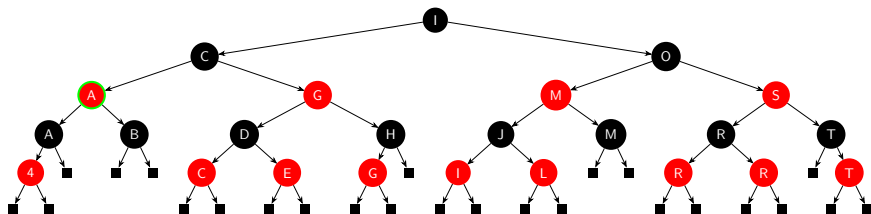

Finding 'Z'

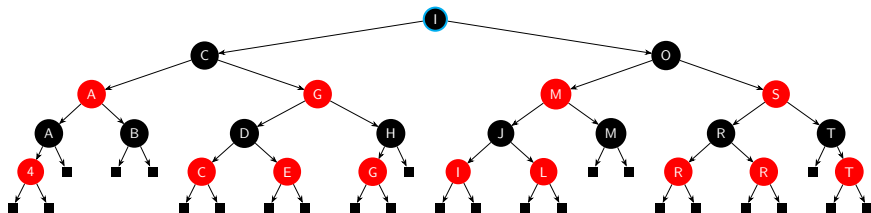

Finding 'Z'

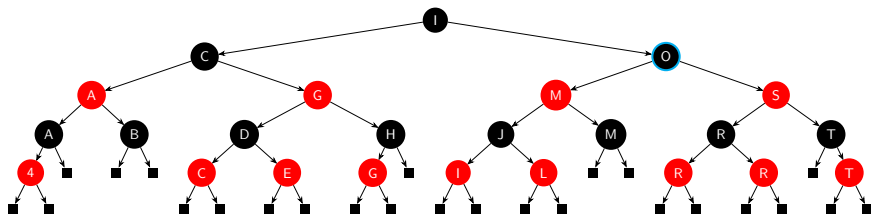

Finding 'Z'

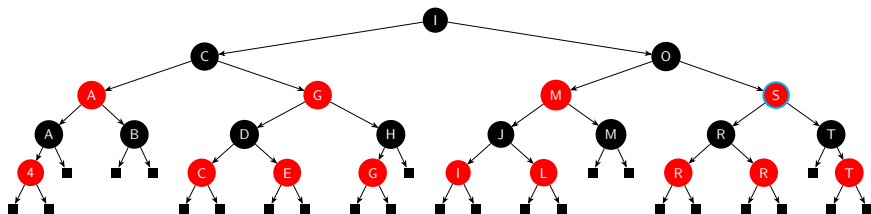

Finding 'Z'

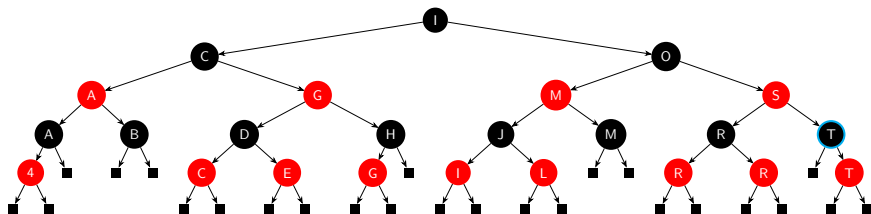

Finding 'Z'

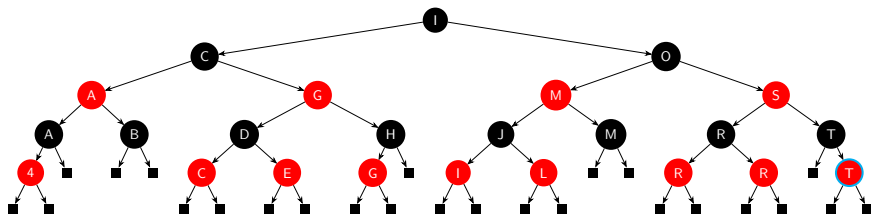

Predecessor of 'M'

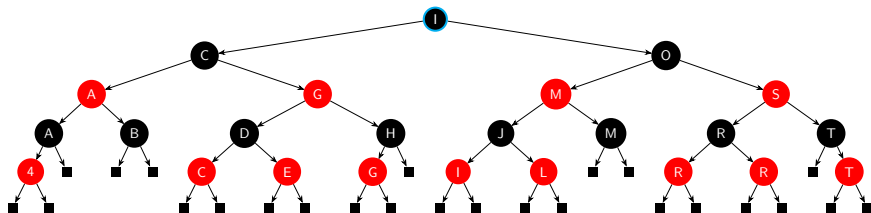

Predecessor of 'M'

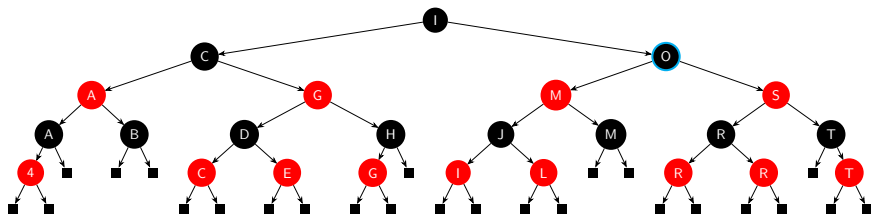

Predecessor of 'M'

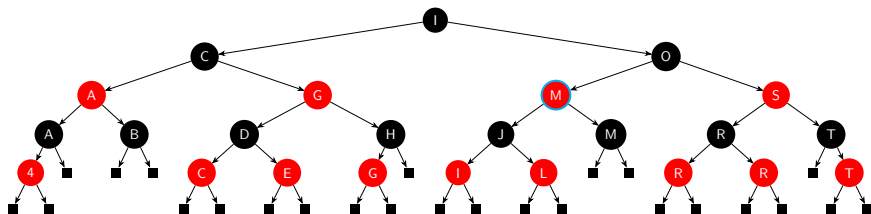

Predecessor of 'M'

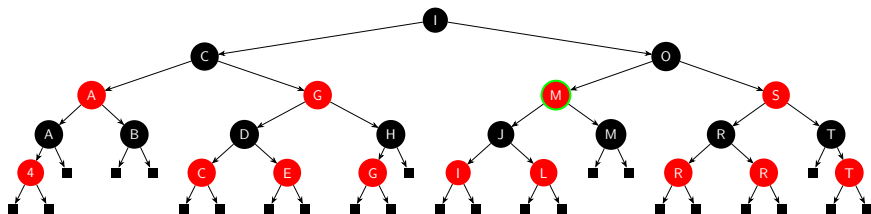

Predecessor of 'M'

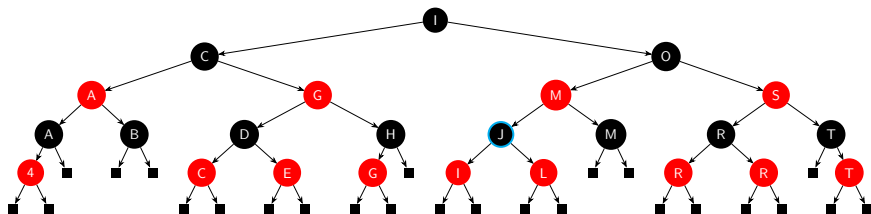

Predecessor of 'M'

