

Young Persons Guide to BCPL Programming on the Raspberry Pi Part 1

by

Martin Richards

mr@cl.cam.ac.uk

<http://www.cl.cam.ac.uk/~mr10/>

Computer Laboratory
University of Cambridge

Revision date: Tue Oct 23 16:58:19 BST 2018

Abstract

The Raspberry Pi is a credit card sized computer with versions costing between £20 and £35. It runs a full version of the Linux Operating System. Its files are held on an SD card typically holding between 2 and 32 Giga-bytes of data. When connected to a power supply, a USB keyboard and mouse, and attached to a TV via an HDMI cable, it behaves like a regular laptop running Linux. Programs for it can be written in various languages such as Python, C and Java, and systems such as Squeak and Scratch are fun to use and well worth looking at. This document is intended to help people with no computing experience to learn to write, compile and run BCPL programs on the Raspberry Pi in as little as one or two days, even if they are as young as 10 years old.

Although this document is primarily for the Raspberry Pi, all the programs it contains run equally well (or better) on any Linux, Windows or OSX system.

Keywords

BCPL, Programming, Raspberry Pi, Graphics.

Acknowledgements

I would particularly like to thank Philip Hazel for his helpful advice on how to improve this document.

Contents

Preface	v
1 Setting up the Raspberry Pi	1
1.1 Later versions of the Raspberry Pi	3
2 SD Card Initialisation	5
2.1 A More Recent SD Card Image	10
2.2 NOOBS	11
2.3 Raspberry Pi Model 3	11
3 Introduction to Linux	13
3.1 The Filing System	15
3.2 The Desktop	17
3.3 Midori	18
3.4 Editing Files	19
3.5 vi	19
3.6 emacs	21
4 The BCPL Cintcode System	25
4.1 Installation of BCPL	26
4.2 Hello World	31
4.3 Fibonacci	34
4.4 Multiplication Table	42
4.5 A Mathematician's Approach	43
4.6 Numbers	47
4.7 Applications of XOR and MOD	50
4.7.1 RSA Mathematical Details	52
4.8 Vectors	53
4.9 Primes	57
4.10 MANIFEST, GLOBAL and STATIC declarations	58
4.11 Functions	60
4.12 Solving the recurrence relation for C	63
4.13 Greatest Common Divisor	64

4.14 Powers	65
4.15 Compilation	66
4.16 The Collatz Conjecture	72
4.17 The Pig Dice Game	78
4.17.1 The Optimum Strategy	86
4.18 The Enigma Machine	89
4.18.1 <code>enigma-m3</code> functions	95
4.19 Breaking the Enigma Code	123
4.20 The Advanced Encryption Standard	132
4.20.1 Final Observation	146
4.21 GF(2^8) Arithmetic	149
4.22 Polynomials with GF(2^8) Coefficients	151
4.23 Reed-Solomon Error Correction	155
4.24 The Queens Problem	172
4.25 Sudoku	175
4.26 The Sliding Blocks Puzzle	183
4.27 The Rubik Cube	203
4.28 Simple series	241
4.29 e to 2000 decimal places	244
4.30 The χ^2 test	248
4.31 e^x	249
4.32 The extraordinary number $e^{\pi\sqrt{163}}$	250
4.33 Digits of π	256
4.34 More commands	262
4.35 The VSPL Compiler	263
4.36 Summary of BCPL	264
4.36.1 Comments and <code>GET</code>	264
4.36.2 Sections	265
4.36.3 Declarations	265
4.36.4 Definitions	265
4.36.5 Expressions	265
4.36.6 Commands	267
4.36.7 Constant expressions	268
4.37 Debugging Techniques	269
4.37.1 Adding debugging output to a program	271
4.37.2 Using the interactive debugger	276
4.37.3 Summary	286
5 Interactive Graphics in BCPL using SDL	301
5.1 Introduction	301
5.2 The dragon curve	305
5.3 The Game of life	308
5.4 Collatz Revisited	310

5.5	sdinfo.b	312
5.6	Graphs	315
5.7	Gradients	318
5.8	Events	321
5.9	e^{ix} and rotation	325
5.10	The Riemann ζ -function	337
5.11	Polar Coordinates	338
5.12	The Mandelbrot Set	338
5.13	Ball and Bucket Game	350
5.14	The A* Algorithm	380
5.15	Robots	402
5.16	Moon Lander	444
5.17	A Library for High Precision Arithmetic	459
	5.17.1 A Simple Example	486
5.18	The Airy Disk	492
5.19	A Catadioptric Telescope	504
5.20	A 3D Demo using SDL	550
6	Interactive Graphics in BCPL using OpenGL	606
6.1	Introduction to OpenGL	607
6.2	Geometric Transformations	608
6.3	Viewing the Scene	611
6.4	A first OpenGL example	615
A	sd1.h	715
B	sd1.b	722
C	gl.h	742
D	gl.b	747
E	gl.b	763
F	Package Installation Details	790
	F.0.1 Installing BCPL under Linux, the Raspberry Pi and Mac OSX	790
	F.0.2 Installing Emacs under Linux, the Raspberry Pi and Mac OSX	791
	F.0.3 Installing SDL under Linux and the Raspberry Pi	792
	F.0.4 Installing SDL2 under Linux and the Raspberry Pi	793

Preface

When a new programming language is designed it is invariably strongly influenced by languages that preceded it. One thread of related languages is: Algol -> CPL -> BCPL -> B -> C -> C++ -> Java, indicating that BCPL is just a small link in the chain from the development of Algol in the late 1950s to Java in the 1980s. BCPL is particularly easy to learn and is thus a good choice as a first programming language. It is freely available via my home page (www.cl.cam.ac.uk/~mr10) and the only file to download is called `bcpl.tgz`. This is easy to decompress and install on the Raspberry Pi and so, in very little time, you can have a usable BCPL system running on your machine.

The main topics covered by this document are:

- How to connect the Raspberry Pi to a television, keyboard, mouse, and power supply.
- How to initialise its SD card with a version of the Linux Operating System.
- How to login to the Raspberry Pi followed by a brief description of a few Linux Shell commands.
- How to obtain and install BCPL on the Raspberry Pi.
- Then follows a series of examples showing how to write, compile and run BCPL programs.
- Near the end there are some example programs involving interactive graphics using the BCPL interface to the SDL graphics library.
- Finally, there is a section outlining some of the debugging aid provided by the BCPL system.

Professional computer scientists require a reasonable grounding in mathematics and so some mathematics has been included in this document, but even though some is of university level, the approach taken requires very little mathematical background, and should be understandable by most young people. But if this is not to your taste, skip any sections remotely connected with mathematics.

Chapter 1

Setting up the Raspberry Pi

The Raspberry Pi is a credit card sized computer that runs the freely available Linux Operating System. I recommend using the Model B version, as shown in Figure 1.1, since it is more powerful and not much more expensive than Model A. It is powered by a typical mobile phone charger using a micro USB connector, but be careful to choose a charger that can supply at least 700 milli-amps.



Figure 1.1: Raspberry Pi with connectors

The Raspberry Pi can be connected to a TV using an HDMI cable although an analogue connection is also available. With some early versions of Linux for the Raspberry Pi, the HDMI connection failed to work properly. Luckily these early problems seem to have gone away with later versions of the software.

A USB keyboard and mouse is required and a combined wireless keyboard and touch pad is particularly convenient since it allows you to sit in the comfort of an armchair with the keyboard on your knee and the Raspberry Pi neatly hidden behind the TV. The lack of unsightly trailing cables is a clear bonus and leaving the second USB socket free is an added advantage. My favourite keyboard is made by Sandstrøm (available from PC World for about £30). A radio keyboard with a separate mouse might be even better. The picture of the Raspberry Pi shows the tiny USB radio dongle for the keyboard to the left, the HDMI cable above and the micro USB connector for the charger to the right.

Figure 1.2 shows the Raspberry Pi fully connected only requiring the HDMI lead to be connected to a TV and the charger plugged into a socket. Notice that at the right side of the machine, you can see part of the blue SD memory card which has to be preloaded with a suitable version of Linux. If you have access to the internet, you can plug a suitable ethernet cable into the Raspberry Pi. This is not absolutely necessary but does have many advantages, particularly for the automatic setting of the date and time, web browsing and downloading software.

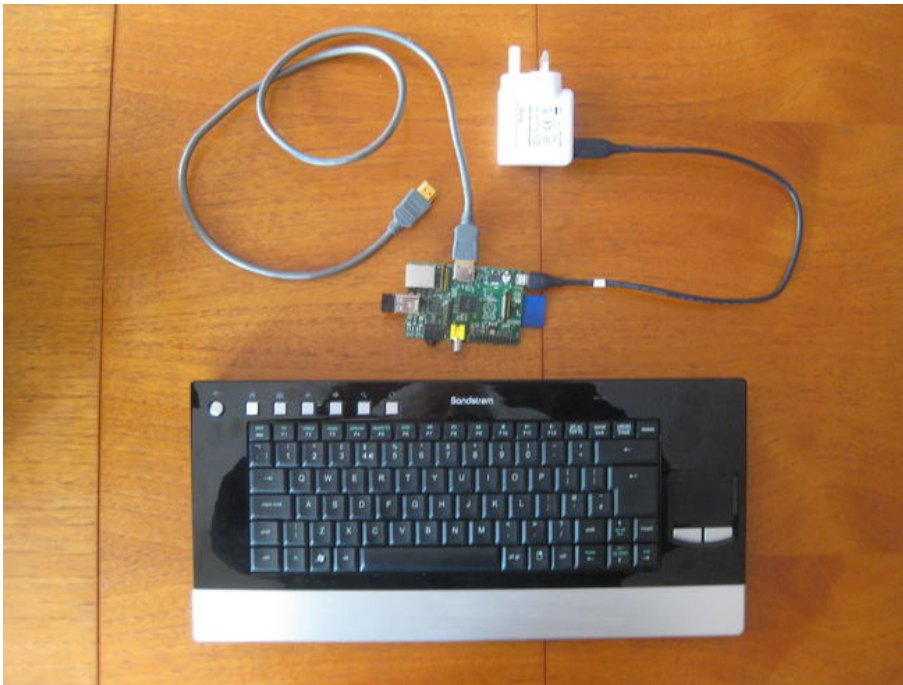

Figure 1.2: Raspberry Pi and keyboard fully connected

The SD card should have a size between 8 and 32 GBytes, although I currently recommend using a card of either 8 or 16 GBytes. I have noticed that some SD cards seem not to work. There are several good web pages supplied by the Raspberry Pi community that describe how to load the Linux image into the SD card. The version of Linux I currently use allows me to login as user `pi`

with password `raspberry` leaving me connected to a `bash` shell waiting for Linux commands.

Figure 1.3 shows a more extensive setup of the Raspberry Pi. This time it is connected to the internet by cable and has a powered 4-port USB Hub connected to the second USB port. The Hub itself is connected to a 500 Gbyte USB disc drive. The screen shows a typical LXDE desktop with a Midori web browser showing some photos and a terminal session demonstrating the BCPL Cintcode System.



Figure 1.3: A more extensive setup

1.1 Later versions of the Raspberry Pi

In early February 2015, a new version of the Raspberry Pi became available. It has 1Gb of RAM, 4 USB sockets and is about six times faster than the earlier version. It uses a micro SD card for its disk memory and the machine still costs about the same as the previous version. A major advantage is that its operating system provides full support for floating point machine instructions which is invaluable

since BCPL now supports floating point which is used extensively in programs involving OpenGL graphics. I therefore strongly advise you to upgrade to this version and buy a good quality fast (class 4) micro SD card, typically of size 8Gb. This machine is shown in Figure 1.4.

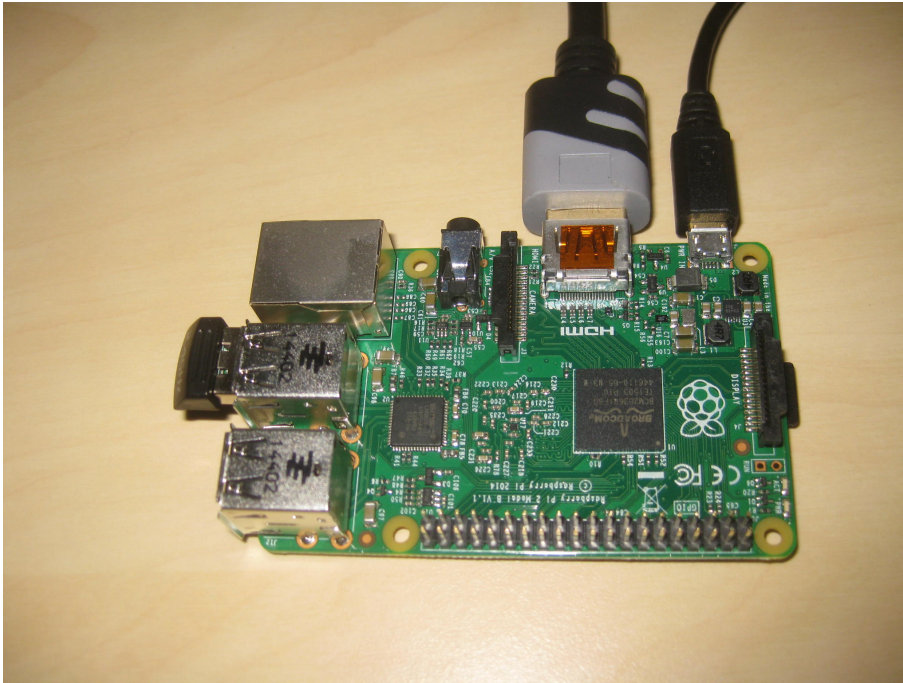

Figure 1.4: The Raspberry Pi Model B-2

Chapter 2

SD Card Initialisation

This chapter was written when the Raspberry Pi first became available. At that time setting up the SD card was quite tricky but now it has all become much easier and so I recommend you skip to Section NOOBS near the end of this chapter which describes a much more convenient way to setup the SD card.

The SD memory card must be initialised with a suitable version of Linux and this chapter outlines how this can be done. Since it is potentially a dangerous operation I strongly recommend you look at the various tutorials and videos on the Web supplied by members of the Raspberry Pi community. A good place to start is to do a google search on: Raspberry Pi SD card setup, and also look at the web page: www.raspberrypi.org/downloads.

You will need access to a desktop or laptop computer running some version of Windows, OSX or Linux, and a connection to the internet. I used a laptop computer (called `solestreet`) running Linux to perform the download and all the operations needed to initialise the SD card. I strongly recommend using Linux and in particular the Wubi version of Ubuntu Linux for many reasons. Firstly, it is easy to install on Windows machines without needing the tricky and potentially dangerous job of repartitioning your hard disc. It allocates one large file on Windows to hold the entire Linux filing system. I would recommend allocating 20 Gbytes if you can spare that much, but less will work. You can uninstall Wubi Linux in exactly the same way you uninstall other Windows programs, and again there is no need to repartition the hard disc. Secondly, it has a lot in common with the Linux system you will be using on the Raspberry Pi, including, for instance, the `apt-get` mechanism for downloading and installing Linux packages. Finally, it already has most of the commands installed such as `ls`, `cd`, `df`, `dd`, `sudo`, `parted`, `e2fsck`, `fdisk` and `resize2fs` that you will need when setting up the SD card. Even if some are absent, they are easily obtained by commands such as: `sudo apt-get install parted`. A further advantage is that all the fragments of terminal sessions in this chapter were run using the Wubi version of Linux on my laptop. I believe Wubi Linux already has the Workspace Switcher program which allows to the switch easily between four separate screens. Two other programs

I strongly recommend installing `Terminator` which is a brilliant terminal program and `emacs` which is my favourite screen editor for editing text files. If suitably configured, `emacs` will give different colours to reserved words, strings, comments and other lexical features of BCPL programs making them easier to read. I would also recommend installing `emacs` on the Raspberry Pi for the same reason. Details of how to use `emacs` will be given later.

Using a web browser you should be able to download a suitable Linux image. The recommended Debian "squeeze" is ideal and the one I used was called: `2012-07-15-wheezy-raspbian.zip`, but its name keeps changing as updates are made. The zip file can be expanded to produce the image file called: `2012-07-15-wheezy-raspbian.img`.

I connected a 500 Gbyte external USB disc drive to the laptop and so had plenty of disc space for both the zip and image files. The USB drive turned out to have name `/media/TOSHIBA\ EXT` and so I changed to this directory, created a subdirectory directory called `raspi` and made it the current directory. The commands used were:

```
solestreet:$ cd /media/TOSHIBA\ EXT
solestreet:$ mkdir raspi
solestreet:$ cd raspi
solestreet:$
```

I used a web browser to download `debian6-19-04-2012.zip` into this directory and inspected the result.

```
solestreet:$ ls -lrt
total 453696
-rw----- 1 mr10 mr10 461001289 Jul 23 14:07 2012-07-15-wheezy-raspbian.zip
solestreet:$
```

I then checked the checksum using `sha1sum` and expanded the file using `unzip`.

```
solestreet:$ sha1sum 2012-07-15-wheezy-raspbian.zip
3947412babbf63f9f022f1b0b22ea6a308bb630c 2012-07-15-wheezy-raspbian.zip
solestreet:$
solestreet:$ unzip 2012-07-15-wheezy-raspbian.zip
Archive: 2012-07-15-wheezy-raspbian.zip
  inflating: 2012-07-15-wheezy-raspbian.img
solestreet:$ ls -lrt
total 2344600
-rw----- 1 mr10 mr10 1939865600 Jul 15 20:45 2012-07-15-wheezy-raspbian.img
-rw----- 1 mr10 mr10 461001289 Jul 23 14:07 2012-07-15-wheezy-raspbian.zip
solestreet:$
```

This takes some time so be patient, but when it completes, it will have created the file `2012-07-15-wheezy-raspbian.img`. The size of this image is very nearly 2 Gbytes which just fits on a 2 Gbyte SD card, but later images are likely to be bigger so it would be wise to buy SD cards of at least 4 Gbytes.

Now come the tricky and potentially dangerous part. This file represents the complete image of what must be written to the SD card destroying everything that was previously on it. If you accidentally write it to the wrong place, you may well make your laptop or desktop unusable, so great care is required.

My laptop has a slot for an SD card and so can be conveniently used to initialise the card. First, I executed the `df -h` command producing the following output.

```
solestreet:~$ df -h
Filesystem      Size  Used Avail Use% Mounted on
/dev/sda6        32G   16G   14G  53% /
udev            743M   4.0K  743M   1% /dev
tmpfs           300M   840K  300M   1% /run
none            5.0M   8.0K   5.0M   1% /run/lock
none            750M   344K  750M   1% /run/shm
/dev/sda7        100M    75M   20M  80% /boot
/dev/sda2        4.0G   2.5G   1.6G  63% /dosc
/dev/sdb1        466G    25G  441G   6% /media/TOSHIBA EXT
solestreet:~$
```

I then inserted a suitable SD card (a Verbatim 4Gbyte card) and ran the command again giving:

```
solestreet:~$ df -h
Filesystem      Size  Used Avail Use% Mounted on
/dev/sda6        32G   16G   14G  53% /
udev            743M   4.0K  743M   1% /dev
tmpfs           300M   852K  300M   1% /run
none            5.0M   8.0K   5.0M   1% /run/lock
none            750M   344K  750M   1% /run/shm
/dev/sda7        100M    75M   20M  80% /boot
/dev/sda2        4.0G   2.5G   1.6G  63% /dosc
/dev/sdb1        466G    25G  441G   6% /media/TOSHIBA EXT
/dev/mmcb1k0p1    58M    34M   24M  59% /media/18DA-FFB9
/dev/mmcb1k0p2   3.7G   1.5G   2.0G  43% /media/a6b2691a-99d8-47...
solestreet:~$
```

This shows that the SD card was called `/dev/mmcb1k0` and already had two partitions on it, one of size 58 Mbytes and the other of size 3.7 Gbytes. I unmounted

both these two partitions using the `umount` command twice and used the `sudo dd` command to copy the Raspbian Linux image to the SD card. This is the command that required special care since mistakes can make your machine unusable. The commands used were as follows:

```
solestreet:$ umount /dev/mmcblk0p1
solestreet:$ umount /dev/mmcblk0p2
solestreet:$
solestreet:$ sudo dd bs=1M if=2012-07-15-wheezy-raspbian.img of=/dev/mmcblk0
[sudo] password for mr10:
1850+0 records in
1850+0 records out
1939865600 bytes (1.9 GB) copied, 468.454 s, 4.1 MB/s
solestreet:$
```

As can be seen, this took 468 seconds or nearly 8 minutes so patience is again required. I then extracted the SD card after issuing the `sync` command to ensure that all disc transfers have completed.

```
solestreet:$ sync
solestreet:$
```

I re-inserted the SD card to see what it contained.

```
solestreet:$ df -h
Filesystem      Size  Used Avail Use% Mounted on
/dev/sda6        32G   16G   14G  53% /
udev            743M   4.0K  743M   1% /dev
tmpfs           300M   852K  300M   1% /run
none            5.0M   8.0K   5.0M   1% /run/lock
none            750M   344K  750M   1% /run/shm
/dev/sda7        100M    75M   20M  80% /boot
/dev/sda2        4.0G   2.5G   1.6G  63% /dose
/dev/sdb1        466G    25G  441G   6% /media/TOSHIBA EXT
/dev/mmcblk0p1   56M    34M   23M  61% /media/1AF7-904A
/dev/mmcblk0p2  1.8G   1.3G  439M  75% /media/8fe3c9ad-c8f5-4b39-aec2-f6e8dba743e0
solestreet:$

solestreet:$
solestreet:$ cd /media/8fe3c9ad-c8f5-4b39-aec2-f6e8dba743e0
solestreet:$ ls
bin  dev  home  lost+found  mnt  proc  run  selinux  sys  usr
boot  etc  lib  media      opt  root  sbin  srv      tmp  var
solestreet:$
```

Note that the horrible looking `cd` command is easy to type because you only have to input `cd /media/8` and then press the Tab key for `bash` to fill in the rest of the file name automatically.

The directory `home` contains all the home directories of users permitted to use the machine, however at this stage no users are set up. The first time this image is run on the Raspberry Pi, it creates a user called `pi` with password `raspberrypi`.

Our next job is to extract the SD card from the laptop and insert it into the SD slot on the Raspberry Pi. Assuming a suitable keyboard and mouse is attached and the HDMI lead is connected to a TV or suitable screen, we can plug in the power and watch the Raspberry Pi initialise itself. The first time you use a new image extra initialisation is done and it asks you a few configuration questions. You should agree to let the system expand the root filing system to fill your SD card. If you do not you will be limited to a mere 2 Gbyte of filing system which is unlikely to be enough for your needs. The other options are up to you. You should then let the system reboot. With the default settings, the system will eventually issue a prompt looking something like the following.

```
Debian GNU/Linux wheezy/sid raspberrypi tty1
```

```
raspberrypi login:
```

You should respond by typing the user name `pi` remembering to press the Enter key. It will then ask for the password and your response should be: `raspberrypi`, again remembering to press the Enter key. It will then output about 6 lines ending with a Linux shell prompt such as the following:

```
Debian GNU/Linux 6.0 raspberrypi tty1
```

```
pi@raspberrypi:~$
```

If you get this far, you are now in business and can begin to use Linux on your Raspberry Pi. Well done!

If your Raspberry Pi was connected to the internet, it will have automatically set the time and date, but if not you should correct the time using the `sudo date` command as shown below.

```
pi@raspberrypi:~$ date
Tue Apr 17 14:15:04 BST 2012
pi@raspberrypi:~$ sudo date --set="2012-04-23 12:27"
Mon Apr 23 12:27:00 BST 2012
pi@raspberrypi:~$ date
Mon Apr 23 12:27:04 BST 2012
pi@raspberrypi:~$
```

2.1 A More Recent SD Card Image

Since the Raspberry Pi SD card image is repeated upgraded, I have recently (October 2014) re-installed the wheezy-raspbian image on a 4Gbyte SD card. The console session was as follows. You will see that is close the description above.

```
solestreet:$ sha1sum 2014-09-09-wheezy-raspbian.zip
951a9092dd160ea06195963d1afb47220588ed84 2014-09-09-wheezy-raspbian.zip
solestreet:$
solestreet:$ unzip 2014-09-09-wheezy-raspbian.zip
Archive: 2014-09-09-wheezy-raspbian.zip
  inflating: 2014-09-09-wheezy-raspbian.img
solestreet:$ ls -lrt *.img
-rw----- 1 mr10 mr10 1939865600 Jul 15 2012 2012-07-15-wheezy-raspbian.img
-rw----- 1 mr10 mr10 3965190144 Feb 13 2013 img130213.img
-rw----- 1 mr10 mr10 1939865600 May 25 2013 2013-05-25-wheezy-raspbian.img
-rw----- 1 mr10 mr10 4031774720 Oct 14 2013 sdcard14-10-13.img
-rw----- 1 mr10 mr10 3276800000 Sep 9 09:42 2014-09-09-wheezy-raspbian.img
solestreet:$
solestreet:$ df
Filesystem      1K-blocks      Used Available Use% Mounted on
/dev/sda6        32274308 24446852   6187984 80% /
udev             760316         4     760312 1% /dev
tmpfs           153524         880   152644 1% /run
none            5120           8     5112 1% /run/lock
none           767600         80    767520 1% /run/shm
/dev/sda7        100148       53544   41433 57% /boot
/dev/sda2        4184772    3245360   939412 78% /dose
/dev/sdb1       488383484 35674332 452709152 8% /media/TOSHIBA EXT
solestreet:$
solestreet:$ df
Filesystem      1K-blocks      Used Available Use% Mounted on
/dev/sda6        32274308 24446900   6187936 80% /
udev             760316         4     760312 1% /dev
tmpfs           153524         896   152628 1% /run
none            5120           8     5112 1% /run/lock
none           767600         80    767520 1% /run/shm
/dev/sda7        100148       53544   41433 57% /boot
/dev/sda2        4184772    3245360   939412 78% /dose
/dev/sdb1       488383484 35674336 452709148 8% /media/TOSHIBA EXT
/dev/mmcbk0p1    76186        28089   48097 37% /media/95F5-0D7A
/dev/mmcbk0p2    3599168    1671940 1744512 49% /media/18c27e44-ad29-4264-...
solestreet:$
solestreet:$ umount /dev/mmcbk0p1
```

```
solestreet:$ umount /dev/mmcblk0p2
solestreet:$
solestreet:$ sudo dd bs=4M if=2014-09-09-wheezy-raspbian.img of=/dev/mmcblk0
[sudo] password for mr10:
781+1 records in
781+1 records out
3276800000 bytes (3.3 GB) copied, 597.799 s, 5.5 MB/s
solestreet:$
solestreet:$
solestreet:$ sync
solestreet:$
```

2.2 NOOBS

This section briefly describes how to setup the SD card using the recently developed NOOBS disc image. This is much simpler to deal with than the mechanism described in the previous sections. You can find out how to download and install NOOBS on an SD card by doing a web search on [raspberry pi downloads](#). There you will find good documentation on how to setup the SD card using a machine running Windows, Mac OS or Linux. When running NOOBS on the Raspberry Pi for the first time, you are given the choice of several operating systems to install but you should choose **Raspbian**. Remember that the size of the SD card must at least 8 Gbytes and probably 16 Gbytes would be better.

Remember that the Raspberry Pi has no battery backed up clock so every time you reboot and login to the system you should reset the time and date by a commands similar to the following.

```
pi@raspberrypi:~$ date
Tue Apr 17 14:15:04 BST 2012
pi@raspberrypi:~$ sudo date --set="2017-10-26 17:51"
Thu Oct 26 17:51:00 BST 2017
pi@raspberrypi:~$ date
Thu Oct 26 17:51:04 BST 2017
pi@raspberrypi:~$
```

2.3 Raspberry Pi Model 3

The Raspberry Pi Model 3 has been recently announced and I bought one in November 2017 for about 32 using a special deal that included a case. This machine has 1Gb of RAM storage and runs about ten times faster than the original Raspberry Pi. Its major advantage is that it has built-in WiFi hardware eliminating the need to buy a USB WiFi dongle.

Unfortunately, the Raspbian system currently provided by the NOOBS mechanism fails to recognise the WiFi hardware and so I had to find another version to make it work. One that works is:

```
2017-07-05-raspbian-jessie.zip
```

This file can be unzipped to produce the following image file:

```
2017-07-05-raspbian-jessie.img
```

This can be copied to your SD card using the `dd` mechanism described earlier in this chapter, but can now be done more conveniently using `etcher`. I downloaded:

```
etcher-1.2.0-i386.AppImage
```

and copied it into my `bin` directory. Its permissions needed to be changed to make it executable.

```
chmod 755 bin/etcher-1.2.0-i386.AppImage
```

Then change to the directory containing the raspbian-jessie image and use this command to copy the image to your SD card. Take care to ensure that the destination of the copy is indeed your SD card.

Once the card is ready place it in the Raspberry Pi and switch it on. When Linux eventually starts up, start a shell window and enter an editor to modify the file: `/etc/network/interfaces`.

```
sudo vi /etc/network/interfaces
```

Using this editor, ensure that the file contains the following lines:

```
auto lo
iface lo inet loopback
iface eth0 inet dhcp

auto wlan0
iface wlan0 inet dhcp
    wpa-ssid "my-network-ssid"
    wpa-psk "my-wifi-password"
```

replacing `my-network-ssid` and `my-wifi-password` by your router's `ssid` and password. After your next reboot, you should find that your Raspberry Pi is connected to the internet, and you will notice that the date and time of day has been automatically looked up from the internet.

Chapter 3

Introduction to Linux

Assuming that you have successfully logged in to the Raspberry Pi as user `pi` and have the time and date correctly set you should be looking at a `bash` prompt such as:

```
pi@raspberrypi:~$
```

This line is inviting you to type in a command to the `bash` shell. If you press the Enter key several times, it will repeatedly respond with the prompt. Shell commands are lines of text with the first word being the command name and later words being arguments supplied to the given command. For instance, if you type `echo hello` the command name is `echo` and its argument is `hello`. If you then press the Enter key, the machine will load and run the `echo` command outputting its argument as shown below.

```
pi@raspberry:~$ echo hello
hello
pi@raspberry:~$
```

After doing that, the shell is again waiting for a command.

Errors are common when typing commands and the shell is helpful in allowing you to correct such mistakes before they are executed. Suppose you typed `echohello` without a space between the command name and its argument, you could delete the last five characters by pressing the backspace key (often labelled `<-BkSp`) five times then press the space bar followed by `hello`. Alternatively, you could press the left arrow key five times to position the cursor over the `h` of `hello`. Pressing the space bar now will insert a space before the `h` and pressing the Enter key will now cause the corrected command to be executed.

The shell remembers commands you have recently executed and you can search through them using the up and down arrow keys. So rather typing

`echo hello` again, you can find it by pressing the up arrow key once and execute it by pressing Enter. Believe it or not, this is an incredibly useful feature.

We will now look at a few shell commands that you are likely to find useful. Firstly, there is the command `date` which outputs information you might expect. But if the output is wrong, the time and date should be corrected using the `sudo date` command shown in the previous chapter.

When you have finished using the computer, it is important to close it down properly by issuing the command `sudo shutdown -h now` and wait until the machine says it has halted.

There are literally hundreds of shell commands available in Linux and many of them are held in the directories `/bin` and `/usr/bin`. You can see them by typing `ls /bin` and `ls /usr/bin`. But don't be frightened, you will only need to know about perhaps 10 or 15 of them to make effective use of Linux. Linux is to a large extent self documented, and it is possible to learn what commands do using the `man` command. This is a rather sophisticated command that will display manual pages describing almost any command available in the system. The output is primarily aimed at professional users and is highly detailed and often incomprehensible to beginners, but you should just try it once to see the kind of information that is available. Try typing `man echo`. This gives a detailed description of the `echo` command which you can step through using the up and down arrow keys and the space bar. To exit from the `man` command, type `q`. As an example of a really long and complicated command description, try `man bash` and repeatedly press the space bar until you get tired, remembering to press `q` to return to the shell. Again don't be frightened by what you have just seen, you will only be using a tiny subset of the features available in `bash` and this document will show you the ones you are most likely to use.

Sometimes you want to do something but don't know the name of the command to use. The `man -k` command can be helpful in this situation, but it is not always as helpful as you would like. When I first started to use Linux, many years ago, I wanted to delete a file. On previous systems I had used, commands such as `del`, `delete` or `erase` had done the job. Typing `man -k delete` lists about 13 commands that have something to do with deletion but none of the suggested commands would actually delete a file. In Linux deleting a file is called removal and is performed by the `rm` command. It appears in the rather long list generated by `man -k remove`.

The `whoami` outputs your user identifier. On the Raspberry Pi this is likely to be `pi`.

As has been seen the `date` command will either generate the date and time or let you set the date.

The command `cal 2012` will output a calendar for the year 2012. As an interesting oddity try `cal 1752` since this was the year in which some days in September were deleted when there was a switch from the Julian to the Gregorian calendar. Type `man cal` for details.

To execute a command that requires special privileges, you should precede it by `sudo`. It will normally require you to type in a password before it will execute the given command.

Many other commands are associated with files and the filing system. Some of these are described in the next section.

3.1 The Filing System

As we have seen, the SD card holds the image of the Linux system including the built-in shell commands and much more, but it also holds data that you can create. This data is held in files and continues to exist for use on another day, even after you turn the computer off. Files have names and are grouped in directories (often called folders). They typically contain text that can be output to the screen, but files are frequently used for other purposes. The `echo` command, used above, is a file but not a text file. It is actually a program containing a long and complicated sequence of instructions for the computer to obey in order to output its argument to the screen. At this stage it may seem like magic, but after reading this document you will hopefully have a better understanding of how programs are written and how they work.

Directories can contain other directories as well as files and so it is natural to think of the filing system as a tree of files (the leaves) and directories (the branches). At the lowest level is the root which is referred by the special name `/`. We can list the contents of this using the command `ls /` as can be seen below.

```
pi@raspberrypi:~$ ls /
bin      dev  lib  opt  sbin  srv  usr
boot    etc  media  proc  sd    sys  var
Desktop home mnt  root  selinux  tmp
pi@raspberrypi:~$
```

It turns out that all the items in the root directory are themselves directories mostly belonging to the system. As can be seen, one is called `home` which contains the so called home directories of all users permitted to use this computer. Currently there is only one user called `pi` setup. We can show this by listing the contents of `home`.

```
pi@raspberrypi:~$ ls /home
pi
pi@raspberrypi:~$
```

We can also list the contents of the `pi` directory by the following.

```
pi@raspberrypi:~$ ls /home/pi
```

```
pi@raspberrypi:~$
```

This indicates that it is apparently empty. However, it does contain files whose names start with dots (‘.’) that are normally hidden. These can be seen using the `-a` option as in:

```
pi@raspberrypi:~$ ls -a /home/pi
. . . .bash_history .config .lesshst
pi@raspberrypi:~$
```

An absolute file name is a sequence of names separated by slashes (‘/’) and starting with a slash. Such compound names can become quite long. For instance the full file name of the `echo` command is `/usr/bin/echo` as can be found using the `which` command. To reduce the need to frequently have to type long names, Linux has the concept of a current working directory. The absolute name of this directory can be found using the `pwd` command as in:

```
pi@raspberrypi:~$ pwd
/home/pi
pi@raspberrypi:~$
```

File names not starting with a slash are called relative file names and are interpreted as files within the current working directory. In this case, it is as though `/home/pi/` is prepended to the relative file name. You can change the current directory using the `cd` command, as the following sequence of commands shows.

```
pi@raspberrypi:~$ cd /usr/local/lib
pi@raspberrypi:/usr/local/lib$ pwd
/usr/local/lib
pi@raspberrypi:/usr/local/lib$ cd
pi@raspberrypi:/usr/local/lib$ pwd
/home/pi
```

A few more Linux commands relating to files will be given in the next chapter after you have installed the BCPL system.

3.2 The Desktop

After you have logged in to the Raspberry Pi (typically as user `pi` with password `raspberrypi`), you will probably find yourself connected to a `bash` shell waiting for you to enter Linux commands. It is normally more convenient to work within a graphics session since this allows you to interact with several programs using separate windows. To start a graphics session type the command `startx`. After about 10 seconds you will be in a graphics session. You can then use the mouse to move about the screen and press the mouse buttons to cause actions to take place. At the very bottom of the screen there are some tiny icons that are particularly useful. If you move the mouse pointer over one of them and wait a second, it will probably bring up a tiny message reminding you what the icon is for. The little red icon at the bottom right of the screen allows you to logout of the graphics session, returning to the original `bash` shell. The reminder message for this icon just says `logout`. A little further to the left is an icon showing the current time. If you place the mouse pointer over it, it will tell you today's date. Provided you are connected to the internet or you have set the time and date manually, the displayed date should be correct.

Two icons at the bottom near the left side allow you to quickly switch between two separate desktops (`Desktop 1` and `Desktop 2`). This is particularly useful if you want quick access to many windows. Perhaps, one for editing, one for compilations, one for running compiled programs in, one for web browsing, etc, etc. The icon at the bottom left looks like a white bird with a forked tail. If you click the left mouse button on this, it brings up a menu containing about nine items such as `Accessories`, `Education`, `internet`, `Programming`, and several others. For many of these, if you place the mouse pointer over them they bring up sub menus. You can explore these menus using either the mouse or the arrow keys. Suppose you highlight the `Accessories` menu item, pressing Right Arrow will highlight the first item in the `Accessories`' sub menu. You can move up and down this sub menu with the Up and Down Arrow keys, and if you select `Leafpad`, say, and press Enter, a window will appear that allows you to create and edit text files. This is a fairly primitive editor similar to Notepad on computers running Windows.

On the left side of the screen, you should find a column of larger icons for commonly used applications. Probably the most important ones for our purposes are `Midori` a web browser and `LXTerminal` which creates a window allowing you to interact with a `bash` shell. If you place the mouse pointer over the `LXTerminal` icon and then click the left mouse button twice quickly (within about half a second), a window will appear with a `bash` shell prompt. You can test it by typing commands such as `echo hello` or `date`. The top line of the window is called the Title Bar. At its centre will be the title, typically `pi@raspberrypi:~`. If you place the mouse pointer in the title bar and hold down the left button you will find you can drag the window to a new position on the screen. If you place

the mouse pointer carefully at the bottom right corner of the window, the shape of the pointer should change to one looking like an arrow pointing down and to the right. If you now hold down the left button you will be able to drag the bottom right corner of the window to a new position. This allows you to change the size and shape of the window.

Just below the title bar is a menu bar typically holding items like **File**, **Edit**, **Tabs** and **Help**. If you place the pointer over the **Edit** item and press the left button, a menu will appear. Select the item named **Preferences** by highlighting it and press the left button. This will bring up a dialog box that allows you to modify various properties of the window, such as the background and foreground colours. I tend to prefer a background of darkish blue and a foreground of a light blue-green colour. Choose any colours you like but do not make them the same or your text will be invisible!

You can create several LXTerminals by double clicking the **LXTerminal** icon several times. If you move them around you will find some can be partially obscured by others, just like pages of paper on a desk. To bring a window to the top, just place the mouse pointer anywhere on it and click the left button. This is said to also bring the window into *focus* which means that input from the keyboard will be directed at it. You can thus have several **bash** sessions running simultaneously, and you can move from one to another just by moving the mouse and clicking.

3.3 Midori

Midori was a web browser provided by early versions of Linux for the Raspberry Pi. It has since been superseded by most other web browsers fave similar features. The following paragraphs are thus somewhat out of date.

If you double click on the **Midori** icon, it will bring up a window containing the Midori web browser. This allows you to follow links to almost any web page in the world. The only problem is to know what to type. If you happen to know the exact name (or URL) of the page you want to display, you can type it in carefully in the main text field just below the Midori title bar. Such URLs normally start with **http://www.**, for instance, try typing **http://www.cl.cam.ac.uk/~mr10** and press Enter. This should bring up my Home Page. It is however usually easier to find web pages by giving keywords to a search engine. Such keywords can be typed in the smaller text field to the right of the main URL field in Midori. But first I would suggest you select Google as your search engine since this is my favourite. To do this click on the little icon at the left hand end of the text field for keywords. This will bring up a menu of possible search engines, and you should click on Google. Now typing some keywords such as **vi tutorial** and press Enter. Google will respond with many links to web pages that relate to the keywords. Clicking on one of these will open that page. This is a good way to

find documentation and tutorials on almost any topic you are interested in. This particular request will help you with the `vi` editor briefly summarised in the next section.

3.4 Editing Files

In order to program you will need to input and edit text files representing the programs. There are many possible editor programs available for this but I will only mention three of them. First is `Leafpad` mentioned above. It is easy to use but rather primitive and I do not recommend it for editing programs. The next is `vi` which is small, efficient and liked by a surprising number of professional programmers. It has good tutorials on the web, but the version typically installed on the Raspberry Pi has no built in documentation. My favourite text editor is called `emacs`. It is large and sophisticated and much liked by many professional (just as Linux is). It has plenty of built in documentation and is an effective editor even if you use only a tiny proportion of its facilities. The next two sections will give brief instructions on how to use `vi` and `emacs`.

3.5 `vi`

This section contains only a brief introduction to the `vi` editor since there are several excellent tutorials on `vi` some of which are videos. Try doing a web search on `vi tutorial`.

Although I prefer to use the `emacs` editor, `vi` is sometime useful since it is a small program and simple to use. To enter `vi`, type the command `vi filename` where *filename* is the name of a file you wish to create or edit. If you omit the filename, you can still create a file but must give the filename when you write it to disc (using `:w filename`). When `vi` is running it displays some of the text of the file being edited in a window with a flashing character indicating the current cursor position. The cursor can be moved using the arrow keys, or by pressing `h`, `j`, `k` or `l` to move the cursor left, down, up or right, respectively.

`vi` has two modes: *command* and *insert*. When in *insert* mode characters typed on the keyboard are inserted into the current file. Pressing the ESC character causes `vi` to return to *command* mode. In the description that follows *text* represents characters typed in *insert* mode, *ch* represents a single character, **Esc** represents the escape key and **Ret** represents the Enter key. Some of the `vi` commands are as follows.

<code>~</code>	Move the cursor to the first non blank character of the current line.
<code>\$</code>	Move the cursor to the end of the current line.
<code>i <i>text</i> Esc</code>	Insert <i>text</i> just before the cursor.
<code>a <i>text</i> Esc</code>	Insert <i>text</i> just after the cursor.
<code>o <i>text</i> Esc</code>	Create a blank line just after the current line and insert <i>text</i> at its start.
<code>O <i>text</i> Esc</code>	Create a blank line just above the current line and insert <i>text</i> at its start.
<code>J</code>	Join the current line with the next one.
<code>x</code>	Delete the character at the current cursor position.
<code>X</code>	Delete the character before the current cursor position.
<code>dd</code>	Delete the current line putting it in the deletion buffer.
<code>p</code>	Insert (or paste) the text in the deletion buffer to just before the cursor position.
<code>u</code>	Undo the last command.
<code>/<i>text</i></code>	Scan forwards from the current cursor position for the nearest occurrence of <i>text</i> .
<code>?<i>text</i></code>	Scan backwards from the current cursor position for the nearest occurrence of <i>text</i> .
<code>n</code>	Repeat the last / or ? command.
<code>ZZ</code>	Save the current file and exit from <code>vi</code> .
<code>:wq Ret</code>	Save the current file and exit from <code>vi</code> .
<code>:q! Ret</code>	Exit from <code>vi</code> without saving the file.
<code>:w Ret</code>	Write the current file to disc.
<code>:w <i>filename</i> Ret</code>	Write the current file to disc using the specified filename.
<code>:s/<i>pattern</i>/<i>replace</i>/g Ret</code>	Substitute all occurrences of <i>pattern</i> in the current line by <i>replace</i> . It <code>g</code> is omitted only the first occurrence is replaced.
<code>:<i>n</i>,<i>ms</i>/<i>pattern</i>/<i>replace</i>/g Ret</code>	Perform the substitution on all lines between line numbers <i>n</i> and <i>m</i> .The last line number can be written as <code>\$</code> .

The `vi` editor has many more features, but the above selection is sufficient for most needs.

3.6 emacs

The `emacs` editor is highly sophisticated and much loved by many professional programmers and I recommend that you use it. You can use it effectively using a tiny minority of its available commands, and so it should not take long to learn. It is normally best to use `emacs` once you are in the graphics desktop, ie after you have executed the `startx` command immediately after logging in. So from now on I assume that you have started a graphics desktop session (using `startx`) and have opened an `LXTerminal` session, so that you can execute `bash` commands.

The Linux image you copied to your SD card probably did not include the `emacs` editor, so you will have to install it using `apt-get` or `synaptic`. Try typing:

```
sudo apt-get install emacs
```

If this works (and it should), you will be able to enter `emacs` by typing

```
emacs &
```

This will create a new window on the desktop for `emacs` to run in.

Before learning how to use `emacs`, I suggest you move to the next chapter and install the BCPL system. Once that is working come back here to see how to use `emacs` to edit files.

You should first set up some initialisation files so that `emacs` knows about BCPL mode which will automatically colour BCPL reserved words, strings, comments and other syntactic items appropriately. So, after installing BCPL, type:

```
cd
cp -r $BCPLROOT/Elisp .
cp $BCPLROOT/.emacs .
```

The next time you enter `emacs`, it will use BCPL mode when editing BCPL source files with extensions `.b` or `.h`. This makes BCPL source code much more readable.

As I said above, you can create an `emacs` window by typing the `emacs &` command. When the window appears, move the mouse to it and click to bring it into focus. Input from the keyboard will now be directed to `emacs`.

Many `emacs` commands require the Ctrl key to be held down. For instance, holding down Ctrl and pressing e will move the cursor to the end of the current line. We will use the notation C-e to denote this operation. To illustrate what `emacs` can do, we will edit the `hello.b` program in the `~/distribution/BCPL/cintcode/com/` directory. To edit this file, type C-x C-f and then type `~/distribution/BCPL/cintcode/com/hello.b` followed by Enter. This should put the following text (in colour) near the top of the window.

```
GET "libhdr"
```

```
LET start() = VALOF
{ writef("Hello World!*n")
  RESULTIS 0
}
```

The cursor position will be marked by a small flashing rectangle. The cursor can be moved UP, DOWN, LEFT and RIGHT using the arrow keys. It can also be moved to the end of the current line by typing C-e, and to the beginning of the current line by C-a. Use these keys to position the cursor over the `w` of `writef` and press C-k C-k. The first deletes (or kills) the text from the cursor position to the end of the line, and the second kills the newline character at the end of the line. The killed text is not lost but held in a stack of killed items. Type C-y will recover what has just been killed, and typing C-y again will recover it again. The text should now be as follows.

```
GET "libhdr"
```

```
LET start() = VALOF
{ writef("Hello World!*n")
  writef("Hello World!*n")
  RESULTIS 0
}
```

Move the cursor to the `w` of the second `writef` and press the space bar twice will correct the indentation. Now move the cursor to the `H` of the second `Hello World!` and press C-d 12 times to delete `Hello World!`. Now insert some text by typing: `How are you?.` The text should now be as follows.

```
GET "libhdr"
```

```
LET start() = VALOF
{ writes("Hello World!*n")
  writes("How are you?*n")
  RESULTIS 0
}
```

Now write this back to the file by typing C-s. To test that the editing was successful, click on the LXTerminal window and type: `cat com/hello.b`. It should output the edited version of the `hello.b` program. You can now compile and run it by typing:

```
cintsys
c bc hello
hello
```

The command `c` combines the file `bc` and the argument `hello` to form a command sequence that invokes the BCPL compiler to translate the source code `com/hello.b` into a form suitable for execution which it stores in `cin/hello`. You can inspect the source and compiled forms by typing the commands `type com/hello.b` and `type cin/hello`. Although at this stage the compiled form will be unintelligible. The file `bc` is called a command script and is one of many designed to make the BCPL cintcode system easier to use.

Now return to the `emacs` window by clicking on it. We can move the cursor to the start of the file by typing C-Shift-Home and the end by C-Shift-End. Now move to the start of the file (C-Shift-Home). If we want to find some text in the file type C-s followed by some characters such as `al` and observe how the cursor moves. You will see that the match ignores whether letters are in lower or upper case. If you press BkSp the cursor moves back to the `a` of `start` and pressing `r` will highlight the `ar` of `start`, and also the `ar` of `are`, two lines below. You can move to this word by either typing C-s again, or by increasing the length of our pattern by typing `e`. Pressing BkSp removes `e` from our pattern and returns the cursor to the just after the `r` of `start`. Just as C-s performs a forward search, C-r performs a backwards search. Practice using these commands until you are satisfied you can easily find anything you want in the file. To leave this interactive searching mode press Enter.

Suppose we wished to change every occurrence of `writeln` to `writes`. We could do this by pressing C-Shift-Home to get to the top of the file. Then press Esc followed by `%` to enter the interactive replacement command. It will invite you to type in the text you wish to replace, namely `writeln`. You terminate this by pressing Enter. It then invites you to give the replacement text, to which you type `writes` followed by Enter. This causes the first occurrence of `writeln` to be highlighted, waiting for a response. If you press the Space Bar it will replace this occurrence and move on to the next. If you press BkSp it will just move on to the next, and if you press Enter it will leave interactive replace mode.

The command C-g aborts whatever you were doing and returns you to the normal editing state. This turns out to be more useful than you might imagine.

A log of changes is kept by `emacs` and this is used by C-_ to undo the latest change. Multiple C-_s can undo several changes.

If you want to close the `emacs` window, type C-x C-c.

Splitting the screen is useful if you want to edit two files at the same time. To do this type C-x 2 and to return to a single screen type C-x 1. C-x 3 will split the screen vertically putting the sub-windows side by side.

There is a sophisticated online help facility. Type C-h to enter it. To find out what to do next, type ?. This will split the window into two parts filling the lower

half with a description of the possible help commands that are available. You can move the cursor into this sub-window by pointing the mouse into it and clicking. Alternatively, you can type `C-x o`. Once there, you can navigate through the help text using the same commands you use when editing a file.

To obtain a list of all key bindings type `C-h b`. If you scroll down to `C-x C-f` (or search for it) you will find it is bound to the `find-file` command. `C-h f find-file` will output a description of the command.

Although the commands I have described so far allows you to create and edit files, you will find exploring the `emacs` help system will allow you to use `emacs` even more effectively.

Chapter 4

The BCPL Cintcode System

The quick way to install the BCPL system is to download `bcpl.tgz` into your home directory (`/home/pi`) and then type the following sequence of commands.

```
cd
mkdir distribution
cd distribution
tar zxf ../bcpl.tgz
cd BCPL/cintcode
. os/linux/setbcplenv
make clean
make -f MakefileRaspi
c compall
```

```
cp -r Emacs $HOME          -- to configure emacs
cp .emacs $HOME            -- to configure emacs
```

But if you wish to understand what is going on, you should read the next section. But, while you are here, you might as well install the BCPL Cintpos systems as well. To do this, download `cintpos.tgz` into your home directory and then type the following.

```
cd
cd distribution
tar zxf ../cintpos.tgz
cd Cintpos/cintpos
make clean
make -f MakefileRaspi
c compall
logout
```

This is an interpretive implementation of the Tripos Portable Operating System which is described in the BCPL manual available from my home page.

4.1 Installation of BCPL

To install the BCPL System on the Raspberry Pi you must first obtain a copy of the file `bcpl.tgz` which is available via my home page (www.cl.cam.ac.uk/users/mr). Near the top of this page, under the heading “Shortcut to the main packages”, you will find a link to `bcpl.tgz`. Right clicking on this link should bring up a menu one of whose items will save `bcpl.tgz` as a file on your computer. If your Raspberry Pi is connected to the internet, you can do this using the Midori web browser and save to file in your home directory (`/home/pi`). Failing that, find a computer that has an SD card slot and is connected to the internet, and copy `bcpl.tgz` into `/home/pi` on your SD card. When you next login to the Raspberry Pi you will find `bcpl.tgz` in your home directory. To check it is there, run the following commands.

```
pi@raspberrypi:~$ cd
pi@raspberrypi:~$ pwd
/home/pi
pi@raspberrypi:~$ ls -l
-rwxrwx--- 1 pi pi 10300397 Apr 23 15:20 bcpl.tgz
pi@raspberrypi:~$
```

You can install BCPL anywhere you like but I would strongly recommend that the first time you install it you place it in exactly the same location that I use on my laptop since this will allow you to set the system up without having to edit any of the configuration files. I therefore suggest you follow the next few steps exactly.

1) Create a directory called `distribution`, make it the current directory and decompress the `tgz` file into it.

```
pi@raspberrypi:~$ mkdir distribution
pi@raspberrypi:~$ cd distribution
pi@raspberrypi:~/distribution$ tar zxvf ../bcpl.tgz
--- Lots of output showing the names of all files of the BCPL system
pi@raspberrypi:~/distribution$
```

2) List the contents of the current directory, the BCPL directory and `BCPL/cintcode`.

```

pi@raspberrypi:~/distribution$ ls
BCPL
pi@raspberrypi:~/distribution$ ls BCPL

bcplprogs cintcode Makefile natbcpl README TGZDATE xfiles
pi@raspberrypi:~/distribution$ ls BCPL/cintcode
--- Lots of files and directories including
g com sysb sysc os
pi@raspberrypi:~/distribution$

```

3) Now change to directory BCPL/cintcode and type the following commands.

```

pi@raspberrypi:~/distribution$ cd BCPL/cintcode
pi@raspberrypi:~/distribution/BCPL/cintcode$ . os/linux/setbcplenv
pi@raspberrypi:~/distribution/BCPL/cintcode$ make clean
pi@raspberrypi:~/distribution/BCPL/cintcode$ make -f MakefileRaspi
--- Lots of output showing the BCPL system being built
--- ending with something like:
bin/cintsys

```

```

BCPL Cintcode System (24 Jan 2012)
0.000>

```

The file `os/linux/setbcplenv` is a shell script that sets up BCPL environment variables such as `BCPLROOT` and `BCPLPATH` telling the system where BCPL has been installed. The important part of `setbcplenv` is as follows.

```

export BCPLROOT=$HOME/distribution/BCPL/cintcode
export BCPLPATH=$BCPLROOT/cin
export BCPLHDRS=$BCPLROOT/g
export BCPLSCRIPTS=$BCPLROOT/s

export POSROOT=$HOME/distribution/Cintpos/cintpos
export POSPATH=$POSROOT/cin
export POSHDRS=$POSROOT/g
export POSSCRIPITS=$POSROOT/s

export PATH=$PATH:$BCPLROOT/bin:$POSROOT/bin

```

When run using the dot (`.`) command, it defines the required shell environment variables and updates the `PATH` variable to include the `bin` directories where `cintsys` and `cintpos` live. `Cintpos` is a portable operating system implemented

in BCPL but not covered by this document. You can test whether the script has run correctly by typing `echo $BCPLROOT` or `printenv`.

You need to run this script every time you login to the Raspberry Pi if you want to use BCPL. It would therefore be useful for this to happen automatically every time you login. The `bash` shell runs some initialising shell scripts when it starts up, as is described in the manual pages generated by the `man bash` commands. Some of the scripts are provided by the system and live in the `/etc` directory but others live in the user's home directory. The possible file names are `.bash_profile`, `.bash_login`, `.profile` and possibly `.bashrc`. You can see which of these dot files are in your home directory by typing:

```
cd
ls -a
```

You should add the following line onto the end of one of these files.

```
. $HOME/distribution/BCPL/cintcode/os/linux/setbcplenv
```

On the version of Linux I am using on the Raspberry Pi, the script `.profile` calls `.bashrc`, and so I added the line to the end of the file `.bashrc`. To do this, I typed

```
cd
vi .bashrc
```

This caused me to get into the `vi` editor editing the file `.bashrc`. Now using the down-arrow key several times I got to the last line of the file and typed the lowercase letter `o`. This got me into input mode allowing me to add text to the end of the file. I then typed the line

```
. $HOME/distribution/BCPL/cintcode/os/linux/setbcplenv
```

terminated by pressing both the Enter and Esc keys. This returned me to edit mode. Finally I typed: `:wq` and pressed Enter, to write the edited file back to the filing system. To check that I edited the file correctly, I typed `cat .bashrc` and looked carefully at its last line.

After making this change to an appropriate script file, you should test it by logging out of the Raspberry Pi and login again. To logout, type

```
sudo shutdown -h now
```

But, if you are in the graphics environment, you should leave this first by clicking on the little red icon at the bottom right hand corner of the screen.

The next time you login to the Raspberry Pi, you should find that the BCPL environment variables have been defined automatically. To make sure, type: `echo $BCPLROOT`.

The commands `make clean` and `make -f MakefileRaspi` remove unwanted files and causes the entire BCPL Cintcode System to be rebuilt from scratch. This involves the compilation of several C programs and the BCPL compilation of every BCPL program in the system. The last line `0.000>` is a prompt from the BCPL Command Language Interpreter inviting you to type a command. If this all works you will now be in business and can begin to use BCPL.

As confirmation that the system really is working, type in the following commands.

```
0.000> echo hello
hello
0.000> type com/echo.b
SECTION "ECHO"

GET "libhdr"

LET start() = VALOF
{ LET tostream = 0
  LET toname = 0
  LET appending = ?
  LET nonewline = ?
  LET text = 0
  LET argv = VEC 80

  IF rdargs("TEXT,TO/K,APPEND/S,N/S", argv, 80)=0 DO
  { writes("Bad argument for ECHO*n")
    RESULTIS 20
  }

  IF argv!0 DO text := argv!0    // TEXT
  IF argv!1 DO toname := argv!1 // TO/K
  appending := argv!2           // APPEND/S
  nonewline := argv!3           // N/S

  IF toname DO
  { TEST appending
    THEN tostream := findappend(toname)
    ELSE tostream := findoutput(toname)
```

```

UNLESS tostream DO
{ writef("Unable to open file: %s*n", toname)
  result2 := 100
  RESULTIS 20
}
selectoutput(tostream)
}

```

```

IF text DO writes(text)
UNLESS nonewline DO newline()

```

```

IF tostream DO endstream(tostream)
RESULTIS 0
}

```

```
0.260> bcpl com/echo.b to junk
```

```

BCPL (1 Feb 2011)
Code size    244 bytes
0.130> junk hello
hello
0.020> bcpl com/bcpl.b to junk

```

```

BCPL (1 Feb 2011)
Code size    22156 bytes
Code size    12500 bytes
1.210> junk com/bcpl.b to junk

```

```

BCPL (1 Feb 2011)
Code size    22156 bytes
Code size    12500 bytes
1.210> logout

```

```
pi@raspberrypi:/distribution/BCPL/cintcode$
```

The `echo` command just outputs its argument. The `type` command outputs the BCPL source code of the `echo` command and the `bcpl` command compiles it into a file called `junk`. This is then executed as the `junk` command, demonstrating that it behaves exactly as the `echo` command did. Next we use the `bcpl` command to compile the BCPL compiler whose source code is in `com/bcpl.b`. This overwrites the file `junk` which is then used to compile the compiler again with identical effect. The prompt contains the time in seconds of the previous command, so we see that compiling the BCPL compiler takes a mere 1.2 seconds. The `logout` command

leaves the BCPL system and returns to the `bash` shell. To re-enter the BCPL system type the command `cintsys`.

If you plan to use the `emacs` editor (which I recommend) you should set up its initialisation files so that it knows about BCPL mode which will automatically colour BCPL reserved words, strings, comments and other syntactic items appropriately. To do this type:

```
cd
cp -r $BCPLROOT/Elisp .
cp $BCPLROOT/.emacs .
```

The next time you enter `emacs` it will use BCPL mode when editing BCPL source files with extensions `.b` or `.h`. This makes editing such files much more friendly.

We will now look at a few more Linux commands. The `bash` program looks up commands in a sequence of directories called a path. This sequence can be inspected by looking at the value of the `PATH` environment variable as shown by:

```
pi@raspberrypi:~$ echo $PATH
/usr/local/sbin:/usr/local/bin:/usr/sbin:/usr/bin:/sbin:/bin:
/home/pi/distribution/BCPL/cintcode/bin:
/home/pi/distribution/Cintpos/cintpos/bin:
```

You can output an entire file to the screen by commands such as `cat com/echo.b` or you can display it one page at a time using `more` as in `more com/type.b`. The `more` program can be controlled using the Space bar, Enter key, the arrow key, `p` and `b` and many others. To quit the program type `q`.

The `cp` command copies files. For instance, `cp com/abort.b prog.b` will copy the source of the `abort` command into the current directory as file `prog.b`. You can also use `cp` to copy complete directory trees using the `-r` argument, as in `cp -r g myg`. You can test it worked by typing `ls myg`.

The `rm` command removes files as in `rm myg/libhdr.h`. It can also remove complete directory trees using the `-r` argument, as in `rm -r myg`.

We are now ready to learn how to program in BCPL and this will be done in a gentle way exploring the simple programs presented below.

4.2 Hello World

The BCPL system contains a huge number of BCPL programs that can be found in directories such as

```
~/distribution/BCPL/cintcode/com      The commands
~/distribution/BCPL/cintcode/sysb    The system programs
~/distribution/BCPL/bcplprogs/demos  Some demo files
~/distribution/BCPL/bcplprogs/raspi  The programs described here
```

You are certainly free to look at these, but it is probably best to start with some simple examples. Ever since Brian Kernighan wrote the first Hello World program in an internal Bell Laboratory memorandum about B in the mid 1970s, it has become the standard first program used in the description of most programming languages. The version for BCPL is `com/hello.b` and is as follows:

```
GET "libhdr"

LET start() = VALOF
{ writef("Hello World!*n")
  RESULTIS 0
}
```

The line `GET "libhdr"` inserts a file declaring all sorts of library functions, variables and constants needed by most programs. The actual file inserted is `cintcode/g/libhdr.h` but there is no need to look at it yet. The next line is the heading of a function called `start` which, by convention, is the first function of a program to be executed. The body of `start` is a `VALOF` block that contains commands to be executed terminated by a `RESULTIS` command that specifies the result. In this case a result of zero indicates that the `hello` program terminated successfully. But before returning, it executes `writef("Hello World!*n")` which output the characters `Hello World!` followed by a newline (represented by the escape sequence `*n`).

This program can be compiled using the `bcpl` command to form a compiled program called `junk` which is then executed.

```
0.000> bcpl com/hello.b to junk

BCPL (1 Feb 2011)
Code size = 60 bytes
0.100>
0.000> junk
Hello World!
0.020>
```

Compiled commands are normally placed in a directory called `cin`, and, for convenience, there is a script called `bc` to simplify the compilation of such commands. If we regard `hello.b` as a command, it can be compiled using the `c bc hello` command as follows.

```
0.030> c bc hello
bcpl com/hello.b to cin/hello hdrs BCPLHDRS
```

```
BCPL (1 Feb 2011)
Code size =    60 bytes
0.130>
```

The `hello` command can now be executed.

```
0.000> hello
Hello World!
0.020>
```

The script file `bc` is as follows

```
#!/home/mr/distribution/BCPL/cintcode/cintsys -s
.k file/a,arg
echo "bcpl com/<file>.b to cin/<file> hdrs BCPLHDRS <arg>"
bcpl com/<file>.b to cin/<file> hdrs BCPLHDRS <arg>
```

But at this stage there is no need to understand how it works.

For convenience, all the BCPL programs covered in this document can be found in the directory `BCPL/bcplprogs/raspi` of the standard BCPL distribution. If you make this your current directory, you can inspect, compile and run these programs using commands such as the following.

```
pi@raspberpi:~$ cd ~/distribution/BCPL/bcplprogs/raspi
pi@raspberpi:~/distribution/BCPL/bcplprogs/raspi$ cintsys
```

```
BCPL Cintcode System (24 Jan 2012)
0.000> type hello.b
GET "libhdr"
```

```
LET start() = VALOF
{ writef("Hello World!*n")
  RESULTIS 0
}
0.020> c b hello
bcpl hello.b to hello hdrs BCPLHDRS
```

```
BCPL (1 Feb 2011)
```

```
Code size =    60 bytes
0.130>
0.000> hello
Hello World!
0.020>
```

The command script `b` used here is similar to `bc` used earlier by expects the source program to be in the current directory and place the compiled version in the same directory.

The next program we will study concerns the Fibonacci sequence of numbers.

4.3 Fibonacci

Leonardo Fibonacci lived in Italy near Pisa dying in about 1250 AD aged around 80. He is regarded by some as “the most talented western mathematician of the Middle Ages”. He is perhaps best known for the sequence of numbers named after him. This sequence has some extraordinary properties and has excited mathematicians ever since. The sequence starts as follows: 0, 1, 1, 2, 3, 5, 8, 13, 21,... with every number being the sum of the preceding two. For instance 2+3 gives 5, and 3+5 gives 8 etc. These numbers can be given positions with the convention that the first in the sequence is at position zero. The following table shows the positions and values of the first few numbers in the sequence.

position	0	1	2	3	4	5	6	7	8
value	0	1	1	2	3	5	8	13	21

A program to print out the positions and values of some numbers in this sequence is called `fib1.b` and is shown in Figure 4.1. Text between `//` and the end of the line is called a comment and is designed to help the reader understand what is going on. Comments have no effect on the meaning of a program and are ignored by the compiler. This program can be compiled and run as follows.

```
0.020> c b fib1
bcpl fib1.b to fib1 hdrs BCPLHDRS

BCPL (1 Feb 2011)
Code size =    168 bytes
0.030> fib1
Position 0  Value 0
Position 1  Value 1
Position 2  Value 1
0.010>
```

```
GET "libhdr"

LET start() = VALOF
{ LET a = 0 // a and b hold two consecutive Fibonacci numbers
  LET b = 1
  LET c = a+b // c holds the Fibonacci number after b, namely a+b
  LET i = 0 // The position of the Fibonacci number held in a

  writef("Position %n Value %n*n", i, a)
  a := b
  b := c
  c := a+b
  i := i+1

  writef("Position %n Value %n*n", i, a)
  a := b
  b := c
  c := a+b
  i := i+1

  writef("Position %n Value %n*n", i, a)
  a := b
  b := c
  c := a+b
  i := i+1

  RESULTIS 0
}
```

Figure 4.1: The file `fib1.b`

At the beginning of the body of the function `start` we see the declaration `LET a = 0`. This allocates space in the memory of the computer which you can think of as a pigeon hole which can hold a number. It has the name `a` and is initialised with the number zero. Similarly, `LET b = 1` allocates a pigeon hole for `b` initialised to 1. The third declaration `LET c = a+b` allocates a pigeon hole for `c` initialising it to the sum of the numbers in `a` and `b`. From now on, rather than talking about pigeon holes, we will usually describe them as variables with names `a`, `b` and `c`. They are called variables because, during the execution of the program, their values change. Indeed, as this program progresses, they are going to be successively set to three consecutive Fibonacci numbers further down the sequence. Initially, they hold the first three Fibonacci numbers (0, 1, 1)

with `a` holding the number at position zero. The declaration `LET i = 0` declares variable `i` to hold the position of the Fibonacci number in `a`. The statement

```
writef("Position %n Value %n*n", i, a)
```

outputs a line with the substitution items `%n` replaced by the numbers in variables `i` and `a`. It thus outputs the following.

```
Position 0 Value 0
```

We now want to move on the next position in the sequence, and so we set `a` and `b` to the values currently in `b` and `c`. This is done by the assignments `a := b` and `b := c`, being careful to do these assignments in that order. We then compute the new value of `c` using `c := a+b` which essentially says: take the numbers in variables `a` and `b`, add them together and put the result in `c`. The numbers now in `a`, `b` and `c` are the three consecutive Fibonacci numbers starting at position 1. To set `i` to this new position number, we execute the statement `i := i+1` which increments `i` changing it from zero to one.

The program then executes exactly the same code two more times, outputting the following:

```
Position 1 Value 1
Position 2 Value 1
```

Finally, it executes `RESULTIS 0` causing the program to return from `start` successfully.

This program is not well written and can be improved in many ways. Its most obvious problem is that part of the program is written out three times and we should be able to find a way of writing this part once, and somehow arrange for it to be executed three times. The following code does just this.

```
GET "libhdr"
```

```
LET start() = VALOF
```

```
{ LET a = 0 // a and b hold two consecutive Fibonacci numbers
  LET b = 1
  LET c = a+b // c holds the Fibonacci number after b, namely a+b
  LET i = 0 // The position of the Fibonacci number held in a
```

```
  WHILE i<=2 DO
```

```
  { writef("Position %n Value %n*n", i, a)
    a := b
    b := c
```

```

        c := a+b
        i := i+1
    }

    RESULTIS 0
}

```

Here the `WHILE` statement repeatedly executes its body so long as the value of `i` remains less than or equal to 2. This kind of loop is so common that many languages allow it to be coded even more compactly. Such as the following.

```

{ LET a = 0 // a and b hold two consecutive Fibonacci numbers
  LET b = 1
  LET c = a+b // c holds the Fibonacci number after b, namely a+b

  FOR i = 0 TO 2 DO
  { writef("Position %n Value %n*n", i, a)
    a := b
    b := c
    c := a+b
  }

  RESULTIS 0
}

```

The `FOR` loop declares `i` with initial value 0, and then it repeatedly executes its body, incrementing `i` each time. This version is both more concise and more understandable.

Finally, the variable `c` is only needed very briefly when we are calculating the new value of `b`. We do not need to remember its value between iterations of the body, and so it can be declared inside the `FOR` loop. At the same time we can replace the separate declarations of `a` and `b` by a single simultaneous declaration. The resulting program is as follows.

```

GET "libhdr"

LET start() = VALOF
{ LET a, b = 0, 1 // a and b hold two consecutive Fibonacci numbers

  FOR i = 0 TO 2 DO
  { LET c = a+b // c holds the Fibonacci number after b, namely a+b
    writef("Position %n Value %n*n", i, a)
  }
}

```

```

    a := b
    b := c
}

RESULTIS 0
}
```

The declaration `LET c = a+b` is placed at the head of the block (enclosed within `{ }` brackets) since such declarations are only permitted at the start of a block. An obvious advantage of this form of the program is that we can now easily change it to output the sequence up to, say, position 20.

```

GET "libhdr"

LET start() = VALOF
{ LET a, b = 0, 1 // a and b hold two consecutive Fibonacci numbers

  FOR i = 0 TO 20 DO
  { LET c = a+b // c holds the Fibonacci number after b, namely a+b
    writef("Position %n Value %n*n", i, a)
    a := b
    b := c
  }

  RESULTIS 0
}
```

This gives the following output.

```

0.010> c b fib4
bcpl fib4.b to fib4 hdrs BCPLHDRS

BCPL (1 Feb 2011)
Code size = 92 bytes
0.020> fib4
Position 0 Value 0
Position 1 Value 1
Position 2 Value 1
Position 3 Value 2
Position 4 Value 3
Position 5 Value 5
...
```



```

Position 15 Value 610
Position 16 Value 987
Position 17 Value 1597
Position 18 Value 2584
Position 19 Value 4181
Position 20 Value 6765
0.000>

```

The final improvement could be to arrange that the position numbers are printed in a field width of 2 and the values in a field width of, say, 12. We do this by changing the `writeln` statement from

```
writeln("Position %n Value %n*n", i, a)
```

to

```
writeln("Position %2i Value %12i*n", i, a)
```

The effect is as follows.

```

Position 0 Value          0
Position 1 Value          1
Position 2 Value          1
Position 3 Value          2
Position 4 Value          3
Position 5 Value          5
...
Position 15 Value         610
Position 16 Value         987
Position 17 Value        1597
Position 18 Value        2584
Position 19 Value        4181
Position 20 Value        6765

```

We have just seen that we can perform quite complicated calculations just using simple variables, assignments, the plus operator and `WHILE` loops. If we allow subtraction as well, we can calculate almost anything we like, such as, for example, the n^{th} prime number. A prime number is only divisible by 1 and itself. The first few primes are 2, 3, 5, 7, 11 and 13. The following program outputs the 100th prime.

```
GET "libhdr"
```

```
LET start() = VALOF
```

```

{ LET n = 100 // The number of the prime we want
  LET p = 2 // The current number we are looking at
  LET count = 0 // The count of how many primes we have found

  { // Start of the main loop
    // Test whether p is prime
    // Let us assume it is prime unless proved otherwise
    LET p_is_prime = TRUE
    // Try dividing it by all numbers between 2 and p-1

    FOR d = 2 TO p-1 DO
    { // d is the next divisor to try
      // We test to see if d divides p exactly
      LET r = p // Take a copy of p
      // Keep subtracting d until r is less than d
      UNTIL r < d DO r := r - d
      // If r is now zero, d exactly divides p
      // and so p is not prime
      IF r=0 DO
      { p_is_prime := FALSE
        BREAK // Break out of the FOR loop
      }
    }
  }

  IF p_is_prime DO
  { // We have found a prime so increment the count
    count := count + 1
    IF count = n DO
    { // We have found the prime we were looking for,
      // so print it out,
      writef("The %nth prime is %n*n", n, p)
      // and stop.
      RESULTIS 0
    }
  }
  // Test the next number
  p := p+1
} REPEAT
}

```

This program uses special numbers TRUE (=1) and FALSE (=0) to represent truth values. It uses an IF statement to conditionally execute some code, and it uses a BREAK command to break out of the FOR loop. The word REPEAT causes

the preceding command to be executed repeatedly. In this program the loop is terminated by `RESULTIS 0` after the n^{th} prime has been output. It is terribly inefficient but it does compute the correct result on the Raspberry Pi in very little time, as can be seen below.

```
0.000> c b prime1
bcpl prime1.b to prime1 hdrs BCPLHDRS

BCPL (1 Feb 2011)
Code size = 124 bytes
0.110> prime1
The 100th prime is 541
0.080>
```

If you successively change `n` to 1000, 2000 and 4000 you will find the time to compute these primes increases by nearly a factor of 5 each time. It seems to grow faster than n^2 (this stands for $n \times n$, so when n doubles the cost goes up by a factor of 4) but less fast than n^3 (this stands for $n \times n \times n$, so every time n doubles the cost goes up by a factor of 8). Such programs are said to have *polynomial complexity*, and one of the challenges in programming is to find ways of computing the required result much more efficiently.

If you think polynomial complexity is bad, *exponential complexity* is far worse (but sometimes useful). This is when the computation time grows at a rate of similar to k^n (every time n is increased by 1 the cost goes up by a factor of k). One problem that is thought to have exponential complexity is the following. Given an n digit decimal number, x say, that is known to be the product of two primes, find them. In a sense this is easy – just try dividing by every number between 2 and $x - 1$. Unfortunately, there are roughly 10^n to try and if n is more than about 500 it is likely to take longer than the life time of the universe to solve.

Coming back to our n^{th} prime program, we can speed it up quite a bit using additional operators available in BCPL, in particular the `MOD` operator that computes the remainder after division of one number by another. For instance `13 MOD 5 = 3`. Using the `MOD` operator the program becomes:

```
GET "libhdr"

LET start() = VALOF
{ LET n = 100 // The number of the prime we want
  LET p = 2 // The current number we are looking at
  LET count = 0 // The count of how many primes we have found
```

```

{ // Start of the main loop
  // Test whether p is prime
  // Let us assume it is prime unless proved otherwise
  LET p_is_prime = TRUE
  // Try dividing it by all numbers between 2 and p-1

  FOR d = 2 TO p-1 DO
  { // d is the next divisor to try
    // We test to see if d divides p exactly
    LET r = p MOD d
    // If r is zero, d exactly divides p
    // and so p is not prime
    IF r=0 DO
    { p_is_prime := FALSE
      BREAK // Break out of the FOR loop
    }
  }
}

IF p_is_prime DO
{ // We have found a prime so increment the count
  count := count + 1
  IF count = n DO
  { // We have found the prime we were looking for,
    // so print it out,
    writef("The %nth prime is %n*n", n, p)
    // and stop.
    RESULTIS 0
  }
}
// Test the next number
p := p+1
} REPEAT
}

```

4.4 Multiplication Table

The following simple program (bcplprogs/raspi/multab.b) outputs the 12x12 multiplication table.

```
GET "libhdr"
```

```

LET start() = VALOF
{ FOR x = 1 TO 12 DO
  { newline()
    FOR y = 1 TO 12 DO writef(" %i3", x*y)
  }
  newline()
  RESULTIS 0
}

```

The output it generates is as follows

1	2	3	4	5	6	7	8	9	10	11	12
2	4	6	8	10	12	14	16	18	20	22	24
3	6	9	12	15	18	21	24	27	30	33	36
4	8	12	16	20	24	28	32	36	40	44	48
5	10	15	20	25	30	35	40	45	50	55	60
6	12	18	24	30	36	42	48	54	60	66	72
7	14	21	28	35	42	49	56	63	70	77	84
8	16	24	32	40	48	56	64	72	80	88	96
9	18	27	36	45	54	63	72	81	90	99	108
10	20	30	40	50	60	70	80	90	100	110	120
11	22	33	44	55	66	77	88	99	110	121	132
12	24	36	48	60	72	84	96	108	120	132	144

Many will recognise this as the horrendous collection of 144 numbers one had to learn, often by rote, at school. Some readers will still be in the process of learning them. I have two reasons for giving this example. The first is that this program can be easily modified to output tables for other expression operators. For instance, try replacing the expression `x*y` in the `writef` statement by each of `x/y`, `x MOD y`, `x+y`, `x-y`, `x&y`, `x|y`, `x XOR y`, and even `x=y` or `x<y`. All these operators are described later. The second reason is that learning 144 numbers can be boring and there are a whole collection of simple tricks that help you work out the answer to any of these multiplications.

4.5 A Mathematician's Approach

This section is entirely optional but the mathematics it contains is both simple and useful, so I recommend you only skip this section when you have had enough.

Rather than remembering a multitude of results, mathematicians tend to like to work things out from first principles. We all know that $5 \times 9 = 45$, but our memory is not always perfect and we might accidentally think $5 \times 9 = 54$ and have little to help us recognise that we have the wrong answer. A mathematician

looking 5×9 thinks of the cunning ways of multiplying by 5 and by 9. For instance, $9 = 10 - 1$, so $5 \times 9 = 5 \times (10 - 1) = 50 - 5 = 45$. Since multiplication by 10 is easy as is subtracting 5, there can be little chance of error. Another thought is that $5 = \frac{10}{2}$, so $5 \times 9 = 5 \times (8 + 1) = 5 \times 8 + 5 = 10 \times 4 + 5 = 45$. These are applications of two rules that I have named X9 and X5 and there are many other helpful rules as shown in Figure 4.2.

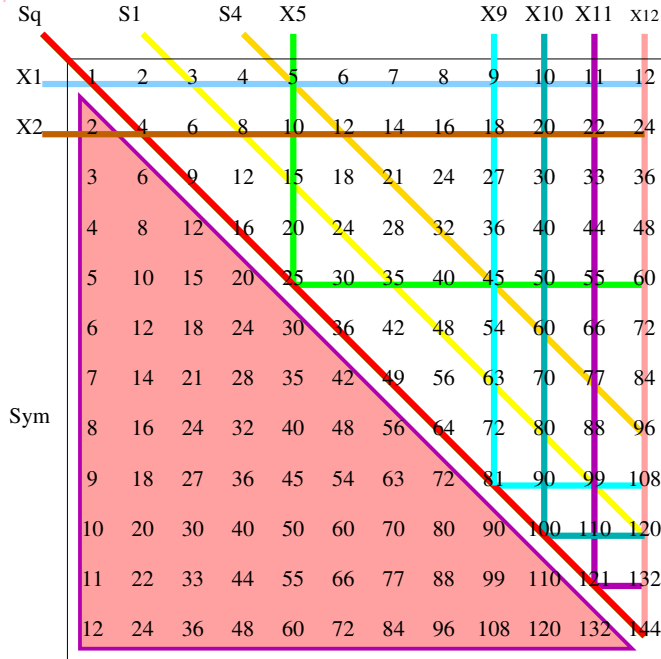

Figure 4.2: Multiplication Table

The rules are as follow.

Sym

We all know that $2 \times 3 = 3 \times 2$ and $5 \times 4 = 4 \times 5$, that is we can swap the order of the operands of the multiplication without changing the result. This rule can be stated algebraically as follow.

$$x \times y = y \times x$$

where x and y can be replaced by any numbers we like. The immediate effect of this rule is that we do not need to learn the 66 values in the bottom left triangle since they all appear in the upper right hand triangle.

X1

The top row of the table is trivial since it corresponds to the one times table. Its entries, such as $1 \times 5 = 5$, are so obvious they hardly need to be learnt. The algebraic rule is as follows.

$$1 \times x = x$$

X2

This corresponds to the two times table. It is easy to remember that $2 \times 2 = 4$. We have 5 fingers on each hand making 10 in all, so $2 \times 5 = 10$ is not a problem. We can surely remember that $2 \times 10 = 20$ and there are rules (**X9**, **X11** and **X12**) to help with multiplication by 9, 11 and 12. So we really only have to learn $2 \times 3 = 6$, $2 \times 4 = 8$, $2 \times 6 = 12$, $2 \times 7 = 14$ and $2 \times 8 = 16$. The result of multiplying by two is called an even number and always has a 0, 2, 4, 6 or 8 in the units position, and so is easy to recognise.

X10

Multiplication by ten is easy since it just requires a zero to be placed on the end of the number, as is $10 \times 6 = 60$ or $10 \times 12 = 120$. We could possibly write this rule as follows.

$$10 \times x = x0$$

X11

Multiplication by eleven can be simplified by observing that $11 = (10 + 1)$, so that, for instance, $11 \times 6 = (10 + 1) \times 6 = 60 + 6 = 66$. The rule is thus:

$$11 \times x = 10x + x$$

Notice that when x is a single digit, it is duplicated, as in $11 \times 4 = 44$, but when it is 10, 11 or 12 a simple addition is required, as in $11 \times 10 = 100 + 10 = 110$, $11 \times 11 = 110 + 11 = 121$ and $11 \times 12 = 120 + 12 = 132$. These are easy since no carries are required.

X9

Multiplication by nine can be simplified by observing that $9 = (10 - 1)$, so that, for instance, $9 \times 6 = (10 - 1) \times 6 = 60 - 6 = 54$. The rule is thus:

$$9 \times x = 10x - x$$

X12

Multiplication by twelve can be simplified by observing that $12 = (10 + 2)$, so that, for instance, $12 \times 6 = (10 + 2) \times 6 = 60 + 12 = 72$. The rule is thus:

$$12 \times x = 10x + 2x$$

Multiplying x by ten and two are trivial and adding the two results is easy because the units digit will be the units digit of $2x$ and the senior two digits will be the result of adding 0, 1 or 2 into the ten position of $10x$, as in $12 \times 7 = 70 + 14 = 84$ or $12 \times 9 = 90 + 18 = 108$.

X5

Computing $5 \times x$ can be simplified by observing that $5 = \frac{10}{2}$. The rule has two versions depending on whether x is even or odd.

If x is even it can be written as $2n$ and the rule is

$$5 \times x = \frac{10}{2} \times 2n = 10 \times n$$

For example, $5 \times 8 = 10 \times 4 = 40$

If x is odd it can be written as $2n + 1$ and the rule is

$$5 \times x = 5 \times (2n + 1) = 10 \times n + 5$$

For example, $5 \times 7 = 5 \times 6 + 5 = 30 + 5 = 35$

Sq

Perfect squares are important and should be learnt. All except, 3^2 , 4^2 , 6^2 , 7^2 and 8^2 have been covered by rules given above. $3^2 = 9$ is easy to remember since it is just three groups of three as in 123 456 789. $4 \times 4 = 2 \times 8$ which equals 16 from the two times table. Observing that $6 = (5 + 1)$ suggests the $6 \times 6 = (5 + 1) \times 6 = 5 \times 6 + 6 = 30 + 6 = 36$. 7×7 is a problem. Perhaps we should just remember that it is 49, or observe that $7 \times 7 = 6 \times 7 + 7 = 42 + 7 = 49$. Finally $8 \times 8 = 2 \times 4 \times 8 = 2 \times 32 = 64$. Since 8 is 2^3 , $8^2 = 2^6$ and so is a power of two. Powers of two (1, 2, 4, 8, 16, 32, 64, 128, 256, ...) are important to computer scientists since computers use the binary system. These powers are etched into most computer scientist's brains, as are $2^{10} = 1024$, $2^{12} = 4096$, 2^{20} is about a million and 2^{30} is about a thousand million.

S1

If you stare at the multiplication table long enough you will notice that

$$\begin{aligned} 4 \times 6 &= 24 = 5^2 - 1 \\ 5 \times 7 &= 35 = 6^2 - 1 \\ 6 \times 8 &= 48 = 7^2 - 1 \\ 7 \times 9 &= 63 = 8^2 - 1 \end{aligned}$$

and so on. This is no accident because it follows from

$$(x - 1) \times (x + 1) = (x - 1) \times x + (x - 1) = x^2 - x + x - 1 = x^2 - 1$$

ie

$$(x - 1) \times (x + 1) = x^2 - 1$$

So the product of two numbers that differ by two is one less than the square of the number between them.

S4

The **S1** rule can easily be generalised to

$$(x - y) \times (x + y) = x^2 - y^2$$

If we set $y = 2$ this becomes

$$(x - 2) \times (x + 2) = x^2 - 4$$

as in

$$\begin{aligned} 3 \times 7 &= 5^2 - 4 = 25 - 4 = 21 \\ 4 \times 8 &= 6^2 - 4 = 36 - 4 = 32 \end{aligned}$$

This rule is not particularly useful but it does lead to one observation. The larger the value of y the smaller the product. So if you knew that 7×8 and 6×9 were 56 and 54, or possibly the other way round. Since 6×9 must be smaller than 7×8 , 6×9 must have the smaller value, namely 54.

4.6 Numbers

The programs we have looked at so far involved numbers that were held in variables or named pigeon holes. This section explores how such numbers are represented within the computer.

Humans have always used numbering systems based on 10, presumeable because we have 10 fingers. Even in the roman numbering system, 10 is special. For instance, single letters are used for 10 (X), 100 (C) and 1000 (M). Although the Roman numbering system is rather elegant and often used on clock faces (I, II, III, IV, V, VI, VII, VIII, IX, X, XI and XII) it is not convenient for numerical calculation. Consider, for example, adding 16 to 57. In roman numerals we would have to add XVI to DVII giving DXXIII (or 73). In China, India and the Arab world the advantages of multiple digits to represent numbers were well known 3000 years ago but not used in the west until much later. They also discovered the need for the digit zero which had previously not existed. Arithmetic calculations were sometimes done using pebbles placed in holes in the ground and the symbol 0 used to represent zero is thought to be a picture of a hole containing no pebbles.

Fibonacci was one of the first mathematicians in the west to study the advantages of the system we now use. We all know how to add 16 to 57. We first add 6 to 7 giving the answer 3 in the units position and carry of 1 to the tens position. We then add this carry to 1 and 5 giving 7, resulting in the answer 73. Humans are happy with the idea of 10 digits (0 to 9) but computers are much easier to design if only two digits (0 and 1) are available. Typically, in electronic circuits, 0 is represented by a low voltage possibly about 0 volts, and one is represented by a higher voltage of possibly about 3 volts. Numbers using only the digits zero and one are binary numbers. They are like decimal numbers but their digit positions correspond to powers of 2 (1, 2, 4, 8, 16,...) rather powers of 10 (1, 10, 100, 1000,...) used in the decimal system. Using three digit binary numbers, we can count from 0 to 7 as follows: 000, 001, 010, 011, 100, 101, 110, 111. In BCPL, on the Raspberry Pi, numbers are represented using 32 binary digits (or bits) rather than the three just shown. So rather than just eight different numbers, a BCPL variable can have huge number of different values (actually rather more the 4000 million of them). This sounds like a lot and usually causes no problems. But if you write a program that requires numbers outside this range, unexpected things happen. For instance, if we modify the Fibonacci program

above to output Fibonacci numbers up to position 50 and modify the `writeln` statements to be:

```
writeln("Position %2i Value %12u %32b*n", i, a, a}
```

The `%12u` substitution item outputs the Fibonacci number as an unsigned (ie ≥ 0) number in a field width of 12 characters and `%32b` outputs it as a 32-bit binary number. The resulting output is:

```
Position 0 Value      0 00000000000000000000000000000000
Position 1 Value      1 000000000000000000000000000000001
Position 2 Value      1 000000000000000000000000000000001
Position 3 Value      2 000000000000000000000000000000010
Position 4 Value      3 000000000000000000000000000000011
Position 5 Value      5 0000000000000000000000000000000101
Position 6 Value      8 0000000000000000000000000000000100
...
Position 45 Value 1134903170 01000011101001010011111110000010
Position 46 Value 1836311903 01101101011100111110010101011111
Position 47 Value 2971215073 10110001000110010010010011100001
Position 48 Value  512559680 00011110100011010000101001000000
Position 49 Value 3483774753 11001111101001100010111100100001
Position 50 Value 3996334433 11101110001100110011100101100001
```

Notice that the value at position 6 is 8 which is the sum of 3 and 5. In binary, the calculation is `0011+0101` giving `1000`. The value at position 47 is correct, but after that the Fibonacci numbers are too large to be represented with just 32 bits, and digits off the left hand end are lost. This unfortunate effect is called overflow and some languages generate a warning when this happens, but not BCPL. BCPL assumes that programmers are really clever and careful and don't need such warnings which, in any case, greatly complicates the definition of the language.

We have seen that decimal constants such as 2 and 100 can be written in the normal way, but BCPL also allows binary constants by prefixing a string of binary digits with `#b`, as in `#b0011` and `#b0101`. It is sometimes helpful to put underscores in long numbers to make them more readable. For instance, the binary representation of the Fibonacci number at position 47 could be written as:

```
#b1011_0001_0001_1001_0010_0100_1110_0001
```

This can also be written as a more concisely using the hexadecimal digits 0, 1, 2, 3, 4, 5, 6, 7, 8, 9, A, B, C, D, E and F, as follows:

```
#xB11924E1
```

Each hexadecimal digit represent 4 binary digits, so, for instance, `#xB` means `#b1011` and `#xB1` means `#b10110001`, etc.

In binary numbers the values associated with the digits, taken from the right (or least significant end) are 1, 2, 4, 8, 16, ... or $2^0, 2^1, 2^2, 2^3, 2^4, \dots$. Following this convention the left most bit of a 32-bit binary number corresponds to the value 2^{31} which is, of course, a positive number. Unsigned numbers use this convention, but if we want to represent positive and negative numbers, the normal convention to use is to assign a value of -2^{31} to the left most bit. This allows us to have numbers roughly in the range -2000 million to +2000 million. Notice that `#x80000000` represents the largest negative number, `#xFFFFFFFF` represents the number -1 and `#x7FFFFFFF` represents the largest positive number.

The representation of -1 perhaps needs some explanation. With a decimal numbers such as 9999, we all know how to increment it by one. During the calculation there is a cascade of carries before producing the answer 10000. So a string of consecutive nines on the right are converted to zeroes. A similar cascading effect happens when we increment a binary number having a sequence of ones on the right. Just as nine is the largest decimal digit, one is the largest binary digit, so when incrementing the digit one it turns into a zero and generates a carry. If we add one to the binary number 1111, there is a cascade of carries before giving the result 10000. If we add one to the binary number consisting of a zero bit followed by 31 ones (`#x7FFFFFFF`) we get a one followed by 31 zeroes (`#x80000000`). In unsigned arithmetic this correctly represents the value 2^{31} .

In signed arithmetic, this result represents -2^{31} and so the calculation has overflowed, so `#x7FFFFFFF` must be the largest positive number than can be represented. If we increment a bit pattern of 32 ones (`#xFFFFFFFF`), using signed arithmetic, all the least significant ones are turn to zeroes and the left most bit also changes from a one to a zero. This gives the correct answer since the carry into the left most bit represents 2^{31} and this cancels the one that is there representing -2^{31} correctly giving a zero bit in this position. Thus adding one to `#xFFFFFFFF` gives zero, and so `#xFFFFFFFF` must represent -1 .

We have already seen the operators `+`, `-` and `MOD` used in programs given above, but several other expression operators available. The operator `*` will multiply its operands together as in `3*7` gives 21. The operator `/` divides its left hand operand by the one on the right, as in `13/5` gives 2. Notice that the result is a whole number and the remainder, if any, is thrown away. The remainder after division can be obtained using the `MOD` operator, as in `13 MOD 5` which gives 3. If we do ordinary arithmetic using operators like `+`, `-` and `*` but always return the remainder after division by some number, often called the modulus, then we are doing what is called *modulo* arithmetic. We will see useful applications of modulo arithmetic later.

A value can be negated using `-` as a monadic operator, as in `-x`. If `x` was 1000 then the result would be -1000. The monadic operator `ABS` negates its operand if it was negative, but leaves it unchanged if it was positive. Thus, `ABS (-1000)`

and `ABS 1000` both give 1000.

There are various operators that manipulate bit patterns directly. For instance, `x<<n` will shift the value of `x` left by the number of bits specified by `n`. Bits are lost off the left hand end and vacated positions on the right are filled with zeroes. The expression `x>>n` similarly computes `x` shifted right by `n` bit positions, filling vacated positions with zeroes. The operators `&` and `|` perform the logical bit-wise operations of *and* and *or*. For *and*, the n^{th} bit of the result is only a one if the n^{th} bit of both operands are ones, as in `#b0011 & #b1010` gives `#b0010`. For *or*, the n^{th} bit of the result is only a zero if the n^{th} bit of both operands are zeros, as in `#b0011 | #b1010` gives `#b1110`. The monadic operator `~` complements each bit of its operand to give the result. You might like to convince yourself that $(\sim x)+1 = -x$. The XOR operator computes a result in which the n^{th} bit is only a one if the corresponding bits of its two operands are different, as in `#b0011 XOR #b1010` gives `#b1001`.

Two little tricks are worth noting. If we subtract one from a variable `x` we get a bit pattern identical to `x` except the consecutive zero bits on the right have all changed to ones, and the rightmost occurring one has changed to a zero. If we then *and* this with the original value of `x` we obtain a bit pattern with the right most occurring one removed. For example:

<code>x</code>	<code>0101_1101_0011_1010_0000_0110_0000_0000</code>
<code>x-1</code>	<code>0101_1101_0011_1010_0000_0101_1111_1111</code>
<hr style="border: 0.5px solid black;"/>	
<code>x & (x-1)</code>	<code>0101_1101_0011_1010_0000_0100_0000_0000</code>

Similarly, if we compute `x & (-x)`, we obtain a bit pattern which is all zeroes except for a one in the position of the right most one in `x`. For example:

<code>x</code>	<code>0101_1101_0011_1010_0000_0110_0000_0000</code>
<code>-x</code>	<code>1010_0010_1100_0101_1111_1010_0000_0000</code>
<hr style="border: 0.5px solid black;"/>	
<code>x & (-x)</code>	<code>0000_0000_0000_0000_0000_0010_0000_0000</code>

Many other bit manipulations require cunning to do them efficiently. For instance, how can we find the most significant occurring one, or count the number of ones in a bit pattern. If you are interested in these kinds of problems look at the programs in `bcplprogs/bits`.

4.7 Applications of XOR and MOD

If you do not feel up it skip this section and the next, but, trust me, you might find it interesting.

Cryptography is the science of encoding secret messages in a way which allows only the intended recipient to decode them. Many methods involve

the use of a shared secret key known by both the sender and receiver but unknown to everyone else. Suppose the sender and receiver agree that the shared secret key is the 32 bit word `#x87654321` and the message to be sent is `#x0ABCDEF0`. The sender could encode the message using the XOR operator to combine the key with the message to give the encrypted message `#x8DD99DD1` ($= \text{\#x87654321 XOR \#x0ABCDEF0}$). This has complemented some of the bits in the binary representation of the message, and the receiver can complement the same bits by computing `#x87654321 XOR #x8DD99DD1`, giving back the original message `#x0ABCDEF0`. To anyone not knowing the secret key, the encoded message `#x8DD99DD1` is meaningless. This is potentially the basis of an excellent encryption technique but it suffers the major problem of how we setup the secret keys between everyone who wishes to encrypt their messages. You cannot send a key unencrypted since an eavesdropper will be able to see it, and you cannot send it encrypted because we have assumed you have no secret key already set up. You could possibly hand it over in person, by telephone or by post, but these methods take time a may be inconvenient. A better solution must be found.

It was not until 1978 that a suitable mechanism, called RSA public-key encryption, was invented (named after the developers Rivest, Shamir and Adleman). The idea is simple. The receiver publishes a key that everyone can read. The sender uses this key to encode the message and sends it to the receiver. The way the message is encoded is such that it cannot be decoded using the public key but requires an additional secret known only by the receiver, the person that published the public key. The public key consists of two carefully chosen random numbers r and e . To encode a message M , assumed to be less than r , we compute M^e (ie 1 multiplied by M , e times) and then take the remainder after division by r . If we call this encrypted value C , then

$$C = M^e \bmod r$$

Although this calculation looks horrendous, it is, in fact, quite easy to do, as shown in page 65. Knowing the public key is not enough to decode the encrypted message. However, there is a decoding exponent d that was calculated and kept secretly by the receiver when the public key of r and e was chosen. This can be used to decode the encrypted message M by evaluating the following:

$$C^d \bmod r$$

As an example, if the receiver chose a public key of $r=1576280161$ and $e=10000691$, and a decoding exponent of $d=899015831$, the calculations would be as follows.

$$\text{\#x0ABCDEF0}^{10000691} \bmod 1576280161 \text{ gives } \text{\#x5AF3EBFE}$$

and

$$\text{\#x5AF3EBFE}^{899015831} \bmod 1576280161 \text{ gives } \text{\#x0ABCDEF0}$$

This gives the correct result, and since only the receiver knows the decoding exponent, no one else can (easily) decode the message.

To see how the above calculations were done, look at the file `bcplprogs/crypt/rsa.b`. The next section (which may be skipped) gives a brief introduction to the underlying mathematics of RSA encryption.

4.7.1 RSA Mathematical Details

This section is entirely optional and should only be read by those who are interested. It shows how the public key and decoding exponent can be chosen, but does not go into the details of why the mechanism works. In practice, the public key should be rather large, perhaps 2000 bits or more in length. So all arithmetic must be done using numbers of this size rather than the 32 bits used in the previous section.

To create a new public key, first think up two large prime numbers p and q of roughly the same size and whose product is about 2000 bits long. Finding such large primes is out of the scope of this document. Now multiply p by q to give the first component of the public key. Next choose a number e that is about the same size as p , and check that it has no factors in common with $(p-1)*(q-1)$. This is extremely likely to be true if e is a prime. If the test succeeds e is the second component of the public key, otherwise keep trying other values for e . The decoding exponent d has the property

$$(e * d) = 1 \text{ modulo } (p-1)*(q-1)$$

This amounts to calculating $d = 1/e$ using arithmetic modulo $(p-1)*(q-1)$ which can be done efficiently using a program related to Euclid's greatest common divisor (GCD) algorithm.

The public key used in the previous section was based on the prime numbers $p=45007$ and $q=35023$. Their product was 1576280161 and the chosen encoding exponent was 10000691. The expression $(p-1)*(q-1)$ evaluates to 1226540484, and $(1/e)$ modulo 1226540484 gives 899015831, the decoding exponent.

Notice that if you can factorise the first component of the public key into its two prime factors p and q , you would be able to calculate the decoding exponent d and so would be able to decode any message using this public key. Luckily factorising such large numbers is thought by most mathematicians to be unfeasible.

This is only the germ of the idea of public key encryption. For a professional version much attention must be paid to subtle details of the implementation and use.

4.8 Vectors

We have already seen that variables are like named pigeon holes that contain numbers, and that they can be declared by declarations such as

```
LET x, y, z = 5, 36, 1004
```

To implement this declaration, BCPL finds three pigeon holes that are currently free, labels them with the names `x`, `y` and `z`, and puts the numbers 5, 36, 1004 into them. The BCPL Cintcode system normally has about 4 million pigeon holes to choose from, and each is labelled with an identifying number, similar to the way houses have numbers. Such numbers help postmen deliver letters, and pigeon hole numbers turn out to be fantastically useful in BCPL programs. The pigeon hole numbers of variables `x`, `y` and `z` can be found using the `@` operator, as in the following program.

```
GET "libhdr"
```

```
LET start() = VALOF
```

```
{ LET x, y, z = 5, 36, 1004
```

```
  writef("@x=%n @y=%n @z=%n*n", @x, @y, @z)
```

```
  RESULTIS 0
```

```
}
```

The following shows this program being compiled and run.

```
0.000> c b vec1
```

```
bcpl vec1.b to vec1 hdrs BCPLHDRS
```

```
BCPL (1 Feb 2011)
```

```
Code size =    80 bytes
```

```
0.030>
```

```
0.000> vec1
```

```
@x=12156 @y=12157 @z=12158
```

```
0.000>
```

Notice that the pigeon hole numbers for variables `x`, `y` and `z` are consecutive. This is no accident since BCPL always allocates consecutive pigeon holes to variables declared by simultaneous declarations. Pigeon hole numbers are normally called addresses and the symbol `@` was chosen because it looks like an *a* inside an *o* standing for *address of*.

Instead of using the name `x` to access the contents of its pigeon hole we can use the indirection operator (`!`) applied to the pigeon hole number. So if `@x` evaluates to 12156, then `!12156` would behave exactly like `x`.

We cannot tell in advance what the address of `x` will be, so it would be better to declare another variable `p`, say, to hold this value. The expressions `!p`, `!(p+1)` and `!(p+2)` are now equivalent to `x`, `y` and `z`. Since expressions like `!(p+1)` and `!(p+2)` are so useful, a dyadic version of the `!` operator is provided allowing these expressions to be written as `p!1` and `p!2`, as is shown in the following example.

```
GET "libhdr"

LET start() = VALOF
{ LET x, y, z = 5, 36, 1004
  LET p = @x
  p!2 := p!0 + p!1 // Equivalent to z := x + y
  writef("x=%n y=%n z=%n*n", x, y, z)
  RESULTIS 0
}
```

The output from this program is as follows.

```
x=5 y=36 z=41
```

Collections of consecutive pigeon holes are called vectors in BCPL. In other languages, they are often called one dimensional arrays. They are sometimes used to represent values that are too large to fit into a single BCPL word. An example is BCPL's representation of the current time and date as shown in the following program (`vec3.b`).

```
GET "libhdr"

LET start() = VALOF
{ LET days, msecs, filler = 0, 0, 0
  datstamp(@days)
  writef("days=%n msecs=%n filler=%n*n", days, msecs, filler)

  // Output the time in hh:mm:ss.mmm format
  writef("The time is %2i:%2z:%2z.%3z*n",
    msecs/(60*60*1000), // The hours
    msecs/(60*1000) MOD 60, // The minutes
    msecs/1000 MOD 60, // The seconds
    msecs MOD 1000) // The milli-seconds
  RESULTIS 0
}
```

We can run this program `vec3` immediately followed by the command `dat msec` separating by a semicolon (`;`) giving the following output.

```
0.010> vec3; dat msec
days=15502 msec=38273016 filler=-1
The time is 10:37:53.016
Monday 11-Jun-2012 10:37:53.020
0.000>
```

The argument given to the library function `datstamp` is the address of the first of three consecutive variables named `days`, `msec` and `filler` to hold a representation to the current time and date. After the call, `days` holds 15502 being the number of days since 1 January 1970, and `msec` holds 38273016 being the number of milli-seconds since midnight. To demonstrate this number is correct, it has been converted to hours, minutes and seconds and compared with the output of the `dat` command. By the way, `dat` stands for date and time.

Historically, `datstamp` was defined when BCPL was typically used on 16-bit computers such as the PDP-11, Data General Nova or the Computer Automation LSI-4. When BCPL words were only 16 bits long three words were need to represent the date and time. For compatibility with the past three words have been retained with the convention that `-1` in `filler` indicates that the new representation is being used.

It is all very well declaring vectors using simultaneous declarations, but this method is not feasible if we wish to declare a vector containing 1000 elements, or if we do not know how many elements we need until the program is running. The declaration `LET v = VEC 10` declares a variable `v` initialised with the address of 11 consecutive pigeon holes. They can be accessed by expressions such as `v!0`, `v!1` up to `v!10`. The operand of `VEC`, in this case 10, is the upperbound of the vector and must be a compile time constant. The elements of `v` are unnamed and so can only be accessed using the subscription operator (`!`). Vectors declared using `= VEC` are allocated from an area of memory called the run time stack which is of limited size (typically 50000 words), so if you require vectors larger than about 1000 elements, or if you do not know how large they should be until the program is running, you should allocate them using `getvec`. This function has one argument which is the upperbound of the vector required and it returns the address of its zeroth element, or zero if insufficient space is available.

Vectors allocated by `getvec` should be freed by calls of `freevec` otherwise space will be permanently lost. This is often called a space leak as illustrated by the following program (`vec4.b`).

```
GET "libhdr"
```



```

3601152 .....
3801216 .....
0.000>

```

This shows that the 3 million words allocated for `v2` have not been freed, so the next time `vec4` is executed it is unable to allocate `v2`.

```

0.000> vec4
getvec(100_000) => 62171
getvec(3_000_000) => 0
0.010>

```

An advantage of declaring a vector using `= VEC` is that it is automatically freed when execution leaves the block in which it was declared.

On page 38 we saw how to write out some Fibonacci numbers. We will now look at a program fills a vector with them.

```

GET "libhdr"

LET start() = VALOF
{ LET f = VEC 50 // A vector to hold Fibonacci numbers from 0 to 50
  f!0 := 0      // Fill in the first two Fibonacci number
  f!1 := 1
  // Now fill in the others
  FOR i = 2 TO 50 DO f!i := f!(i-1) + f!(i-2)

  // Now write out the result
  FOR i = 0 TO 50 DO
    writef("Position %2i Value %12u %32b*n", i, f!i, f!i)

  RESULTIS 0
}

```

It produces exactly the same output that we saw on page 48.

4.9 Primes

As another example of the use of vectors, we will look a program that finds all prime numbers less than a million. The program is as follows.

```

GET "libhdr"

LET start() = VALOF
{ LET upb = 1_000_000
  LET isprime = getvec(upb)

  FOR i = 2 TO upb DO isprime!i := TRUE // Until proved otherwise.

  FOR p = 2 TO upb IF isprime!p DO
  { LET i = p*p // Smaller multiples of p are already crossed out.
    // Cross out all multiples of p
    IF i>upb BREAK
    { isprime!i := FALSE; i := i + p } REPEATUNTIL i>upb
  }

  // Output some primes near the end
  FOR p = upb-100 TO upb IF isprime!p DO writef("%6i*n", p)

  freevec(isprime)
  RESULTIS 0
}

```

This program outputs the primes between 999900 and a million.

```

0.000> vec6
999907
999917
999931
999953
999959
999961
999979
999983
0.200>

```

Notice that this calculation was done in about 200 milli-seconds or about 1/5 of a second.

4.10 MANIFEST, GLOBAL and STATIC declarations

We have already seen how to declare local variables and vectors using LET, but there other ways to declare variables. The first of these is the MANIFEST declaration as in:

```

MANIFEST {
    col_red    = #xFF0000
    col_green  = #x00FF00
    col_blue   = #x0000FF

    n_op=0     // The operator field of a node
    n_r1       // The first operand field of a node
    n_r2       // The second operand field of a node

    // List of node operators
    s_num=1    // A number node
    s_mul      // A multiply node
    s_div      // A divide node
    s_add      // An add node
    s_sub      // A subtract node
}

```

This declaration declares various named constants such as `col_red` and `n_op`. If the name being declared is followed by an equal sign (=) then its value is that of the constant following the equals sign, otherwise its value is one larger than that of the previous name declared. Thus `n_r1` and `b_r2` have values 1 and 2.

The `GLOBAL` vector is a area of memory that is allocated when a program starts and usually has an upperbound of 1000. It is possible to give names to particular elements of the global vector and this is done using a `GLOBAL` declaration. The following example is a modification of part of the standard library header file `g/libhdr.h`.

```

GLOBAL {
    globsize:      0
    start:         1
    stop:          2
    sys:           3 //SYSLIB   MR 18/7/01
    clihook:       4
    muldiv:        5 //SYSLIB   changed to G:5 MR 6/5/05
    changeco:      6 //SYSLIB   MR 6/5/04
    currco:        7
    colist:        8
    rootnode:      9 // For compatibility with native BCPL
    result2
    returncode
    cis
}

```

```

cos
}

```

It declares that `globsize` is a variable at position zero of the global vector. By convention it holds the upper bound of the global vector which is usually 1000. This can be confirmed by executing `writeln("globsize=%n*n", globsize)`. The next variable is called `start` and is by convention is the first function of a program to be called.

The variables `result2`, `returncode`, `cis` and `cos` are not followed by colons (`:`) and so are given successively the next available global positions, namely 10, 11, 12 and 13.

The main advantage of global variables is that they provide a means of communication between separately compiled parts of the system. For instance, there is a precompiled library module called `blib` that contains the definitions of functions like `writeln` that we have used in all the example programs so far. The entry point to `writeln` actually resides in global 94 and is initialised at the moment a program starts.

`STATIC` declarations have a similar syntax to `MANIFEST` declarations but declare initialised variables rather than constants. Unlike manifest constants they can be updated using assignment statements. An example is as follows:

```

STATIC {
  a=1
  b
  c
}

```

This will declare three static variables `a`, `b` and `c` initialised to 1, 2 and 3. In general static variables should not be used unless absolutely necessary. They are usually better placed in the global vector.

4.11 Functions

We have already used functions several times. For instance, we have defined the function `start` in every program and we have used functions such as `writeln`, `datstamp`, `getvec` and `freevec` several times. In this section we examine functions in more detail.

Sometimes we have a fragment of code that we would like to use in several different places. It would therefore be good to have a simple way on executing that code without having to write the entire fragment on each time. In most programming languages this can be done by wrapping up the code in something called a function. As an example we will look at the definition of the library

function `randno` which generates a sequence of pseudo random numbers. Its definition is as follows.

```
LET randno(upb) = VALOF
{ // Return a random number in the range 1 to upb
  randseed := randseed*2147001325 + 715136305
  RESULTIS (ABS(randseed/3)) MOD upb + 1
}
```

This declares the function `randno` whose entry point is held in global variable 34 as declared in `libhdr.h`. Within its body it refers to `randseed` which is declared as global 35. The function is an implementation of what is called a congruential random number generator with carefully chosen constants 2147001325 and 715136305 to cause it to cycle though a huge number of apparently random values. The use of `ABS`, division by 3, `MOD` and `+1` remove some of the deficiencies of the `randseed` sequence and restrict the resulting numbers to the required range of 1 to `upb`. Each value in this range should occur with equal likelihood.

There are two things to note about function definitions. Firstly, if the name of the function is already declared as a global then its entry point becomes the initial value of that global. Secondly, every variable used inside a function must either be declared inside that function or be declared by a function, `MANIFEST`, `GLOBAL` or `STATIC` declaration. Thus so called dynamic free variables are not allowed. An easy way to avoid this problem is never to define one function inside another. (This is enforced syntactically in the language C).

You can pass a collection of values to a function when you call it. These are called *arguments* and are enclosed in round brackets (`'('` and `')'`). We have already seen this done in calls like `writeln("x=%n y=%n z=%n*n", x, y, z)`. Here we are calling the function `writeln` giving it four arguments. The first is a string (actually represented by a pointer to the length and characters of the string), and the remaining ones are the values of `x`, `y` and `z`. When a function is declared it is given a list of names enclosed in round brackets and separated by commas. These names behave just like local variables that have been initialised from left to right with the argument values. The declaration of `writeln` is in the file `sysb/blib.b` and its first two lines are:

```
LET writeln(format,a,b,c,d,e,f,g,h,i,j,k,l,m,
            n,o,p,q,r,s,t,u,v,w,x,y,z) BE
```

As can be seen, its first argument is called `format` to hold the format string given in the call. The remaining 26 arguments are initialised to as many arguments as were supplied in the call. Hopefully no one will call `writeln` with more than this number of arguments. If they do the later arguments will be lost. Just

as simultaneously declared local variables live in adjacent pigeon holes, the same applies to function arguments. So, for instance, the arguments **a** to **z** can thought of as a vector of 26 elements pointed to by **@a**, and so can be accessed conveniently as needed within the declaration of **writeln**. Functions taking variable numbers of arguments are often called variadic functions. They are clearly useful but often difficult to implement sensibly in other languages.

The word **BE** in the declaration of **writeln** indicates that its result is undefined and that its body is not an expression but a command or command sequence. After all, **writeln** is not designed to compute a value since its purpose is to output some formatted text.

Functions designed to compute results are declared using **=** in place of **BE**, and after the equal sign there is an expression (not a command). A simple example is the definition of the factorial function that computes $1 \times 2 \times 3 \dots \times n$ for a given argument n . Its definition is as follows:

```
LET fact(n) = n=0 -> 1, n*fact(n-1)
```

The expression **n=0 -> 1, n*fact(n-1)** is an IF-THEN-ELSE construct for expressions. It computes the condition, in this case **n=0**, and if the result is non zero (representing TRUE) it returns the first alternative namely **1**, otherwise it returns the result of evaluating **n*fact(n-1)**. The interesting thing about this definition is that it is recursive, defining **fact** in terms of itself, based on the idea that factorial 0 is 1 and for non zero n factorial of n is $n \times$ factorial of $n - 1$.

Another example is a rather beautiful definition of a function to compute Fibonacci numbers. The following program outputs them up to position 50.

```
GET "libhdr"

LET fib(n) = n=0 -> 0,
            n=1 -> 1,
            fib(n-1) + fib(n-2)

LET start() = VALOF
{ FOR i = 0 TO 50 DO
  writeln("Position %2i Value %12u*n", i, fib(i))

  RESULTIS 0
}
```

When you run this program it takes longer and longer to output each line, and if you time it with a stopwatch, each line take a time approximately proportional to the value of the Fibonacci number it is printing. On my laptop it takes about

2 hours to output all 51 Fibonacci numbers and, although I have not tried, I would expect it to take about 8 times longer on the Raspberry Pi. It is perhaps interesting to explore why this wonderfully elegant little program is so inefficient.

Let us try and define a cost function $C(n)$ that is the cost (in time) of computing $\text{fib}(n)$. When n is 0 or 1 computing $\text{fib}(n)$ is very cheap. Let us arbitrarily say the cost of computing $\text{fib}(0)$ is so small it can be zero and the cost of computing $\text{fib}(1)$ is one unit. For larger values of n the cost is dominated by the cost of computing $\text{fib}(n-1)$ and $\text{fib}(n-2)$ giving a total of $C(n-1) + C(n-2)$. So we have defined the cost function C to have the following properties.

$$\begin{aligned} C(0) &= 0 \\ C(1) &= 1 \\ C(n) &= C(n-1) + C(n-2) \quad \text{when } n > 1 \end{aligned}$$

This recurrence relation gives us exactly the same sequence of values as the Fibonacci sequence itself which explains why the time to output each line is approximately proportional to the Fibonacci number being written. In the next section (which is entirely optional) we will obtain a simple formula for C (and indeed $\text{fib}(n)$).

4.12 Solving the recurrence relation for C

In this section we explore the peculiar way in which mathematicians think. They are typically extremely optimistic, thinking they can solve apparently unsolvable problems. They are persistent, repeatedly trying different approaches when all earlier attempts have failed, and they have usually acquired reasonable skill in algebraic manipulation.

To solve this problem, a mathematician checks whether $C(n)$ grows as fast as n^2 or n^3 but soon discovers that it grows much faster. Indeed it looks as if it grows faster than n^k for any k . Oh dear, we must find a formula that grows faster than any of these. How about X^n ? So lets try $C(n) = X^n$. This clearly is not right, but lets try it all the same. When n is large, substituting this in our definition of $C(n)$ gives us $X^n = X^{n-1} + X^{n-2}$. Assuming X is not zero we can divide both sides of the equation by X giving $X^{n-1} = X^{n-2} + X^{n-3}$ and if we repeatedly divide by X we eventually get the beautifully simple equation $X^2 = X + 1$. If we rearrange this to be $X^2 - X = 1$ and then add $1/4$ to both sides we get $X^2 - X + 1/4 = 1 + 1/4 = 5/4$. We can now take the square root of both sides giving $X - 1/2 = \sqrt{5}/2$. So possible values of X are $(1 + \sqrt{5})/2$ and $(1 - \sqrt{5})/2$. The first of the has a value of about 1.618 and is so famous it is called the Golden Ratio. Look it up on the Web to see why it is so important. The second value is approximately -0.618. If we call these two values α and β , we can convince ourselves that a mixture of the two such as $A\alpha^n + B\beta^n$ also satisfies

the relation, and by choosing suitable values for A and B , we can make a simple formula match $C(n)$ exactly. Substituting n equals 0 and 1 in our definition of $C(n)$ we get $C(0) = A\alpha^0 + B\beta^0 = A + B = 0$ and $C(1) = A\alpha + B\beta = 1$. The first equation tells us that $B = -A$, and substituting this in the second equation gives $A(\alpha - \beta) = 1$. Remembering that $\alpha = (1 + \sqrt{5})/2$ and $\beta = (1 - \sqrt{5})/2$ we can easily deduce that $A = 1/\sqrt{5}$. The formula for $C(n)$ is thus

$$C(n) = (\alpha^n - \beta^n)/\sqrt{5}.$$

or

$$C(n) = \frac{(1+\sqrt{5})^n - (1-\sqrt{5})^n}{2^n\sqrt{5}}.$$

As a challenge, convince yourself that this yields a whole number for every n even though this formula contains $\sqrt{5}$ three times.

4.13 Greatest Common Divisor

The greatest common divisor (the GCD) of two positive numbers is the largest number that exactly divides into both of them. For instance the GCD of 18 and 30 is 6. In roughly 200 BC, Euclid devised an efficient way of computing it. It is essentially as follows. If they are equal that is the answer, otherwise replace the larger number by the remainder of dividing it by the smaller number, repeating the process until both numbers are equal. A BCPL implementation of this is as follows:

```
GET "libhdr"

LET gcd(a, b) = VALOF
{ LET r = a MOD b // r will be less than b
  IF r=0 RESULTIS b // b exactly divides a so is the gcd
  // r and b have the same gcd as a and b
  a := b
  b := r // a is greater than b
} REPEAT

LET try(a, b) BE
{ LET res = gcd(a, b)
  writef("gcd(%n, %n) = %n*n", a, b, res)
}
```

```
LET start() = VALOF
{ try(18, 30)
  try(1000, 450)
  try(1576280161, 1226540484)
}
```

This gives the following output.

```
gcd(18, 30) = 6
gcd(1000, 450) = 50
gcd(1576280161, 1226540484) = 1
```

Notice that if b is greater than a initially, then the first iteration of the REPEAT loop just swaps these variables.

4.14 Powers

Another example worth looking at is how to raise a number to a large power using modulo arithmetic. That is how can we calculate x^n modulo m efficiently as is required by the RSA mechanism described above.

Two ideas come to mind. One is that when we want to calculate, say, 1234×5678 modulo 100, we need only consider the two least significant digits of each number, since the others cannot affect the answer. So calculating 34×78 modulo 100 gives the same result. This generalises to $a \times b$ modulo m gives the same result as $((a \text{ modulo } m) \times (b \text{ modulo } m)) \text{ modulo } m$. The other idea is to consider the binary representation of the exponent. For instance, if we want to calculate 7^{25} , we observe that 25 is 11001 in binary corresponding to $16 + 8 + 1$ so multiplying 1 by 7, 25 times is the same as multiplying 1 by 7, 16 times, then multiplying by 7, 8 times and finally multiplying by 7 once more. In mathematical notation this is just saying

$$7^{25} = 7^{16+8+1} = 1 \times 7^{16} \times 7^8 \times 7.$$

We can easily calculate 7^2 , 7^4 , 7^8 and 7^{16} since $7^2 = 7 \times 7$, $7^4 = 7^2 \times 7^2$, $7^8 = 7^4 \times 7^4$, etc. Based on these ideas we can construct an elegant program that compute x^n modulo m , such as the following.

```
LET powmod(x, n, m) = VALOF
{ LET res = 1
  LET p = x MOD m
  WHILE n DO
  { IF (n & 1)=0 DO res := (res * p) MOD m
    n := n>>1
```

```

    p := (p*p) MOD m
  }
  RESULTIS res
}
```

This program has two disadvantages. One is that it is using signed arithmetic and secondly it has a problem with overflow and so only works with quite small numbers. A version using full 32-bit unsigned numbers is as follows.

```

GET "libhdr"

LET add(x, y, m) = VALOF
{ LET a = x+y

  IF x<0 & y<0 & a>0 RESULTIS a-m

  IF a-m<0 RESULTIS a // Unsigned comparison
  RESULTIS a-m
}

AND mul(x, y, m) = y=0 -> 0,
                  (y&1)=0 -> mul(add(x,x,m), y>>1, m),
                  add(x,      mul(add(x,x,m), y>>1, m), m)

AND pow(x, y, m) = y=0 -> 1,
                  (y&1)=0 -> pow(mul(x,x,m), y>>1, m),
                  mul(x,      pow(mul(x,x,m), y>>1, m), m)

LET start() = VALOF
{ LET a, n, m = 7, 25, 19
  writef("%n****%n modulo %n = %n*n", a, n, m, pow(a, n, m))

  a, n, m := #x0ABCDEF0, 10000691, 1576280161 // Should give #x5AF3EBFE
  writef("%8x****%n modulo %n = %8x*n", a, n, m, pow(a, n, m))
  RESULTIS 0
}
```

4.15 Compilation

So far we have looked at a few BCPL programs and invoked the BCPL compiler before running them. In this section we explore what the BCPL compiler actually does and how the compiled code is executed. To illustrate what is going on we will consider the following simple program (in `bcplprogs/raspi/demo.b`).

```

GET "libhdr"

LET start() = VALOF
{ LET n = 7
  LET count = 0

  { count := count+1
    IF n=1 RESULTIS count
    TEST n MOD 2 = 0
    THEN n := n/2
    ELSE n := 3*n+1
  } REPEAT
}

```

This program declares two variables `n` and `count` initialised to 7 and zero. It then enters a `REPEAT` loop in which it increments `count` before testing to see if `n` is one. If it is, it returns from `start` with the current value of `count`. By convention, a non zero result is treated as an error causing its value to be output, as in:

```

0.010> c b demo
bcpl demo.b to demo hdrs BCPLHDRS

BCPL (24 July 2012)
Code size =    68 bytes
0.020> demo
demo failed returncode 17 reason -1
0.010>

```

This indicates that when it detects that `n` equals to 1, `count` equals to 17. The `TEST` statement causes `n` to be set to `n/2` if `n` was even or `3*n+1` if `n` was odd. These operations are repeated until the program is terminated by the `RESULTIS` statement. With `n` initially set to 7, the sequence of values of `n` has length 17 and is as follows:

7, 22, 11, 34, 17, 52, 26, 13, 40, 20, 10, 5, 16, 8, 4, 2, 1

Before running `demo` we have to compile it using a command such as `c b demo`. The effect of this is to read the file `demo.b` and output a file called `demo`. This file can be displayed using the `type` command as follows:

```
0.010> type demo
```

```
000003E8 00000011
00000011 0000DFDF 6174730B 20207472 20202020
A410A317 11A4C411 84033C83 3612837B 12B5073E
EDBAA335 D1341383 00E6BAA3 00000000 00000001
00000014 00000001
0.000>
```

At first sight this compiled code does not look very comprehensible. It basically consists of a sequence of 32-bit words given in hexadecimal. The first (000003E8) indicates that this is a hunk of compile code whose length is given by the next value (00000011). The rest of the file gives the actual data that must be loaded into memory before the `demo` program can be run. This code is much easier to understand if we use the `d1` option when invoking the compiler. The output this generates is as follows:

```
0.000> c b demo d1
bcpl demo.b to demo hdrs BCPLHDRS d1
```

```
BCPL (24 July 2012)
  0: DATAW 0x00000000
  4: DATAW 0x0000DFDF
  8: DATAW 0x6174730B
 12: DATAW 0x20207472
 16: DATAW 0x20202020
// Entry to:  start
 20: L1:
 20:  L7
 21:  SP3
 22:  L0
 23:  SP4
 24: L3:
 24:  L1
 25:  AP4
 26:  SP4
 27:  L1
 28:  LP3
 29:  JNE  L4
 31:  LP4
 32:  RTN
 33: L4:
 33:  LP3
 34:  L2
 35:  REM
```

```

36:  JNE0  L5
38:  XCH
39:  L2
40:  DIV
41:  SP3
42:  J  L3
44: L5:
44:  LP3
45:  L3
46:  MUL
47:  A1
48:  SP3
49:  J  L3
51: L2:
52:  DATAW 0x00000000
56:  DATAW 0x00000001
60:  DATAW 0x00000014
64:  DATAW 0x00000001
Code size = 68 bytes
0.030>

```

The word at position zero will hold the length of the compiled code when it is known, and this is followed by four words that indicate that the function named **start** follows at byte position 20 in this module. The compiler kindly comments this position to make the code more readable.

The compiled code consists of a sequence of 8-bit bytes in a language called Cintcode (Compact Interpretive Code) that was specifically designed for BCPL. Most Cintcode instructions occupy just one byte and correspond to simple operations performed on the Cintcode Abstract Machine. This machine has some central registers, the most important being **PC**, the program counter, that points to the next Cintcode instruction to execute, and **A** and **B** that are used during the evaluation of expressions. To see how Cintcode works we will execute this program one Cintcode instruction at a time. We can do this by typing the following piece of magic.

```

0.000> abort

!! ABORT 99: User requested
* x
Breakpoint 9 at start of clihook

0.010> demo

!! BPT 9:          clihook

```

```

    A=          0 B=          0 20092:    K4G  1
* \ A=         0 B=          0 48532:    L7
*

```

The `abort` command enters an interactive debugger and the debugging command `x` sets a break point just before `start` is entered. When we try to execute the `demo` command, we immediately hits this break point just as it is about to execute the Cintcode instruction `K4G 1` to enter the function `start`. The debugger issues the prompt `*` inviting us to type a debugging command. We then press the `\` key to cause one Cintcode instruction to be executed leaving the system about to execute `L7` at byte address 48532. We can see that both registers `A` and `B` contain zero.

The compiled code for `LET n = 7` is `L7` to load 7 into `A` followed by `SP3` to store `A` in the memory location whose address is `P+3` where `P` is another central register of the Cintcode Machine. At this moment `P` points to an area of memory used to hold local variables belonging to the function `start`, and the compiler has chosen to allocate the location at offset 3 to hold the variable `n`. Pressing `\` twice performs these two instructions, as follows:

```

* \ A=         0 B=          0 48532:    L7
* \ A=         7 B=          0 48533:    SP3
* \ A=         7 B=          0 48534:    L0
*

```

Initialising `count` can be performed by pressing `\` twice more as follows:

```

* \ A=         7 B=          0 48534:    L0
* \ A=         0 B=          7 48535:    SP4
* \ A=         0 B=          7 48536:    L1
*

```

Notice that when a value is loaded into `A`, the previous content is copied into `B`. We have now entered the `REPEAT` loop and are about to execute the compiled code for `count:=count+1` as can be seen by pressing `\` three more times.

```

* \ A=         0 B=          7 48536:    L1
* \ A=         1 B=          0 48537:    AP4
* \ A=         1 B=          0 48538:    SP4
* \ A=         1 B=          0 48539:    L1
*
*

```

L1 loads 1, AP4 adds the value in P4 (=count) and SP4 stores the result back in P4. The next three instructions test whether *n* equals 1.

```
* \ A=          1 B=          0  48539:    L1
* \ A=          1 B=          1  48540:    LP3
* \ A=          7 B=          1  48541:    JNE  48545
*
```

L1 and LP3 load *n* and 1 in A and B, and the JNE 48545 instruction sets PC to 48545, if *n* is not equal to 1. Although the destination of the jump (48545) is too large to fit into an 8-bit byte, it is actually encoded as an 8-bit signed relative address in Cintcode. So jump instructions only occupy 2 bytes. Cintcode has a cunning mechanism to deal with jumps over large distances. The next four instructions test whether *n* is even.

```
* \ A=          7 B=          1  48545:    LP3
* \ A=          7 B=          7  48546:    L2
* \ A=          2 B=          7  48547:    REM
* \ A=          1 B=          7  48548:    JNE0 48556
*
```

The REM instruction sets A to the remainder after dividing *n* by 2, and the JNE0 48556 instruction sets PC to 48556 if this remainder is not zero, ie if *n* is odd. So rather than halving *n* we now compute $n:=3*n+1$ as follows:

```
* \ A=          1 B=          7  48556:    LP3
* \ A=          7 B=          1  48557:    L3
* \ A=          3 B=          7  48558:    MUL
* \ A=          21 B=         7  48559:    A1
* \ A=          22 B=          7  48560:    SP3
* \ A=          22 B=          7  48561:    J  48536
*
```

LP3 L3 MUL multiplies *n* by 3 giving 21, A1 increments the result giving 22, and SP3 updates *n* with this new value. The next instruction J 48536 jumps us back to the start of the REPEAT loop.

We can remove the break point using the debugging command 0b9 and continue normal execution by typing c.

```
* \ A=          22 B=          7  48561:    J  48536
* 0b9
* c
demo failed returncode 17 reason -1
0.010>
```

While in the debugger, pressing ? gives a useful summary of the possible debugging commands. For more information about Cintcode and the debugger see the BCPL manual ([bcplman.pdf](#)) available via my home page.

4.16 The Collatz Conjecture

The previous section contained a program that computed a sequence of numbers from a given starting value using a simple rule to determine whether to replace n by $n/2$ or $3*n+1$. Collatz conjectured in 1937 that the sequence always reaches 1 for every starting value. Surprisingly, no one has yet been able to prove this. You can learn all about the Collatz Conjecture by searching the web using the keyword `Collatz`.

If the conjecture is false, either there will be a starting value that generates a sequence either ending in a loop not containing one, or generating larger and larger numbers indefinitely. The following simple program (`collatz0.b`) generates Collatz sequences from a given starting value.

```
GET "libhdr"

LET start() = VALOF
{ LET n = 7
  LET count = 0

  { count := count+1
    writef("%5i: %10i*n", count, n)
    IF n=1 BREAK
    TEST n MOD 2 = 0
    THEN n := n/2
    ELSE n := 3*n+1
  } REPEAT

  RESULTIS 0
}
```

In this program the starting value is held in `n`. It outputs `n` and its position in the sequence before updating `n` with the next value. The test `n MOD 2 = 0` determines whether `n` is even, replacing `n` by `n/2` if it was, otherwise setting `n` to `3*n+1`. The program breaks out of the `REPEAT` loop if `n` reaches one, otherwise it goes on for ever outputting more and more numbers in the sequence. You can easily test a different starting value by modifying the declaration of `n`. For instance, if the declaration was replaced by `LET n = 123456789` you will find the sequence terminates at position 178.

An imperfection of this program is that it may suffer from overflow. The following program (`collatz1.b`) corrects this fault stopping with a message when

it discovers that the next value will be too large to hold in a BCPL variable. This can only happen when n is odd and $3*n+1$ is greater than the largest number `maxint` that can be represented. So if $n > (\text{maxint}-1)/3$ the next number in the sequence will be too large.

```

GET "libhdr"

LET start() = VALOF
{ LET n = 123456789
  LET count = 0
  LET lim = (maxint-1)/3

  { count := count+1
    writef("%5i: %10i*n", count, n)
    IF n=1 BREAK
    TEST n MOD 2 = 0
    THEN { n := n/2
          }
    ELSE { IF n > lim DO
           { writef("Number too big*n")
             BREAK
           }
           n := 3*n+1
         }
    } REPEAT

  RESULTIS 0
}

```

A variant of this program is given in Section 5.4 on page 310 that plots the relationship between sequence lengths and starting values.

Even with the program given above you will not be able to find a starting value that disproves the Collatz Conjecture since it has already been tested for all starting values up to 5×2^{60} . So if we are going to disprove the conjecture we must modify the program to use numbers of higher precision. The following program (`collatz2.b`) uses numbers with up to about one million binary digits. It starts as follows:

```

GET "libhdr"

MANIFEST {
  upb = (1<<20)-1 // ie about 1 million digits max
  mask = upb
  countt=10000 // count at start of test loop
  looplen=541 // Length of test loop
}

```

```

}

GLOBAL {
  digv:ug // digv is a circular buffer holding a number with up
          // to upb binary digits, with one digit per element.
  digp    // Position of the least significant binary digit of
          // the number.
  digq    // Position of the most significant digit of the number.
  count   // Position of the number in digv in the sequence
  digvc   // Copy of the number at last checkpoint
  digcs   // Count of digits in digvc.
  countchk // Count at last checkpoint

  digvt   // Digits of the number at the start of the test loop
  digts   // Count of digits in digvt

  eq1     // Returns TRUE if the number in digv is 1,
          // ie digp=digq and digv!digp=1
  divby2  // Function to divide the number in digv by 2
  mulby3plus1 // Function to replace the number in digv by 3*n+1
  tracing // =TRUE causes the numbers to be output
  looptest // If TRUE, a loop of values is created
           // to test that loops can be detected
}

```

The binary digits of the number are held in consecutive elements of the circular buffer `digv`, ordered from least to most significant digit. The least and most significant digits have subscripts `digp` and `digq`. If the number has only one digit `digp` will equal `digq`. `count` holds the position of the number in `digv` in the sequence. In order to detect a loop the number in `digv` is copied into `digvc` every time `count` is a power of two. Every time the next number is generated it is compared with the number in `digvc`. If there is a loop this test will eventually yield TRUE. To test that the loop detection mechanism works, the variable `looptest` is set to TRUE. This causes the number at position `countt` (currently equal to 10000) to be copied into `digvt`, and every time `count` advances by `looplen` (currently 541) the number in `digv` is replaced by the number in `digvt`. The loop detection mechanism should detect this loop. Normally the program just output the position of each number in the sequence and its bit length, but if `tracing` is TRUE it also outputs the binary digits of each number.

The main program is as follows:

```

LET start() = VALOF
{ LET len = 5
  LET seed = 12345

```

```

LET argv = VEC 50

UNLESS rdargs("len/n,seed/n,t/s,loop/s", argv, 50) DO
{ writef("Bad args for collatz2*n")
  RESULTIS 0
}

IF argv!0 DO len := !(argv!0)      // LEN/N
IF argv!1 DO seed := !(argv!1)    // SEED/N
tracing := argv!2                 // T/S
looptest := argv!3               // LOOP/S

setseed(seed)

UNLESS 0<len<upb DO
{ writef("len must be in range 1 to %n*n", upb)
  RESULTIS 0
}

digv := getvec(upb)
digvc := getvec(upb)
UNLESS digv & digvc DO
{ writef("upb too large -- more space needed*n")
  RESULTIS 0
}

digvt := 0

IF looptest DO
{ digvt := getvec(upb)
  UNLESS digvt DO
  { writef("upb too large -- more space needed*n")
    RESULTIS 0
  }
}

// Initialise digv with a random number of length len
digp := 0
FOR i = 0 TO len-2 DO digv!i := randno(2000)/1000
digv!(len-1) := 1      // Plant a most signigicant 1
digq := len-1        // Set position of the most significant digit
digcs := -1
count := 0

{ LET digs = ((digq+mask+1-digp) & mask) + 1

```

```

count := count+1
writef("%9i %6i: ", count, digs)
IF tracing DO prnum()
newline()

// Check whether the current number has been seen before
IF digs = digcs DO
{ // Numbers are the same length so check the digits
  writef("Checking the digits*n", digs)
  FOR i = 0 TO digs-1 UNLESS digvc!i=digv!((digp+i)&mask) GOTO notsame
  writef("nLoop of length %n found at count = %n*n",
        count-countchk, count)
  GOTO fin
}

notsame:
  IF (count&(count-1))=0 DO
  { // Set new check value in digvc
    FOR i = 0 TO digs-1 DO digvc!i := digv!((digp+i)&mask)
    digcs := digs
    countchk := count // Remember the position of the check value
    writef("%9i %6i: Set new check value*n", count, digs)
  }

  IF looptest DO
  { IF count=countt DO
    { // Create a loop starting here
      FOR i = 0 TO digs-1 DO digvt!i := digv!((digp+i)&mask)
      digts := digs
      writef("%9i: Save start of loop number*n", count)
    }

    IF count>countt & (count-countt) MOD looplen = 0 DO
    { // Return to start of test loop
      FOR i = 0 TO digts-1 DO digv!i := digvt!i
      digp, digq := 0, digts-1
      writef("%9i: Restore start of loop number*n", count)
    }
  }

  IF eq1() BREAK
  TEST digv!digp=0 // Test for even
  THEN divby2()
  ELSE mulby3plus1()

```

```

    } REPEAT

fin:
  IF digv DO freevec(digv)
  IF digvc DO freevec(digvc)
  IF digvt DO freevec(digvt)
  RESULTIS 0
}

```

The argument `len` specified the length in binary digits of the initial number in the sequence. This length must be between 1 and about one million. The digits of the starting value are chosen using a random number generator whose initial seed can be specified by the `seed` argument. If no seed is specified a seed of 12345 is initially chosen but then updated to a value depending on the current time of day. If no specific seed is chosen, it might happen that a random starting value of say 900000 digits was found that proved the conjecture false by ending with a loop not containing one, but not knowing the seed you would not be able to reproduce your fantastic discovery. Such a situation would be unimaginably annoying. If the argument `t` is given `tracing` will be set to `TRUE` and if `loop` is given `looptest` will be set to `TRUE` to test the loop detection mechanism.

The code is fairly self explanatory. It contains the loop detection mechanism and the code to generate a loop if `looptest` is `TRUE`. The call `eq1()` return `TRUE` if the current value in `digv` represents one. The current value in `digv` is even if its least significant digit is zero, that is if `digv!digp=0`. The call `divby2` divides the value in `digv` by 2, and `mulby3plus1()` multiplied the number in `digv` by three and adds one. These functions are defined below.

```
AND eq1() = digp=digq & digv!digp=1 -> TRUE, FALSE
```

```
AND divby2() BE
{ TEST digp=digq
  THEN digv!digp := 0
  ELSE digp := (digp+1)&mask
}

```

```
AND mulby3plus1() BE
{ // Calculate 3*n+1 eg
  //      1 +
  //    1011 +
  //   10110 =
  //  -----
  // 100010
  LET carry = 1
  LET prev  = 0

```

```

LET i = digp

{ LET dig = digv!i
  LET val = carry+dig+prev
  digv!i := val&1
  carry := val>>1
  prev := dig
  IF i=digq DO
  { IF prev=0=carry RETURN // No need to lengthen the number
    i := (i+1)&mask
    digv!i := 0
    digq := i
    LOOP
  }
  i := (i+1)&mask
} REPEAT
}

AND prnum() BE
{ LET i = digp
  { LET dig = digv!i
    wrch('0'+dig)
    IF i=digq RETURN
    i := (i+1)&mask
  } REPEAT
}

```

The final function `prnum()` just outputs the digits of the number in `digv`.

Using this program you can test random starting values with lengths up to about one million binary digits, and if there is a value that disproves the Collatz Conjecture you might be lucky enough to find it. But I think that unlikely since I am convinced the conjecture is true.

4.17 The Pig Dice Game

This is a two player game that uses a six sided die, first described by John Scarne in 1945. It is an example of a *jeopardy race game* in which players have to choose repeatedly between making a small gain with high probability or possibly making a large loss with small probability. Each player has bank balance and, when having the die, a turn score. During a player's turn, if a one is thrown, the player bank balance is left unchanged and the die is passed to the other player. But, if a value between 2 and 6 is thrown, it is added to the turn score. At any point the player may terminate the turn by saying "hold". This causes the turn score to be added to the player's balance before handing the die to the other

player. The first player to obtain a balance of 100 or more wins. Quite a good strategy is to hold after the turn score reaches 21.

The optimum choice of whether to throw the die or hold depends on the player's current scores, the other player's and the current turn score. Since these three values are all between zero and 99, there are one million possible states of the game. The optimum playing strategy just specifies for which states it is best to throw the die. The optimum strategy turns out to be extremely strange, counter intuitive and complicated. This strategy is given later in this section.

But first, I describe the program `pig.b` that just allows the user to play the game against the computer. It takes several numeric arguments: `a1`, `b1`, `c1`, `a2`, `b2` and `c2`. If the `a1` is zero, player 1 is a user controlled by input from the keyboard. When it is player 1's turn, pressing `P` causes the die to be thrown and pressing `H` terminates the turn. If either a one is thrown or `H` is pressed the die is passes to the other player. If `a1` is non zero, player 1 is played by the computer using a strategy specified by `a1`, `b1` and `c1`. If `a1` is negative, player 1 is played by the computer using the optimum strategy based on data in the file `pigstrat.txt`, but if `a1` is greater than zero the computer uses a playing strategy defined by `a1`, `b1` and `c1`. You can think of the game state as a point (my, op, ts) in a 3D cube where `my` and `op` are player 1 and player 2's bank balances and `ts` is player 1's current turn score. If we assume that the `ts` axis is vertical, the coordinates (my, op) identify a point on a horizontal square. We can think of this square as the floor of a shed. The strategy is based on a sloping plane that can be thought of as the shed's roof. If `ts` is less than the height of the roof at floor position (my, op) the strategy is to play the die, otherwise player 1 should hold. The orientation of the roof is defined by its height `a1` at the origin $(0,0)$, `b1` at position $(99,0)$ and `c1` at position $(0,99)$, and so, if $ts < a + (b-a) * my / 99 + (c-a) * op / 99$, the strategy is to throw the die. The default settings for `b1` and `c1` are both set to `a1`. This, of course, represents a horizontal roof of height `a1`.

Player 2's strategy is specified similarly using arguments `a2`, `b2` and `c2`. It is thus possible to cause the computer to play itself with possibly different strategies. A new game can be started by pressing `S`, and the program can be terminated by pressing `Q`. After each game, the tally of wins by each player is output. This is useful when comparing the effectiveness of different playing strategies. The program starts by declaring globals as follows.

```
GET "libhdr"

GLOBAL {
    stdin:ug
    stdout
    ch
    a1; b1; c1    // Player1's strategy parameters
```

```

a2; b2; c2      // Player2's strategy parameters
score1; score2 // The players' scores
player         // =0 if game ended,
               // =1 if it is player 1's turn,
               // =2 if it is player 2's turn.
wins1; wins2   // Count of how often each player has won
quitting       // =TRUE when Q is pressed
newgameP       // The longjump arguments to
newgameL       // start a new game
strategybytes; strategybytesupb; strategystream
}

```

Next is the definition of the main function `strategyrdch`.

```

LET strategyrdch() = VALOF
{ LET ch = rdch()
  UNLESS ch='(' RESULTIS ch
  // Ignore text enclosed within parentheses
  { ch := rdch()
    IF ch=endstreamch RESULTIS endstreamch
  } REPEATUNTIL ch=')'
} REPEAT

```

This function is used to read characters from the file `pigstrat.txt` when loading the optimum strategy. It behaves like `rdch` but skips over text enclosed in parentheses. The definition of `start` then follows.

```

LET start() = VALOF
{ LET days, msecs, filler = 0, 0, 0
  LET argv = VEC 50

  UNLESS rdargs("a1/n,b1/n,c1/n,a2/n,b2/n,c2/n",
               argv, 50) DO
  { writef("Bad argument(s) for pig*n")
    RESULTIS 0
  }

  a1, b1, c1 := 0, 0, 0 // Player1's strategy
  a2, b2, c2 := -1, 0, 0 // Player2's strategy
  wins1, wins2 := 0, 0
  quitting := FALSE

  IF argv!1 DO a1 := !(argv!0)
  b1, c1 :0 a1, a1
  IF argv!1 DO b1 := !(argv!1)

```

```

IF argv!2 DO c1 := !(argv!2)
IF argv!3 DO a2 := !(argv!3)
b2, c2 := a2, a2
IF argv!4 DO b2 := !(argv!4)
IF argv!5 DO c2 := !(argv!5)

newgameP, newgameL := level(), newgame
datstamp(@days)
setseed(msecs)

```

The program first reads the command arguments, if any, that specify whether the two players are interactive users, the computer or one of each. For the computer players, the values of the arguments specify which strategy the computer will use. By default, `a1=0` causing player 1 to be interactive user and `a2=-1` causing player 2 is the computer playing the optimum strategy. Unless `b1` and `c1` are explicitly given they are set equal to `a1`. The same convention applies to `b2` and `c2`.

The variables `newgameP` and `newgameL` are set so the call `longjump(newgameP,newgameL)` in function `userplay` will cause jump back into `start` where a new game can be started. Finally the random number seed is set to a value based on the current time of day. The program continues as follows.

```

strategybytes := 0
strategybytesupb := 100*100-1
strategystream := 0

IF a1<0 | a2<0 DO
{ // Load the optimum strategy data from file pigstrat.txt
  strategybytes := getvec(strategybytesupb/bytesperword)
  UNLESS strategybytes DO
  { writef("Unable to allocated strategybytes*n")
    GOTO fin
  }
}

strategystream := findinput("pigstrat.txt")
UNLESS strategystream DO
{ writef("Unable to open pigstrat.txt*n")
  GOTO fin
}

selectinput(strategystream)

{ LET i, ch = 0, 0

```

```

{ LET x = 0

  ch := strategyrdch() REPEATUNTIL '0'<=ch<='9' | ch=endstreamch
  IF ch=endstreamch BREAK

  WHILE '0'<=ch<='9' DO
  { x :=10*x + ch - '0'
    ch := strategyrdch()
  }
  IF i <= strategybytesupb DO strategybytes%i := x
  i := i+1
} REPEAT
UNLESS i = 100*100 DO
{ writef("pigstrat.txt contains %n numbers, should be 10000*n", i)
  GOTO fin
}
}
endstream(strategystream)
strategystream := 0
}

```

```

newgame:
  score1, score2 := 0, 0

  writef("*nNew Game*n")

```

If either player 1 or 2 is the computer playing the optimum strategy, one or both of `a1` and `a2` will be negative. The effect is to allocate an array, `strategybytes`, of 10,000 bytes and initialise it with the values specified in file `pigstrat.txt`. These values correspond to the smallest `ts` value for each `(op,my)` position where the optimum strategy is to hold.

The program continues as follows.

```

UNTIL quitting DO
{ play(1, a1, b1, c1)
  IF quitting BREAK
  play(2, a2, b2, c2)

  IF score1>=100 DO
  { wins1 := wins1 + 1
    writef("*nPlayer 1 wins*n")
  }
  IF score2>=100 DO
  { wins2 := wins2 + 1

```

```

        writef("Player 2 wins")
    }
    IF score1>=100 | score2>=100 DO
    { writef("Player1 scored %i3 games won %i3*n", score1, wins1)
      writef("Player2 scored %i3 games won %i3*n", score2, wins2)

      { writef("Press S or Q ")
        deplete(cos)
        ch := rch()
        IF ch='Q' | ch=endstreamch DO
        { newline()
          RESULTIS 0
        }
        IF ch='S' GOTO newgame
      } REPEAT
    }
}

fin:
  IF strategybytes DO freevec(strategybytes)
  IF strategystream DO endstream(strategystream)
  RESULTIS 0
}

```

This part of the program causes players 1 and 2 to take turns alternately until one of them wins, at which time it outputs which player won, what the bank balances were. It also gives counts of how often each player has won. Pressing Q will terminate the program and pressing S will start a new game.

Input from the keyboard is read using the function `rch` which returns the next key as soon as it is pressed. The call `writes("*b *b")` erases the character that `sardch` echoed. The call `deplete(cos)` causes the buffered output to the currently selected output stream to be flushed, typically to the screen.

```

AND rch() = VALOF
{ LET c = capitalch(sardch())
  writes("*b *b")
  deplete(cos)
  RESULTIS c
}

```

The function `play` performs a player's turn. It is defined as follows.

```

AND play(player, a, b, c) BE UNLESS score1>=100 | score2>=100 DO
{ LET turnscore = 0
  LET done = FALSE

```

```

LET throws = 0
LET turnv = VEC 100

UNLESS a DO writef("Press P, H or S*n")

{ LET score    = score1
  LET opponent = score2

  IF player=2 DO score, opponent := score2, score1

  writef("*cPlayer%n: %i3 opponent %i3 turn %i3=",
         player, score, opponent, turnscore)
  IF throws>0 DO writef("%n", turnv!0)
  FOR i = 1 TO throws-1 DO writef("+%n", turnv!i)

  IF done DO
  { newline()
    TEST player=1
    THEN score1 := score1 + turnscore
    ELSE score2 := score2 + turnscore
    RETURN
  }

  IF strategy(turnscore, score, opponent, a, b, c) DO
  { // Throw
    LET n = randno(6)
    turnv!throws := n
    throws := throws+1
    turnscore := turnscore+n
    IF n=1 DO
    { turnscore := 0
      done := TRUE
    }
    UNLESS score+turnscore >= 100 LOOP
  }
  // Hold
  done := TRUE
} REPEAT
}

```

If either player has already won, `play` returns immediately. Otherwise, it declares some local variables including the vector `turnv` which will hold all the values thrown in the current turn. The variable `throws` holds the number of times the die has been thrown in this turn. The choice of whether to hold or play is computed by the function `strategy` which defined below. As each decision is

made it then outputs a line such as the following.

```
Player1:  14 opponent   23 turn  14=5+3+6
```

inviting the player to choose between another throw or holding. If `done=TRUE` the decision to hold has already been made and so the player's score is updated and play returns. The `strategy` function is defined as follows.

```
AND strategy(turnscore, myscore, opscore, a, b, c) = VALOF
{ // Return TRUE to throw die, otherwise return FALSE.
  UNLESS a RESULTIS userplay()

  UNLESS turnscore RESULTIS TRUE // m/c always throws first time

  // If a<0 use the optimum strategy based on data in pigstrat.txt
  IF a<0 RESULTIS turnscore < strategybytes%(opscore*100+myscore)

  RESULTIS turnscore < a + (myscore*(b-a) + opscore*(c-a))/99
}
```

If `a` is zero, the function `userplay` is called to let the user decide whether to throw or hold. If `a` is negative, the computer used the optimum strategy based on data in `pigstrat.txt`. Otherwise, a machine strategy is chosen based on the parameters `a`, `b` and `c`.

The next function reads the user's choice of whether to throw or play. It switches on the next character of input and takes appropriate action.

```
AND userplay() = VALOF
{ ch := rch()
  SWITCHON ch INTO
  { DEFAULT: LOOP
    CASE 'P': RESULTIS TRUE
    CASE endstreamch:
    CASE 'Q': quitting := TRUE
    CASE 'H': RESULTIS FALSE
    CASE 'S': longjump(newgameP, newgameL)
  }
}
```

A typical run causing the computer to play itself is as follows. Here, strategies `a1=20` and `a2=27` are being compared. Repeatedly pressing `S` shows that the limit of 20 is better than 27.

```

0.010> pig a1 20 a2 27
New Game
Player1:  0 opponent    0 turn    0=4+3+6+1
Player2:  0 opponent    0 turn    21=5+3+3+3+4+3
Player1:  0 opponent   21 turn    0=4+2+6+1
Player2: 21 opponent    0 turn    20=6+2+4+6+2
Player1:  0 opponent   41 turn    0=4+1
Player2: 41 opponent    0 turn    0=1
Player1:  0 opponent   41 turn    21=2+3+3+6+2+5
Player2: 41 opponent   21 turn    20=5+4+3+6+2
Player1: 21 opponent   61 turn    0=1
Player2: 61 opponent   21 turn    22=6+4+4+5+3
Player1: 21 opponent   83 turn    20=3+5+5+3+2+2
Player2: 83 opponent   41 turn    20=6+5+3+6

```

Player 2 wins

```

Player1 scored 41 games won 0
Player2 scored 103 games won 1

```

Press S or Q

4.17.1 The Optimum Strategy

As mentioned above the optimum strategy for the pig dice game is complicated and counter intuitive, and quite hard to discover. The optimum strategy can be represented by a $100 \times 100 \times 100$ cube of values indicating whether it is best to hold or play the die for each state of the game. The program `pigstrategy.b` is my attempt to calculate this optimum strategy, leaving the result in the file `pigcube.txt`.

The triplet `(op,my,ts)` represents a state in the game, where `op` is player2's score, `my` is player1's score and `ts` is player1's current turn score. The optimum strategy for player1 is specified by stating whether to PLAY or HOLD for each state gives the higher probability of winning. Suppose $P(op,my,ts)$ is the probability of player1 winning, then:

`/smallskip`

```

P(op,my,ts) = 0,  if op    >= 100,          // Player1 has lost
              = 1   is my+ts >= 100,      // Player1 has won

              = max( (1 - P(my+ts, op, 0)), // Player1 HOLDS

                    ( (1 - P(my, op, 0))   // Player1 throws a 1
                      + P(op, my, ts+2)    // Player1 throws a 2
                      + P(op, my, ts+3)    // Player1 throws a 3
                      + P(op, my, ts+4)    // Player1 throws a 4

```



```

        + P(op, my, ts+5)      // Player1 throws a 5
        + P(op, my, ts+6)      // Player1 throws a 6
    ) / 6 // Take the average of these six cases.
)

```

We can represent the cube by an array called `cube` with one million ($= 100 \times 100 \times 100$) elements. The element `cube!i` will hold `(prob<<1|flag)`, where `i=op*100*100+my*100+ts`, `prob` holds the probability of a win represented as a scaled number with 8 decimal digits after the decimal point and `flag=1` indicates that the best strategy at this position is to HOLD. As we have seen the setting of `cube!i` depends on the settings of other elements of `cube`, so we essentially have one million simultaneous equations to solve. Using a simple recursive function will fail because the equation for `cube!i` may depend indirectly on its own value, and this will cause a recursive loop that is hard to avoid. So we probably have to resort to a so called relaxation method, in which we make an initial guess for each element of `cube` and then repeatedly update each `cube!i` with a new estimate based on the previous elements of `cube`. In general there is no guarantee that relaxation will converge, but luckily for this problem it converges to a reasonable looking answer rapidly. A program to perform this iteration using a precision of eight digits after the decimal point for the probabilities is called `pigstrategy.b` and a second version using 16 digit precision is called `pigstrategyhd`. They both discover exactly the same optimum strategy. After 51 iterations the strategy does not change and after 95 iterations all the probabilities of winning remain unchanged to eight decimal places. It is worth noting that the order in which the elements of `cube` are updated make a big difference to the rate of convergence of the algorithm, but the resulting optimal strategy should always be the same. The 16 digit version shows us that after 149 iterations the first 12 digits of every probability remains unchanged.

Once the optimum strategy has been found two files are written. The first, called `pigcube.txt` holds the resulting winning probability and flag for every element of the cube. This file is about 13 million bytes long. The second file, called `pigstrat.txt` holds a sequence of 10,000 numbers giving the lowest turn score for which holding is the best strategy for each (opponent score, player score) pair. This is read by the `pig.b` program to allow it to play using the optimum strategy.

A few lines of `pigcube.txt` as generated by `pigstrategy.b` are as follows:

```

...
(21 25 0): 0.56765260P 0.57086016P 0.57421506P 0.57772383P 0.58139457P
(21 25 5): 0.58523565P 0.58925465P 0.59346038P 0.59785324P 0.60244720P
...
(25 21 10): 0.54151407P 0.54654803P 0.55182253P 0.55733909P 0.56310562P
(25 21 15): 0.56908934P 0.57538043P 0.58202627P 0.58898613P 0.59620498P

```

```
(25 21 20): 0.60368852P 0.61128274P 0.61977279H 0.62886120H 0.63796413H
(25 21 25): 0.64700159H 0.65618399H 0.66533814H 0.67442849H 0.68337390H
...
(31 25 0): 0.48526691P 0.48858882P 0.49206411P 0.49569825P 0.49949962P
(31 25 5): 0.50347724P 0.50763997P 0.51199559P 0.51655001P 0.52130443P
...
```

If you run `pigstrategy` with the trace option (`-t`) specified, it will generate considerable output including the following lines.

```
...
(31 25 0):0.48526691P
(21 25 0):0.56765260P (25 21 12):0.55182253P (25 21 13):0.55733909P
(25 21 14):0.56310562P (25 21 15):0.56908934P (25 21 16):0.57538043P
(25 21 10):0.51473309H 0.54151407P => (25 21 10):0.54151407P diff=0.00000000
...
```

These lines were generated when `pigstrategy` was computing a new setting for state (25 21 10) of the cube, that is when the player2's score was 25, the player1's score was 21 and player1's current turn score was 10. The first line indicates that the opponent will win with a probability 0.48526691 if the player1 HOLDS. Note that 31 is the sum of the player1's score (21) and the current turn score (10). This becomes player2's score when he/she begins to play. If the player1 chooses to play the die, we must take the average of six probabilities corresponding to the possible throws of the die. If the number one is thrown, player2 gains the die and has a winning probability of 0.56765260 corresponding to state (21 25 0). Otherwise, the player accumulates in the turn score a value between 2 and 6 with varying probabilities held in states (25 21 12) to (25 21 16). When computing the average, we add 3 before dividing by 6 in order to round the result properly. The last line shows the probability of winning if HOLDing (0.51473309) or continuing to PLAY (0.54151407). The best strategy for this state is therefore to PLAY. This last line also indicates that the new estimated probability of winning is unchanged.

A few lines of `pigstrat.txt` is as follows.

```
...
(25 0):    23  23  23  23  23  23  23  23  23  23
(25 10):   23  23  22  22  22  22  22  21  22  22
(25 20):   22  22  22  22  22  21  21  21  21  20
(25 30):   20  20  20  20  20  20  20  20  19  19
(25 40):   19  19  18  18  18  18  18  19  19  19
...
```

This indicates that when the opponent score is 25 and the player's score is 21, the lowest turn score for which HOLD is the best choice is 22. You will notice that this is compatible with the line starting (25 21 20) from the file `pigcube.txt` where the entry for turn score 22 is 0.61977279H.

A pictorial representation of the optimum strategy is shown in Figure 4.3. The red and green axes identify player1 and player2's current scores and the blue axis holds player1's current turn score. The solid material in the cube represents all the games states where player1's best strategy is to throw the die. Notice that the surface is quite complex and contains some overhangs. The image is based on data in `pigcube.txt` which can be read by a program called `prepcubepic.b` to generate data in the file `cubepic.txt`. This is subsequently read by `plotpigcube.b` to generate the 3D image shown in Figure 4.3. The image is drawn using the SDL Graphics Library and so you should read the next chapter before trying to understand how `plotpigcube.b` works. The programs `pigstrategy.b` and `pigstrategyhd` have recently been modified to display the cube at each step of the relaxation process. This allows you to see the effect of different evaluation orders and different initial settings of the cube elements. The program outputs a checksum of the cube elements to help see whether different versions of the algorithm produce the same result.

4.18 The Enigma Machine

Having recently visited Bletchley Park with my young grandson, I was pleased to see how fascinated he was with the German Enigma Machine used between 1939 and 1945 to encipher messages that were typically transmitted by radio using morse code. Since a program to simulate the machine is quite simple, it is a good programming example with some added interest.

The Allies could easily read the enciphered text so it was necessary to use a cipher code that was impossible to break. The method chosen was to use the Enigma Machine which could translate plain text into enciphered text depending on how the machine was initially set up, and since the machine could be set up in more than 1000 million million ways each generating completely different translations, it was thought to be unbreakable. The machine was battery operated and small and light enough to be used in aircraft, submarines and at the battle front.

The program described in this section simulates the M3 version of the Enigma machine, and its implementation was influenced by a C program written by Fauzan Mirza, and the excellent document and Enigma Machine simulator written by Dirk Rijmenants. For more information, I strongly recommend you visit the following web sites:

<http://users.telenet.be/d.rijmenants>
<http://www.rijmenants.blogspot.com>

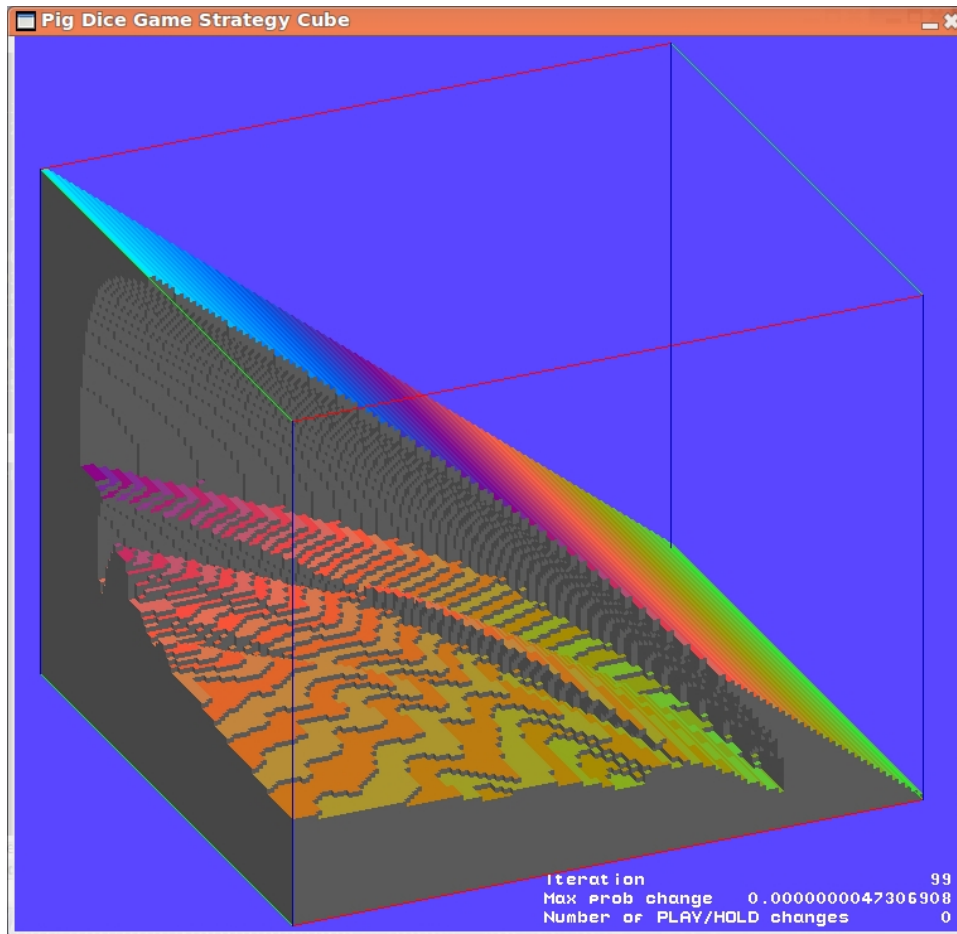

Figure 4.3: The Optimum Strategy for the Pig Dice Game

The machine details and example message have been taken from Rijmenants' document with permission.

The Enigma machine has a keyboard with keys labelled from A to Z and 26 lights labelled A to Z. When a key was pressed one of the lights will turn on indicating the translated letter. The electrical path from the key to the light is complex. It first passes through a plug board which can be set up to swap typically 10 pairs of letters. For instance, one cable could cause A to be turned into J and J to be turned into A. After the plug board, the signal then enters a sequence of three rotors. Each rotor has 26 spring loaded terminals to the right pressing a plate with 26 contacts arranged in a circle. To the right of the rightmost rotor the contact plate is fixed and connected to the 26 wires from the left side of the plug board. The left side of each rotor has a similar circular contact plate that either makes contact with the terminals of the rotor on its left, or, for the left most rotor, the spring loaded terminals of a reflector plate. The reflect connects the letter positions in pairs in an essentially random fashion.

The wiring of each rotor is also essentially random. Once the signal from the pressed key has passed through the plug board and three rotors to the reflector, it returns back through the rotors and plug board to provide power for one of the lights, giving the translated letter. Notice that, because of the way the machine works pressing A, say, will never translate into A. Note also that if pressing A translates to J, say, then, from the same initial setting, pressing J will translate to A. This property allows the machine to be used both to encode messages and decode them.

There is a choice of 5 differently wired rotors (named I, II, III, IV and V) which can be placed in the machine in any order, and there are two possible reflectors named B and C. Before translating a message the correct rotors must be selected and placed in the machine in the required order and each be set to one of 26 initial positions. Each rotor has a small window displaying a letter giving its current position. But this is complicated by the fact that the ring of letters for each rotor can be in any one of 26 positions relative to the its wiring core. These ring settings have to be done before the rotors are placed in the machine.

Every time a key is pressed one or more of the rotors advance by one position completely changing the translation of each letter. So pressing Q, say, repeatedly will generate a seemingly random sequence of letters.

The program for this simulator is in `bcplprogs/raspi/enigma-m3.b`, and since it is quite long and it will be described in small chunks. With some comments removed, it starts as follows.

```
GET "libhdr"

GLOBAL
{ newvec:ug
  spacev; spacep; spacet

  inchar    // String of input characters
  outchar   // String of output characters
  len       // Number of characters in the input string
  ch        // Current keyboard character

  stepping  // =FALSE to stop the rotors from stepping
  tracing   // =TRUE causes signal tracing output

  rotorI;  notchI
  rotorII; notchII
  rotorIII; notchIII
  rotorIV; notchIV
  rotorV;  notchV
  reflectorB
  reflectorC
```

```

rotorLname; rotorMname; rotorRname
reflectormame

// Ring and notch settings of the selected rotors
ringL; ringM; ringR
notchL; notchM; notchR

// Rotor start positions at the beginning of the message
initposL; initposM; initposR
// Rotor current positions
posL; posM; posR;

// The following vectors have subscripts from 0 to 25
// representing letters A to Z
plugboard
rotorFR; rotorFM; rotorFL
reflector
rotorBL; rotorBM; rotorBR // Inverse rotors

// Variables for printing signal path
pluginF
rotorRinF; rotorMinF; rotorLinF
reflin
rotorLinB; rotorMinB; rotorRinB
pluginB; pluginoutB

// Global functions
newvec; setvec
pollrdch; rch; rdlet
rdrotor; rdringsetting
setplugpair; prplugboardpairs; setrotor
step_rotors; rotorfn; encodestr; enigmafn
prsigwiring; prsigreflector; prsigrotor; prsigplug; prsigkbd
prsigline; prsigpath
}

```

This inserts the library declarations from `libhdr` and then declares the global variables required by this program. The first few `newvec`, `spacev`, `spacep` and `spacet` are used in connection with allocation of space. The variables `inchar`, `outchar` and `len` hold the string of message letters, the enciphered translation and the message length. The variable `ch` normally holds the latest character typed by the user.

Two debugging aids are available controlled by `stepping` and `tracing`. If `stepping` is `FALSE` the rotors remain fixed and do not step as each message

character is typed. If `tracing` is `TRUE`, when each message character is typed, the program outputs a diagram showing the signal path within the machine between the pressed key and the resulting light. For instance, with the program's default settings, a `Q` translates to `D` and the output as shown in Figure 4.4.

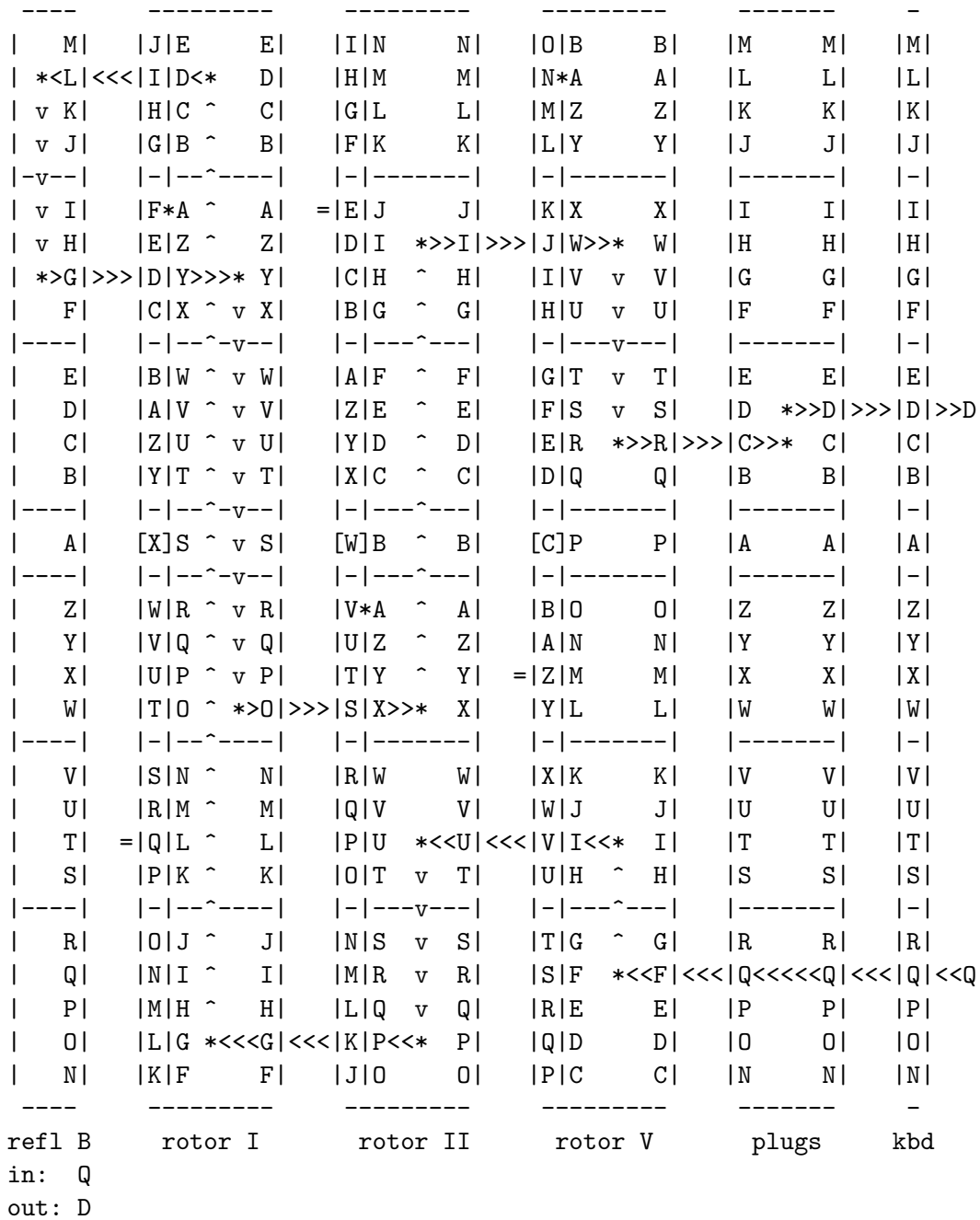

Figure 4.4: Example Signal Path

Notice that the keyboard, plug board, rotors and reflector appear in rectangles with sides composed of horizontal and vertical lines (- and |). The signal path is represented by horizontal (< and >) and vertical (^ and v) arrows, using an asterisks (*) whenever the path turns a right angle. The current letter positions of the three rotors are enclosed in square brackets ([and]). The current positions of the three rotor notches are shown by equal signs to the left of each rotor and the ring setting for each rotor is shown by an asterisk (*) between the ring letter and the letter A on the left side of the wiring core.

The globals `rotorI` to `rotorV` hold strings of length 26 giving the wiring of each of the available rotors. The string for rotor I is "EKMFLGDQVZNTOWYHXUSPAIBRCJ", indicating that the terminal at position A on the right hand side of the rotor is connected to the contact at position E on the left side. Similarly terminal B is connected to contact K.

Each rotor has a circular disc on its left size containing a notch. It is a fixed position relative to the rotor's ring of letters, but this position is different for each rotor. If a rotor has its notch at the A position of the machine then it and the one to its left will both advance by one letter position the next time a key is pressed. This mechanism is covered in more detail on page 107 when the function `step_rotors` is described. The notch positions of each rotor are held in `notchI` to `notchV`. These are given as ASCII characters, for instance `notchI` is set to 'Q'.

The strings representing the wirings of reflectors B and C are held in `reflectorB` and `reflectorC`. The names of the left, middle and right rotors are held as strings in `rotorLname`, `rotorMname` and `rotorRname`, and the name of the current reflector is held in `reflectorname`.

The ring settings and notch positions of the left, middle and right hand rotors are held in `ringL`, `notchL`, `ringM`, `notchM`, `ringR` and `notchR`. These are all numbers in the range 0 to 25 representing A to Z.

The initial position of the left hand rotor (just before the message in `inchar` is processed) is held in `initposL` as a number in the range 0 to 25 representing A to Z, and `initposM` and `initposR` hold the corresponding positions of the middle and right hand rotors. These are needed every time the entire input message is re-enciphered, for instance, whenever one of the machine settings is changed by the user. The current positions of the rotors are held in `posL`, `posM`, `posR`.

For convenience the wiring of the plug board, the rotors and the reflector are held in the vectors `plugboard`, `rotorFR`, `rotorFM`, `rotorFL`, `reflector`, `rotorBL`, `rotorBM` and `rotorBR`. Their subscripts range from 0 to 25 corresponding to positions A to Z, and their elements are in the same range. For instance, if the plug board maps letter A to B, then `plugboard!0` will equal 1. Since the plug board is its own inverse, `plugboard!1` will equal 0. The vector `rotorFR` holds the mapping (in the forward direction) of the letter as it passes through the right hand rotor from right to left. If the right hand rotor is V, it maps B to Z, so `rotorFR!1` is equal to 25. For the return (backward) path from left to right

through this rotor, the letter W maps to R. This is implemented using a second vector called `rotorBR`. Note that `rotorBR!22` will equal 17.

When a key is pressed, the signal path through the plug board, rotors and reflector is computed and recorded in the global variables `pluginF`, `rotorRinF`, `rotorMinF`, `rotorLinF`, `reflin`, `rotorLinB`, `rotorMinB`, `rotorRinB`, `pluginB` and `plugoutB`. These all have values in the range 0 to 25 corresponding to positions A to Z, and are used by the functions that draw the diagram representing the signal path from the pressed key to the corresponding light.

Although not strictly necessary, all the functions in this program are given global locations. This is primarily to aid debugging, since, for instance, it simplifies the setting of break points.

4.18.1 enigma-m3 functions

In this section the functions defined in `enigma-m3.b` are described in turn.

```
LET newvec(upb) = VALOF
{ LET p = spacep - upb - 1
  IF p<spacev DO
    { writef("More space needed*n")
      RESULTIS 0
    }
  spacep := p
  RESULTIS p
}
```

A reasonably sized area of memory is allocated using `getvec` in the main function `start`. The base and limit of this memory are placed in `spacev` and `spacet`. The function `newvec` sub-allocates vectors from this memory by decrementing `spacep` by an appropriate amount each time. The advantage of this scheme is that we can allocate all the memory we need by one call of `getvec` and then return it all by one call of `freevec` just before the program terminates. There is no need to return all the sub-allocated vectors separately.

```
LET setvec(str, v) BE
  IF v FOR i = 0 TO 25 DO v!i := str%(i+1) - 'A'

LET setrotor(str, rf, rb) BE
  IF rf & rb FOR i = 0 TO 25 DO
    { rf!i := str%(i+1)-'A'; rb!(rf!i) := i }
```

These two functions convert the character string versions of rotor and reflector wiring strings to the integer vector form as required by the program. Notice that `setrotor` initialises both the forward and backward wiring vectors for the rotors.

```

LET pollrdch() = VALOF
{ LET ch = sys(Sys_pollsardch)
  UNLESS ch=-3 RESULTIS ch
  delay(100) // Wait 100 msecs and try again
} REPEAT

```

This function uses the call `sys(Sys_pollsardch)` to attempt to read the latest character typed on the keyboard. If no character is available, represented by `-3`, it waits a tenth of a second before trying again. The main reason for using polled input is to get instant response to each character typed on the Enigma Machine.

The next function, `start`, is quite long and so its description is broken into smaller pieces.

```

LET start() = VALOF
{ LET argv = VEC 50

  UNLESS rdargs("-t/s", argv, 50) DO
  { writef("Bad arguments for enigma-m3*n")
    RESULTIS 0
  }

  writef("*nEnigma M3 simulator*n")
  writef("Type ? for help*n*n")

  tracing := TRUE // Default setting of tracing
  IF argv!0 DO tracing := ~tracing // -t/s

  spacev := getvec(1000)
  spacet := spacev+1000
  spacep := spacet

```

When `enigma-m3` is called, it can be given a switch argument `-t` which toggles the tracing option. Currently the default setting is to have tracing enabled. The last three lines allocate some memory, initialising `spacev`, `spacet`, `spacep` appropriately.

```

// Set the rotor and reflector wirings
// and the notch positions.

// Input      "ABCDEFGH IJKLMNOPQRSTUVWXYZ"
rotorI      := "EKMFLGDQVZNTOWYHXUSPAIBRCJ"; notchI   := 'Q'
rotorII     := "AJDKSIRUXBLHWTMCQGZNPYFVOE"; notchII  := 'E'
rotorIII    := "BDFHJLCPRTXVZNYEIWGAKMUSQO"; notchIII := 'V'
rotorIV     := "ESOV PZJAYQUIRHXLNFTGKDCMWB"; notchIV  := 'J'

```

```
rotorV   := "VZBRGITYUPSDNHLXAWMJQOFECK"; notchV   := 'Z'

reflectorB := "YRUHQSLDPXNGOKMIEBFZCWVJAT"
reflectorC := "FVPJIAOYEDRZXWGCTKUQSBMHL"
```

These assignments set the wiring strings of the five rotors and their corresponding notch positions, together with the wiring of the two reflectors.

```
// Allocate several vectors
rotorFL := newvec(25)
rotorFM := newvec(25)
rotorFR := newvec(25)
rotorBL := newvec(25)
rotorBM := newvec(25)
rotorBR := newvec(25)
plugboard := newvec(25)
reflector := newvec(25)
inchar := newvec(255)
outchar := newvec(255)

UNLESS rotorFL & rotorFM & rotorFR &
        rotorBL & rotorBM & rotorBR &
        plugboard & reflector &
        inchar & outchar DO
{ writef("More memory needed")
  GOTO fin
}
```

This code allocates all the vectors needed by the program and places them in their global locations. It checks that they have all been allocated successfully.

```
// Set default encryption parameters, suitable for the
// example message.
```

```
setvec(reflectorB, reflector)
reflectorname := "B"
setrotor(rotorI, rotorFL, rotorBL)
rotorLname, notchL := "I ", notchI - 'A'
setrotor(rotorII, rotorFM, rotorBM)
rotorMname, notchM := "II ", notchII - 'A'
setrotor(rotorV, rotorFR, rotorBR)
rotorRname, notchR := "V ", notchV - 'A'

ringL := 06-1; ringM := 22-1; ringR := 14-1
```

```

initposL := 'X'-'A'; posL := initposL
initposM := 'W'-'A'; posM := initposM
initposR := 'B'-'A'; posR := initposR

FOR i = 0 TO 25 DO plugboard!i := i

// Perform +PO+ML+IU+KJ+NH+YT+GB+VF+RE+DC
// to set the plug board.

setplugpair('P', 'O')
setplugpair('M', 'L')
setplugpair('I', 'U')
setplugpair('K', 'J')
setplugpair('N', 'H')
setplugpair('Y', 'T')
setplugpair('G', 'B')
setplugpair('V', 'F')
setplugpair('R', 'E')
setplugpair('D', 'C')

//writef("Set the example message string*n")

{ LET s = "QBLTWLDAHHEOEFPWYBLENDPMKXLDLFAMUDWIJDXRJZ"
  len := s%0
  FOR i = 1 TO len DO inchar!i := s%i
}

```

This code initialises the Enigma Machine in the way required to decode the following encrypted message.

U6Z DE C 1510 = 49 = EHZ TBS =

```

TVEXS QBLTW LDAHH YEOEF
PTWYB LENDP MKOXL DFAMU
DWIJD XRJZ=

```

It was sent on the 31st day of the month from C to U6Z at 1510 and contains 49 letters. The recipient had the secret daily key sheet containing the following line for day 31:

31 I II V 06 22 14 PO ML IU KJ NH YT GB VF RE DC EXS TGY IKJ LOP

This shows that the enigma machine must be set up with rotors I, II and V in the left, middle and right positions with ring settings 6, 22 and 14, respectively. The plug board should be set with the 10 specified connections.

The rotor start positions should be set to **EHZ** then the three letters **TBS** should be typed. This generates **XWB** which is the start positions of the rotors for the body of the message. The first group **TVEXS** is not enciphered and just confirms we have the right daily key since it contains **EXS** which appears in the daily key sheet, together with two random letters. Decoding begins at the second group **QBLTW**. To decode the example message using this program type the following:

```
QBLTW LDAHH YEOEF PTWYB LENDP MKOXL DFAMU DWIJD XRJZ
```

This generates the following decrypted text (with spaces added).

```
DER FUEHRER IST TOD X DER KAMPF GEHTWEITER X DOENITZ X
```

```
len := 0
stepping := TRUE
ch := '*n'
encodestr()
```

These four lines complete the initialisation of the program. Setting **len** to zero sets the machine to encode letters typed from the keyboard, but if the assignment is commented out the program will decode the example message. The call **encodestr()** encodes all the letters in **inchar** placing their translations in **outchar**.

Now follows the main loop of the simulator. It starts as follows.

```
{ // Start of main input loop
  IF ch='*n' DO { writef("*n> "); deplete(cos); ch := 0 }

  UNLESS ch DO rch()

  SWITCHON ch INTO
  { DEFAULT:
    CASE '*s': ch := 0 // Cause another character to be read.
    CASE '*n': LOOP

    CASE endstreamch:
    CASE '.': BREAK
```

It outputs a prompt, if necessary, and reads the next character from the keyboard unless one is already available. It then switches on this character. The character is ignored if it is a space or has no **CASE** label provided. Dot (.) and the end-of-stream character both cause the program to terminate.

```

CASE '?':
  newline()
  writef("?      Output this help info*n")
  writef("#rst    Set the left, middle and *
          *right hand rotors to r, s and t where*n")
  writef("      r, s and t are single digits *
          *in the range 1 to 5 representing*n")
  writef("      rotors I, II, ..., V.*n")
  writef("!abc    Set the ring positions for the *
          *left, middle and right rotors where*n")
  writef("      a, b and c are letters or numbers *
          *in the range 1 to 26 separated*n")
  writef("      by spaces.*n")
  writef("=abc    Set the initial positions of the *
          *left, middle and right hand rotors*n")
  writef("/B      Select reflector B*n")
  writef("/C      Select reflector C*n")
  writef("+ab    Set swap pairs on the plug board, *
          *a, b are letters.*n")
  writef("      Setting a letter to itself removes *
          *that plug*n")
  writef("|      Toggle rotor stepping*n")
  writef(",      Print the current settings*n")
  writef("letter  Add a message letter*n")
  writef("-      Remove the latest message *
          *character, if any*n")
  writef(".      Exit*n")
  writef("space and newline are ignored*n")
  ch := '*n'
  LOOP

```

This causes some help information to be output when the user types a question mark.

```

CASE '#': // Select the rotors, eg #125
  { LET str, name, notch = 0, 0, 0
    ch := 0
    rdrotor(@str)
    setrotor(str, rotorFL, rotorBL)
    rotorLname, notchL := name, notch-'A'
    rdrotor(@str)
    setrotor(str, rotorFM, rotorBM)
    rotorMname, notchM := name, notch-'A'
    rdrotor(@str)
    setrotor(str, rotorFR, rotorBR)
  }

```

```

rotorRname, notchR := name, notch-'A'
writef("*nRotors: %s %s %s notches %c%c%c*n",
       rotorLname, rotorMname, rotorRname,
       notchL+'A', notchM+'A', notchR+'A')
encodestr()
ch := '*n'
LOOP
}

```

This reads a command of the form *#abc* where *a*, *b* and *c* are digits in the range 1 to 5 representing rotor numbers. It specifies which rotors should be placed in the left, middle and right hand positions. Note that the assignment `ch:=0` forces `rdrotor` to call `rch` to read the next keyboard character. The call `rdrotor(@str)` reads the next rotor number and sets the local variables `str`, `name` and `notch` to the wiring string, the rotor name and its notch letter, respectively. Three calls of `rdrotor` are made to obtain the appropriate settings for the three rotors.

```

CASE '!': // Set ring positions, eg !6 22 14 or !fvn
ch := 0
ringL := rdringsetting()
ringM := rdringsetting()
ringR := rdringsetting()
writef("*nRing settings: %c%c%c*n",
       ringL+'A', ringM+'A', ringR+'A')
encodestr()
ch := '*n'
LOOP

```

This reads a command of the form *!abc* where *a*, *b* and *c* are ring positions given as letters or numbers in the range 1 to 26 separated by spaces. They correspond to the ring settings of the rotors in the left, middle and right hand positions.

```

CASE '=': // Set the rotor positions
ch := 0
initposL := rdlet() - 'A'
initposM := rdlet() - 'A'
initposR := rdlet() - 'A'
writef("*nRotor positions: %c%c%c*n",
       initposL+'A', initposM+'A', initposR+'A')
encodestr()
ch := '*n'
LOOP

```

This reads a command of the form =*abc* where *a*, *b* and *c* are rotor positions given as letters. They correspond to the positions of the left, middle and right hand rotors.

```

CASE '/': // Set reflector B or C
  { rch()
    IF ch = 'B' DO
      { setvec(reflectorB, reflector)
        reflectorname := "B"
        BREAK
      }
    IF ch = 'C' DO
      { setvec(reflectorC, reflector)
        reflectorname := "C"
        BREAK
      }
    writef("*nB or C required*n")
  } REPEAT

writef("*nReflector %s selected*n", reflectorname)
encodestr()
ch := '*n'
LOOP

```

The commands /B and /C select which reflector to use.

```

CASE '+': // Set a plug board pair
  { LET a, b = ?, ?
    rch()
    a := ch
    rch()
    b := ch
    IF 'A'<=a<='Z' & 'A'<=b<='Z' DO
      { setplugpair(a, b)
        BREAK
      }
    writef("*n+ should be followed by two *
           *letters, eg +AB*n")
  } REPEAT

encodestr()
ch := '*n'
LOOP

```

A command of the form `+ab` where *a* and *b* are letters sets a cable between letters *a* and *b*. But if *a* and *b* are the same letter, any cable between *a* and another letter is removed. It calls `setplugpair` to deal with these cases.

```

CASE '|': // Toggle rotor stepping
stepping := ~stepping
TEST stepping
THEN writef("\nRotor stepping enabled\n")
ELSE writef("\nRotor stepping disabled\n")
ch := '*n'
LOOP

```

This case just toggles the rotor stepping option.

```

CASE ',': // Output the settings
newline()
writef("Rotors:           %s %s %s\n",
      rotorLname, rotorMname, rotorRname)
writef("Notches:           %c %c %c\n",
      notchL+'A', notchM+'A', notchR+'A')
writef("Ring setting:       %c-%z2 %c-%z2 %c-%z2\n",
      ringL+'A', ringL+1,
      ringM+'A', ringM+1,
      ringR+'A', ringR+1)
writef("Initial positions: %c %c %c\n",
      initposL+'A', initposM+'A', initposR+'A')
writef("Current positions: %c %c %c\n",
      posL+'A', posM+'A', posR+'A')
writef("Plug board:         ")
prplugboardpairs()

writes("in: "); FOR i = 1 TO len DO wrch(inchar!i)
newline()
writes("out: "); FOR i = 1 TO len DO wrch(outchar!i)
newline()
ch := '*n'
LOOP

```

This case outputs the current settings of the machine, namely which rotors have been selected, what their notch and ring positions are, what the initial and current rotor positions are, what the plug board connections have been made, what the current message is and its encoding. Typical output is as follows:

```

> ,
Rotors:          I   II  V
Notches:         Q E Z
Ring setting:    F-06 V-22 N-14
Initial positions: X W B
Current positions: X W D
Plug board:      BG CD ER FV HN IU JK LM OP TY
in:  QQ
out: DJ

```

```

CASE '-': // Remove one message character
          IF len>0 DO len := len-1
          encodestr()
          ch := '*n'
          LOOP

```

The command minus (-) removes one letter from the input message and then re-encode the entire message just in case tracing was enabled.

```

CASE '~': // Toggle signal tracing
          tracing := ~tracing
          TEST tracing
          THEN writef("\nSignal tracing now on*n")
          ELSE writef("\nSignal tracing turned off*n")
          ch := '*n'
          LOOP

```

The twiddles (~) command toggles the tracing option.

```

CASE 'A':CASE 'B':CASE 'C':CASE 'D':CASE 'E':
CASE 'F':CASE 'G':CASE 'H':CASE 'I':CASE 'J':
CASE 'K':CASE 'L':CASE 'M':CASE 'N':CASE 'O':
CASE 'P':CASE 'Q':CASE 'R':CASE 'S':CASE 'T':
CASE 'U':CASE 'V':CASE 'W':CASE 'X':CASE 'Y':
CASE 'Z':
          IF len<255 DO len := len + 1
          inchar!len := ch
          encodestr()
          ch := '*n'
          LOOP

```

If a letter is typed, it is added to the end of the message string and then the entire message re-encoded by a call of `encodestr`. Notice that the message cannot grow to a length greater than 255 letters.

```

    }
  } REPEAT

  newline()

fin:
  IF spacev DO freevec(spacev)

  RESULTIS 0
}

```

These last few lines end the SWITCHON command and the main command loop. Before returning from the main function `start`, it returns to free store the memory, if any, pointed to by `spacev`.

```

AND setplugpair(a, b) BE
{ // a and b are capital letters
  LET c = ?
  a := a - 'A'
  b := b - 'A'
  c := plugboard!a
  UNLESS plugboard!a = a DO
  { // Remove previous pairing for a
    plugboard!a := a
    plugboard!c := c
  }
  c := plugboard!b
  UNLESS plugboard!b = b DO
  { // Remove previous pairing for b
    plugboard!b := b
    plugboard!c := c
  }
  UNLESS a=b DO
  { // Set swap pair (a, b).
    plugboard!a := b
    plugboard!b := a
  }
}
}

```

This function is used by the plus (+) command to place a plug board cable between letters `a` and `b`, which are given as character constants in the range 'A' to 'Z'. If `a` and `b` are equal, any previous cable to `a` is removed.

```

AND rdlet() = VALOF

```

```

{ IF ch=0 DO rch()
  WHILE ch='*s' DO rch()
  IF 'A'<=ch<='Z' DO
  { LET res = ch
    ch := 0
    RESULTIS res
  }
  writef("*nA letter is required*n")
  ch := 0
} REPEAT

```

```

AND rch() BE
{ // Read a keyboard key as soon as it is pressed.
  ch := capitalch(pollrdch())
  wrch(ch)
  deplete(cos)
}

```

The function `rdlet` reads a letter from the keyboard, and `rch` reads any character from the keyboard, replacing lower case letters by their upper case equivalents.

```

AND rdrotor(v) BE
{ // Returns the rotor wiring string
  // result2 is the rotor name: I, II, III, IV or V
  IF ch=0 DO rch()
  WHILE ch='*s' DO rch()

  IF '0'<=ch<='5' DO
  { IF ch='1' DO v!0, v!1, v!2 := rotorI, "I ", notchI
    IF ch='2' DO v!0, v!1, v!2 := rotorII, "II ", notchII
    IF ch='3' DO v!0, v!1, v!2 := rotorIII, "III", notchIII
    IF ch='4' DO v!0, v!1, v!2 := rotorIV, "IV ", notchIV
    IF ch='5' DO v!0, v!1, v!2 := rotorV, "V ", notchV
    ch := 0
    RETURN
  }
  writef("*nRotor number not in range 1 to 5*n")
  ch := 0
} REPEAT

```

This function reads a digit in the range 1 to 5 and sets `v!0`, `v!1` and `v!2` to the wiring string, the name and the notch letter of the specified rotor.

```

AND rdringsetting() = VALOF
{ // Return 0 to 25 representing ring setting A to Z
  IF ch=0 DO rch()

  WHILE ch='*s' DO rch()

  IF 'A'<=ch<='Z' DO
  { LET res = ch-'A'
    ch := 0
    RESULTIS res
  }

  IF '0'<= ch <= '9' DO
  { LET n = ch-'0'
    rch()
    IF '0'<= ch <= '9' DO n := 10*n + ch - '0'
    // n = 1 to 26 represent ring settings of A to Z
    // encoded as 0 to 25
    ch := 0
    IF 1<=n<=26 RESULTIS n - 1
    writef("*nA letter or a number in range 1 to 26 required*n")
  }
} REPEAT

```

This function reads a ring setting as either a letter or a number in the range 1 to 26. It returns a value in the range 0 to 25.

```

AND prplugboardpairs() BE FOR a = 0 TO 25 DO
{ // Print plug board pairs in alphabetical order
  LET b = plugboard!a
  IF a < b DO writef("%c%c ", a+'A', b+'A')
}

```

This function outputs the current wiring of the plug board as letter pairs in alphabetic order.

```

AND step_rotors() BE IF stepping DO
{ LET advM = posR=notchR | posM=notchM
  LET advL = posM=notchM

  posR := (posR+1) MOD 26 // Step the right hand rotor
  IF advM DO posM := (posM+1) MOD 26 // Step the middle rotor
  IF advL DO posL := (posL+1) MOD 26 // Step the left rotor
}

```

Whenever a key is pressed one or more rotors advance by one letter position. Each rotor has a notch disk attached to the letter ring on its left side. A notch is shaped like an asymmetric V with one edge on a radius line towards the centre of the rotor and the other at an angle of about 70 degrees forming a gentle slope back to the rim of the disk. On the right hand side of each rotor there is a disk, we will call the ratchet disk, containing 26 equally spaced notches of similar shape. Between the middle and right hand rotors there is a spring loaded pawl that is typically just clear of the rim of the notch disk to its right. When a key is pressed, the pawl is pushed towards the notch disk and advances by one letter position. Normally, the notch disk is not in its notch position so the pawl will rest on the rim and slides without moving the rotor. The rim will also hold the pawl clear of the notches on the ratchet disk on its left, so the middle rotor will not be moved. If, on the other hand, the right hand rotor is at its notch position, the pawl will fall into the notch and will also engage a notch in the ratchet disk of the middle rotor causing both rotors to advance. As the key is released the pawl will slide up the gentle slope of both notches and eventually be lifted clear of the both disks.

There are pawls positioned just to the right of each of the three rotors. The pawl between the left and middle rotors behaves just like the pawl between the middle and right hand rotors, but the pawl on the right of the right hand rotor will always engage its ratchet disk causing this to advance on every key stroke.

If the right hand rotor is in its notch position, the next key stroke will advance both the right hand and middle rotors. If the middle rotor is now in its notch position, the next key stroke will advance both the middle and left hand rotors. Notice that, in this situation, the middle rotor advances on two consecutive key strokes. You can observe this double stepping behaviour by selecting rotors III, II and I (#321) whose notch positions are V, E and Q, and setting the rotor positions to KDO (=KDO) before typing a few letters with tracing turned on.

In the above function, the variable `advM` is set to `TRUE` if the middle rotor advances on the current key stroke and similarly `advL` is `TRUE` if the left hand rotor advances at the same time. Notice that `advM` is `TRUE` if either `posR=notchR` or `posM=notchM`, and `advL` is only `TRUE` if `posM=notchM`. Rotors are advanced by adding one to their positions held in `posL`, `posM` or `posR`. The addition of `MOD 26` deals with the situation of a rotor advancing from its Z to A positions.

When no key is being pressed, the pawls are clear of the notch disks and the rotors can be rotated forward or backwards by hand.

```
AND encodestr() BE
{ // Set initial state
  posL, posM, posR := initposL, initposM, initposR
  // The rotor numbers and ring settings are already set up.
  IF len=0 RETURN
```

```

FOR i = 1 TO len DO
{ LET x = inchar!i - 'A'           // letter to encode
  IF stepping DO step_rotors()
  outchar!i := enigmafn(x) + 'A'
}
TEST tracing
THEN prsigpath()
ELSE writef(" %c", plugoutB+'A')
}

```

This function causes the entire message in `inchar` to be encrypted, updating `outchar` appropriately. It does this by initialising `posL`, `posM` and `posR` to `initposL`, `initposM` and `initposR`, then successively calling `enigmafn` giving it each character of the input message. If `tracing` is `TRUE` it then outputs a diagram showing the electrical path through the plug board, rotors and reflector used to encode the final character, otherwise it just outputs the final encrypted character.

The next two functions implement the encryption mechanism of the enigma machine, as you will see these functions are quite simple.

```

AND enigmafn(x) = VALOF
{ // Plug board
  pluginF := x
  rotorRinF := plugboard!pluginF
  // Rotors right to left
  rotorMinF := rotorfn(rotorRinF, rotorFR, posR, ringR)
  rotorLinF := rotorfn(rotorMinF, rotorFM, posM, ringM)
  reflin    := rotorfn(rotorLinF, rotorFL, posL, ringL)
  // Reflector
  rotorLinB := reflector!reflin
  // Rotors left to right
  rotorMinB := rotorfn(rotorLinB, rotorBL, posL, ringL)
  rotorRinB := rotorfn(rotorMinB, rotorBM, posM, ringM)
  pluginB   := rotorfn(rotorRinB, rotorBR, posR, ringR)
  // Plugboard
  plugoutB := plugboard!pluginB

  RESULTIS plugoutB
}

```

The argument `x` is a number in the range 0 to 25 representing a letter position of an active signal within the machine. This signal must first pass through the plug board, emerging at position `plugboard!x`. So that the path through the machine of the active signal can be drawn, its position between components is

saved in global variables such as `pluginF` and `rotorRinF`. Generally speaking `F` indicates a signal travelling in the forward direction (from right to left) and `B` indicates travel in the backwards direction (from left to right). The signal entering the right hand rotor in the forward direction is held in `rotorRinF` and it leaves this rotor in position `rotorMinF`. The computation is done by a call of `rotorfn` which takes four arguments giving the input position, the appropriate wiring vector, the position of the rotor and its ring setting. The function `rotorfn` is described below. The signal from the right hand rotor then passes through the middle rotor and the left hand rotor, emerging at position `reflin`. The signal then re-enters the left hand rotor at position `rotorLinB` that was computed by the expression `reflector!refin`. The signal then passes back through the rotors via positions computed by three calls of `rotorfn` before re-entering the plug board at position `pluginB`. Since the plug board is its own inverse its effect can be computed using `plugboard!pluginB` to give `plugoutB` which is the position of the light identifying the encrypted letter. This position is returned as the result of `enigmafn`.

```

AND rotorfn(x, map, pos, ring) = VALOF
{ LET a = (x+pos-ring+26) MOD 26
  LET b = map!a
  LET c = (b-pos+ring+26) MOD 26
  RESULTIS c
}

```

As explained above, each rotor has a wiring core that connects terminals on its right hand side to contacts on the left. Each of the five available rotors have their own wiring specified by strings held in the variables `rotorI` to `rotorV`. When the rotors have been selected their wiring maps will have been placed in vectors such as `rotorFR` and `rotorBR`. Here, `rotorFR` gives the map specifying how the signal passes through the right hand rotor from right to left. If the wiring core has its `A` position aligned with the `A` position of the machine, then the signal will emerge at position `rotorFR!x` where `x` is the machine position of the signal entering the right hand rotor from the right. But the rotational position of the rotor depends on its position (`posR`) as displayed in the rotor's little window, and on its ring setting. As the rotor steps forward from, for instance, `A` to `B`, its wiring core rotates anti-clockwise by one position when viewed from the right. So we should add `posR` to `x` before computing `rotorFR!x`. If the ring position is `B` rather than `A` the wiring core is effectively rotated clockwise when viewed from the right, and so we must subtract `ringR` from `x` before the lookup. To deal with the boundary between `Z` and `A` we must add 26 and take the remainder after division by 26. The addition of 26 ensures that the left hand operand of `MOD` is positive. The appropriate position within the map is thus $(x+pos-ring+26) \text{ MOD } 26$ which is placed in variable `a`. The result of

the lookup is then placed in `b` by the declaration `LET b = map!a`. This gives a position relative to the `A` position of the wiring core. The corresponding position within the machine is $(b - \text{pos} + \text{ring} + 26) \text{ MOD } 26$ which becomes the result of `rotorfn`. With suitable arguments this function can be used to compute the effect of each of the three rotors in both the forward and backward directions.

What remains are the functions that generate the ASCII graphics representation of the signal path showing how any given input letter generates the corresponding encrypted letter. Even though it now all looks fairly straightforward, it did take longer to design and implement than all of the rest of `enigma-m3.b`.

As can be seen in the wiring diagram in Figure 4.4 on page 93 it consists of several blocks placed side by side representing the reflector, the three rotors, the plug board and the keyboard/lights block. Each has edges drawn using vertical bars (`|`) and minus signs (`-`) and separated from each other by three spaces. The signal path has a direction and is drawn using the characters `<`, `>`, `^`, `v`. An asterisk (`*`) is used whenever the path turn a right angle.

The diagram contains 26 lines numbered 0 to 25 from bottom to top with the convention that line 13 corresponds to the `A` position within the machine. To improve readability some spacer lines consisting mainly of minus signs and vertical bars have been added. Each spacer line has the same line number as the letter line just above it. The diagram is drawn using `prsigpath` whose definition is as follows.

```
AND prsigpath() BE
{ newline()
  prsigline(26, TRUE)
  prsigline(25, FALSE)
  prsigline(24, FALSE)
  prsigline(23, FALSE)
  prsigline(22, FALSE)
  prsigline(22, TRUE)
  prsigline(21, FALSE)
  prsigline(20, FALSE)
  prsigline(19, FALSE)
  prsigline(18, FALSE)
  prsigline(18, TRUE)
  prsigline(17, FALSE)
  prsigline(16, FALSE)
  prsigline(15, FALSE)
  prsigline(14, FALSE)
  prsigline(14, TRUE)
  prsigline(13, FALSE)
  prsigline(13, TRUE)
  prsigline(12, FALSE)
  prsigline(11, FALSE)
```

```

prsigline(10, FALSE)
prsigline( 9, FALSE)
prsigline( 9, TRUE)
prsigline( 8, FALSE)
prsigline( 7, FALSE)
prsigline( 6, FALSE)
prsigline( 5, FALSE)
prsigline( 5, TRUE)
prsigline( 4, FALSE)
prsigline( 3, FALSE)
prsigline( 2, FALSE)
prsigline( 1, FALSE)
prsigline( 0, FALSE)
prsigline( 0, TRUE)
writef("refl %s ", reflectorname)
writef("  rotor %s ", rotorLname)
writef("  rotor %s ", rotorMname)
writef("  rotor %s ", rotorRname)
writef("  plugs  ")
writef("  kbd*n")
writes("in:  "); FOR i = 1 TO len DO wrch(inchar!i)
newline()
writes("out: "); FOR i = 1 TO len DO wrch(outchar!i)
newline()
}

```

Each line is drawn by calls of `prsigline` whose first argument is the line number, and whose second argument specifies whether or not it is a spacer line. The top and bottom space lines are drawn by the calls `prsigline(26,TRUE)` and `prsigline(0,TRUE)`. Below the bottom line, labels are written giving the names of the reflector, the rotors, the plug board and the keyboard. Below this there are two lines giving the message text and its encryption.

Each line in the wiring diagram contains characters representing a line through the reflector, the three rotors, the plug board and the keyboard/lights. These are drawn by calls of `prsigline` whose definition is as follows.

```

AND prsigline(n, sp) BE
{ prsigreflector(n, sp, reflin, rotorLinB)
  prsigrotor(n, sp, posL, ringL, notchL,
             rotorLinF, reflin, rotorLinB, rotorMinB)
  prsigrotor(n, sp, posM, ringM, notchM,
             rotorMinF, rotorLinF, rotorMinB, rotorRinB)
  prsigrotor(n, sp, posR, ringR, notchR,
             rotorRinF, rotorMinF, rotorRinB, pluginB)
  prsigplug(n, sp, pluginF, rotorRinF, pluginB, pluginB)
}

```

```

    prsigkbd(n, sp, pluginF, pluginB)
    newline()
}

```

As can be seen, the parts of the line corresponding to the reflector, the rotors, the plug board and the keyboard are drawn using suitable calls of `prsigreflector`, `prsigrotor`, `prsigplug` and `prsigkbd`. The functions are defined below.

```

AND prsigreflector(n, sp, inF, outB) BE
{ LET iF = (inF +13) MOD 26
  LET oB = (outB +13) MOD 26
  LET letter = (n+13) MOD 26 + 'A'
  LET c0, c1, c2, c3 = '|', ' ', ' ', ' '
  LET c4, c5, c6 = letter, '|', ' '

  TEST sp
  THEN { c1,c2,c3,c4 := '-','-', '-','-'
        IF iF<n<oB DO c2 := '^'
        IF iF>n>oB DO c2 := 'v'
        IF n=0 | n=26 DO c0,c5 := ' ',' '
      }
  ELSE { IF iF=n | oB=n DO c2 := '**'
        IF iF<n<oB DO c2 := '^'
        IF iF>n>oB DO c2 := 'v'
        IF iF=n DO c3,c6 := '<','<'
        IF oB=n DO c3,c6 := '>','>'
      }
  writef("%c%c%c%c%c%c%c", c0,c1,c2,c3,c4,c5,c6)
}

```

The arguments `n` and `sp` give the line number to be drawn and whether it is a spacer line or not, and `inF` and `outB` are in the range 0 to 25 representing A to Z, specifying the machine positions of the input and output signals to the reflector.

The declaration `LET iF = (inF+13) MOD 26` converts the input signal position to a line number, and the declaration of `oB` does the same for the output signal. The declaration `LET letter = (n+13) MOD 26 + 'A'` converts the line number to the letter representing the machine position of the line. By convention line 13 corresponds to A.

The variables `c0` to `c6` will hold characters representing the line of the reflector to be drawn. Normally `c0` and `c5` hold vertical bars for the left and right edges of the reflector, `c1` is normally a space and `c2` is used to represent a wire joining the input and output signal positions. It is thus normally a space character or one of `^`, `v` or `*`. Normally `c3` and `c6` hold spaces but can be set to `<` or `>` to

represent a signal entering or leaving the reflector. The letter position within the machine is held in `c4`.

The `TEST` command then adjusts these settings mainly depending on whether a spacer line is being drawn and the relative positions of the line and the input and output positions. Finally, it outputs the characters using a `writef` statement, duplicating `c6` for readability.

Drawing a line of a rotor is more complicated since it is necessary to draw signal wires for the forward and backward paths as well as showing the rotor and notch positions, and the ring setting. This is done by the function `prsigrotor` defined as follows.

```

AND prsigrotor(n, sp, pos, ring, notch,
              inF, outF, inB, outB) BE
{ LET iF   = (inF+13)          MOD 26
  LET iB   = (inB+13)          MOD 26
  LET oF   = (outF+13)         MOD 26
  LET oB   = (outB+13)         MOD 26
  LET nch  = (notch-pos+13+26) MOD 26
  LET rng  = (ring-pos+13+26)  MOD 26
  LET let1 = (n+pos+13+26)     MOD 26 + 'A'
  LET let2 = (n+pos-ring+13+26) MOD 26 + 'A'
  LET c0,c1,c2,c3,c4,c5 = ' ', '|', let1, '|', let2, ' '
  LET c6,c7,c8,c9 = ' ', let2, '|', ' '

  TEST sp
  THEN { c2,c3,c4,c5,c6,c7 := '-','|','-','-','-','-','-','-','- '-
        IF n=0 | n=26 DO c1,c3,c8 := ' ','-','-',' '
      }
  ELSE { IF n=iF DO c6,c9 := '<','<'
        IF n=oB DO c6,c9 := '>','>'
        IF n=oF DO c0,c5 := '<','<'
        IF n=iB DO c0,c5 := '>','>'
        IF n=nch DO c0 := '='
        IF n=rng DO c3 := '**'
        IF n=13 DO c1,c3 := '[' , ']'
      }
  writef("%c%c%c%c%c%c", c0,c1,c2,c3,c4,c5)
  prsigwiring(n, sp, iF, oF, iB, oB)
  writef("%c%c%c%c%c", c6,c7,c8,c9,c9)
}

```

The forward and backward input and output positions are specified by the arguments `inF`, `outF`, `inB` and `outB`. These are in the range 0 to 25 representing A to Z. The declaration `LET iF = (inF+13) MOD 26` converts `inF` to a line

number in the wiring diagram, with the convention line 13 corresponds to A. The variable `iB`, `oF`, `oB` are similarly defined. The variable `nch` holds the line number corresponding to the position of the rotor's notch, and `rng` is the line number corresponding to the A position of the rotor's wiring core. The letter on the rotor's ring corresponding to the current line is held in `let1`, and wiring core letter corresponding to the current line is held in `let2`.

The variables `c0` to `c9` will hold characters representing the current line in the rotor. The notch position is represented by an equal sign (=) in `c0`. If this is line 13 then the rotor is at its notch position and the next key press will advance the rotor on its left. Normally, `c0` is not an equal sign it will hold a space unless a signal enters or leaves on this line, in which case it will hold either < or >. The rotor's ring of letters has a letter in `c2` normally surrounded by vertical bars in `c1` and `c3`, but we are on line 13 it will be surrounded by square brackets to indicate that the letter is in the rotor's little window. If the letter corresponds to the ring setting, `c3` holds an asterisk (*). The variables `c4` and `c8` normally hold `let2`, the letter on the wiring core corresponding to this line. The routing of the two wires in the wiring core occupies three character positions between `c5` and `c6`. These are written by a call of `prsigwiring` which is defined below. The entry and exit positions are marked using < and > in `c5` and `c6`. The right hand edge of the rotor is marked by a vertical bar in `c8`, and the signal entering or leaving the rotor on the right is marked by either < or > in `c9`., which is duplicated for readability.

The initial settings of these character variables are adjusted by the `TEST` command. For spacer lines the correction is simple, and for non spacer lines attention is paid to input and output positions of signals, the notch and ring positions and whether the ring letter is displayed in the rotor's little window.

The plug board is similar to a rotor in that it requires the routing of two wires which may cross each other. This routing is again done using `prsigwiring`, otherwise dealing with the plugboard is simple. The definition of `prsigplug` is as follows.

```

AND prsigplug(n, sp, inF, outF, inB, outB) BE
{ LET iF = (inF +13) MOD 26
  LET oF = (outF+13) MOD 26
  LET iB = (inB +13) MOD 26
  LET oB = (outB+13) MOD 26

  LET letter = (n+13) MOD 26 +'A'
  LET c0,c1,c2,c3 = ' ', '|', letter, ' '
  LET c4,c5,c6,c7 = ' ', letter, '|', ' '

  TEST sp
  THEN { c2,c3,c4,c5 := '-','-','-','-'
```

```

        IF n=0 | n=26 DO c1,c6,c7 := ' ',' ',' '
    }
ELSE { IF n=iF DO c4,c7 := '<','<'
      IF n=oF DO c0,c3 := '<','<'
      IF n=iB DO c0,c3 := '>','>'
      IF n=oB DO c4,c7 := '>','>'
    }
writef("%c%c%c%c", c0,c1,c2,c3)
prsigwiring(n, sp, iF,oF,iB,oB)
writef("%c%c%c%c%c%c", c4,c5,c6,c7,c7,c7)
}

```

As with `prsigrotor`, the variables `iF`, `oF`, `iB` and `oB` are declared to give the line numbers of these signals. The edges are marked by vertical bars in `c1` and `c6`. The letter position is duplicated in `c2` and `c5`. The entry and exit positions to the wiring is marked by `<` or `>` in `c4` and `c5`. Much of the coding is similar to that used in `prsigrotor`.

Finally, the keyboard and lights are dealt with `prsigkbd` whose definition is as follows.

```

AND prsigkbd(n, sp, inF, outB) BE
{ LET iF = (inF +13) MOD 26
  LET oB = (outB+13) MOD 26
  LET letter = (n+13) MOD 26 + 'A'
  LET c0,c1,c2 = '|',letter,'|'

  IF sp DO
  { c1 := '-'
    IF n=0 | n=26 DO c0,c2 := ' ',' '
  }

  writef("%c%c%c", c0,c1,c2)
  IF n=iF UNLESS sp DO { writef("<<%c", letter); RETURN }
  IF n=oB UNLESS sp DO { writef(">>%c", letter); RETURN }
}

```

This is particularly simple because it just outputs the machine letter positions surrounded by vertical bars, and marks which key was pressed and which encrypted letter was generated by writing strings such as `<<Q` and `>>D` to the right of the keyboard.

The routing of wires in the rotors and the plug board is done by `prsigwiring`. It is quite long since there are many separate cases to deal with. Its definition starts as follows.

```

AND prsigwiring(n, sp, iF, oF, iB, oB) BE
{ // iF, oF, iB and oB are in the range 0 to 25 representing
  // line numbers within the wiring diagram of the forward and
  // backward input and output signals.

  LET Flo,Fhi,Blo,Bhi = iF,oF,iB,oB
  LET aF, aB = '^','v'
  LET c1,c2,c3=' ',' ',' '

  IF iF>oF DO Flo,Fhi,aF := oF,iF,'v'
  IF iB>oB DO Blo,Bhi,aB := oB,iB,'v'
  // aF and aB = ^ or v giving the vertical direction
  //           for the forward and backward paths.
  // n = the line number in range 0 to 26
  //     with the convention n=13 corresponds to position A
  // sp = TRUE for spacer lines
  // c1, c2 and c3 are for the three wiring characters
  //           for this line.

```

The arguments *n* and *sp* specify the line number and whether the line is a spacer. The remaining arguments *iF*, *oF*, *iB* and *oB* give the line numbers of the forward and backward entry and exit positions. The variables *Flo*, *Fhi*, *Blo* and *Bhi* are declared and initialised to the smaller and larger values of *iF*, *oF*, *iB* and *oB*, and *aF* and *aB* are declared and initialised to hold *^* and *v* to indicate the vertical direction of the forward and backward wires. These are used in many places in the code that follows.

The variables *c1*, *c2* and *c3* will hold the routing of the signals, if any, through the current line. There are many cases to consider and these will be taken in turn.

```

IF sp DO
{ // Find every spacer line containing no wires.
  IF n>Fhi & n>Bhi |
    n<=Flo & n<=Blo |
    Bhi<n<=Flo      |
    Fhi<n<=Blo      DO
  { writef("---") // Draw a spacer line with no wires.
    RETURN
  }
  c1,c2,c3 := '-','-','- '
}

```

This tests to see if the current line is a spacer line containing no wires, and if so just outputs three minus signs (---). A spacer line that does contain wires has the default setting of *c1* to *c3* changed from spaces to minus signs.

```

// Find all non spacer lines containing no wires.
IF n>Fhi & n>Bhi |
    n<Flo & n<Blo |
    Bhi<n<Flo      |
    Fhi<n<Blo      DO
{ // Non spacer line at position n contains no wires.
  writef("   ")
  RETURN
}

```

This code deals with non spacer lines containing no wires by simply outputting three spaces and returning from `prsigwiring`.

From now on we know there is at least one signal wire passing through this line.

```

IF Flo>Bhi |
    Blo>Fhi DO
{ // There is only one wire at this region so
  // the middle column can be used.
  UNLESS sp DO
  { IF iF=n=oF DO { writef("<<<"); RETURN }
    IF iB=n=oB DO { writef(">>>"); RETURN }
    // Position n has an up or down going wire.
    IF n=iF DO { writef(" **<"); RETURN }
    IF n=oF DO { writef("<** "); RETURN }
    IF n=iB DO { writef(">** "); RETURN }
    IF n=oB DO { writef(" **>"); RETURN }
  }
  IF Flo<n<=Fhi DO c2 := aF
  IF Blo<n<=Bhi DO c2 := aB

  writef("%c%c%c", c1, c2,c3)
  RETURN
}

```

We now know there is at least one wire passing through this line, so we test for the special case of the forward wire being entirely above or entirely below the backward wire. If this happens both wires can be routed along the middle column, namely `c2`. We must deal with signals that enter or leave on this line, and we must also check whether the signal both enters and leaves on this line, necessitating `<<<` or `>>>`. The general case is to conditionally plant the appropriate vertical arrow in `c2`.

```

IF iB<oF<iF & oB<iF |

```



```

    iF<oB & iF<oF<iB DO
{ TEST sp
  THEN { // This is a spacer line
        // so only contains vertical wires
        IF Flo<n<=Fhi DO c1 := aF
        IF Blo<n<=Bhi DO c3 := aB
      }
  ELSE { // This is a non spacer line
        IF n=iF DO c1,c2,c3 := '**','<','<'
        IF n=oF DO c1 := '**'
        IF n=iB DO c1,c2,c3 := '>','>','**'
        IF n=oB DO c3 := '**'
        IF Flo<n<Fhi DO c1 := aF
        IF Blo<n<Bhi DO c3 := aB
      }
  writef("%c%c%c", c1,c2,c3)
  RETURN
}

```

This tests whether the forward wire can be placed on the left and drawn without the two wires crossing. If so, the vertical portion of the forward wire is placed in *c1*, and *c3* is used by the backward wire. Again, there are special cases if any signal enters or leaves at this line position.

```

IF oB<iF<oF & iB<oF |
  oF<iB & oF<iF<oB DO
{ TEST sp
  THEN { // This is a spacer line
        // so only contains vertical wires
        IF Flo<n<=Fhi DO c3 := aF
        IF Blo<n<=Bhi DO c1 := aB
      }
  ELSE { // This is a non spacer line
        IF n=oF DO c1,c2,c3 := '<','<','**'
        IF n=iF DO c3 := '**'
        IF n=oB DO c1,c2,c3 := '**','>','>'
        IF n=iB DO c1 := '**'
        IF Flo<n<Fhi DO c3 := aF
        IF Blo<n<Bhi DO c1 := aB
      }
  writef("%c%c%c", c1,c2,c3)
  RETURN
}

```

This case is the mirror image of the previous one and routes the forward wire on the right hand side in *c3*.

We now know there are two wires that cannot be drawn without crossing.

```

IF iF=oF DO
{ c2 := aB
  TEST sp
  THEN { IF n=BlO DO c2 := '-'
        }
  ELSE { IF n=iF DO c1,c3 := '<','<'
        IF n=iB DO c1,c2 := '>','**'
        IF n=oB DO c2,c3 := '**','>'
        }
  writef("%c%c%c", c1,c2,c3)
  RETURN
}

```

This code tests whether the backward wire can use the centre column with the forward wire passing straight through it.

```

IF iB=oB DO
{ // The F wire can use the centre column.
  c2 := aF
  TEST sp
  THEN { IF n=FlO DO c2 := '-'
        }
  ELSE { IF n=iB DO c1,c3 := '>','>'
        IF n=oF DO c1,c2 := '<','**'
        IF n=iF DO c2,c3 := '**','<'
        }
  writef("%c%c%c", c1,c2,c3)
  RETURN
}

```

This is the mirror image of the previous situation. It places the forward wire in the centre c2 and lets the backward wire pass straight through it.

```

// Test whether the F and B signals enter at the
// same level, and leave at the same level.
// Note that iF cannot equal oB,
//      and iB cannot equal oF.
IF iF=iB &
  oF=oB TEST Fhi-FlO<=2
THEN { // No room for a cross over
      TEST sp
      THEN { IF n>iF | n>oF DO c2 := '|',

```

```

    }
    ELSE { IF Flo<n<Fhi DO c2 := '|'
          IF n=iF DO c1,c2,c3 := '>','**','<'
          IF n=oF DO c1,c2,c3 := '<','**','>'
    }
    writef("%c%c%c", c1,c2,c3)
    RETURN
}
ELSE { // The gap between iF and oF is more than 1 line
      // so the F wire can use the centre column and
      // the B wire can cross it half way down.
      LET m = (iF+oF)/2
      // Place the F wire down the centre.
      c2 := aF
      IF n=iF DO c2,c3 := '**','<'
      IF n=oF DO c1,c2 := '<','**'
      // Now place the B wire, crossing half way down.
      TEST iB>oB
      THEN { IF n>=m DO c1 := aB
            IF n<=m DO c3 := aB
            }
      ELSE { IF n>=m DO c3 := aB
            IF n<=m DO c1 := aB
            }
      UNLESS sp DO
      { IF n=iB DO c1 := '**'
        IF n=oB DO c3 := '**'
        IF n=m DO c1,c2,c3 := '**','>','**'
      }
      writef("%c%c%c", c1,c2,c3)
      RETURN
}
}

```

This code deal with the special case of both signal entering on the same line and leaving on the same line. Somehow they must be made to cross but there may not be room. If this happens we resort to patterns such as the following.

```

>*<          or          >*<
<*>          |
              <*>

```

But if there is room, we can place one wire along the centre c2 and let the other wire pass cross half way down.

```

IF Flo<iB<Fhi |
  Blo<iF<Bhi DO
{ // The F wire can be on the left.
  IF Flo<n<=Fhi DO c1 := aF
  IF Blo<n<=Bhi DO c3 := aB

  UNLESS sp DO
  { IF n=iF DO c1,c2,c3 := '**','<','<'
    IF n=iB DO c2,c3 := '>','**'
    IF n=oF DO c1 := '**'
    IF n=oB DO c3 := '**'
  }
  writef("%c%c%c", c1,c2,c3)
  RETURN
}

```

This case can be solved by placing the forward wire on the left and the backward wire on the right. The crossing takes place when one of the signals enters or leaves.

```

IF Flo<oB<Fhi |
  Blo<oF<Bhi DO
{ IF Flo<n<=Fhi DO c3 := aF
  IF Blo<n<=Bhi DO c1 := aB

  UNLESS sp DO
  { IF n=iF DO c3 := '**'
    IF n=iB DO c1 := '**'
    IF n=oF DO c1,c2,c3 := '<','<','**'
    IF n=oB DO c1,c2 := '**','>'
  }
  writef("%c%c%c", c1,c2,c3)
  RETURN
}

```

This case is the mirror image of the previous one. This time the forward wire is on the right.

We have now covered all possible situations, but if we are wrong, we write three question marks to indicate the fault.

```

// There should be no other possibilities
writef("???" )
}

```

4.19 Breaking the Enigma Code

The Enigma machine was beautifully engineered, reliable and easy to maintain. It had an incredibly large number of possible settings most generating completely different encryptions.

There were two reflectors to choose from and $5 \times 4 \times 3 = 60$ possible selections of three rotors from the five available. There were $26 \times 26 \times 26 = 17576$ possible initial rotor core positions. The $26 \times 26 = 676$ ring settings of the middle and right hand rotors affected the encryption, but since the middle rotor typically only steps once every 26 characters and the left hand rotor almost never steps, the difficulty of finding a compatible ring setting is considerably reduced.

The main complication is finding the plugboard's setting. There were ten cables each causing two letters to swap. There were thus six letters that pass straight through the plugboard unchanged. We first calculate how many ways we can select six letters from an alphabet of 26 letters. Mathematicians have no difficulty with this and instantly give the answer $\frac{26!}{6! \times 20!}$ which is known as a binomial coefficient, often written as C_6^{26} . This turns out to be the coefficient of x^6 in the expansion of $(1 + x)^{26}$. If we have no knowledge of binomials, we can derive this formula from first principles as follows. Consider all the permutations of 26 letters. For any particular permutation, the first letter will be any one of the 26 letters, the second will be any one of the remaining 25, the third will be one of 24, and so on. This tells us that the number of permutations of 26 letters is $26 \times 25 \times 24 \times \dots \times 1$ which is known as 26 factorial and is normally written as $26!$. If we now look at the first six letters these permutations, we will find it contains all possible selections of six letters from the alphabet but repeated many times over. We should divide by $6!$, the number of permutations of six letters, and by $20!$ the number of permutations of the remaining 20 letters that were not selected. This gives the answer $\frac{26!}{6! \times 20!}$ which can be written as $\frac{26 \times 25 \times 24 \times 23 \times 22 \times 21}{6 \times 5 \times 4 \times 3 \times 2 \times 1}$. This can be simplified by observing $22/2 = 11$, $21/3 = 7$, $24/(6 \times 4) = 1$ and $25/5 = 5$. So the result is $25 \times 5 \times 23 \times 11 \times 7 = 230230$, which is the number of ways of choosing the six letters that pass straight through the plugboard. The remaining 20 letters are paired up by the ten cables. First sort the 20 letters in alphabetical order, then select the left most letter and pair it with any one of the remaining 19 letters. Then select the leftmost letter that has not yet been paired and pair it with one of the remaining 17 letters. The next pairings have choices of 15, 13, etc. The total number of ways the pairing that can be done is thus $19 \times 17 \times 15 \times 13 \times 11 \times 9 \times 7 \times 5 \times 3 \times 1 = 654729075$, and so the total number of way the plugboard can be set is thus $230230 \times 654729075 = 150739274937250$ which is slightly more than 150 million million. If we multiply this by the number of ways the rotors can be set up we get a staggeringly large number in the region of 10^{23} . This large number provided convincing evidence the enigma code was unbreakable, and the Germans relied on this belief throughout the war.

However, Alan Turing and others at Bletchley Park discovered a weak-

ness in the code and designed a largely mechanical machine called the bombe to help decode Enigma messages. This section outlines a program (`bcplprogs/raspi/bombe.b`) that uses some of the principles used in the bombe. There is not space here to describe the program in detail. This section just gives an outline some of the principles used.

The method relies on having a crib consisting of some plain text and its encryption. Such cribs are obtained by guessing some likely plain text and matching it with all encrypted messages transmitted on that day. If the plain text is long enough most alignments of the plain text with encrypted text will be thrown out by the rule that no letter encrypts to itself. In the program, a crib is used consisting of the the first 29 letters of the message given in the previous section and its encryption. This choice has the advantage we know the answer and its long length means a solution can be found reasonably quickly. The decryption breakthrough came as a result of discovering a way of deducing the plugboard setting from the crib.

The program uses the first 29 letters of the message and its encryption shown below.

```

1      6      11     16     21     26     31     36     41
QBLTW LDAHH YEOEF PTWYB LENDP MKOXL DFAMU DWIJD XRJZ
DERFU EHRER ISTTO DXDER KAMPF GEHTW EITER XDOEN ITZX

```

It first converts the crib into what mathematicians like to call a graph consisting of 26 letter nodes joined by edges labelled with integers. The numbers are positions within the crib. For instance there is an edge labelled 1 joining node Q to node D, corresponding to the first position in the crib. As a debugging aid, the program outputs the graph as shown below. Notice that the line starting Q: has an edge 1D and that the line starting D: has and edge 1Q.

```

A: E 27  22E  8R
B: E 27  20R  2E
C: C  0
D: E 27  24P 18W 16P  7H  1Q
E: E 27  27K 22A 19Y 14T 12S  9H  6L  2B
F: E 27  25P 15O  4T
G: M  2  26M
H: E 27  28O 10R  9E  7D
I: E 27  11Y
J: J  0
K: E 27  27E 21L
L: E 27  21K  6E  3R
M: M  2  26G 23N
N: M  2  23M
O: E 27  28H 15F 13T

```

P: E 27 25F 24D 16D
 Q: E 27 1D
 R: E 27 20B 10H 8A 3L
 S: E 27 12E
 T: E 27 29X 17X 14E 13O 4F
 U: E 27 5W
 V: V 0
 W: E 27 18D 5U
 X: E 27 29T 17T
 Y: E 27 19E 11I
 Z: Z 0

This graph is easier to understand when printed as a diagram as follows.

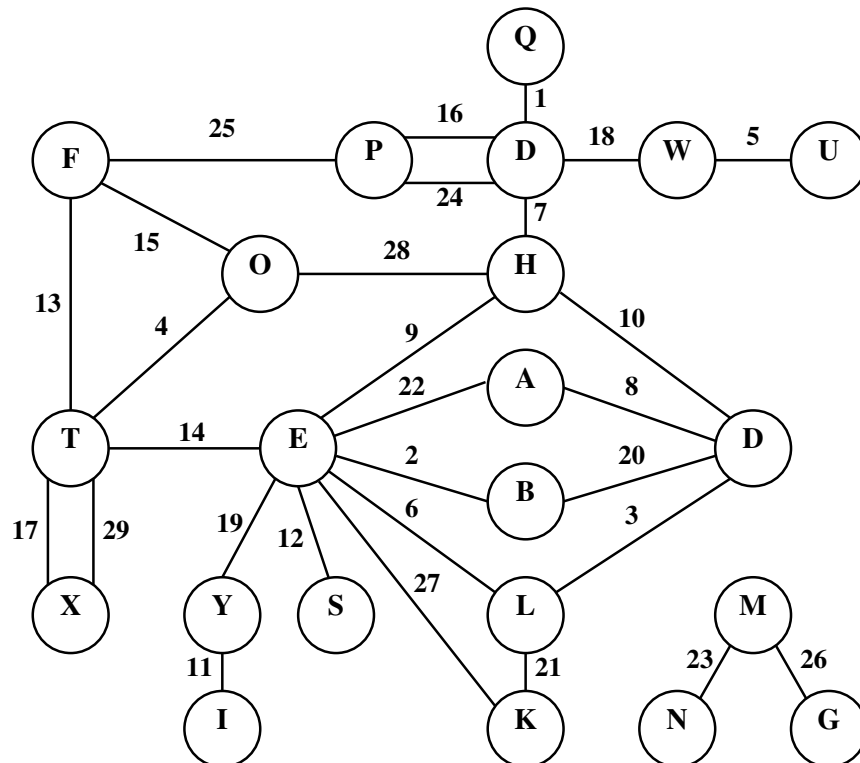

This graph allows us to generate a series of tests to see if a particular initial setting of the Enigma machine is consistent with the crib. The beauty of this mechanism is that we do not have to guess the wiring of the plugboard since it can be deduced as the tests are performed. We do, however, have to guess which reflector is used, which rotors have been selected for the left, middle and right hand positions. We also have to guess the rotational positions of the rotors and the notch positions of the middle and right hand rotors. Once these have been chosen, we can deduce the rotational position of each rotor for each position of the crib.

If the `bombe` program is called with the `-t` option, it generates the following trace output, and stops with an `ABORT 1000`, allowing the user to resume execution of the program using the `c` debugging command. A summary of other debugging commands can be seen by typing a question mark (?).

```
Testing reflector B rotors I   II  V   notches QEZ
```

```
Trying posL=A
```

```
turnpattern=1 nr=0
```

```
 1: ABB  lgqpzxboywuarthdcmvnksjfie
 2: ABC  lqxkuyjvngdasitrpbmoehzcfw
 3: ABD  pfvedbzjnhlkwiyastqrxcmuog
 4: ABE  zorkxvipgwdmlsbhucnyqfjeta
 5: ABF  mxxediyofpzwawhjbturnslncgk
 6: ABG  zhdcrykbqngwxjutievposlmfa
 7: ABH  smhfjdqcrewxbtvzgianyoklup
 8: ABI  wqhzfetclvmikyxubsrgpjaond
 9: ABJ  zgluribjfhvcwpsnteoqdkmyxa
10: ABK  luspoimvfzqagtedkycnbhxwrj
11: ABL  hwmuipsaeonzckjfxtrdybqvl
12: ABM  lmryoqhgwptabvejfcsknizdx
13: ABN  volwpxrkjihczqbengyutadfsm
14: ABO  hkewcjoapfbzrugivmyxnqdtsl
15: ABP  rleucytkmohbixjvzawgdpsnfq
16: ABQ  gmdcwialfzthbpyrxsrkvueqoj
17: ABR  dwtamzpyvkjnelrgxoucsibqhf
18: ABS  jifwqcvobamxkuhtesrpngdlzy
19: ABT  cnakiuylewdhsbrvzomxfpjtqg
20: ABU  siwznpymboqrhejfkaxvuctgd
21: ABV  ieyobpqjahusxvdfgwlzknrmct
22: ABW  duragqewsmvxjonyfcizbkhlp
23: ABX  guewczaroxmskpinvhlybqjtf
24: ABY  gtjwlkaoxcfeyrhusnqbpzdimv
25: ABZ  xlstrhnfykjbogmqpecdwzuaiv
26: ABA  uwkloxrsnzcdyieqpgvatbfmj
27: ACB  rlhkxocnsebqigumajypwvftd
28: ACC  hmunxzjaygopbdklsvqwrteif
29: ACD  jkmoqlipgabfcydhevzwxrtuns
```

```
Guess D -- trying inner=a
```

```
!! ABORT 1000: Unknown fault
```

```
*
```

This shows that the program has selected reflector B and rotors I, II and V. The setting of `turnpattern=1` causes the notch position of the middle rotor to

be such that the left hand rotor remains in the same rotation position for all 29 letters of the crib. The variable `nr` which is in the range 0 to 25 specified the initial position of the right hand rotor's notch. Since `nr` is set to 0, as the initial letter of the crib is pressed the right hand and middle rotors both advance to position B. So at message position 1, the rotors have stepped to **ABB**. Notice that the rotors step from **ABA** to **ACB** between message position 26 and 27, as expected, and notice also that the left hand rotor remains at position **A** throughout the crib.

The sequence of letters `lgqpzxboywuarthdcmvnksjfie` associated with rotor positions **ABB** shows that a signal entering the right hand rotor at position **a** will return to position **l** after passing through the rotors to the reflector and back to the right hand rotor. Similarly **b** maps to **g**, and **c** maps to **q**. These mappings are sometimes written as `a1l`, `b1g`, `c1q`, etc.

By convention, lower case letters, called inner letters, are used for positions of signals between the plugboard and the right hand rotor. Upper case letters, called outer letters, represent positions on the keyboard or lamp side of the plugboard. Thus `Q1D` shows the mapping of key **Q** to lamp **D** when the rotors are in position **1**.

If we look carefully at the graph, we see that, at position 16, pressing **D** generates **P**, and at position 24 pressing **P** generates **D**. The beauty of this observation is that we can try all the 26 possible inner letters that the plugboard might map outer letter **D** into. Most, if not all, of these will instantly lead to inconsistencies. Suppose we try mapping **D** to **b** using the program's choice of initial settings. At message position 16 we have `b16m`, and so, if our assumptions are correct, plugboard **m** must map to outer letter **P**. If we now consider the edge `P24D`, the inner letter for **P** is already known to be **m**, and at position 24 there is the mapping `m24y` implying that the inner letter for **D** should be **y**. But it has already been assigned inner letter **b**. So either mapping **D** to **b** is wrong or the initial settings are wrong. In either case we must backtrack.

The sequence of tests the program does can be represented by the following list of statements.

```
guess D
edge D 16 P
edge P 24 D
edge D 7 H
edge H 9 E
edge E 14 T
edge T 4 F
edge F 25 P
edge T 13 0
edge 0 15 F
edge H 28 0
edge T 17 X
edge T 29 X
```

```

edge H 10 R
edge E  2 B
edge R 20 B
edge R  3 L
edge E  6 L
edge R  8 A
edge A 22 E
edge L 21 K
edge E 27 K
edge D 18 W
edge E 19 Y
edge D  1 Q
edge W  5 U
edge Y 11 I
edge E 12 S
guess M
edge M 23 N
edge M 26 G
fin

```

The `guess` statements tries all possible plugboard mappings for its given outer letter, and the `edge` statements tests edges and the `fin` statement indicates that all edges have been tested.

We can see the effect of these statements by running the `bombe` with the `-t` option and stepping through the execution by typing `c` after each `ABORT 1000`. The effect of the first two choices `guess` makes is shown as follows (by typing `c` twice).

```

Guess D -- trying inner=a

!! ABORT 1000: Unknown fault
* c
  Guess setting pluboard D to a
  Guess setting pluboard A to d
edge D 16 P
  a16g
  Plugboard P and G are both unset, so
  Edge setting plugboard P to g
  Edge setting plugboard G to p
edge P 24 D
  g24a
  Plugboard D is already a, which is OK
edge D 7 H
  a7s
  Plugboard H and S are both unset, so

```

```

    Edge setting plugboard H to s
    Edge setting plugboard S to h
edge H 9 E
    s9o
    Plugboard E and O are both unset, so
    Edge setting plugboard E to o
    Edge setting plugboard O to e
edge E 14 T
    o14g
    Plugboard G is already set to p, so cannot set G to t -- Backtrack
    Edge unsetting plugboard E
    Edge unsetting plugboard O
    Edge unsetting plugboard H
    Edge unsetting plugboard S
    Edge unsetting plugboard P
    Edge unsetting plugboard G
    Guess unsetting plugboards D
    Guess unsetting plugboard A

Guess D -- trying inner=b

!! ABORT 1000: Unknown fault
* c
    Guess setting pluboard D to b
    Guess setting pluboard B to d
edge D 16 P
    b16m
    Plugboard P and M are both unset, so
    Edge setting plugboard P to m
    Edge setting plugboard M to p
edge P 24 D
    m24y
    Plugboard D is already set to b, so cannot be set D to y -- Backtrack
    Edge unsetting plugboard P
    Edge unsetting plugboard M
    Guess unsetting plugboards D
    Guess unsetting plugboard B

Guess D -- trying inner=c

!! ABORT 1000: Unknown fault
*
```

The sequence of statements is compiled by the function `trans` which first constructs the graph using structures to represent letter nodes and edges.

A letter node is represented by a small vector whose fields are accessed by the selectors: `n_parent`, `n_letter`, `n_list`, `n_len`, `n_size`, `n_visited` and `n_compiled`. The `parent` field is either zero or points to another letter node. It provides a cunning mechanism to determine whether there is a path of edges connecting two nodes. If there is such a path the two nodes are said to be in the same connected component. The mechanism will be described later. The `letter` field holds a number in the range 0 to 25 specifying the outer letter this node represents. The `list` field holds the list of edges belonging to this node, and the `len` field holds the length of this list. If the `parent` field is zero, the node is called a root, and the `size` field holds the total number of edges reachable from this root node. This is a measure of the complexity of the connected component this root node belongs to. The fields `visited` and `compiled` are used by the program that translates the graph into interpretive code. The field `compiled` is set to `TRUE` for all nodes in a connected component when all its the edges have been compiled.

An edge is represented by a vector whose fields are accessed by the selectors: `e_next`, `e_pos` and `e_dest`. The `next` field points to the next edge node in the list. The `pos` field holds the position in the crib corresponding to this edge and the `dest` field points to the destination node of this edge.

The vector `nodetab` whose subscripts range from 0 to 25 representing the letter `A` to `Z` has elements that point to the 26 letter nodes. Initially all the fields of each node are set to zero, except for its `letter` field which is set appropriately.

Edges are now added to the graph one at a time, the first being from `S` to `D` at position 1. This involves adding appropriate edge nodes to the lists belonging to the nodes for `S` and `D`. The `len` fields are incremented. The `parent` of any node provides a path to the root node of the connected component that the node belongs to. The root nodes for `S` and `D` are currently different so this edge joins the two previously disconnected components. This is implemented by choosing one of them to become the root of the combined component and setting the `parent` field of the other to point this new root. The sizes of the two components are summed and placed in the new root, and its value incremented because a new edge has just been added. When finding the root, it is often a good strategy to update all the `parent` links in the path to the root by direct links to the root since this typically makes later searches more efficient. Additionally, when combining two components, a good strategy is to make the root of the larger component the root of the combined component. These optimisations are important in applications involving millions of nodes. But in this program, they are not needed, and have only been done for educational reasons.

Once the graph has been constructed, the program compiles it into a sequence of the interpretive instructions. The interpretive code as shown above has intructions with only three function codes: `c_guess`, `c_edge` and `c_fin`.

The function code `guess` takes an outer letter argument and invites the interpreter to try all 26 possible plugboard mappings for this letter.

The function code `edge` takes three arguments representing the source letter, the message position of the edge, and the destination letter. The source letter refers to a node that has already been visited and so already has an inner letter assigned. The destination node may or may not have an inner letter assigned. If it has, it is checked for consistency, usually causing the program to backtrack. If the destination has no inner letter assigned, it is given the required letter and the plugboard is updated appropriately. Note that if, for instance, `W` is to be mapped to `g`, then `G` must also be mapped to `w`. This second mapping may be found to be inconsistent again causing the program to backtrack, but if not, the unvisited node for `G` will be given inner letter `w` increasing the chance of finding an inconsistency later.

The function code `fin` indicates that all edges of the graph have been checked and no inconsistencies have been found, so the current initial setting may be correct and should be checked. This function code outputs the current initial setting then backtracks so that other possible solutions can be found.

The translation into interpretive code is done with care to attempt to increase the efficiency of the tests. The graph is searched for a good starting node and, once chosen, it generates an appropriate `guess` instruction. The starting node will belong to a connected component of largest size, and will, if possible, be in a loop of length two. If no such loop exists, a node with the largest number of edges will be chosen. The edges of the connected component are then explored generating an `edge` instruction each time. As the compilation proceeds, nodes that have been visited and edges that have been used are marked as such.

The strategy used to select the next edge to compile is as follows. First choose an unused edge connecting two visited nodes. If no such edge is found, choose an unused edge from a visited node to a node that has a different edge back to a visited node. If no such edge exists, choose an edge from a visited node to a node having the largest number of edges. When all the edges of the component have been compiled, the `compiled` field of every node in the connected component is set to `TRUE`, causing them to play no further part in the compilation. If there are any unused edges left, the whole process is repeated, ignoring all nodes marked as compiled. The `fin` instruction is compiled when all edges have been compiled. Notice that nodes that have no edges correspond to letters that do not occur in the plain or encrypted text of the crib. After compiling the graph the resulting interpretive code is output.

The final part of the program successively selects the reflector, the three rotors, their initial core positions, the message position (0 to 25) of the first step of the middle rotor and a code (1 to 5) specifying if and when the left hand rotor steps and if and when the middle rotor does a double step. Having given this specification of the machine setting the interpretive code is executed to see if the setting is compatible with the crib. It will almost always find an incompatibility quickly and backtracks to test the next setting.

The `bombe` program can be compiled into native machine code and run by

typing:

```
cd ../../natbcpl
make -f MakefileRaspiSDL clean
make -f MakefileRaspiSDL bombe
./bombe
```

I ran it on my Pentium based laptop (replacing `MakefileRaspiSDL` by `MakefileSDL`) and found it took 3 minutes 28 seconds to find the solution, trying all possible rotor selections but only using reflector B. On a 256Mb Raspberry Pi, it takes about 29 minutes. This slow speed is probably because my program uses much more memory than it really needs.

4.20 The Advanced Encryption Standard

Having just studied how the Enigma machine was used to encrypt messages, it is perhaps appropriate to see how encryption is done on modern computers. The Advanced Encryption Standard (AES) supercedes the previous Data Encryption Standard (DES) that was published in 1977. DES used a key length of 56 bits which is now thought insufficiently secure considering the enormous power of modern computers. AES is now a well established replacement. It was announced by the U.S. National Institute of Standards and Technology (NIST) in 2001 after a five year standardisation process in which many rival systems were compared. The clear winner was a scheme developed by two Belgian cryptographers, Joan Daimen and Vincent Rijmen. It is normally called AES128, AES192 or AES256 depending on the key length being used. The scheme is elegant and cunning allowing encryption to be done efficiently on simple hardware such as smart cards as well as normal computers, and it is well worth studying.

This section presents a demonstration implementation (`aes128.b`) of the version using 128 bit keys. The program starts as follows.

```
GET "libhdr"

GLOBAL {
  Rkey:ug
  sbox
  rsbox
  mul
  tracing
  MixColumns_ts
  InvMixColumns_st
  Cipher
  InvCipher
```

```

prstate
prbytes
prmat

// The s state matrix
s00; s01; s02; s03
s10; s11; s12; s13
s20; s21; s22; s23
s30; s31; s32; s33

// The t state matrix
t00; t01; t02; t03
t10; t11; t12; t13
t20; t21; t22; t23
t30; t31; t32; t33

stateS
stateT
}

MANIFEST {
  Keylen=16 // 16 = 4x4
  Nr=10 // Number of rounds
}

```

The algorithm performs a sequence of transformations of a 4 by 4 matrix of 8-bit bytes. This matrix is called the state and, for convenience, is held either in the variables `s00` to `s33` or `t00` to `t33`. The key is 128 bits long represented by a vector of `Keylen` (=16) bytes. This key is expanded by the function `KeyExpand`, described below, to form a schedule of 11 keys in `Rkey` used during the encryption process. The data to be encrypted is broken into 128-bit chunks, placed in turn in the 16 bytes of the state matrix where the encryption process takes place. This consists of a sequence of ten repeated rounds of simple matrix transformations. All these transformations are reversible, so performing the inverse versions in reverse order can be used to decrypt the encrypted message.

One such matrix transformation is performed by the function `ShiftRows_st` defined below.

```

// The ShiftRows() function shifts the rows in the state to the left.
// Each row is shifted with different offset.
// Offset = Row number. So the first row is not shifted.
LET ShiftRows_st() BE
{ t00, t01, t02, t03 := s00, s01, s02, s03
  t10, t11, t12, t13 := s11, s12, s13, s10
  t20, t21, t22, t23 := s22, s23, s20, s21

```

```

    t30, t31, t32, t33 := s33, s30, s31, s32
}

```

```

LET InvShiftRows_ts() BE
{ s00, s01, s02, s03 := t00, t01, t02, t03
  s10, s11, s12, s13 := t13, t10, t11, t12
  s20, s21, s22, s23 := t22, t23, t20, t21
  s30, s31, s32, s33 := t31, t32, t33, t30
}

```

Another matrix transformation is performed by the function `SubBytes_ts`, defined as follows.

```

LET SubBytes_ts() BE
{ // Apply sbox from t state to s state
  FOR i = 0 TO 15 DO stateS!i := sbox%(stateT!i)
}

```

This uses the byte vector `sbox`, which specifies a permutation of the numbers 0 to 255, to convert bytes in state `t` to bytes in state `s`. Since a permutation is being used, the effect of `SubBytes_ts` can be reversed by the function `InvSubBytes_st`, defined as follows.

```

LET InvSubBytes_st() BE
{ // Apply rsbox from s state to t state
  FOR i = 0 TO 15 DO stateT!i := rsbox%(stateS!i)
}

```

This uses the byte vector `rsbox` representing the inverse of `sbox`. That is `rsbox%(sbox%x)=x` for all `x` in the range 0 to 255. These permutation vectors are defined by the function `inittables` as follows.

```

LET inittables() BE
{ sbox := TABLE
  #x7B777C63, #xC56F6BF2, #x2B670130, #x76ABD7FE,
  #x7DC982CA, #xF04759FA, #xAFA2D4AD, #xC072A49C,
  #x2693FDB7, #xCCF73F36, #xF1E5A534, #x1531D871,
  #xC323C704, #x9A059618, #xE2801207, #x75B227EB,
  #x1A2C8309, #xA05A6E1B, #xB3D63B52, #x842FE329,
  #xED00D153, #x5BB1FC20, #x39BECB6A, #xCF584C4A,
  #xFBAAEFD0, #x85334D43, #x7F02F945, #xA89F3C50,
  #x8F40A351, #xF5389D92, #x21DAB6BC, #xD2F3FF10,
  #xEC130CCD, #x1744975F, #x3D7EA7C4, #x73195D64,
  #xDC4F8160, #x88902A22, #x14B8EE46, #xDB0B5EDE,

```



```

    #x0A3A32E0, #x5C240649, #x62ACD3C2, #x79E49591,
    #x6D37C8E7, #xA94ED58D, #xEAF4566C, #x08AE7A65,
    #x2E2578BA, #xC6B4A61C, #x1F74DDE8, #x8A8BBD4B,
    #x66B53E70, #x0EF60348, #xB9573561, #x9E1DC186,
    #x1198F8E1, #x948ED969, #xE9871E9B, #xDF2855CE,
    #x0D89A18C, #x6842E6BF, #x0F2D9941, #x16BB54B0

rsbox := TABLE
    #xD56A0952, #x38A53630, #x9EA340BF, #xFBD7F381,
    #x8239E37C, #x87FF2F9B, #x44438E34, #xCBE9DEC4,
    #x32947B54, #x3D23C2A6, #x0B954CEE, #x4EC3FA42,
    #x66A12E08, #xB224D928, #x49A25B76, #x25D18B6D,
    #x64F6F872, #x16986886, #xCC5CA4D4, #x92B6655D,
    #x5048706C, #xDAB9EDFD, #x5746155E, #x849D8DA7,
    #x00ABD890, #x0AD3BC8C, #x0558E4F7, #x0645B3B8,
    #x8F1E2CD0, #x020F3FCA, #x03BDAFC1, #x6B8A1301,
    #x4111913A, #xEADC674F, #xCECFF297, #x73E6B4F0,
    #x2274AC96, #x8535ADE7, #xE837F9E2, #x6EDF751C,
    #x711AF147, #x89C5291D, #x0E62B76F, #x1BBE18AA,
    #x4B3E56FC, #x2079D2C6, #xFEC0DB9A, #xF45ACD78,
    #x33A8DD1F, #x31C70788, #x591012B1, #x5FEC8027,
    #xA97F5160, #x0D4AB519, #x9F7AE52D, #xEF9CC993,
    #x4D3BE0A0, #xB0F52AAE, #x3CBBEBC8, #x61995383,
    #x7E042B17, #x26D677BA, #x631469E1, #x7D0C2155
}

```

These TABLEs assume that BCPL is running on a, so called, little ended 32 bit version of BCPL such as that used on the Raspberry Pi and Pentium based machines. Notice that, for instance, `sbox%0=#x63` and `sbox%1=#x7C`.

The next function `AddRoundKey_st` applies a specified round key from the schedule to the state matrix.

```

LET AddRoundKey_st(i) BE
{ // Add key round i from s state to t state
  LET K = @Rkey!(16*i) // n = number of elements per row
  FOR i = 0 TO 15 DO stateT!i := stateS!i XOR K!i
}

```

The vector `Rkey` holds a schedule of round keys numbered from 0 to 10. Each round key consists of 16 bytes occupying four words in `Rkey`. `K` is declared to point to round key `i`. `AddRoundKey(i)` XORs the bytes of round key `i` with the corresponding elements of state `s`, placing the result in state `t`.

It is convenient to have a version of `AddRoundKey` that transforms state `t` into state `s`. This is defined as follows.

```

LET AddRoundKey_ts(i) BE
{ // Add key round i from s state to t state
  LET K = @Rkey!(16*i) // n = number of elements per row
  FOR i = 0 TO 15 DO stateS!i := stateT!i XOR K!i
}

```

This function is also the inverse of `AddRoundKey_st`.

The `AddRoundKey` functions use round keys numbered 0 to 10, each being 16 words in length, holding one byte per word. This schedule of keys is derived from the given cipher key and is constructed by the function `KeyExpansion` defined as follows.

```

LET KeyExpansion(key) BE
{ LET rcon = 1

  // The first round key is the cipher key itself,
  // stored column by column.
  Rkey!00, Rkey!01, Rkey!02, Rkey!03 := key%00, key%04, key%08, key%12
  Rkey!04, Rkey!05, Rkey!06, Rkey!07 := key%01, key%05, key%09, key%13
  Rkey!08, Rkey!09, Rkey!10, Rkey!11 := key%02, key%06, key%10, key%14
  Rkey!12, Rkey!13, Rkey!14, Rkey!15 := key%03, key%07, key%11, key%15

  // Add 10 more keys to the round schedule
  FOR i = 1 TO 10 DO
  { LET p = @Rkey!(16*i) // Pointer to space for key in round i
    LET q = p-16 // Pointer to round key i-1

    p!00 := q!00 XOR sbox%(q!07) XOR rcon
    p!04 := q!04 XOR sbox%(q!11)
    p!08 := q!08 XOR sbox%(q!15)
    p!12 := q!12 XOR sbox%(q!03)

    FOR j = 1 TO 3 DO
    { p!(00+j) := q!(00+j) XOR p!(j-01)
      p!(04+j) := q!(04+j) XOR p!(j+03)
      p!(08+j) := q!(08+j) XOR p!(j+07)
      p!(12+j) := q!(12+j) XOR p!(j+11)
    }

    rcon := mul(2, rcon)
  }
}

```

Round key 0 is just the given 16 byte cipher key, packed one byte per word. Each subsequent round key is a simple modification of the previous round key.

Each of the first 4 bytes of the new round key are the corresponding bytes of the previous key modified by one of the last four bytes of the previous round key changed by an application of the `sbox`. In addition the first byte of the new round key is modified by `rcon` which holds the value 2^i where i is the new round key number. This value is calculated using the 8-bit arithmetic of $\text{GF}(2^8)$. That is why the next value of `rcon` is computed by the call `mul(2,rcon)` using `mul`, defined below. Words 4 to 15 of the new key is just the exclusive or earlier pairs of words in `Rkey`.

The next matrix function `MixColumns_ts` replaces each column of the state matrix `t` by a values that are linear combinations of the column elements, leaving the result in state `s`. For instance, it sets `s00` to $2 \times t00 + 3 \times t10 + t20 + t30$. All 16 elements of the state are modified, and the total transformation corresponds to the following matrix product.

$$\begin{pmatrix} 2 & 3 & 1 & 1 \\ 1 & 2 & 3 & 1 \\ 1 & 1 & 2 & 3 \\ 3 & 1 & 1 & 2 \end{pmatrix} \begin{pmatrix} t00 & t01 & t02 & t03 \\ t10 & t11 & t12 & t13 \\ t20 & t21 & t22 & t23 \\ t30 & t31 & t32 & t33 \end{pmatrix} \Rightarrow \begin{pmatrix} s00 & s01 & s02 & s03 \\ s10 & s11 & s12 & s13 \\ s20 & s21 & s22 & s23 \\ s30 & s31 & s32 & s33 \end{pmatrix}$$

When 4 by 4 matrices are multiplied together the rule is as follows.

$$\begin{pmatrix} \cdot & \cdot & \cdot & \cdot \\ \cdot & \cdot & \cdot & \cdot \\ a & b & c & d \\ \cdot & \cdot & \cdot & \cdot \end{pmatrix} \begin{pmatrix} \cdot & x & \cdot & \cdot \\ \cdot & y & \cdot & \cdot \\ \cdot & z & \cdot & \cdot \\ \cdot & w & \cdot & \cdot \end{pmatrix} \Rightarrow \begin{pmatrix} \cdot & \cdot & \cdot & \cdot \\ \cdot & \cdot & \cdot & \cdot \\ \cdot & r & \cdot & \cdot \\ \cdot & \cdot & \cdot & \cdot \end{pmatrix}$$

where $r = ax + by + cz + dw$, thus the value in the i^{th} row and j^{th} column of the result is the sum of the products of the elements of the i^{th} row of the left hand matrix with the corresponding elements of the j^{th} column of the right hand one.

Since the elements of the state matrix are all 8-bit bytes (held in words), ordinary addition and multiplication cannot be used since they will cause overflow. Instead, arithmetic belonging to the Galois¹ Field $\text{GF}(2^8)$ is used. This replaces `+` by `XOR` and $x \times y$ by `mul(x,y)`, where `mul` is defined as follows.

```
LET mul(x, y) = VALOF
{ // Return the product of x and y using GF(2**8) arithmetic
  LET res = 0
```

¹Named after the French mathematician Evariste Galois who died aged only 20 in Paris in May 1832 from wounds suffered in a duel. He laid the foundations for Galois theory and Group Theory

```

WHILE x DO
{ IF (x & 1)>0 DO res := res XOR y
  x := x>>1
  y := y<<1
  IF y > 255 DO y := y XOR #x11B
}
RESULTIS res
}

```

This performs the multiplication by conditionally adding y to the result res whenever the least significant bit of x is a one. Then dividing x by 2 with a right shift ($x:=x>>1$) and doubling y with a left shift ($y:=y<<1$), but whenever y becomes larger than 255, it is brought back into range by the assignment $y := y \text{ XOR } \#x11B$. The constant $\#x11B$ was carefully chosen so that, for any x in the range 1 to 255, we can find a unique y such that $\text{mul}(x,y)=1$. Addition and subtraction are replaced by applications of the XOR operator. We thus have, in $GF(2^8)$, versions of addition, subtraction, multiplication and division that obey the algebraic rules of ordinary arithmetic, but on values that are always in the range 0 to 255. You still have to be careful since, for instance $2 \times x \neq x + x$ and $3 \times x$ is $\text{mul}(3,x) = \text{mul}(2,x) \text{ XOR } x$, not $x + x + x$ which just equal x .

To implement the matrix multiplication, we frequently need to compute expressions of the form $ax + by + cz + dw$. This is often called the inner product of (a, b, c, d) and (x, y, z, w) , and so we have a function called `inprod` to do the job. Its definition is as follows.

```

AND inprod(a,b,c,d, x,y,z,w) =
  // Calculate ax+by+cz+dw using GF(2**8) arithmetic
  mul(a,x) XOR mul(b,y) XOR mul(c,z) XOR mul(d,w)

```

The implementation of `MixColumns_ts` is now straightforward and is as follows.

```

// MixColumns function mixes the columns of the state matrix
LET MixColumns_ts() BE
{ // Compute the matrix product
  // (2 3 1 1) ( t00 t01 t02 t03) (s00 s01 s02 s03)
  // (1 2 3 1) x ( t10 t11 t12 t13) => (s10 s11 s12 s13)
  // (1 1 2 3) ( t20 t21 t22 t23) (s20 s21 s22 s23)
  // (3 1 1 2) ( t30 t31 t32 t33) (s30 s31 s32 s33)

  s00 := inprod(2, 3, 1, 1, t00, t10, t20, t30)
  s01 := inprod(2, 3, 1, 1, t01, t11, t21, t31)
  s02 := inprod(2, 3, 1, 1, t02, t12, t22, t32)
  s03 := inprod(2, 3, 1, 1, t03, t13, t23, t33)
}

```

```

s10 := inprod(1, 2, 3, 1, t00, t10, t20, t30)
s11 := inprod(1, 2, 3, 1, t01, t11, t21, t31)
s12 := inprod(1, 2, 3, 1, t02, t12, t22, t32)
s13 := inprod(1, 2, 3, 1, t03, t13, t23, t33)

s20 := inprod(1, 1, 2, 3, t00, t10, t20, t30)
s21 := inprod(1, 1, 2, 3, t01, t11, t21, t31)
s22 := inprod(1, 1, 2, 3, t02, t12, t22, t32)
s23 := inprod(1, 1, 2, 3, t03, t13, t23, t33)

s30 := inprod(3, 1, 1, 2, t00, t10, t20, t30)
s31 := inprod(3, 1, 1, 2, t01, t11, t21, t31)
s32 := inprod(3, 1, 1, 2, t02, t12, t22, t32)
s33 := inprod(3, 1, 1, 2, t03, t13, t23, t33)
}

```

The choice of this transformation matrix is well chosen because multiplication by 1, 2 and 3 in $\text{GF}(2^8)$ can be done efficiently both in hardware and software, and it also has the vital property that it has an inverse in $\text{GF}(2^8)$ namely:

$$\begin{pmatrix} 14 & 11 & 13 & 9 \\ 9 & 14 & 11 & 13 \\ 13 & 9 & 14 & 11 \\ 11 & 13 & 9 & 14 \end{pmatrix}$$

We can easily see that this is indeed the inverse by checking the follow equation.

$$\begin{pmatrix} 14 & 11 & 13 & 9 \\ 9 & 14 & 11 & 13 \\ 13 & 9 & 14 & 11 \\ 11 & 13 & 9 & 14 \end{pmatrix} \begin{pmatrix} 2 & 3 & 1 & 1 \\ 1 & 2 & 3 & 1 \\ 1 & 1 & 2 & 3 \\ 3 & 1 & 1 & 2 \end{pmatrix} = \begin{pmatrix} 1 & 0 & 0 & 0 \\ 0 & 1 & 0 & 0 \\ 0 & 0 & 1 & 0 \\ 0 & 0 & 0 & 1 \end{pmatrix}$$

The value that should be in element (0,0) of the result is $14 \times 2 + 11 \times 1 + 13 \times 1 + 9 \times 3$ using $\text{GF}(2^8)$ arithmetic. Note that 9×3 is $10010 \text{ XOR } 1001 = 11011$ in binary. So the sum in binary is:

```

14x2  11100
11x1   1011
13x1   1101
9x3   11011      (= 10010 XOR 1001)
-----
00001

```

Similarly, the value that should be in element (0,1) of the result is:

```

14x3  10010      (= 11100 XOR 1110)
11x2  10110
13x1   1101
 9x1   1001
-----
      00000

```

The other 14 elements of the product can easily be checked.

To undo the effect of `MixColumns_ts` we simply multiply the state matrix by the inverse transform. This is done by `InvMixColumns_st` define as follows.

```

LET InvMixColumns_st() BE
{ // Compute the matrix product
  // (14 11 13 9) (s00 s01 s02 s03) (t00 t01 t02 t03)
  // ( 9 14 11 13) x (s10 s11 s12 s13) => (t10 t11 t12 t13)
  // (13 9 14 11) (s20 s21 s22 s23) (t20 t21 t22 t23)
  // (11 13 9 14) (s30 s31 s32 s33) (t30 t31 t32 t33)

  t00 := inprod(14, 11, 13, 9, s00, s10, s20, s30)
  t01 := inprod(14, 11, 13, 9, s01, s11, s21, s31)
  t02 := inprod(14, 11, 13, 9, s02, s12, s22, s32)
  t03 := inprod(14, 11, 13, 9, s03, s13, s23, s33)

  t10 := inprod( 9, 14, 11, 13, s00, s10, s20, s30)
  t11 := inprod( 9, 14, 11, 13, s01, s11, s21, s31)
  t12 := inprod( 9, 14, 11, 13, s02, s12, s22, s32)
  t13 := inprod( 9, 14, 11, 13, s03, s13, s23, s33)

  t20 := inprod(13, 9, 14, 11, s00, s10, s20, s30)
  t21 := inprod(13, 9, 14, 11, s01, s11, s21, s31)
  t22 := inprod(13, 9, 14, 11, s02, s12, s22, s32)
  t23 := inprod(13, 9, 14, 11, s03, s13, s23, s33)

  t30 := inprod(11, 13, 9, 14, s00, s10, s20, s30)
  t31 := inprod(11, 13, 9, 14, s01, s11, s21, s31)
  t32 := inprod(11, 13, 9, 14, s02, s12, s22, s32)
  t33 := inprod(11, 13, 9, 14, s03, s13, s23, s33)
}

```

The function `Cipher` defined below performs a long sequence of these matrix transformations. This is a demonstration version since it can output helpful tracing information and has not been optimised to run efficiently.

```

LET Cipher(in, out) BE
{ // Copy the input PlainText into the state array.
  s00, s01, s02, s03 := in%00, in%04, in%08, in%12
  s10, s11, s12, s13 := in%01, in%05, in%09, in%13
  s20, s21, s22, s23 := in%02, in%06, in%10, in%14
  s30, s31, s32, s33 := in%03, in%07, in%11, in%15

  IF tracing DO
  { writef("%i2.input  ", 0); prstate(stateS)
    writef("%i2.k_sch  ", 0); prstate(Rkey)
  }

  // Add the First round key to the state before starting the rounds.
  AddRoundKey_st(0)

  FOR round = 1 TO Nr-1 DO
  { IF tracing DO
    { writef("%i2.start  ", round); prstate(stateT) }

    SubBytes_ts()
    IF tracing DO
    { writef("%i2.s_box  ", round); prstate(stateS) }

    ShiftRows_st()
    IF tracing DO
    { writef("%i2.s_row  ", round); prstate(stateT) }

    MixColumns_ts()
    IF tracing DO
    { writef("%i2.s_col  ", round); prstate(stateS) }

    AddRoundKey_st(round)
    IF tracing DO
    { writef("%i2.k_sch  ", round); prstate(@Rkey!(16*round)) }
  }

  // The last round is given below.
  IF tracing DO
  { writef("%i2.start  ", Nr); prstate(stateT) }

  SubBytes_ts()
  IF tracing DO
  { writef("%i2.s_box  ", Nr); prstate(stateS) }

  ShiftRows_st()

```

```

IF tracing D0
{ writef("%i2.s_row  ", Nr); prstate(stateT) }

// Do not mix the columns in the final round

AddRoundKey_ts(Nr)
IF tracing D0
{ writef("%i2.k_sch  ", Nr); prstate(@Rkey!(16*Nr))
  writef("%i2.output ", Nr); prstate(stateS)
}

// The encryption process is over.
// Copy the state array to output array.
out%00, out%04, out%08, out%12 := s00, s01, s02, s03
out%01, out%05, out%09, out%13 := s10, s11, s12, s13
out%02, out%06, out%10, out%14 := s20, s21, s22, s23
out%03, out%07, out%11, out%15 := s30, s31, s32, s33
}

```

16 bytes of input data given in `in` are copied into the state matrix and then modified by the call `AddRoundkey(0)` before performing 10 rounds of matrix modification. Each round successively calls `SubBytes_ts`, `ShiftRows_st()`, `MixColumns_ts()`, and `AddRoundKey_st`, except in last round when `MixColumns_ts` is not called. As a debugging aid the state matrix is conditionally output after each call. After the tenth round is complete the data in the state matrix are copied the byte vector `out`.

To decypher a message the function `InvCipher`, defined below, is used. Its structure is similar to `Cipher` but performs the inverse matrix transformations in reverse order, using the same key schedule.

```

LET InvCipher(in, out) BE
{ // Copy the input CipherText to state array.
  s00, s01, s02, s03 := in%00, in%04, in%08, in%12
  s10, s11, s12, s13 := in%01, in%05, in%09, in%13
  s20, s21, s22, s23 := in%02, in%06, in%10, in%14
  s30, s31, s32, s33 := in%03, in%07, in%11, in%15

  IF tracing D0
  { writef("%i2.iinput ", 0); prstate(stateS)
    writef("%i2.ik_sch ", 0); prstate(@Rkey!(16*Nr))
  }

  // Add the Last round key to the state before starting the rounds.
  AddRoundKey_st(Nr)
}

```



```

FOR round = Nr-1 TO 1 BY -1 DO
{ IF tracing DO
  { writef("%i2.istart ", Nr-round); prstate(stateT) }

  InvShiftRows_ts()
  IF tracing DO
  { writef("%i2.is_row ", Nr-round); prstate(stateS) }

  InvSubBytes_st()
  IF tracing DO
  { writef("%i2.is_box ", Nr-round); prstate(stateT) }

  AddRoundKey_ts(round)
  IF tracing DO
  { writef("%i2.ik_sch ", Nr-round); prstate(@Rkey!(16*round))
    writef("%i2.is_add ", Nr-round); prstate(stateS)
  }

  InvMixColumns_st()
}

IF tracing DO
{ writef("%i2.istart ", Nr); prstate(stateT) }

// The final round is given below.
InvShiftRows_ts()
IF tracing DO { writef("%i2.is_row ", Nr); prstate(stateS) }

InvSubBytes_st()
IF tracing DO { writef("%i2.is_box ", Nr); prstate(stateT) }

// Do not mix the columns in the final round
AddRoundKey_ts(0)
IF tracing DO
{ writef("%i2.ik_sch ", Nr); prstate(@Rkey!(16*0))
  writef("%i2.ioutput", Nr); prstate(stateS)
}

// The decryption process is over.
// Copy the state array to output array.
out%00, out%04, out%08, out%12 := s00, s01, s02, s03
out%01, out%05, out%09, out%13 := s10, s11, s12, s13
out%02, out%06, out%10, out%14 := s20, s21, s22, s23
out%03, out%07, out%11, out%15 := s30, s31, s32, s33

```

```
}

```

The main program `start` exercises these two functions with 16 bytes of plain text and 16 bytes of cipher key. In this version `KeyExpansion`, `Cipher` and `InvCipher` are called using the library function `instrcount` which returns the number of Cintcode instructions executed during each call.

```
LET start() = VALOF
{ LET argv = VEC 50
  LET plain = TABLE #X33221100, #X77665544, #XBBAA9988, #XFFEEDDCC
  LET key    = TABLE #x03020100, #x07060504, #x0B0A0908, #x0F0E0D0C
  // The plain text and key are the same as given in the detailed
  // example in Appendix C.1 in
  // csrc.nist.gov/publications/fips/fips197/fips-197.pdf
  // It provides a useful check that this implementaion is correct.
  // Just execute: aes128 -t
  LET in  = VEC 63
  LET out = VEC 63
  LET v   = VEC 10*16+15 // For the key schedule of 11 keys
  LET countExpand, countCipher, countInvCipher = 0, 0, 0

  Rkey := v
  stateS, stateT := @s00, @t00

  UNLESS rdargs("-t/s", argv, 50) DO
  { writef("Bad arguments for aes128*n")
    RESULTIS 0
  }

  tracing := argv!0

  inittables()

  //KeyExpansion(key)
  countExpand := instrcount(KeyExpansion, key)

  IF tracing DO
  { writef("*nKey schedule*n")
    FOR i = 0 TO Nr DO
    { LET p = 16*i
      writef("%i2: ", i)
      prstate(@Rkey!p)
    }
  }
  newline()
}
```

```

writef("plain:          "); prbytes(plain); newline()
writef("key:            "); prbytes(key)
newline()

//Cipher(plain, out)
countCipher := instrcount(Cipher, plain, out)

newline()

writef("Cipher text:    "); prbytes(out); newline()

//InvCipher(out, in)
countInvCipher := instrcount(InvCipher, out, in)
IF tracing DO newline()

writef("InvCipher text: "); prbytes(in); newline()

newline()
writef("Cintcode instruction counts*n*n")
writef("KeyExpansion: %i7*n", countExpand)
writef("Cipher:          %i7*n", countCipher)
writef("InvCipher:       %i7*n", countInvCipher)

RESULTIS 0
}

```

The remaining functions, defined below, are used to provide the debugging output.

```

AND prstate(m) BE
{ // For outputting state matrix or keys, column by column.
  FOR i = 0 TO 3 DO
  { wrch(' ')
    FOR j = 0 TO 3 DO
      writef("%x2", m!(4*j+i))
    }
  }
  newline()
}

AND prbytes(v) BE
{ // For outputting plain and ciphered text.
  FOR i = 0 TO 15 DO
  { IF i MOD 4 = 0 DO wrch(' ')
    writef("%x2", v%i)
  }
}

```

```

    }
    newline()
}

```

When `aes128` is run without arguments the output is as follows.

```

0.050> aes128

plain:          00112233 44556677 8899AABB CCDDEEFF
key:            00010203 04050607 08090A0B 0C0D0E0F
Cipher text:    69C4E0D8 6A7B0430 D8CDB780 70B4C55A
InvCipher text: 00112233 44556677 8899AABB CCDDEEFF

Cintcode instruction counts

KeyExpansion:   2834
Cipher:         33588
InvCipher:      63581
0.010>

```

This shows that the given plain text is converted by `Cipher` to suitably random looking text using the given key and that `InvCipher` restores the original plain text correctly.

You will also notice that `InvCipher` executes nearly twice as many Cintcode instructions as `Cipher`. This somewhat surprising result is because much of the time is spent in `mul` while performing the matrix multiplications in `MixColumns` and `InvMixColumns`. In `MixColumns` `mul` is multiplying by 1, 2 or 3 which takes far fewer instructions than the calls of `mul` in `InvMixColumns` where the multiplications are by 9, 11, 13 or 14.

For completeness, I have included a demonstration version of AES using a 256 bit cipher key. This program is called `bcplprog/raspi/aes256.b`. It has much in common with `aes128.b` using, for instance, the same 4 by 4 state matrix and the same matrix transformations, but it performs 14 rounds rather than 10. The main difference is how the schedule of 16 byte keys are generated from the given 32 byte cipher key. The increased running time of `aes256` is small being mainly due to the increased number of rounds.

4.20.1 Final Observation

The security of encryption is based entirely on keeping keys secret and not on hiding the details of the encryption algorithm. After all AES is available on

thousands of million machines around the world and anyone with a superuser or administrator password would be able to see the algorithm.

I hope you agree that AES128 is incredibly simple and elegant, and remarkably efficient. It is natural to wonder whether it could be extended to allow even stronger encryption. One obvious possibility is to use a larger state matrix, perhaps of size 8×8 or even 16×16 . All the transformations are easily extended except possibly for the difficulty of finding suitable column mixing matrices and their inverses using $\text{GF}(2^8)$ arithmetic. But this turns out to be simple with the aid of the program `invert.b` which shows, for instance, that the following two 8×8 matrices are mutual inverses:

$$\begin{pmatrix} 73 & 129 & 196 & 102 & 231 & 219 & 65 & 198 \\ 198 & 73 & 129 & 196 & 102 & 231 & 219 & 65 \\ 65 & 198 & 73 & 129 & 196 & 102 & 231 & 219 \\ 219 & 65 & 198 & 73 & 129 & 196 & 102 & 231 \\ 231 & 219 & 65 & 198 & 73 & 129 & 196 & 102 \\ 102 & 231 & 219 & 65 & 198 & 73 & 129 & 196 \\ 196 & 102 & 231 & 219 & 65 & 198 & 73 & 129 \\ 129 & 196 & 102 & 231 & 219 & 65 & 198 & 73 \end{pmatrix} \times \begin{pmatrix} 2 & 3 & 4 & 5 & 6 & 1 & 1 & 1 \\ 1 & 2 & 3 & 4 & 5 & 6 & 1 & 1 \\ 1 & 1 & 2 & 3 & 4 & 5 & 6 & 1 \\ 1 & 1 & 1 & 2 & 3 & 4 & 5 & 6 \\ 6 & 1 & 1 & 1 & 2 & 3 & 4 & 5 \\ 5 & 6 & 1 & 1 & 1 & 2 & 3 & 4 \\ 4 & 5 & 6 & 1 & 1 & 1 & 2 & 3 \\ 3 & 4 & 5 & 6 & 1 & 1 & 1 & 2 \end{pmatrix} = \begin{pmatrix} 1 & 0 & 0 & 0 & 0 & 0 & 0 & 0 \\ 0 & 1 & 0 & 0 & 0 & 0 & 0 & 0 \\ 0 & 0 & 1 & 0 & 0 & 0 & 0 & 0 \\ 0 & 0 & 0 & 1 & 0 & 0 & 0 & 0 \\ 0 & 0 & 0 & 0 & 1 & 0 & 0 & 0 \\ 0 & 0 & 0 & 0 & 0 & 1 & 0 & 0 \\ 0 & 0 & 0 & 0 & 0 & 0 & 1 & 0 \\ 0 & 0 & 0 & 0 & 0 & 0 & 0 & 1 \end{pmatrix}$$

using $\text{GF}(2^8)$ arithmetic. The program will also find inverses of matrices of other sizes, such as 16×16 .

If we choose to use 8×8 matrices it would be natural to use a key length of 64 bytes (or 512 bits), and encrypt the data in blocks of 64 bytes. For 16×16 matrices, we would use keys of 256 bytes (or 2048 bits). As a demonstration, the program `aesnxn.b` implements these two possibilities. Using the `stats` option `aesnxn` will output some statistics on the encoding process. For instance, some of the output generated by the command: `aesnxn 8 stats` is as follows.

Histogram of the number of bits changed

```
0:  0  0  0  0  0  0  0  0  0  0  0  0  0  0  0  0
16: 0  0  0  0  0  0  0  0  0  0  0  0  0  0  0  0
```

```

...
224:  1  0  1  0  0  1  1  2  4  2  2  3  7  2  6  6
240:  8  4  7 11 12 12 13 19 16 13 14 12 13 21 21 21
256: 17 12 16 14 22 13 11 17 16 18 10 13 13  6 10  7
272:  7  9  3  6  3  2  3  2  1  2  1  1  1  0  0  1
...
496:  0  0  0  0  0  0  0  0  0  0  0  0  0  0  0  0

```

Histogram of the number of times each bit changes

```

  0: 251 275 239 261 257 268 224 247 267 258 266 257 246 252 259 255
 16: 251 257 260 268 273 267 264 245 270 252 231 255 244 262 274 262
 32: 256 255 261 245 252 251 258 252 265 254 257 259 264 256 246 266
...
464: 264 251 260 235 264 252 241 255 271 259 256 255 249 251 271 256
480: 265 247 238 267 256 251 250 256 257 265 259 236 266 247 259 254
496: 255 265 263 259 257 267 275 243 272 236 251 247 265 257 250 252
3.190>

```

This shows two histograms based on 512 runs of the ciphering process complementing a different bit of the plain text each time. The first histogram shows that roughly half the bits of the encyphered data change each time, and the second shows that every bit of the encyphered data is equally likely to change.

As a final remark, you may like to look at the following function.

```

AND increment(p, w) BE WHILE w DO
{ LET c = !p & w // The carry bits
  !p := !p XOR w
  w, p := c, p+1 // The next bit position is one word later.
}

```

This function is used to increment the counts needed by the second histogram. The argument `p` points to a word containing the least significant bit of 32 counters. The more significant bits are held in `p!1`, `p!2` and so on. The argument `w` is a bit pattern specifying which counters are to be incremented. The function is thus capable of incrementing any subset of 32 counters simultaneously.

The function `countvalue`, defined below, converts a selected counter to a normal integer. Note that the counters in this implementation are limited to 16 bits.

```

AND countvalue(p, bit) = VALOF
{ LET res = 0
  FOR j = 15 TO 0 BY -1 DO
  { res := 2*res

```

```

    UNLESS (p!j & bit) = 0 DO res := res+1
  }
  RESULTIS res
}

```

4.21 $GF(2^8)$ Arithmetic

We have seen that $GF(2^8)$ arithmetic was used in the implementation of the advanced encryption standard, but it turns out this form of arithmetic is used in many other algorithms, so it is worth a little more explanation. $GF(2^8)$ is an example of a mathematical field and such a field consists of a set of elements and two operators normally written as $+$ for addition and \times for multiplication, satisfying the following algebraic rules.

- (1) If x and y are elements of the set then so are $x + y$ and $x \times y$.
- (2) If x , y and z are elements of the set then $x + (y + z) = (x + y) + z$ and $x \times (y \times z) = (x \times y) \times z$.
- (3) If x and y are elements of the set then $x + y = y + x$ and $x \times y = y \times x$.
- (4) There exists an element 0 such that $x + 0 = x$ for all x in the set.
- (5) There exists an element 1 different from 0 such that $x \times 1 = x$ for all x in the set.
- (6) For every element x in the set, there exist an element y such that $x + y = 0$.
- (7) For every element x in the set other than 0, there exist an element y such that $x \times y = 1$.
- (8) If x , y and z are elements of the set then $x \times (y + z) = (x \times y) + (x \times z)$.

You will notice that signed real numbers satisfy these properties but unsigned reals do not, since, for instance, there is no unsigned y satisfying $1.5 + y = 0$. Similarly neither signed nor unsigned integers form a field since, for instance, there is no y satisfying $7 \times y = 1$. However GF arithmetic does satisfy all these rules and has the valuable property that the set of elements is of finite size. For $GF(2^8)$ the number of elements is 256. Although algebra in $GF(2^8)$ feels similar to that on real numbers, you still have to be careful. For instance, $x + x$ is equal to zero and not $2 * x$.

One notable example of the use of GF arithmetic is in the Reed-Solomon Error Correcting Codes. A simple demonstration is given in the following sections. The program starts with the following declarations which declares variables that will be described later when they are used.

```

GET "libhdr"

GLOBAL {
  testno:ug      // =0 for small demo, =1 for a larger demo.

  gf_log2       // Vector of discrete logarithms in GF(2^8)

```

```

gf_exp2      // Vector of powers of 2 in GF(2^8)

n            // The codeword length in bytes
k            // The message length
e            // n-k The number of parity bytes

Msg          // The message polynomial
G            // The generator polynomial
M            // The codeword polynomial for Msg and G
R            // The received corrupted codeword polynomial
S            // The syndromes polynomial with coefficients
              //   Si = R(2^i)
T            // Temp polynomial
Lambda       // The Lambda polynomial, coeffs L1,..
Ldash        // d/dx of Lambda polynomial
Omega        // The Omega polynomial, coeffs O1,..
e_pos        // Vector of the error positions
}

```

We have already seen that addition and subtraction in $GF(2^8)$ are replaced by XOR but, for completeness, we define the following two functions.

```
LET gf_add(x, y) = x XOR y
```

```
AND gf_sub(x, y) = x XOR y
```

In $GF(2^8)$, 2 has the interesting property that all 255 elements other than 0 can be represented by 2^n for suitably chosen values of n . It is useful to precompute these powers of 2 placing them in a vector `gf_exp2` and while doing so we can construct a vector `gf_log2` holding this inverse values. These two vectors are allocated and initialised by the function `initlogs`, defined as follows.

```

AND initlogs() BE
{ LET x = 1
  gf_log2 := getvec(255)
  gf_exp2 := getvec(510) // 510 = 255+255
  // Using a double sized vector for exp2 improves the efficiency
  // of functions such as gf_mul and gf_div, defined below.

  UNLESS gf_log2 & gf_exp2 DO
  { writef("initlogs: More space needed*n")
    abort(999)
  }

  gf_log2!0 := -1 // log2 of zero is undefined.
}

```



```

FOR i = 0 TO 255 DO // All possible element values
{ // 2^i = x so i = log2(x)
  gf_exp2!i := x
  gf_exp2!(i+255) := x // Note 2^255=1 in GF(2^8)
  gf_log2!x := i
  x := x<<1 // Multiply x by 2
  UNLESS ( x & #b_1_0000_0000 ) = 0 DO
    x := x XOR #b_1_0001_1101
}
}

```

The vectors `gf_exp2` and `gf_log2` are used in the definitions of `gf_mul` defined below based on the following observation.

$$x \times y = 2^{\log_2(x)} \times 2^{\log_2(y)} = 2^{\log_2(x)+\log_2(y)}$$

Since $\log_2(0)$ is undefined, cases where x or y are zero are treated specially.

```

AND gf_mul(x, y) = VALOF
{ IF x=0 | y=0 RESULTIS 0
  RESULTIS gf_exp2!(gf_log2!x + gf_log2!y)
}

```

The functions `gf_div`, `gf_pow` and `gf_inverse` are also implemented efficiently using these vectors.

```

AND gf_div(x, y) = VALOF
{ IF y=0 DO
  { writef("gf_div: Division by zero*n")
    abort(999)
  }
  IF x=0 RESULTIS 0
  RESULTIS gf_exp2!(255 + gf_log2!x - gf_log2!y)
}

```

```

AND gf_pow(x,y) = gf_exp2!((gf_log2!x * y) MOD 255)

```

```

AND gf_inverse(x) = gf_exp2!(255 - gf_log2!x)

```

4.22 Polynomials with GF(2⁸) Coefficients

The Reed-Solomon Error Correction mechanism make extensive use of polynomials with GF coefficients, so this section presents some functions relating to such polynomials. In this implementation polynomials are represented by vectors containing the degree of the polynomial and its coefficients. If p points to

such a polynomial then $p!0$ holds its degree, n say, and $p!1$ holds the coefficient of x^n . Successive elements of p hold the coefficients of lower powers of x , with the final coefficient in $p!(n+1)$ representing the constant term. So the polynomial $5x^2 + 6x + 7$ would be represented by a vector whose elements are 2,5,6 and 7.

The first few polynomial functions are straight forward and need no additional explanation.

```

AND gf_poly_copy(p, q) BE
{ // Copy polynomial from p to q.
  FOR i = 0 TO p!0+1 DO q!i := p!i
}

AND gf_poly_scale(p, x, q) BE
{ // Multiply, using gf_mul, every coefficient of polynomial p by
  // scalar x leaving the result in q.
  LET deg = p!0 // The degree of polynomial p
  q!0 := deg // The degree of the result
  FOR i = 1 TO deg+1 DO q!i := gf_mul(p!i, x)
}

AND gf_poly_add(p, q, r) BE
{ // Add polynomials p and q leaving the result in r
  LET degp = p!0 // The number of coefficients is one larger
  LET degq = q!0 // than the degree of the polynomial.
  LET degr = degp
  IF degq > degr DO degr := degq
  // degr is the larger of the degrees of p and q.
  r!0 := degr // The degree of the result
  FOR i = 1 TO degp+1 DO r!(i+degr-degp) := p!i
  FOR i = 1 TO degr-degp DO r!i := 0 // Pad higher coeffs with 0s
  FOR i = 1 TO degq+1 DO r!(i+degr-degq) := r!(i+degr-degq) XOR q!i
}

// GF addition and subtraction are the same.
AND gf_poly_sub(p, q, r) BE gf_poly_add(p, q, r)

AND gf_poly_mul(p, q, r) BE
{ // Multiply polynomials p and q leaving the result in r
  LET degp = p!0
  LET degq = q!0
  LET degr = degp+degq

  r!0 := degr // Degree of the result
  FOR i = 1 TO degr+1 DO r!i := 0
  FOR j = 1 TO degq+1 DO

```

```

    FOR i = 1 TO degp+1 DO
        r!(i+j-1) := r!(i+j-1) XOR gf_mul(p!i, q!j)
    }

AND gf_poly_mulbyxn(p, n, r) BE
{ // Multiply polynomials p by x^n leaving the result in r
  LET degp = p!0
  LET degr = degp + n
  r!0 := degr
  FOR i = 1 TO degp+1 DO r!i := p!i
  FOR i = degp+2 TO degr+1 DO r!i := 0
}

AND gf_poly_eval(p, x) = VALOF
{ // Evaluate polynomial p for a given x using Horner's method.
  // Eg use: ax^3 + bx^2 + cx^1 + d = ((ax + b)x + c)x + d
  LET res = p!1
  FOR i = 2 TO p!0+1 DO
      res := gf_mul(res,x) XOR p!i // mul by x and add next coeff
  RESULTIS res
}

AND pr_poly(p) BE
{ // Output the polynomial in hex
  FOR i = 1 TO p!0+1 DO writef(" %x2", p!i)
  newline()
}

AND pr_poly_dec(p) BE
{ // Output the polynomial in decimal
  FOR i = 1 TO p!0+1 DO writef(" %i3", p!i)
  newline()
}

```

The function `gf_poly_divmod` divides polynomial `p` by polynomial `q` using long division leaving both the quotient and remainder in `r`.

```

AND gf_poly_divmod(p, q, r) BE
{ LET degp = p!0 // The degree of polynomial p.
  LET degq = q!0 // The degree of polynomial q.
  LET degr = degp

  LET t = VEC 255 // Vector to hold the next product of the generator

  UNLESS q!1 > 0 DO

```

```

{ writef("The divisor must have a non zero leading coefficient*n")
  abort(999)
  RETURN
}

// Copy polynomial p into r.
r!0 := degr
FOR i = 1 TO degr+1 DO r!i := p!i

//writef("p:          "); pr_poly(p)
//writef("q:          "); pr_poly(q)
//writef("r:          "); pr_poly(r)

FOR i = 1 TO degp-degq+1 DO
{ LET dig = gf_div(r!i, q!1)
  IF dig DO
  { gf_poly_scale(q, dig, t)
    //writef("scaled q: ")
    //FOR j = 2 TO i DO writef(" ")
    //pr_poly(t)
    r!i := dig
    FOR j = 2 TO t!0+1 DO r!(i+j-1) := r!(i+j-1) XOR t!j
  }
  //writef("new      r: "); pr_poly(r)
}
}
}

```

If the write statements in `gf_poly_divmod` are un-commented, it is possible to generate the following output.

```

p:          12 34 56 78 00 00 00 00 00 00
q:          71 11 22 33 44 55 66
initial r:  12 34 56 78 00 00 00 00 00 00
scaled q:   12 F4 F5 01 F7 03 02
new r:      2E C0 A3 79 F7 03 02 00 00 00
scaled q:    C0 4A 94 DE 35 7F A1
new r:      2E 82 E9 ED 29 36 7D A1 00 00
scaled q:    E9 D8 AD 75 47 9F EA
new r:      2E 82 AA 35 84 43 3A 3E EA 00
scaled q:    35 C1 9F 5E 23 E2 BC
new r:      2E 82 AA 1C 45 DC 64 1D 08 BC

```

This shows the long division steps being used to divide `p` by `q`. The quotient `2E 82 AA 1C` and remainder `45 DC 64 1D 08 BC` are left in `r`. The functions `gf_poly_div` and `gf_poly_mod` use `gf_poly_divmod` to obtain the quotient and remainder separately.

```

AND gf_poly_div(p, q, r) BE
{ gf_poly_divmod(p, q, r)
  r!0 := p!0 - q!0 // Select just the quotient
}

AND gf_poly_mod(p, q, r) BE
{ LET degp = p!0
  LET degq = q!0
  LET degr = degq - 1

  gf_poly_divmod(p, q, r)

  r!0 := degr // Overwrite the quotient with the remainder.
  FOR i = 1 TO degr+1 DO r!i := r!(i+degp-degr)
}

```

4.23 Reed-Solomon Error Correction

Reed-Solomon Error Correction takes a sequence of message elements combined with an arbitrary number of parity elements to form a codeword that can be corrected provided not too many of its elements have been corrupted. It is used in 2D QR barcodes where errors might occur as a result of the scanner misreading a damaged image, and it is also used in radio communication such as digital television where errors might occur as the result of weak signals or electrical interference. The mechanism is both efficient and almost optimal. The codewords represent polynomials whose coefficients use $GF(2^4)$ for digital television or $GF(2^8)$ for QR barcodes. This demonstration program used $GF(2^8)$ and we will assume that the elements are 8-bit bytes.

If there are e parity bytes then all errors can be found and corrected provided there are no more than $e/2$ of them. In the unusual situation where the locations of the errors are known, up to e errors can be corrected.

Assuming we have a message of k bytes, this can be represented as a polynomial of degree $k - 1$ using the message bytes as the coefficients. To add e parity bytes, we multiply the message polynomial by x^e and add the remainder after dividing it by a special generator polynomial of degree e . The generator polynomial is the expansion of:

$$(x - 2^0)(x - 2^1)(x - 2^2)\dots(x - 2^{(e-1)})$$

The following function creates the generating polynomial of degree e placing the result in g .

```

AND gf_generator_poly(e, g) BE
{ // Set in g the polynomial resulting from the expansion of
  // (x-2^0)(x-2^1)(x-2^2) ... (x-2^(e-1)). Note that it is

```

```

// of degree e and that the coefficient of x^e is 1.
LET t = VEC 255
g!0, g!1 := 0, 1 // The polynomial: 1.
FOR i = 0 TO e-1 DO
{ LET d, a, b = 1, 1, gf_pow(2,i) // (x + 2^i)
  // @d points to polynomial:      (x - 2^i)
  // which in GF arithmetic is also: (x + 2^i)
  FOR i = 0 TO g!0+1 DO t!i := g!i // Copy g into t
  gf_poly_mul(t, @d, g) // Multiply t by (x-2^i) into g
}
}

```

The function `rs_encode_msg` returns in `r` the polynomial `Msg` concatenated with the `e` Reed-Solomon check bytes which represent remainder after the `Msg` polynomial multiplied by x^e and divided by the generator polynomial created by `rs_generator_poly`. As an example with message polynomial 12 34 56 78 and `e=6`, the generator polynomial is 01 3F 01 DA 20 E3 26 and the division proceeds as follows.

```

                                12 9D 43 57
                                -----
01 3F 01 DA 20 E3 26 ) 12 34 56 78 00 00 00 00 00 00
                      12 A9 12 88 7A 4D 16
                      -----
                      9D 44 F0 7A 4D 16 00
                      9D 07 9D 3F 4A 51 23
                      -----
                      43 6D 45 07 47 23 00
                      43 3A 43 F7 88 5A 1F
                      -----
                      57 06 F0 CF 79 1F 00
                      57 11 57 99 32 67 DD
                      -----
                                17 A7 56 4B 78 DD

```

It thus computes 12 9D 43 57 as the quotient and 17 A7 56 4B 7B DD as the remainder. As can be seen, the process is basically long division using `gf_mul` for multiplication and `XOR` for subtraction. If at each stage the senior byte is not subtracted, the senior 4 bytes of the accumulator become the quotient and the junior 6 bytes hold the remainder. This assumes that the senior coefficient of the generator polynomial is always a one. If, at the end, we replace the quotient bytes of the accumulator by the original message bytes, we create the Reed-Solomon codeword.

The definition of `rs_encode_msg` is as follows.

```

AND rs_encode_msg() BE
{ // This appends e Reed-Solomon parity bytes onto the end of the
  // message bytes Msg, placing the result in M.
  LET degmsg = Msg!0 // The degree of the message polynomial.
  LET e = G!0 // e = the degree of the generator polynomial
  LET degm = degmsg+e // The degree of the RS codeword polynomial

  // Place Msg multiplied by x^e in M.
  gf_poly_mulbyxn(Msg, e, M)
  gf_poly_copy(M, T)
  gf_poly_divmod(T, G, M)
  // Copy Msg in the senior end of M replacing the bytes that
  // currently hold the quotient.
  FOR i = 1 TO degmsg+1 DO M!i := Msg!i
}

```

We have seen that a Reed-Solomon codeword consists of k bytes of message followed by e parity bytes which represent the remainder after dividing the message polynomial multiplied by x^e by the generator polynomial. Since addition and subtraction are both the same in GF arithmetic, the codeword will be exactly divisible by the generating polynomial and, since the generator polynomial is the product of many factors of the form $(1 - x * 2^i)$, each of these also divides into the codeword exactly. However, if some bytes of the codeword are corrupted, most of these factors will not divide the corrupted codeword exactly. We can easily create a polynomial of degree $e - 1$ whose coefficients are the e remainders obtained when attempting to divide the corrupted codeword by each factor of the generator polynomial.

To demonstrate how the error correction is performed, we will use an example of a 4 byte message 12 34 56 78 and 6 parity bytes. We thus have $k = 4$, $e = 6$ and so $n = 10$. The generator polynomial $G(x)$ is therefore:

$$\begin{aligned}
 G(x) &= (x - 2^0)(x - 2^1)(x - 2^2)(x - 2^3)(x - 2^4)(x - 2^5) \\
 &= (x - 01)(x - 02)(x - 04)(x - 08)(x - 10)(x - 20) \\
 &= 01x^6 + 3Fx^5 + 01x^4 + DAx^3 + 20x^2 + E3x + 26
 \end{aligned}$$

It turns out that using this generator of this form maximises the Hamming distance between codewords.

From now on we will write G for the generator, M the codeword and R the corrupted codeword as follows:

```

G = 01 3F 01 DA 20 E3 26
M = 12 34 56 78 17 A7 56 4B 78 DD
R = 12 34 00 00 17 00 56 4B 78 DD

```

You will notice that bytes 3, 4 and 6 of the codeword have been zeroed, and that these correspond to the coefficients of x^7 , x^6 and x^4 , respectively.

In general, when we attempt to read a codeword some of its bytes may be corrupted resulting in a different polynomial $R(x)$ which can be written as the sum of $M(x)$, the original codeword, and $E(x)$ an errors polynomial giving a correction value for each coefficient of R . This is stated in the following equation:

$$R(x) = M(x) + E(x)$$

Assuming the corrupted codeword is:

$$R = 12\ 34\ 00\ 00\ 17\ 00\ 56\ 4B\ 78\ DD$$

then the errors polynomial E will be:

$$E = 00\ 00\ 56\ 78\ 00\ A7\ 00\ 00\ 00\ 00$$

which when added to R gives the corrected codeword. Our problem is how to deduce the errors polynomial knowing only R and the generator polynomial. It turns out that we can, provided not too many bytes have been corrupted. With 6 check bytes we can find and correct the $6/2=3$ corrupted bytes in R .

To do this we first construct a polynomial S (called the syndromes polynomial) whose coefficients are the remainders after dividing R by each of the factors of the generator polynomial. In our example $e = 6$ so the generator has 6 factors $(x - 2^0)$, $(x - 2^1)$, $(x - 4^2)$, $(x - 2^3)$, $(x - 2^4)$ and $(x - 2^5)$. S can be written as

$$S(x) = S_5x^5 + S_4x^4 + S_3x^3 + S_2x^2 + S_1x + S_0$$

When we divide R by $(x - 2^i)$ we obtain a quotient polynomial Q_i and a remainder S_i . These, of course, satisfy the following equation:

$$R(x) = (x - 2^i) * Q_i(x) + S_i$$

and if we set $x = 2^i$ this reduces to

$$R(2^i) = S_i$$

So S_i can be calculated just by evaluating the polynomial $R(x)$ at $x = 2^i$. For our example the syndromes polynomial is:

$$S = 2E\ B8\ 0E\ CB\ 50\ 35$$

If we happen to know in advance the positions in the codeword that have been corrupted, in this case 3, 4 and 6, then we could write the errors polynomial as

$$E(x) = Y1*x^7 + Y2*x^6 + Y3*x^4$$

Hopefully there is sufficient information to deduce these positions and $Y1=56$, $Y2=78$ and $Y3=A7$.

Since we have just shown $E(2^i) = S_i$, and assuming we know the error positions, we can say

$$\begin{aligned}
 S_i &= E(2^i) \\
 &= Y_1 \cdot 2^{(7 \cdot i)} + Y_2 \cdot 2^{(6 \cdot i)} + Y_3 \cdot 2^{(4 \cdot i)} \\
 &= Y_1 \cdot X_1^i + Y_2 \cdot X_2^i + Y_3 \cdot X_3^i
 \end{aligned}$$

where $X_1 = 2^7$, $X_2 = 2^6$ and $X_3 = 2^4$

These 6 equations can be written as a matrix product as follow

$$\begin{aligned}
 (S_0) &= (X_1^0 \ X_2^0 \ X_3^0) \times (Y_1) \\
 (S_1) &= (X_1^1 \ X_2^1 \ X_3^1) \quad (Y_2) \\
 (S_2) &= (X_1^2 \ X_2^2 \ X_3^2) \quad (Y_3) \\
 (S_3) &= (X_1^3 \ X_2^3 \ X_3^3) \\
 (S_4) &= (X_1^4 \ X_2^4 \ X_3^4) \\
 (S_5) &= (X_1^5 \ X_2^5 \ X_3^5)
 \end{aligned}$$

We know that $S = 2E \ B8 \ 0E \ CB \ 50 \ 35$ and assuming we know that $X_1=2^7$, $X_2=2^6$ and $X_3=2^4$, this product simplifies to

$$\begin{aligned}
 (2E) &= (2^0 \ 2^0 \ 2^0) \times (Y_1) \\
 (B8) &= (2^7 \ 2^6 \ 2^4) \quad (Y_2) \\
 (0E) &= (2^{14} \ 2^{12} \ 2^8) \quad (Y_2) \\
 (CB) &= (2^{21} \ 2^{18} \ 2^{12}) \\
 (50) &= (2^{28} \ 2^{24} \ 2^{16}) \\
 (35) &= (2^{35} \ 2^{30} \ 2^{20})
 \end{aligned}$$

or

$$\begin{aligned}
 (2E) &= (01 \ 01 \ 01) \times (Y_1) \\
 (B8) &= (80 \ 40 \ 10) \quad (Y_2) \\
 (0E) &= (13 \ CD \ 1D) \quad (Y_2) \\
 (CB) &= (75 \ 2D \ CD) \\
 (50) &= (18 \ 8F \ 4C) \\
 (35) &= (9C \ 60 \ B4)
 \end{aligned}$$

If these equations are consistent and non singular they can be solved. The solution in this case turns out to be $Y_1=56$, $Y_2=78$ and $Y_3=A7$, as expected.

These values for Y_1 , Y_2 and Y_3 tells us that $E(x)=56 \cdot x^7 + 78 \cdot x^6 + A7 \cdot x^4$ giving us the required result

$$E = 00 \ 00 \ 56 \ 78 \ 00 \ A7 \ 00 \ 00 \ 00 \ 00$$

which when added to

$$R = 12 \ 34 \ 00 \ 00 \ 17 \ 00 \ 56 \ 4B \ 78 \ DD$$

give use the corrected codeword

$$T = 12 \ 34 \ 56 \ 78 \ 17 \ A7 \ 56 \ 4B \ 78 \ DD$$

It turns out that if we know the locations of 6 error, we could correct all 6. But, as is usually the case, we do not know the location of any of them we have more work to do.

The following functions calculate the syndromes polynomial and use it to confirm the accuracy the description just given.

```

AND rs_calc_syndromes(codeword, e, s) BE
{ // e = the number of error correction bytes
  //writef("*nrs_calc_syndromes:*n")
  //writef("codeword: "); pr_poly(codeword)
  LET degs = e-1
  s!0 := degs // The degree of the syndromes polynomial.
  FOR i = 0 TO e-1 DO
  { LET p2i = gf_pow(2,i)
    LET res = gf_poly_eval(codeword, p2i)
    //writef("%i2 2^i = %x2 => %x2 %i3*n", i, p2i, res, res)
    //s!(i+1) := res // s!(i+1) = codeword(2^i)
    s!(degs+1-i) := res // si = codeword(2^i)
  }
}
}

```

The typesetting of the following needs more work.

/*

Our problem is now to try and find the locations of errors in the corrupted codeword using only its syndomes polynomial and the generator polynomial.

It is common in mathematics and computing to pick out a seemingly unrelated construct, as if by magic, and after a little elementary manipulation suddenly realise it is just what we want.

Let us assume there are three locations e1, e2 and e3 containing corrupted bytes in the codeword. Let us now consider the following polynomial.

$$\begin{aligned} \text{Lambda}(x) &= (1+x*2^{e1})(1+x*2^{e2})(1+x*2^{e3}) \\ &= 1 + L1*x + L2*x^2 + L3*x^3 \end{aligned}$$

This polynomial is zero when $x=2^{-e1}$, or $x=2^{-e2}$ or $x=2^{-e3}$. If we write $Xi=2^{-ei}$, we can say the root of this $\text{Lambda}(x)=0$ are $X1^{-1}$, $X2^{-1}$ and $X3^{-1}$. Knowing the roots allows us the write the following:

$$1 + L_1*2^{-ej} + L_2*2^{-2ej} + L_3*2^{-3ej} = 0$$

If we multiply this equation by $Y_j*2^{(i+3)ej}$, we get

$$Y_j*2^{(i+3)ej} + L_1*Y_j*2^{(i+2)ej} + L_2*Y_j*2^{(i+1)ej} + L_3*Y_j*2^{ie_j} = 0$$

If we write these for each value of j , we get

$$Y_1*2^{(i+3)e_1} + L_1*Y_1*2^{(i+2)e_1} + L_2*Y_1*2^{(i+1)e_1} + L_3*Y_1*2^{ie_1} = 0$$

$$Y_2*2^{(i+3)e_2} + L_1*Y_2*2^{(i+2)e_2} + L_2*Y_2*2^{(i+1)e_2} + L_3*Y_2*2^{ie_2} = 0$$

$$Y_3*2^{(i+3)e_3} + L_1*Y_3*2^{(i+2)e_3} + L_2*Y_3*2^{(i+1)e_3} + L_3*Y_3*2^{ie_3} = 0$$

or

$$Y_1*(2^{(i+3)})^{e_1} + L_1*Y_1*(2^{(i+2)})^{e_1} + L_2*Y_1*(2^{(i+1)})^{e_1} + L_3*Y_1*(2^i)^{e_1} = 0$$

$$Y_2*(2^{(i+3)})^{e_2} + L_1*Y_2*(2^{(i+2)})^{e_2} + L_2*Y_2*(2^{(i+1)})^{e_2} + L_3*Y_2*(2^i)^{e_2} = 0$$

$$Y_3*(2^{(i+3)})^{e_3} + L_1*Y_3*(2^{(i+2)})^{e_3} + L_2*Y_3*(2^{(i+1)})^{e_3} + L_3*Y_3*(2^i)^{e_3} = 0$$

Remembering that

$$E(x) = Y_1*x^{e_1} + Y_2*x^{e_2} + Y_3*x^{e_3}$$

We can add these equations together giving:

$$E(2^{(i+3)}) + L_1*E(2^{(i+2)}) + L_2*E(2^{(i+1)}) + L_3*E(2^i) = 0$$

We thus have the 3 following equations by setting i to 0, 1 and 2.

$$E(2^3) + L_1*E(2^2) + L_2*E(2^1) + L_3*E(2^0) = 0$$

$$E(2^4) + L_1*E(2^3) + L_2*E(2^2) + L_3*E(2^1) = 0$$

$$E(2^5) + L_1*E(2^4) + L_2*E(2^3) + L_3*E(2^2) = 0$$

Since we know $E(2^i) = R(2^i)$, these become:

$$R(2^3) + L_1*R(2^2) + L_2*R(2^1) + L_3*R(2^0) = 0$$

$$R(2^4) + L_1*R(2^3) + L_2*R(2^2) + L_3*R(2^1) = 0$$

$$R(2^5) + L_1*R(2^4) + L_2*R(2^3) + L_3*R(2^2) = 0$$

which is the same as:

$$S_3 + L_1*S_2 + L_2*S_1 + L_3*S_0 = 0$$

$$S_4 + L_1*S_3 + L_2*S_2 + L_3*S_1 = 0$$

$$S_5 + L_1*S_4 + L_2*S_3 + L_3*S_2 = 0$$

These equations can be written in matrix form as follows:

$$\begin{pmatrix} S_3 \\ S_4 \\ S_5 \end{pmatrix} = \begin{pmatrix} S_2 & S_1 & S_0 \\ S_3 & S_2 & S_1 \\ S_4 & S_3 & S_2 \end{pmatrix} x \begin{pmatrix} L_1 \\ L_2 \\ L_3 \end{pmatrix}$$

Provided the 3x3 matrix is not singular, the equations can be solved giving us the values of L1, L2 and L3. We now have the equation

$$\text{Lambda}(x) = 1 + L_1x + L_2x^2 + L_3x^3$$

completely defined and we can therefore find its roots 2^{-e_1} , 2^{-e_2} and 2^{-e_3} and hence deduce the error positions e_1 , e_2 and e_3 . We can easily find the root by trial and error since there are only n possible values for each e_i , where n is the length of the codeword.

For our example, the equations matrix equation is

$$\begin{pmatrix} 6E \\ 82 \\ 7A \end{pmatrix} = \begin{pmatrix} DE & 81 & 89 \\ 6E & DE & 81 \\ 82 & 6E & DE \end{pmatrix} x \begin{pmatrix} L_1 \\ L_2 \\ L_3 \end{pmatrix}$$

giving L1=D0, L2=1B and L3=98.

In general, we do not know how many errors there are. If there are fewer than 3 the 3x3 matrix will have a zero determinant and we will have to try for 2 errors, but if the top left 2x2 determinant is zero, we will have to try the top left 1x1 matrix.

The solution, if any, of this matrix equation is normally solved using Berlekamp-Massey algorithm, described later.

*/

```

AND rs_find_error_locator() BE
{ // This sets Lambda to the error locator polynomial
  // using the syndromes polynomial in S. It is only used
  // when we do not know the locations of any of the
  // error bytes, so the maximum number of error that
  // can be found is the (S!0+1)/2. It uses the
  // Berlekamp-Massey algorithm.
  LET old_loc = VEC 50
  LET degs    = S!0
  LET k, 1    = 1, 0
  LET newL    = VEC 50 // To hold the error locator polynomial

```

```

LET C      = VEC 50 // To hold a correction polynomial
LET P1     = VEC 50

//writef("*nComputing the error locator polynomial Lambda*n")
//writef("using the Berlekamp-Massey algorithm.*n*n")

Lambda!0, Lambda!1 := 0, 1 // Polynomial: Lambda(x) = 1
C!0, C!1, C!2 := 1, 1, 0 // Polynomial: C(x) = x+0

UNTIL k > degs+1 DO // degs+1 = number of correction bytes
{ LET delta = 0//S!(degs+1) // S0 = R(2^0)
  LET degL = Lambda!0
  //newline()
  //writef("Lambda: "); pr_poly(Lambda)
  //writef("R:      "); pr_poly(R)
  //writef("S:      "); pr_poly(S)
  //writef("k=%n l=%n*n", k, l)

  // First calculate delta
  FOR i = 0 TO l DO
  { LET Li = Lambda!(degL+1-i) // Li -- Coeff of x^i in current Lambda
    LET f = S!(degs+1 - (k-1-i)) // R(2^(k-1-i))
    LET Lif = gf_mul(Li, f)
    //writef("i=%n delta: %x2*n", i, delta)
    delta := delta XOR Lif
    //writef("i=%n Li=%x2 f=%x2 Lif=%x2 => delta=%x2*n",
    //      i, Li, f, Lif, delta)
  }
  //writef("delta: %x2*n", delta)

  IF delta DO
  { gf_poly_scale(C, delta, P1)
    //writef("Multiply R by delta=%x2 giving: ", delta); pr_poly(P1)
    gf_poly_add(P1, Lambda, newL)
    //writef("Add L giving newL          "); pr_poly(newL)
    IF 2*1 < k DO
    { l := k-1
      gf_poly_scale(Lambda, gf_inverse(delta), C)
      //writef("Since 2x1 < k set C = Lambda/delta: "); pr_poly(C)
    }
  }
}

// Multiply C by x
C!0 := C!0 + 1
C!(C!0+1) := 0

```

```

//writef("Multiply C by x giving: "); pr_poly(C)

FOR i = 0 TO newL!0+1 DO Lambda!i := newL!i
//writef("Set new version of Lambda:  "); pr_poly(Lambda)
k := k+1
}
}

AND rs_find_error_evaluator() BE
{ // Compute the error evaluator polynomial Omega
  // using S and Lambda.

  // Omega(x) = (S(x) * Lambda(x)) MOD x^(e+1)
  LET degs = S!0

  // This could be optimised since we are going to
  // through away many of the terms in the product.
  gf_poly_mul(S, Lambda, Omega)
  writef("S:          "); pr_poly(S)
  writef("Lambda:     "); pr_poly(Lambda)
  writef("S x Lambda: "); pr_poly(Omega)
  // Remove terms of degree higher than e
  FOR i = 0 TO degs DO Omega!(i+1) := Omega!(i+1+Omega!0-degs)
  Omega!0 := degs
  writef("Omega:      "); pr_poly(Omega)
}

AND rs_demo() BE
{ // This will test Reed-Solomon decoding typically using
  // either (n,k) = (9,6) or (26,10) depending on testno.

  LET v = getvec(1000)

  writef("reedsolomon entered*n")

  S      := v      // For the syndromes polynomial
  M      := v + 100 // For the codeword for msg
  R      := v + 200 // For the corrupted codeword
  G      := v + 300 // For the generator polynomial
  Lambda := v + 400 // For the erasures polynomial
  Ldash  := v + 500 // For d/dx of Lambda
  Omega  := v + 600 // For the evaluator polynomial
  e_pos  := v + 700 // For the error positions

```

```

T      := v + 800 // temp polynomial

// A simple test
Msg := TABLE 3, #x12, #x34, #x56, #x78
e := 6

IF testno>0 DO
{ // A larger test from the QR barcode given above.
  Msg := TABLE 15, #x40, #xD2, #X75, #x47, #x76, #x17, #x32, #x06,
          #x27, #x26, #x96, #xC6, #xC6, #x96, #x70, #xEC
  e := 10
}

k := Msg!0 + 1 // Message bytes
n := k+e      // codeword bytes

gf_generator_poly(e, G) // Compute the generator polynomial
newline()
//writef("generator: "); pr_poly(G) // 01 3F 01 DA 20 E3 26
//newline()
writef("message:  "); pr_poly(Msg) // 12 34 56 78

rs_encode_msg() // Compute in R the RS codeword for Msg.

writef("codeword: "); pr_poly(M) // 12 34 56 78 17 A7 56 4B 78 DD
FOR i = 0 TO M!0+1 DO R!i := M!i
R!3 := 0
R!4 := #xAA
R!6 := 0
IF testno>0 DO
{ // Try 5 errors in all
  R!12 := 0
  R!26 := 0
}
newline()
writef("corrupted: "); pr_poly(R) // 12 34 00 00 17 00 56 4B 78 DD
rs_calc_syndromes(R, e, S) // syndromes of polynomial R

writef("syndromes: "); pr_poly(S) // 7A 82 6E DE 81 89

// Typically: Lambda(x) = L3**x^3 + L2**x^2 + L1**x^1 + 1

writef("*nLambda(x) = ")
FOR i = e/2 TO 1 BY -1 DO
  writef("L%n**x^n + ", i, i)

```

```

writef("1*n")

writef("nIt can be shown that:n*n")

FOR row = 0 TO e/2-1 DO
{ writef("( S%n ) ", row+e/2)
  wrch(row=0 -> '=', ' ')
  writef(" (")
  FOR col = e/2-1 TO 0 BY -1 DO writef(" S%n", col+row)
  writef(" ) ")
  wrch(row=0 -> 'x', ' ')
  writef(" ( L%n )*n", row+1)
}

newline()

writef("nwhere ")
FOR i = e-1 TO 0 BY -1 DO writef("S%n ", i)
writef("= ")
FOR i = e-1 TO 0 BY -1 DO writef("%x2 ", gf_poly_eval(R, gf_exp2!i))
writef("n*n")

FOR row = 0 TO e/2-1 DO
{ writef("( %x2 ) ", gf_poly_eval(R, gf_exp2!(row+e/2)))
  wrch(row=0 -> '=', ' ')
  writef(" (")
  FOR col = e/2-1 TO 0 BY -1 DO writef(" %x2", gf_poly_eval(R, gf_exp2!(col+row)))
  writef(" ) ")
  wrch(row=0 -> 'x', ' ')
  writef(" ( L%n )*n", row+1)
}

newline()
writef("nThis can be solved using the Berlekamp-Massey algorithm.n")

rs_find_error_locator()
writef("nLambda: "); pr_poly(Lambda) // 98 1B D0 01

writef("So ")
FOR i = 1 TO e/2 DO writef(" L%n=%x2", i, Lambda!(e/2+1-i))
writef("nand")
FOR i = 0 TO e-1 DO writef(" S%n=%x2", i, S!(S!0+1-i))
writef("n*n")

```



```

FOR row = 0 TO e/2-1 DO
{ LET a = 0
  FOR i = 0 TO e/2-1 DO
  { LET b = gf_poly_eval(R, gf_exp2!(e/2-1-i+row))
    LET c = Lambda!(Lambda!0-i)
    a := a XOR gf_mul(b,c)
    writef("%x2**%x2", b,c)
    TEST i=e/2-1
    THEN writef(" = %x2    -- S%n = %x2*n",
                a, e/2+row, gf_poly_eval(R, gf_exp2!(e/2+row)))
    ELSE writef(" + ")
  }
}

writef("nIf the coeff of x^i in R(x) is corrupt then*
      * Lambda(2^-i) should be zero.*n*n")

writef("The solutions of Lambda(x)=0 can be solved by trial and error*n*n")

e_pos!0 := -1 // No error positions yet found.
FOR i = 0 TO R!0 DO
{ LET Xi = gf_exp2!i
  LET a = gf_poly_eval(Lambda, gf_inverse(Xi))
  IF a=0 DO
  { writef("Lambda(2^-%i2) = 0*n", i)
    e_pos!0 := e_pos!0+1
    e_pos!(e_pos!0+1) := i
  }
}

writef("nSo the error locations numbered from the left are: ")
pr_poly_dec(e_pos)
newline()

rs_find_error_evaluator(S, Lambda, Omega)
newline()

writef("Checking Omega*n*n")

FOR row = 0 TO e/2-1 DO
{ LET sum = 0
  writef("0%n = %x2    ", row, Omega!(Omega!0+1-row))
  FOR i = 0 TO row DO
  { LET Li = Lambda!(Lambda!0+1-i)
    LET Sj = S!(S!0+1+i-row)

```

```

    IF i>0 DO writef(" + ")
    writef("%x2**%x2", Sj, Li)
    sum := sum XOR gf_mul(Sj, Li)
  }
  writef(" = %x2*n", sum)
}
newline()

writef("Lambda:      "); pr_poly(Lambda)

writef("The formal differential of Lambda(x) is*n*n")
writef("Ldash(x) = L1 + 2**L2**x^1 + 3**L3**x^2 + *
          *4**L4**x^3 + 5**L5**x^4 + ...*n")
writef("but here 2=1+1=0, 3=1+1+1=1, 4=1+1+1+1=0, etc, so:*n")
writef("Ldash(x) = L1 + L3**x^2 + L5**x^4 + ...*n*n")

gf_poly_copy(Lambda, Ldash)
// Clear the coefficients of the even powers
FOR i = Ldash!0+1 TO 1 BY -2 DO Ldash!i := 0
// Divide through by x
Ldash!0 := Ldash!0 - 1
writef("Ldash:      "); pr_poly(Ldash)

writef("nLet Xi = 2^i and invXi = 2^-i*n")
writef("nIf Lambda(invXi) = 0, i will correspond to*
      * the position of an error in R*n*n")

writef("To correct the coefficient at this position*
      * we subtract Yi defined as follows:*n")
writef("Yi = Xi ** Omega(invXi) / Ldash(invXi)*n")

newline()
FOR i = 0 TO R!0 DO
{ LET j = R!0 + 1 - i // Position in R counting from the left.
  LET Xi = gf_exp2!i
  LET invXi = gf_inverse(Xi)
  LET LambdaInvXi = gf_poly_eval(Lambda, invXi)
  IF LambdaInvXi = 0 DO
  { LET OmegaInvXi = gf_poly_eval(Omega, invXi)
    LET LdashInvXi = gf_poly_eval(Ldash, invXi)
    LET q = gf_div(OmegaInvXi, LdashInvXi)
    LET Yi = gf_mul(Xi, q)
    writef("j=%i2 i=%i2 Xi=%x2 invXi=%x2 OmegaInvXi=%x2*
          * LdashInvXi=%x2 q=%x2 Yi=%x2*n",

```

```

        j, i, Xi, invXi, OmegaInvXi, LdashInvXi, q, Yi)
    writef("So add %x2 to %x2 at position %i2 in R to give %x2*n*n",
          Yi, R!j, j, R!j XOR Yi)
    R!j := R!j XOR Yi // Subtract Yi
  }
}

newline()
writef("Corrected R: "); pr_poly(R)
writef("Original M: "); pr_poly(M)

freevec(v)
}

```

```

AND start() = VALOF
{ LET argv = VEC 50

  UNLESS rdargs("testno/n", argv, 50) DO
  { writef("*nBad arguments for qr*n")
    RESULTIS 0
  }

  testno := 0
  IF argv!0 DO testno := !argv!0 // testno/n

  newline()
  initlogs()

  rs_demo()

  IF gf_log2 DO freevec(gf_log2)
  IF gf_exp2 DO freevec(gf_exp2)

  RESULTIS 0
}

```

```

/*
The following shows the compilation and execution of this program.
For the larger example use: reedsolomon 1

```

```

solestreet:$ cintsys

```

```
0.000> c b reedsolomon
bcpl reedsolomon.b to reedsolomon hdrs BCPLHDRS t32

BCPL (10 Oct 2014) with simple floating point
Code size = 5096 bytes of 32-bit little ender Cintcode
0.070> reedsolomon
```

```
reedsolomon entered
```

```
message: 12 34 56 78
generator: 01 3F 01 DA 20 E3 26
```

```
initial M: 12 34 56 78 00 00 00 00 00 00
scaled G: 12 A9 12 88 7A 4D 16
new M: 12 9D 44 F0 7A 4D 16 00 00 00
scaled G: 9D 07 9D 3F 4A 51 23
new M: 12 9D 43 6D 45 07 47 23 00 00
scaled G: 43 3A 43 F7 88 5A 1F
new M: 12 9D 43 57 06 F0 CF 79 1F 00
scaled G: 57 11 57 99 32 67 DD
new M: 12 9D 43 57 17 A7 56 4B 78 DD
codeword: 12 34 56 78 17 A7 56 4B 78 DD
```

```
corrupted: 12 34 00 AA 17 00 56 4B 78 DD
syndromes: 4B 7D 8B BD 54 23
```

$$\text{Lambda}(x) = L3*x^n + L2*x^{n-1} + L1*x^{n-2} + 1$$

It can be shown that:

$$\begin{pmatrix} S3 \\ S4 \\ S5 \end{pmatrix} = \begin{pmatrix} S2 & S1 & S0 \end{pmatrix} \times \begin{pmatrix} L1 \\ L2 \\ L3 \end{pmatrix}$$

where $S5 \ S4 \ S3 \ S2 \ S1 \ S0 = 4B \ 7D \ 8B \ BD \ 54 \ 23$

$$\begin{pmatrix} 8B \\ 7D \\ 4B \end{pmatrix} = \begin{pmatrix} BD & 54 & 23 \end{pmatrix} \times \begin{pmatrix} L1 \\ L2 \\ L3 \end{pmatrix}$$

This can be solved using the Berlekamp-Massey algorithm.

```
Lambda: 98 1B D0 01
```

So $L1=D0$ $L2=1B$ $L3=98$
 and $S0=23$ $S1=54$ $S2=BD$ $S3=8B$ $S4=7D$ $S5=4B$

$BD*D0 + 54*1B + 23*98 = 8B$ -- $S3 = 8B$
 $8B*D0 + BD*1B + 54*98 = 7D$ -- $S4 = 7D$
 $7D*D0 + 8B*1B + BD*98 = 4B$ -- $S5 = 4B$

If the coeff of x^i in $R(x)$ is corrupt then $\Lambda(2^{-i})$ should be zero.

The solutions of $\Lambda(x)=0$ can be solved by trial and error

$\Lambda(2^{-4}) = 0$
 $\Lambda(2^{-6}) = 0$
 $\Lambda(2^{-7}) = 0$

So the error locations numbered from the left are: 4 6 7

S: 4B 7D 8B BD 54 23
 Lambda: 98 1B D0 01
 S x Lambda: C8 5B D8 00 00 00 0F 26 23
 Omega: 00 00 00 0F 26 23

Checking Omega

$00 = 23$ $23*01 = 23$
 $01 = 26$ $54*01 + 23*D0 = 26$
 $02 = 0F$ $BD*01 + 54*D0 + 23*1B = 0F$

Lambda: 98 1B D0 01

The formal differential of $\Lambda(x)$ is

$Ldash(x) = L1 + 2*L2*x^1 + 3*L3*x^2 + 4*L4*x^3 + 5*L5*x^4 + \dots$
 but here $2=1+1=0$, $3=1+1+1=1$, $4=1+1+1+1=0$, etc, so:
 $Ldash(x) = L1 + L3*x^2 + L5*x^4 + \dots$

Ldash: 98 00 D0

Let $X_i = 2^i$ and $invX_i = 2^{-i}$

If $\Lambda(invX_i) = 0$, i will correspond to the position of an error in R

To correct the coefficient at this position we subtract Y_i defined as follows:
 $Y_i = X_i * \Omega(invX_i) / Ldash(invX_i)$

$j=6$ $i=4$ $X_i=10$ $invX_i=D8$ $\Omega(invX_i)=09$ $Ldash(invX_i)=EA$ $q=38$ $Y_i=A7$

So add A7 to 00 at position 6 in R to give A7

j= 4 i= 6 Xi=40 invXi=36 OmegaInvXi=B8 LdashInvXi=F0 q=28 Yi=D2

So add D2 to AA at position 4 in R to give 78

j= 3 i= 7 Xi=80 invXi=1B OmegaInvXi=51 LdashInvXi=D8 q=79 Yi=56

So add 56 to 00 at position 3 in R to give 56

Corrected R: 12 34 56 78 17 A7 56 4B 78 DD

Original M: 12 34 56 78 17 A7 56 4B 78 DD

0.020>

*/

4.24 The Queens Problem

A well known problem is to count the number of different ways in which eight queens can be placed on an 8×8 chess board without any two of them sharing the same row, column or diagonal. It was, for instance, used as a case study in Niklaus Wirth's classic paper "Program development by stepwise refinement" published in the Communications of the ACM in 1971. None of his solutions used either recursion or bit pattern techniques.

The following program solves a slight generalisation of the problem for board sizes from 1×1 to 12×12 .

```

GET "libhdr"

GLOBAL {
    count:ug
    all
}

LET try(ld, col, rd) BE
    TEST row=all
    THEN count := count + 1
    ELSE { LET poss = all & ~(ld | col | rd)
        WHILE poss DO
            { LET p = poss & -poss
                poss := poss - p
                try(ld+p << 1, col+p, rd+p >> 1)
            }
        }
    }

LET start() = VALOF
{ all := 1

    FOR i = 1 TO 12 DO
    { count := 0
        try(0, 0, 0)
        writef("Number of solutions to %i2-queens is %i9*n", i, count)
        all := 2*all + 1
    }

    RESULTIS 0
}

```

The program performs a walk over a complete tree of valid (partial) board positions, incrementing `count` whenever a complete solution is found. The root of the tree is said to be at level 0 representing the empty board. The root has successors (or children) corresponding to the board states with one queen placed in the bottom row. These are all said to be at level 1. Each level 1 state has successors corresponding to valid board states with queens placed in the bottom two rows. In general, any valid board state at level i ($i > 0$) contain i queens in the bottom i rows and is a successor of a board state at level $i - 1$. The solutions to the n -queens problem are the valid board states at level n when all n queens have been validly placed. Ignoring symmetries, all these solutions are distinct.

The walk over the tree of valid board states can be done without actually building the tree. It is done using the function `try` whose arguments `ld`, `col` and `rd` contain sufficient information about the current board state for its successors to be explored. Figure 4.5 illustrated how `ld`, `col` and `rd` are used to find where a queen can be validly placed in the current row without being attacked by any queen placed in earlier rows. `col` is a bit pattern containing a one in for each column that is already occupied. `ld` contains a one for each position attacked along a left going diagonal, while `rd` contains diagonal attacks from the other diagonal. The expression `(ld | col | rd)` is a bit pattern containing ones in

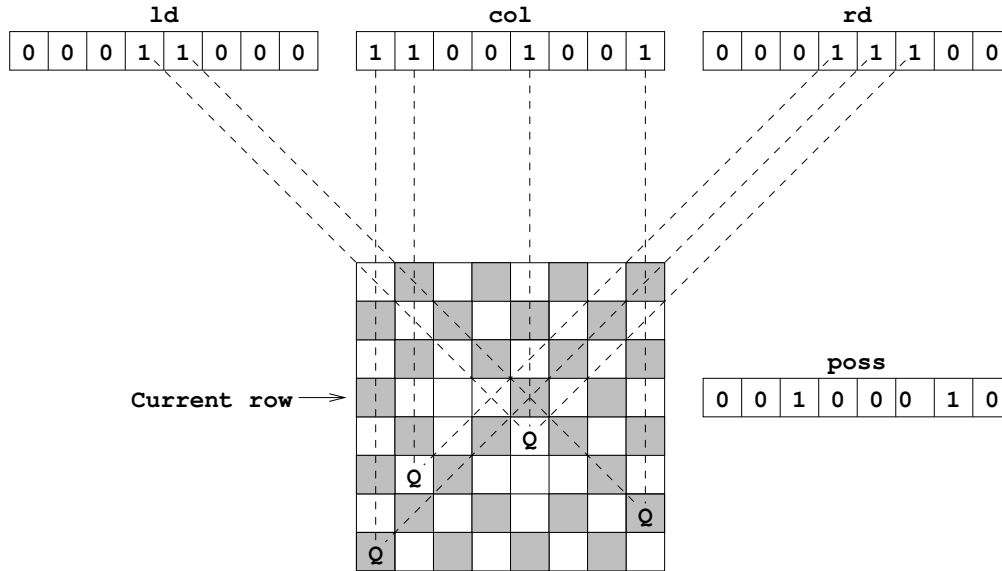

Figure 4.5: The Eight Queens

all positions that are under attack from anywhere. When this is complemented and masked with `all`, a bit pattern is formed that gives the positions in the current row where a queen can be placed without being attacked. The variable `poss` is given this as its initial value by the declaration:

```
LET poss = ~(ld | col | rd) & all
```

The `WHILE` loop cunningly iterates over these possible placements, only executing the body of the loop as many times as needed. Notice that the expression `poss & -poss` yields the least significant one in `poss`, as is shown in the following example.

```

poss      00100010
  -poss   11011110
  -----
poss & -poss 00000010
```

The position of a valid queen placement is held in `bit` and removed from `poss` by:

```

LET bit = poss & -poss
  poss := poss - bit
```

and then a recursive call of `try` is made to explore the selected successor state.

```
try( (ld|bit)<<1, col|bit, (rd|bit)>>1 )
```

Notice that a left shift is needed for the left going diagonal attacks and a right shift for the other diagonal attacks.

When `col=all` a complete solution has been found and so the count of solutions is incremented.

The main function `start` calls `try` to solve the n -queens problem for $1 \leq n \leq 12$. The output is as follows:

```
Number of solutions to 1-queens is      1
Number of solutions to 2-queens is      0
Number of solutions to 3-queens is      0
Number of solutions to 4-queens is      2
Number of solutions to 5-queens is     10
Number of solutions to 6-queens is      4
Number of solutions to 7-queens is     40
Number of solutions to 8-queens is     92
Number of solutions to 9-queens is    352
Number of solutions to 10-queens is    724
Number of solutions to 11-queens is   2680
Number of solutions to 12-queens is  14200
```

4.25 Sudoku

This section presents a program to solve the sudoku puzzles which appear in most newspapers. The logic of the program is rather similar to that of the n -queens program given in the previous section. It just attempts to fill in the cells with valid digits from left to right and top to bottom, backtracking when necessary. As with the queens program, it gains some efficiency by using bit pattern techniques. This rather naive approach usually finds solutions quickly and so a faster algorithm is hardly worth implementing (but might be fun to attempt). The program is called `sudoku.b` and hopefully has sufficient comments to make it understandable without additional description.

```
// This is a really naive program to solve Su Doku problems
// as set in many newspapers.

// Implemented in BCPL by Martin Richards (c) January 2005

// Modified 4 August 2014

// It consists of a 9x9 grid of cells. Each cell should contain
// a digit in the range 1..9. Every row, column and major 3x3
// square should contain all the digits 1..9. Some cells have
// given values. The problem is to find digits to place in
// the unspecified cells satisfying the constraints.

// A typical problem is:
```

```

// - - -   6 3 8   - - -
// 7 - 6   - - -   3 - 5
// - 1 -   - - -   - 4 -

// - - 8   7 1 2   4 - -
// - 9 -   - - -   - 5 -
// - - 2   5 6 9   1 - -

// - 3 -   - - -   - 1 -
// 1 - 5   - - -   6 - 8
// - - -   1 8 4   - - -

// The above problem is solved by the command:

// sudoku 000638000 706000305 010000040   -- all on one line
//          008712400 090000050 002569100
//          030000010 105000608 000184000

SECTION "sudoku"

GET "libhdr"

GLOBAL { count:ug

// The 9x9 board consisting of 81 cells

a1; a2; a3; a4; a5; a6; a7; a8; a9
b1; b2; b3; b4; b5; b6; b7; b8; b9
c1; c2; c3; c4; c5; c6; c7; c8; c9
d1; d2; d3; d4; d5; d6; d7; d8; d9
e1; e2; e3; e4; e5; e6; e7; e8; e9
f1; f2; f3; f4; f5; f6; f7; f8; f9
g1; g2; g3; g4; g5; g6; g7; g8; g9
h1; h2; h3; h4; h5; h6; h7; h8; h9
i1; i2; i3; i4; i5; i6; i7; i8; i9

rowabits; col1bits; squ1bits
rowbbits; col2bits; squ2bits
rowcbits; col3bits; squ3bits
rowdbits; col4bits; squ4bits
rowebits; col5bits; squ5bits
rowfbits; col6bits; squ6bits
rowgbits; col7bits; squ7bits
rowhbits; col8bits; squ8bits

```

```

rowibits; col9bits; squ9bits
}

MANIFEST {
N1 = #b_000000001 // Bit patterns representing the 9 digits
N2 = #b_000000010
N3 = #b_000000100
N4 = #b_000001000
N5 = #b_000010000
N6 = #b_000100000
N7 = #b_001000000
N8 = #b_010000000
N9 = #b_100000000

All = N1+N2+N3+N4+N5+N6+N7+N8+N9
}

LET start() = VALOF
{ LET argv = VEC 50

  LET r1 = 000_638_000 // The default board setting
  LET r2 = 706_000_305
  LET r3 = 010_000_040
  LET r4 = 008_712_400
  LET r5 = 090_000_050
  LET r6 = 002_569_100
  LET r7 = 030_000_010
  LET r8 = 105_000_608
  LET r9 = 000_184_000

  //LET r1 = 000_000_000 // This version of row 1 gives 14 solutions
  //LET r9 = 000_000_000 // This version of row 9 gives 46 solutions
  // If both row 1 and row 9 are all zeroes
  // there are 2096 solutions.

  UNLESS rdargs("r1/n,r2/n,r3/n,r4/n,r5/n,r6/n,r7/n,r8/n,r9/n",
    argv, 50) DO
  { writef("Bad arguments for SUDOKU*n")
    RESULTIS 0
  }

  IF argv!0 DO
  { // Set the board from the arguments
    r1,r2,r3,r4,r5,r6,r7,r8,r9 := 0,0,0,0,0,0,0,0,0
    IF argv!0 DO r1 := !(argv!0)
  }
}

```

```

    IF argv!1 DO r2 := !(argv!1)
    IF argv!2 DO r3 := !(argv!2)
    IF argv!3 DO r4 := !(argv!3)
    IF argv!4 DO r5 := !(argv!4)
    IF argv!5 DO r6 := !(argv!5)
    IF argv!6 DO r7 := !(argv!6)
    IF argv!7 DO r8 := !(argv!7)
    IF argv!8 DO r9 := !(argv!8)
}

initboard(r1,r2,r3,r4,r5,r6,r7,r8,r9)
writef("*nInitial board*n")
prboard()
count := 0
tal()
writef("*n*nTotal number of solutions: %n*n", count)
RESULTIS 0
}

AND setrow(row, r) BE
{ LET tab = TABLE 0, N1, N2, N3, N4, N5, N6, N7, N8, N9
  FOR i = 8 TO 0 BY -1 DO
    { LET n = r MOD 10
      r := r/10
      row!i := tab!n
    }
}

AND initboard(r1,r2,r3,r4,r5,r6,r7,r8,r9) BE
{ // Give all 81 cells their initial settings
  setrow(@a1, r1)
  setrow(@b1, r2)
  setrow(@c1, r3)
  setrow(@d1, r4)
  setrow(@e1, r5)
  setrow(@f1, r6)
  setrow(@g1, r7)
  setrow(@h1, r8)
  setrow(@i1, r9)

  // Initialise row bit patterns
  rowabits := a1+a2+a3+a4+a5+a6+a7+a8+a9
  rowbbits := b1+b2+b3+b4+b5+b6+b7+b8+b9
  rowcbits := c1+c2+c3+c4+c5+c6+c7+c8+c9
  rowdbits := d1+d2+d3+d4+d5+d6+d7+d8+d9
}

```

```

rowebits := e1+e2+e3+e4+e5+e6+e7+e8+e9
rowfbits := f1+f2+f3+f4+f5+f6+f7+f8+f9
rowgbits := g1+g2+g3+g4+g5+g6+g7+g8+g9
rowhbits := h1+h2+h3+h4+h5+h6+h7+h8+h9
rowibits := i1+i2+i3+i4+i5+i6+i7+i8+i9

// Initialise column bit patterns
col1bits := a1+b1+c1+d1+e1+f1+g1+h1+i1
col2bits := a2+b2+c2+d2+e2+f2+g2+h2+i2
col3bits := a3+b3+c3+d3+e3+f3+g3+h3+i3
col4bits := a4+b4+c4+d4+e4+f4+g4+h4+i4
col5bits := a5+b5+c5+d5+e5+f5+g5+h5+i5
col6bits := a6+b6+c6+d6+e6+f6+g6+h6+i6
col7bits := a7+b7+c7+d7+e7+f7+g7+h7+i7
col8bits := a8+b8+c8+d8+e8+f8+g8+h8+i8
col9bits := a9+b9+c9+d9+e9+f9+g9+h9+i9

// Initialise the 3x3 square bit patterns
squ1bits := a1+a2+a3 + b1+b2+b3 + c1+c2+c3
squ2bits := a4+a5+a6 + b4+b5+b6 + c4+c5+c6
squ3bits := a7+a8+a9 + b7+b8+b9 + c7+c8+c9
squ4bits := d1+d2+d3 + e1+e2+e3 + f1+f2+f3
squ5bits := d4+d5+d6 + e4+e5+e6 + f4+f5+f6
squ6bits := d7+d8+d9 + e7+e8+e9 + f7+f8+f9
squ7bits := g1+g2+g3 + h1+h2+h3 + i1+i2+i3
squ8bits := g4+g5+g6 + h4+h5+h6 + i4+i5+i6
squ9bits := g7+g8+g9 + h7+h8+h9 + i7+i8+i9
}

AND try(p, f, rptr, cptr, sptr) BE TEST !p
THEN f() // The cell pointed to by p is already set
        // so move on to the next cell, if any.
ELSE { LET r, c, s = !rptr, !cptr, !sptr
        // r, c and s are bit patterns indicating which digits
        // already occupy the current row, column or square.
        LET poss = All - (r | c | s)
        // poss is a bit pattern indicating which digits can
        // be placed in the current cell.
        WHILE poss DO
        { // Try each allowable digit in turn.
          LET bit = poss & -poss
          poss := poss-bit
          // Update the cell, row, column and square bit patterns.
          !p, !rptr, !cptr, !sptr := bit, r+bit, c+bit, s+bit
          // Move on to the next cell, if any.
        }
      }

```

```

    f()
  }
  // Restore the cell, row, column and square bit patterns.
  !p, !rptr, !cptr, !sptr := 0, r, c, s
}

// The following 81 functions try all possible settings for
// each cell on the board.
AND ta1() BE try(@a1, ta2, @rowabits, @col1bits, @squ1bits)
AND ta2() BE try(@a2, ta3, @rowabits, @col2bits, @squ1bits)
AND ta3() BE try(@a3, ta4, @rowabits, @col3bits, @squ1bits)
AND ta4() BE try(@a4, ta5, @rowabits, @col4bits, @squ2bits)
AND ta5() BE try(@a5, ta6, @rowabits, @col5bits, @squ2bits)
AND ta6() BE try(@a6, ta7, @rowabits, @col6bits, @squ2bits)
AND ta7() BE try(@a7, ta8, @rowabits, @col7bits, @squ3bits)
AND ta8() BE try(@a8, ta9, @rowabits, @col8bits, @squ3bits)
AND ta9() BE try(@a9, tb1, @rowabits, @col9bits, @squ3bits)

AND tb1() BE try(@b1, tb2, @rowbbits, @col1bits, @squ1bits)
AND tb2() BE try(@b2, tb3, @rowbbits, @col2bits, @squ1bits)
AND tb3() BE try(@b3, tb4, @rowbbits, @col3bits, @squ1bits)
AND tb4() BE try(@b4, tb5, @rowbbits, @col4bits, @squ2bits)
AND tb5() BE try(@b5, tb6, @rowbbits, @col5bits, @squ2bits)
AND tb6() BE try(@b6, tb7, @rowbbits, @col6bits, @squ2bits)
AND tb7() BE try(@b7, tb8, @rowbbits, @col7bits, @squ3bits)
AND tb8() BE try(@b8, tb9, @rowbbits, @col8bits, @squ3bits)
AND tb9() BE try(@b9, tc1, @rowbbits, @col9bits, @squ3bits)

AND tc1() BE try(@c1, tc2, @rowcbits, @col1bits, @squ1bits)
AND tc2() BE try(@c2, tc3, @rowcbits, @col2bits, @squ1bits)
AND tc3() BE try(@c3, tc4, @rowcbits, @col3bits, @squ1bits)
AND tc4() BE try(@c4, tc5, @rowcbits, @col4bits, @squ2bits)
AND tc5() BE try(@c5, tc6, @rowcbits, @col5bits, @squ2bits)
AND tc6() BE try(@c6, tc7, @rowcbits, @col6bits, @squ2bits)
AND tc7() BE try(@c7, tc8, @rowcbits, @col7bits, @squ3bits)
AND tc8() BE try(@c8, tc9, @rowcbits, @col8bits, @squ3bits)
AND tc9() BE try(@c9, td1, @rowcbits, @col9bits, @squ3bits)

AND td1() BE try(@d1, td2, @rowdbits, @col1bits, @squ4bits)
AND td2() BE try(@d2, td3, @rowdbits, @col2bits, @squ4bits)
AND td3() BE try(@d3, td4, @rowdbits, @col3bits, @squ4bits)
AND td4() BE try(@d4, td5, @rowdbits, @col4bits, @squ5bits)
AND td5() BE try(@d5, td6, @rowdbits, @col5bits, @squ5bits)
AND td6() BE try(@d6, td7, @rowdbits, @col6bits, @squ5bits)
AND td7() BE try(@d7, td8, @rowdbits, @col7bits, @squ6bits)

```

```

AND td8() BE try(@d8, td9, @rowdbits, @col8bits, @squ6bits)
AND td9() BE try(@d9, te1, @rowdbits, @col9bits, @squ6bits)

AND te1() BE try(@e1, te2, @rowebits, @col1bits, @squ4bits)
AND te2() BE try(@e2, te3, @rowebits, @col2bits, @squ4bits)
AND te3() BE try(@e3, te4, @rowebits, @col3bits, @squ4bits)
AND te4() BE try(@e4, te5, @rowebits, @col4bits, @squ5bits)
AND te5() BE try(@e5, te6, @rowebits, @col5bits, @squ5bits)
AND te6() BE try(@e6, te7, @rowebits, @col6bits, @squ5bits)
AND te7() BE try(@e7, te8, @rowebits, @col7bits, @squ6bits)
AND te8() BE try(@e8, te9, @rowebits, @col8bits, @squ6bits)
AND te9() BE try(@e9, tf1, @rowebits, @col9bits, @squ6bits)

AND tf1() BE try(@f1, tf2, @rowfbits, @col1bits, @squ4bits)
AND tf2() BE try(@f2, tf3, @rowfbits, @col2bits, @squ4bits)
AND tf3() BE try(@f3, tf4, @rowfbits, @col3bits, @squ4bits)
AND tf4() BE try(@f4, tf5, @rowfbits, @col4bits, @squ5bits)
AND tf5() BE try(@f5, tf6, @rowfbits, @col5bits, @squ5bits)
AND tf6() BE try(@f6, tf7, @rowfbits, @col6bits, @squ5bits)
AND tf7() BE try(@f7, tf8, @rowfbits, @col7bits, @squ6bits)
AND tf8() BE try(@f8, tf9, @rowfbits, @col8bits, @squ6bits)
AND tf9() BE try(@f9, tg1, @rowfbits, @col9bits, @squ6bits)

AND tg1() BE try(@g1, tg2, @rowgbits, @col1bits, @squ7bits)
AND tg2() BE try(@g2, tg3, @rowgbits, @col2bits, @squ7bits)
AND tg3() BE try(@g3, tg4, @rowgbits, @col3bits, @squ7bits)
AND tg4() BE try(@g4, tg5, @rowgbits, @col4bits, @squ8bits)
AND tg5() BE try(@g5, tg6, @rowgbits, @col5bits, @squ8bits)
AND tg6() BE try(@g6, tg7, @rowgbits, @col6bits, @squ8bits)
AND tg7() BE try(@g7, tg8, @rowgbits, @col7bits, @squ9bits)
AND tg8() BE try(@g8, tg9, @rowgbits, @col8bits, @squ9bits)
AND tg9() BE try(@g9, th1, @rowgbits, @col9bits, @squ9bits)

AND th1() BE try(@h1, th2, @rowhbits, @col1bits, @squ7bits)
AND th2() BE try(@h2, th3, @rowhbits, @col2bits, @squ7bits)
AND th3() BE try(@h3, th4, @rowhbits, @col3bits, @squ7bits)
AND th4() BE try(@h4, th5, @rowhbits, @col4bits, @squ8bits)
AND th5() BE try(@h5, th6, @rowhbits, @col5bits, @squ8bits)
AND th6() BE try(@h6, th7, @rowhbits, @col6bits, @squ8bits)
AND th7() BE try(@h7, th8, @rowhbits, @col7bits, @squ9bits)
AND th8() BE try(@h8, th9, @rowhbits, @col8bits, @squ9bits)
AND th9() BE try(@h9, ti1, @rowhbits, @col9bits, @squ9bits)

AND ti1() BE try(@i1, ti2, @rowibits, @col1bits, @squ7bits)
AND ti2() BE try(@i2, ti3, @rowibits, @col2bits, @squ7bits)

```

```

AND ti3() BE try(@i3, ti4, @rowibits, @col3bits, @squ7bits)
AND ti4() BE try(@i4, ti5, @rowibits, @col4bits, @squ8bits)
AND ti5() BE try(@i5, ti6, @rowibits, @col5bits, @squ8bits)
AND ti6() BE try(@i6, ti7, @rowibits, @col6bits, @squ8bits)
AND ti7() BE try(@i7, ti8, @rowibits, @col7bits, @squ9bits)
AND ti8() BE try(@i8, ti9, @rowibits, @col8bits, @squ9bits)
AND ti9() BE try(@i9, suc, @rowibits, @col9bits, @squ9bits)

// suc is only called when a solution has been found.
AND suc() BE
{ count := count + 1
  writef("nSolution number %n*n", count)
  prboard()
}

AND c(n) = VALOF SWITCHON n INTO
{ DEFAULT:    RESULTIS '?'
  CASE 0:     RESULTIS '-'
  CASE N1:    RESULTIS '1'
  CASE N2:    RESULTIS '2'
  CASE N3:    RESULTIS '3'
  CASE N4:    RESULTIS '4'
  CASE N5:    RESULTIS '5'
  CASE N6:    RESULTIS '6'
  CASE N7:    RESULTIS '7'
  CASE N8:    RESULTIS '8'
  CASE N9:    RESULTIS '9'
}

AND prboard() BE
{ LET form = "%c %c %c  %c %c %c  %c %c %c*n"
  newline()
  writef(form, c(a1),c(a2),c(a3),c(a4),c(a5),c(a6),c(a7),c(a8),c(a9))
  writef(form, c(b1),c(b2),c(b3),c(b4),c(b5),c(b6),c(b7),c(b8),c(b9))
  writef(form, c(c1),c(c2),c(c3),c(c4),c(c5),c(c6),c(c7),c(c8),c(c9))
  newline()
  writef(form, c(d1),c(d2),c(d3),c(d4),c(d5),c(d6),c(d7),c(d8),c(d9))
  writef(form, c(e1),c(e2),c(e3),c(e4),c(e5),c(e6),c(e7),c(e8),c(e9))
  writef(form, c(f1),c(f2),c(f3),c(f4),c(f5),c(f6),c(f7),c(f8),c(f9))
  newline()
  writef(form, c(g1),c(g2),c(g3),c(g4),c(g5),c(g6),c(g7),c(g8),c(g9))
  writef(form, c(h1),c(h2),c(h3),c(h4),c(h5),c(h6),c(h7),c(h8),c(h9))
  writef(form, c(i1),c(i2),c(i3),c(i4),c(i5),c(i6),c(i7),c(i8),c(i9))

  newline()

```

}

4.26 The Sliding Blocks Puzzle

This section describes a program that explores the structure of the sliding blocks puzzle pictured below.



As can be seen, the puzzle is played on a 4x5 board on which 10 blocks can slide. There are four unit 1x1 blocks (U), four 1x2 blocks (V) oriented vertically, one 2x1 block (H) oriented horizontally and one 2x2 block (S). The initial position of the blocks is as in the picture and the aim is to slide the pieces until the 2x2 block is centred at the bottom. This takes a minimum of 84 moves, where a move is defined to be moving one block by one position up, down, left or right by one place. When the program is run it tells us there are 65880 different placements of the ten pieces of which only 25955 are reachable from the initial position.

The collection of nodes reachable from a given node is called, by mathematicians, a simply connected component, and it turns out that the sliding block puzzle has 898 of them, the largest and smallest having 25955 and 2 nodes, respectively. As we have seen, one of the components of size 25955 nodes includes the starting position.

The structure of the puzzle can be thought of as a graph with each board position represented by a node having edges to other nodes reachable by single moves. The graph is said to be undirected since every move is reversible.

Since there are only 65880 nodes in the graph the program can build the entire graph in memory and then explore it to discover its properties. As a by-product it outputs a minimum length sequence of moves to solve the puzzle.

The board is represented by a 20 bit pattern with each bit indicating the occupancy of each square on the board. The vector `bitsS` holds bit patterns representing the 12 possible placements of the 2x2 block in `bitsS!1` to `bitsS!12`. The upper bound, 12, is held in `bitsS!0`.

A particular placement of the 2x2 block is represented by a placement number `p` in the range 1 to 12. The corresponding bit pattern is thus `bitsS!p`. Its immediately adjacent placement positions are held in the vector `succsS!p`. If we call this vector `v`, then `v!0=n` is the number adjacent placements and `v!1` to `v!n` are their placement numbers.

The vectors `bitsV`, `bitsH` and `bitsU` hold, respectively, the bit patterns representing the 16 possible placements of a vertically oriented 1x2 block, the 15 possible placements of the horizontally oriented 2x1 block, and the 20 possible placements of a 1x1 block. The vectors `succsV`, `succsH` and `succsU` contain adjacency information for these blocks in a form similar to `succsS`.

The program starts as follows.

```
GET "libhdr"

MANIFEST {
  // Selectors for a placement node
  s_link=0      // link=0 or link -> another node at the dist value.
  s_dist        // dist=-1 or the distance from the starting position.
                // If dist=-1, this node has not yet been visited.
  s_prev        // prev=0 or prev -> predecessor node in the path
                // from the starting position to this node.
  s_chain        // chain=0 or chain -> another node with the same hash value.
  s_succs       // List of adjacent placement nodes.

                // succs=0 or succs -> [next, node]
  // Piece placement numbers
  s_S           // The 2x2 block
  s_Va; s_Vb; s_Vc; s_Vd // The four 1x2 blocks
  s_H           // The 2x1 block
  s_Ua; s_Ub; s_Uc; s_Ud // The four 1x1 blocks

  // Board placement bit patterns
  s_S1 // Positions occupied by the 2x2 piece
  s_V4 // Positions occupied by the 1x2 vertical pieces
  s_H1 // Positions occupied by the 2x1 horizontal piece
  s_U4 // Positions occupied by the 1x1 pieces
}
```

```

    s_upb=s_U4 // The upb of a placement node
}

```

These **MANIFEST** constants define the fields of a placement node. The **link** field is used to link all nodes at the same distance from the starting node. This distance is held in the **dist** field with the convention that the starting node is at distance zero. The vector **listv** holds these lists with **listv!d** being the list of all nodes at distance **d**. The **dist** field is set to **-1** in all nodes that have not yet been visited.

The program creates nodes all 65880 valid board placements and puts pointers to them in elements **nodev!1** to **nodev!65880**. The upper bound, 65880, is placed in **nodev!0**. The fields **S1**, **V4**, **H1** and **U4** hold bit patterns representing the placements of the 2x2 block, the 2x1 blocks, the 1x2 block and the 1x1 blocks. These four bit patterns uniquely represent each possible placement of the ten blocks. The placement numbers of the ten blocks are held in the **S**, **Va**, **Vb**, **Vc**, **Vd**, **H**, **Ua**, **Ub**, **Uc** and **Ud** fields.

A hash table, **hashtab**, allows efficient looking up of a placement node given its **S1**, **V4**, **H1** and **U4** settings. The call **hashfn(S1,V4,H1,U4)** computes the hash value. The pointer to the next node in a hash chain is held in the **chain** field.

All the placement nodes are created by the call **createnodes()**. The program then creates, for each placement node, the list of immediately adjacent placements. This list is held in the **succs** field. These lists are created by the call **createsuccs()** which makes calls of the form **mksuccs(node)** for every node in **nodev**.

The program next creates lists of nodes at different distances from the starting position. As we have seen, these lists are placed in the vector **listv**. They are created by the call **createlists()**. The call **find(#x66000,#x09999,#x00006,#00660)** finds the starting node, which is given a **dist** value of zero and becomes the only node in **listv!0**. All other nodes initially have **dist** values of **-1**, indicating that their distances are not yet known. The list of nodes at distance **d** from the starting position is constructed by the call **createlist(d)** which inspects every node in **listv!(d-1)**. Each successor to these nodes, that have not be visited previously, is inserted into **listv!d**, with its **dist** field set to **d** and its **prev** field set to the immediate predecessor. The variable **solution** points to the first node visited that has the 2x2 block placed centrally at the bottom. This combined with the **prev** field values allows the solution to be output. If **listv!d** turns out to be empty, all reachable nodes have been visited and **createlists** returns.

The program shows that a solution can be found in 84 moves and that of the 25955 reachable board positions there are four that are most distant from the initial position taking 133 moves to reach. These positions are:

```

-----
| UUU | UUU | VVV | UUU |           |         | VVV | VVV | UUU |
| UUU | UUU | VVV | UUU |           |         | VVV | VVV | UUU |
|-----+-----| VVV |-----|     |-----+ VVV | VVV |-----|
| VVV | VVV | VVV |         |         | UUU | VVV | VVV |         |
| VVV | VVV | VVV |         |         | UUU | VVV | VVV |         |
| VVV | VVV |-----|         |         |-----+-----+-----|
| VVV | VVV | HHHHHHHHH |         |         | UUU | VVV | HHHHHHHHH |
| VVV | VVV | HHHHHHHHH |         |         | UUU | VVV | HHHHHHHHH |
|-----+-----+-----|         |         |-----+ VVV |-----|
| UUU | VVV | SSSSSSSSS |         |         | VVV | VVV | SSSSSSSSS |
| UUU | VVV | SSSSSSSSS |         |         | VVV | VVV | SSSSSSSSS |
|-----| VVV | SSSSSSSSS |         |         | VVV |-----| SSSSSSSSS |
|         | VVV | SSSSSSSSS |         |         | VVV | UUU | SSSSSSSSS |
|         | VVV | SSSSSSSSS |         |         | VVV | UUU | SSSSSSSSS |
-----

```

and their mirror images. No reachable position has the horizontal block in the top row.

While there are still unvisited nodes, the program goes on to find another component using any unvisited node as the starting node and calling `createlists` again.

The program continues as follows declaring the global variables and some more constants used in the program.

```

GLOBAL {
  bitsS:ug; succsS
  bitsH;    succsH
  bitsV;    succsV
  bitsU;    succsU

  spacev; spacep; spacet
  mkvec
  mk2

  tracing
  nodev
  nodecount
  edgecount
  listv
  hashtab
  root
  componentcount
  componentsize
  componentsizemax

```

```

componentsizein
componentp
solution

hashfn
find
initpieces
createnodes
createsuccs
mksuccs
explore
prboard
prsol
}

MANIFEST {
  Spaceupb   = 2_000_000
  nodevupb   =      65880
  listvupb   =      200
  hashtabsz  =      5000
}

```

The definition of `start` is as follows.

```

LET start() = VALOF
{ LET argv   = VEC 50
  LET stdout = output()
  LET out     = stdout

  UNLESS rdargs("-o/k,-t/s", argv, 50) DO
  { writef("Bad arguments for blocks*n")
    RESULTIS 20
  }

  IF argv!0 DO // -o/k
  { out := findoutput(argv!0)
    UNLESS out DO
    { writef("Unable to open output file %s*n", argv!0)
      RESULTIS 20
    }
    selectoutput(out)
  }

  tracing := argv!1 // -t/s
  solution := 0
}

```

```

nodecount      := 0
edgecount      := 0
componentcount := 0
componentsize  := 0
componentsizemax := 0
componentsizemin := maxint
componenttp    := 0

spacev := getvec(Spaceupb)
spacep, spacet := spacev, spacev+Spaceupb

UNLESS spacev DO
{ writef("Insufficient space available*n")
  RESULTIS 20
}

hashtab := mkvec(hashtabsize-1)
FOR i = 0 TO hashtabsize-1 DO hashtab!i := 0
nodev   := mkvec(nodevupb)
listv   := mkvec(listvupb)
nodecount := 0
solution := 0
root := 0

initpieces()
createnodes() // Create all 65880 placement nodes
createsucss() // Create the successor list for each node

IF FALSE DO
FOR i = 1 TO nodev!0 DO
{ LET node = nodev!i
  LET succs = s_succs!node
  writef("node %i7: ", i)
  prboard(s_S1!node, s_V4!node, s_H1!node, s_U4!node)
  //writef("*nsucss: ")
  //WHILE succs DO
  //{ writef(" %i5", succs!1)
  // succs := succs!0
  //}
  newline()
  succs := s_succs!node
  WHILE succs DO
  { LET succ = succs!1
    writef("succ %i7: ", succ)
    prboard(s_S1!succ, s_V4!succ, s_H1!succ, s_U4!succ)
  }
}

```

```

        newline()
        succs := succs!0
    }
    //abort(1000)
}

explore()

// Lists of nodes at all distances have now been created
// so output the solution

IF solution DO prsol(solution)

writef("nodecount=      %n*n",  nodecount)
writef("edgecount=      %n*n",  edgecount)
writef("componentcount=  %n*n",  componentcount)
writef("componentsizemax=%n*n",  componentsizemax)
writef("componentsizemin=%n*n",  componentsizemin)
writef("space used = %n words*n", spacep-spacev)

fin:
    UNLESS out=stdout DO endwrite()
    freevec(spacev)
    RESULTIS 0
}

```

The program continues as follows.

```

AND mkvec(upb) = VALOF
{ LET p = spacep
  spacep := spacep+upb+1
  IF spacep>spacet DO
  { writef("Insufficient space*n")
    abort(999)
    RESULTIS 0
  }
  //writef("mkvec(%n) => %n*n", upb, p)
  RESULTIS p
}

AND mk2(a, b) = VALOF
{ LET p = mkvec(1)
  p!0, p!1 := a, b
  RESULTIS p
}

```

The program continues as follows.

```

AND mkinitvec(n, a, b, c, d) = VALOF
{ LET p = spacep
  spacep := spacep+n+1
  IF spacep>spacet DO
  { writef("Insufficient space*n")
    abort(999)
    RESULTIS 0
  }
  FOR i = 0 TO n DO p!i := (@n)!i
  RESULTIS p
}

AND initpieces() BE
{ // 2x2 square block
  bitsS := TABLE 12, // placement bits
          #xCC000,    #x66000,    #x33000,    // 1 2 3
          #x0CC00,    #x06600,    #x03300,    // 4 5 6
          #x00CC0,    #x00660,    #x00330,    // 7 8 9
          #x000CC,    #x00066,    #x00033    // 10 11 12

  succsS := mkvec(12)
  succsS! 0 := 12
  succsS! 1 := mkinitvec(2,      2,  4)
  succsS! 2 := mkinitvec(3,      1,  3, 5)
  succsS! 3 := mkinitvec(2,      2,      6)
  succsS! 4 := mkinitvec(3,  1,      5, 7)
  succsS! 5 := mkinitvec(4,  2,  4,  6, 8)
  succsS! 6 := mkinitvec(3,  3,  5,      9)
  succsS! 7 := mkinitvec(3,  4,      8, 10)
  succsS! 8 := mkinitvec(4,  5,  7,  9, 11)
  succsS! 9 := mkinitvec(3,  6,  8,      12)
  succsS!10 := mkinitvec(2,  7,      11  )
  succsS!11 := mkinitvec(3,  8, 10, 12  )
  succsS!12 := mkinitvec(2,  9, 11  )

  // 1x2 vertical block
  bitsV := TABLE 16, // placement bits
          #x88000,    #x44000,    #x22000,    #x11000, // 1 2 3 4
          #x08800,    #x04400,    #x02200,    #x01100, // 5 6 7 8
          #x00880,    #x00440,    #x00220,    #x00110, // 9 10 11 12
          #x00088,    #x00044,    #x00022,    #x00011 // 13 14 15 16

  succsV := mkvec(16)
  succsV! 0 := 16
  succsV! 1 := mkinitvec(2,      2,  5)

```



```

succsV! 2 := mkinitvec(3,      1,  3,  6)
succsV! 3 := mkinitvec(3,      2,  4,  7)
succsV! 4 := mkinitvec(2,      3,      8)
succsV! 5 := mkinitvec(3,  1,      6,  9)
succsV! 6 := mkinitvec(4,  2,  5,  7, 10)
succsV! 7 := mkinitvec(4,  3,  6,  8, 11)
succsV! 8 := mkinitvec(3,  4,  7,      12)
succsV! 9 := mkinitvec(3,  5,      10, 13)
succsV!10 := mkinitvec(4,  6,  9, 11, 14)
succsV!11 := mkinitvec(4,  7, 10, 12, 15)
succsV!12 := mkinitvec(3,  8, 11,      16)
succsV!13 := mkinitvec(2,  9,      14  )
succsV!14 := mkinitvec(3, 10, 13, 15  )
succsV!15 := mkinitvec(3, 11, 14, 16  )
succsV!16 := mkinitvec(2, 12, 15      )

// 2x1 horizontal block
bitsH := TABLE 15, // placement bits
        #xC0000,    #x60000,    #x30000,    //  1  2  3
        #x0C000,    #x06000,    #x03000,    //  4  5  6
        #x00C00,    #x00600,    #x00300,    //  7  8  9
        #x000C0,    #x00060,    #x00030,    // 10 11 12
        #x0000C,    #x00006,    #x00003    // 13 14 15

succsH := mkvec(15)
succsH! 0 := 15
succsH! 1 := mkinitvec(2,      2,  4)
succsH! 2 := mkinitvec(3,      1,  3,  5)
succsH! 3 := mkinitvec(2,      2,      6)
succsH! 4 := mkinitvec(3,  1,      5,  7)
succsH! 5 := mkinitvec(4,  2,  4,  6,  8)
succsH! 6 := mkinitvec(3,  3,  5,      9)
succsH! 7 := mkinitvec(3,  4,      8, 10)
succsH! 8 := mkinitvec(4,  5,  7,  9, 11)
succsH! 9 := mkinitvec(3,  6,  8,      12)
succsH!10 := mkinitvec(3,  7,      11, 13)
succsH!11 := mkinitvec(4,  8, 10, 12, 14)
succsH!12 := mkinitvec(3,  9, 11,      15)
succsH!13 := mkinitvec(2, 10, 14      )
succsH!14 := mkinitvec(3, 11, 13, 15  )
succsH!15 := mkinitvec(2, 12, 14      )

// 1x1 unit squares
bitsU := TABLE 20, // placement bits
        #x80000,    #x40000,    #x20000,    #x10000, //  1  2  3  4

```

```

#x08000,    #x04000,    #x02000,    #x01000,    // 5 6 7 8
#x00800,    #x00400,    #x00200,    #x00100,    // 9 10 11 12
#x00080,    #x00040,    #x00020,    #x00010,    // 13 14 15 16
#x00008,    #x00004,    #x00002,    #x00001     // 17 18 19 20

```

```

succsU := mkvec(20)
succsU! 0 := 20
succsU! 1 := mkinitvec(2,      2, 5)
succsU! 2 := mkinitvec(3,      1, 3, 6)
succsU! 3 := mkinitvec(3,      2, 4, 7)
succsU! 4 := mkinitvec(2,      3, 8)
succsU! 5 := mkinitvec(3, 1,      6, 9)
succsU! 6 := mkinitvec(4, 2, 5, 7, 10)
succsU! 7 := mkinitvec(4, 3, 6, 8, 11)
succsU! 8 := mkinitvec(3, 4, 7, 12)
succsU! 9 := mkinitvec(3, 5, 10, 13)
succsU!10 := mkinitvec(4, 6, 9, 11, 14)
succsU!11 := mkinitvec(4, 7, 10, 12, 15)
succsU!12 := mkinitvec(3, 8, 11, 16)
succsU!13 := mkinitvec(3, 9, 14, 17)
succsU!14 := mkinitvec(4, 10, 13, 15, 18)
succsU!15 := mkinitvec(4, 11, 14, 16, 19)
succsU!16 := mkinitvec(3, 12, 15, 20)
succsU!17 := mkinitvec(2, 13, 18  )
succsU!18 := mkinitvec(3, 14, 17, 19  )
succsU!19 := mkinitvec(3, 15, 18, 20  )
succsU!20 := mkinitvec(2, 16, 19  )
}

```

The program continues as follows.

```

AND addnode(s, va,vb,vc,vd, h, ua,ub,uc,ud) BE
{ // Insert a new placement node in nodev
  LET node = mkvec(s_upb)
  LET S1   = bitsS!s
  LET V4   = bitsV!va + bitsV!vb + bitsV!vc + bitsV!vd
  LET H1   = bitsH!h
  LET U4   = bitsU!ua + bitsU!ub + bitsU!uc + bitsU!ud
  LET hashval = hashfn(S1, V4, H1, U4)
  s_link!node := 0
  s_dist!node := -1
  s_prev!node := 0
  s_chain!node := hashtab!hashval
  hashtab!hashval := node
  s_succs!node := 0
}

```

```

s_S !node := s
s_Va!node := va
s_Vb!node := vb
s_Vc!node := vc
s_Vd!node := vd
s_H !node := h
s_Ua!node := ua
s_Ub!node := ub
s_Uc!node := uc
s_Ud!node := ud

s_S1!node := S1
s_H1!node := H1
s_V4!node := V4
s_U4!node := U4

nodecount := nodecount+1

IF nodecount > nodevupb DO
{ writef("nodevupb=%n is too small for nodecount=%n*n", nodevupb)
  RETURN
}

nodev!nodecount := node
nodev!0 := nodecount
}

```

The program continues as follows.

```

AND hashfn(S1, V4, H, U4) = (S1 XOR V4*5 XOR H*7 XOR U4*11) MOD hashtabsize

AND find(S1, V4, H1, U4) = VALOF
{ LET hashval = hashfn(S1, V4, H1, U4)
  LET node = hashtab!hashval
//writef("find: entered, hashval=%n*n", hashval)
  WHILE node DO
  { IF S1=s_S1!node &
    V4=s_V4!node &
    H1=s_H1!node &
    U4=s_U4!node RESULTIS node
    node := s_chain!node
  }
  writef("find: Failed to find "); prboard(S1,V4,H1,U4)
  newline()
}

```

```

    abort(999)
    RESULTIS 0
}

```

The program continues as follows.

```

AND createnodes() BE
{ FOR s = 1 TO bitsS!0 DO
  { LET bits = bitsS!s
    FOR va = 1 TO bitsV!0 - 3 IF (bits & bitsV!va)=0 DO
      { bits := bits + bitsV!va
        FOR vb = va+1 TO bitsV!0 - 2 IF (bits & bitsV!vb)=0 DO
          { bits := bits + bitsV!vb
            FOR vc = vb+1 TO bitsV!0 - 1 IF (bits & bitsV!vc)=0 DO
              { bits := bits + bitsV!vc
                FOR vd = vc+1 TO bitsV!0 IF (bits & bitsV!vd)=0 DO
                  { bits := bits + bitsV!vd
                    FOR h = 1 TO bitsH!0 IF (bits & bitsH!h)=0 DO
                      { bits := bits + bitsH!h
                        FOR ua = 1 TO bitsU!0 - 3 IF (bits & bitsU!ua)=0 DO
                          { bits := bits + bitsU!ua
                            FOR ub = ua+1 TO bitsU!0 - 2 IF (bits & bitsU!ub)=0 DO
                              { bits := bits + bitsU!ub
                                FOR uc = ub+1 TO bitsU!0 - 1 IF (bits & bitsU!uc)=0 DO
                                  { bits := bits + bitsU!uc
                                    FOR ud = uc+1 TO bitsU!0 IF (bits & bitsU!ud)=0 DO
                                      { bits := bits + bitsU!ud
                                        addnode(s,va,vb,vc,vd,h,ua,ub,uc,ud)
                                        bits := bits - bitsU!ud
                                      }
                                    bits := bits - bitsU!uc
                                  }
                                bits := bits - bitsU!ub
                              }
                            bits := bits - bitsU!ua
                          }
                        bits := bits - bitsH!h
                      }
                    bits := bits - bitsV!vd
                  }
                bits := bits - bitsV!vc
              }
            bits := bits - bitsV!vb
          }
        bits := bits - bitsV!va
      }
    }
  }
}

```

```

    }
  }
}

```

The program continues as follows.

```

AND createsuccs() BE
{ // Create the successor list for every node
  FOR i = 1 TO nodev!0 DO mksuccs(nodev!i)
}

AND mksuccs(node) BE
{ LET all = s_S1!node + s_V4!node + s_H1!node + s_U4!node
  //writef("mksuccs: node is ")
  //prboard(s_S1!node, s_V4!node, s_H1!node, s_U4!node)
  //newline()
  //abort(2000)
  mksuccsS(node, all, s_S !node)
  mksuccsV(node, all, s_Va!node)
  mksuccsV(node, all, s_Vb!node)
  mksuccsV(node, all, s_Vc!node)
  mksuccsV(node, all, s_Vd!node)
  mksuccsH(node, all, s_H !node)
  mksuccsU(node, all, s_Ua!node)
  mksuccsU(node, all, s_Ub!node)
  mksuccsU(node, all, s_Uc!node)
  mksuccsU(node, all, s_Ud!node)
  //abort(2003)
}

AND mksuccsS(p, all, q) BE
{ // all is a bit pattern giving all occupied squares
  // q is the current placement number of the 2x2 S piece
  LET succsv = succsS!q // Vector of successors of placement q
  LET bitsq = bitsS!q // The bit pattern for placement q
  LET bits = all - bitsq // all with placement q removed
  FOR i = 1 TO succsv!0 DO
  { LET j = succsv!i // An adjacent placement of the 2x2 S piece
    LET bitsj = bitsS!j // The bit pattern for placement j
    //writef("mksuccsS: q=%n i=%n j=%n bits=%x5 bitsq=%x5 bitsj=%x5*n",
    // q, i, j, bits, bitsq, bitsj)
    //abort(2001)
    IF (bits & bitsj) = 0 DO
    { // Found a successor
      LET S1, V4, H1, U4 = bitsj, s_V4!p, s_H1!p, s_U4!p
    }
  }
}

```

```

    LET succ = find(S1,V4,H1,U4)
    s_succs!p := mk2(s_succs!p, succ)
    edgcount := edgcount+1
    //writef("S successor ")
    //prboard(S1,V4,H1,U4)
    //newline()
    //abort(1000)
  }
}

AND mksuccsV(p, all, q) BE
{ // all is a bit pattern giving all occupied squares
  // q is the current placement number of a 1x2 V piece
  LET succsv = succsv!q // Vector of successors of placement q
  LET bitsq = bitsV!q // The bit pattern for placement q
  LET bits = all - bitsq // all with placement q removed
  FOR i = 1 TO succsv!0 DO
  { LET j = succsv!i // An adjacent placement of the 1x2 V piece
    LET bitsj = bitsV!j // The bit pattern for placement j
    //writef("mksuccsV: q=%n i=%n j=%n bits=%x5 bitsq=%x5 bitsj=%x5*n",
    // q, i, j, bits, bitsq, bitsj)
    //abort(2001)
    IF (bits & bitsj) = 0 DO
    { // Found a successor
      LET S1, V4, H1, U4 = s_S1!p, s_V4!p-bitsq+bitsj, s_H1!p, s_U4!p
      LET succ = find(S1,V4,H1,U4)
      s_succs!p := mk2(s_succs!p, succ)
      edgcount := edgcount+1
      //writef("V successor ")
      //prboard(S1,V4,H1,U4)
      //newline()
      //abort(1000)
    }
  }
}

AND mksuccsH(p, all, q) BE
{ // all is a bit pattern giving all occupied squares
  // q is the current placement number of the 2x1 H piece
  LET succsv = succsv!q // Vector of successors of placement q
  LET bitsq = bitsH!q // The bit pattern for placement q
  LET bits = all - bitsq // all with placement q removed
  FOR i = 1 TO succsv!0 DO
  { LET j = succsv!i // An adjacent placement of the 2x1 H piece

```

```

LET bitsj = bitsH!j // The bit pattern for placement j
//writef("mksuccsH: q=%n i=%n j=%n bits=%x5 bitsq=%x5 bitsj=%x5*n",
//      q, i, j, bits, bitsq, bitsj)
//abort(2001)
IF (bits & bitsj) = 0 DO
{ // Found a successor
  LET S1, V4, H1, U4 = s_S1!p, s_V4!p, bitsj, s_U4!p
  LET succ = find(S1,V4,H1,U4)
  s_succs!p := mk2(s_succs!p, succ)
  edgecount := edgecount+1
  //writef("H successor ")
  //prboard(S1,V4,H1,U4)
  //newline()
  //abort(1000)
}
}
}

AND mksuccsU(p, all, q) BE
{ // all is a bit pattern giving all occupied squares
  // q is the current placement number of a 1x1 U piece
  LET succsv = succsU!q // Vector of successors of placement q
  LET bitsq = bitsU!q // The bit pattern for placement q
  LET bits = all - bitsq // all with placement q removed
  FOR i = 1 TO succsv!0 DO
  { LET j = succsv!i // An adjacent placement of a 1x1 U piece
    LET bitsj = bitsU!j // The bit pattern for placement j
    //writef("mksuccsU: q=%n i=%n j=%n bits=%x5 bitsq=%x5 bitsj=%x5*n",
    //      q, i, j, bits, bitsq, bitsj)
    //abort(2001)
    IF (bits & bitsj) = 0 DO
    { // Found a successor
      LET S1, V4, H1, U4 = s_S1!p, s_V4!p, s_H1!p, s_U4!p-bitsq+bitsj
      LET succ = find(S1,V4,H1,U4)
      s_succs!p := mk2(s_succs!p, succ)
      edgecount := edgecount+1
      //writef("U successor ")
      //prboard(S1,V4,H1,U4)
      //newline()
      //abort(1000)
    }
  }
}
}
}

```

The program continues as follows.

```

AND explore() BE
{ componentp := 1
  componentcount := 0
  componentsizemax := 0
  componentsizemin := maxint

  // Find the starting position
  root := find(#x66000, #x09999, #x00006, #x00660)

  WHILE root DO
  { LET dist = ?

    // Insert the root of the next simply connected component
    s_link!root, s_dist!root := 0, 0
    listv!0 := root
    dist := 0
    componentcount := componentcount + 1
    componentsize := 1

    WHILE listv!dist DO
    { dist := dist+1
      createlist(dist)
    }

    // The component is now complete
    IF componentsize > componentsizemax DO componentsizemax := componentsize
    IF componentsize < componentsizemin DO componentsizemin := componentsize

    IF tracing DO
    { writef("Component %i3 size %i5 root ", componentcount, componentsize)
      prboard(s_S1!root, s_V4!root, s_H1!root, s_U4!root)
      newline()
      //abort(1007)
    }

    // Find the root of the next component
    root := 0
    WHILE componentp <= nodevupb DO
    { LET node = nodev!componentp
      //writef("componentp = %i5*n", componentp)
      IF s_dist!node < 0 DO
      { root := node
        //writef("new component root = %i5*n", root)
      }
    }
  }
//abort(1008)
  BREAK

```



```

    }
    componentp := componentp + 1
  }
}
}

```

The program continues as follows.

```

AND createlist(dist) BE
{ LET prevnode = listv!(dist-1) // List of nodes at distance dist
  //writef("Making list of nodes at distance %n*n", dist)
  //writef("prevnode=%n*n", prevnode)
  //abort(1006)

  // Create list of nodes at the new distance.
  // The list is initially empty.
  listv!dist := 0

  // Inspect every node at distance dist-1
  WHILE prevnode DO
  { // prevnode is a node at the previous distance.
    // Any successors of prevnode that have not yet been
    // visited are to be inserted into listv!dist.
    LET succs = s_succs!prevnode // List of nodes adjacent to prevnode

    //writef("exploring successors of ")
    //prboard(s_S1!prevnode, s_V4!prevnode, s_H!prevnode, s_U4!prevnode)
    //newline()

    WHILE succs DO
    { LET succ = succs!1 // succ is a successor to prevnode
      IF s_dist!succ < 0 DO
      { // succ has not yet been visited
        s_dist!succ := dist
        s_prev!succ := prevnode
        s_link!succ := listv!dist
        listv!dist := succ
        componentsize := componentsize + 1
        //writef("dist=%i4 ", dist)
        //prboard(s_S1!succ, s_V4!succ, s_H1!succ, s_U4!succ)
        //newline()
        UNLESS solution IF s_S1!succ=#x00066 DO
        { solution := succ
          //writef("Solution*n")
          //abort(1111)
        }
      }
    }
  }
}

```

```

    }
    //abort(3000)
  }
  succs := succs!0
}
prevnode := s_link!prevnode
}
}

```

The program continues as follows.

```

AND prboard(S1, V4, H1, U4) BE
{ LET bit = #x80000

  WHILE bit DO
  { LET ch = '**'
    UNLESS (S1 & bit) = 0 DO ch := 'S'
    UNLESS (H1 & bit) = 0 DO ch := 'H'
    UNLESS (V4 & bit) = 0 DO ch := 'V'
    UNLESS (U4 & bit) = 0 DO ch := 'U'
    writef(" %c", ch)
    IF (bit & #x11110) > 0 DO writef(" ")
    bit := bit>>1
  }
}

AND prsol(node) BE
{ LET S1 = s_S1!node
  LET V4 = s_V4!node
  LET H1 = s_H1!node
  LET U4 = s_U4!node

  IF s_prev!node DO prsol(s_prev!node)

  writef("%i3: ", s_dist!node)
  prboard(S1, V4, H1, U4)

  IF S1=#x00066 DO writes(" solution")
  newline()
}

```

When this program runs it outputs the following.

```

0: * S S *   V S S V   V U U V   V U U V   V H H V
1: V S S *   V S S V   * U U V   V U U V   V H H V

```

```

2:  V S S *   V S S V   V U U V   V U U V   * H H V
3:  V S S *   V S S V   V U U V   V U U V   H H * V
4:  V S S V   V S S V   V U U *   V U U V   H H * V
5:  V S S V   V S S V   V U U *   V U * V   H H U V
6:  V S S V   V S S V   V U * U   V U * V   H H U V
7:  V S S V   V S S V   V U * U   V * U V   H H U V
8:  V S S V   V S S V   V * U U   V * U V   H H U V
9:  V S S V   V S S V   * V U U   * V U V   H H U V
10: * S S V   V S S V   V V U U   * V U V   H H U V
11: * S S V   * S S V   V V U U   V V U V   H H U V
12: S S * V   S S * V   V V U U   V V U V   H H U V
13: S S * V   S S U V   V V * U   V V U V   H H U V
14: S S U V   S S * V   V V * U   V V U V   H H U V
15: S S U V   S S * V   V V U U   V V * V   H H U V
16: S S U V   S S U V   V V * U   V V * V   H H U V
17: S S U V   S S U V   V V U *   V V * V   H H U V
18: S S U V   S S U V   V V U *   V V U V   H H * V
19: S S U V   S S U V   V V U V   V V U V   H H * *
20: S S U V   S S U V   V V U V   V V U V   * H H *
21: S S U V   S S U V   V V U V   V V U V   * * H H
22: S S U V   S S U V   V * U V   V V U V   * V H H
23: S S U V   S S U V   * * U V   V V U V   V V H H
24: * * U V   S S U V   S S U V   V V U V   V V H H
25: * U * V   S S U V   S S U V   V V U V   V V H H
26: U * * V   S S U V   S S U V   V V U V   V V H H
27: U * U V   S S * V   S S U V   V V U V   V V H H
28: U U * V   S S * V   S S U V   V V U V   V V H H
29: U U * V   S S U V   S S * V   V V U V   V V H H
30: U U U V   S S * V   S S * V   V V U V   V V H H
31: U U U V   * S S V   * S S V   V V U V   V V H H
32: U U U V   * S S V   V S S V   V V U V   * V H H
33: U U U V   V S S V   V S S V   * V U V   * V H H
34: U U U V   V S S V   V S S V   V * U V   V * H H
35: U U U V   V S S V   V S S V   V U * V   V * H H
36: U U U V   V S S V   V S S V   V * * V   V U H H
37: U U U V   V * * V   V S S V   V S S V   V U H H
38: U * U V   V U * V   V S S V   V S S V   V U H H
39: U U * V   V U * V   V S S V   V S S V   V U H H
40: U U V *   V U V *   V S S V   V S S V   V U H H
41: U U V *   V U V V   V S S V   V S S *   V U H H
42: U U V V   V U V V   V S S *   V S S *   V U H H
43: U U V V   V U V V   V * S S   V * S S   V U H H
44: U U V V   V * V V   V U S S   V * S S   V U H H
45: U * V V   V U V V   V U S S   V * S S   V U H H
46: * U V V   V U V V   V U S S   V * S S   V U H H

```

```

47: V U V V V U V V * U S S V * S S V U H H
48: V U V V V U V V V U S S V * S S * U H H
49: V U V V V U V V V * S S V U S S * U H H
50: V U V V V U V V V * S S V U S S U * H H
51: V U V V V U V V V * S S V * S S U U H H
52: V U V V V U V V V S S * V S S * U U H H
53: V U V * V U V V V S S V V S S * U U H H
54: V U V * V U V * V S S V V S S V U U H H
55: V U * V V U * V V S S V V S S V U U H H
56: V * U V V U * V V S S V V S S V U U H H
57: V * U V V * U V V S S V V S S V U U H H
58: * V U V * V U V V S S V V S S V U U H H
59: * V U V V V U V V S S V * S S V U U H H
60: V V U V V V U V * S S V * S S V U U H H
61: V V U V V V U V S S * V S S * V U U H H
62: V V U V V V * V S S U V S S * V U U H H
63: V V * V V V U V S S U V S S * V U U H H
64: V V * V V V U V S S * V S S U V U U H H
65: V V * V V V * V S S U V S S U V U U H H
66: V V V * V V V * S S U V S S U V U U H H
67: V V V * V V V V S S U V S S U * U U H H
68: V V V V V V V V S S U * S S U * U U H H
69: V V V V V V V V S S * U S S U * U U H H
70: V V V V V V V V S S U U S S * * U U H H
71: V V V V V V V V S S U U S S H H U U * *
72: V V V V V V V V S S U U S S H H U * U *
73: V V V V V V V V S S U U S S H H * U U *
74: V V V V V V V V S S U U S S H H * U * U
75: V V V V V V V V S S U U S S H H * * U U
76: V V V V V V V V * * U U S S H H S S U U
77: V V V V V V V V * U * U S S H H S S U U
78: V V V V V V V V U * * U S S H H S S U U
79: V V V V V V V V U * U * S S H H S S U U
80: V V V V V V V V U U * * S S H H S S U U
81: V V V V V V V V U U H H S S * * S S U U
82: V V V V V V V V U U H H S S U * S S * U
83: V V V V V V V V U U H H S S * U S S * U
84: V V V V V V V V U U H H * S S U * S S U solution
nodecount=      65880
edgecount=      206780
componentcount=  898
componentsizemax=25955
componentsizemin=2
space used = 1736680 words

```

4.27 The Rubik Cube

The popular Rubik Cube puzzle, pictured below, has much in common with the sliding blocks puzzle described above. From any position, you can make a small number of moves to reach adjacent positions. Unfortunately there are 43,252,003,274,489,856,000 possible positions (see rubik cube on the web) making it impossible to represent the entire graph in memory.

Much more to follow

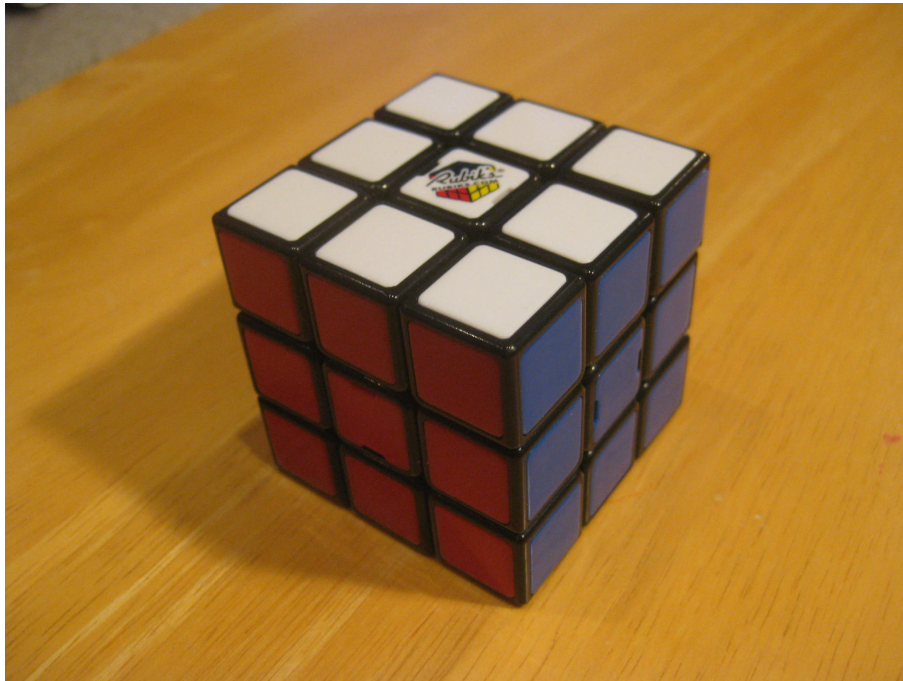

My aim was to construct a program to solve the rubik cube starting at any random position without resorting to one of the recipies available on the web. I have so far failed and am unlikely to attempt to improve the program, so here is the current draft (called `rubik.b`). Even if you choose not to study this program in detail, you might like to look at the function `findnode` since it shows how hash tables can be implemented. Ffloyd's algorithm might also be of interest (see the function `ffloyd`). Information about this algorithm is easily availble on the web. Do a web search on `ffloyds algorithm`.

```
/*
##### UNDER DEVEOPMENT #####
```

This program is unlikely to ever be finished, but may be of interest all the same.

This is a second attempt to write a program to solve the rubik cube. The first attempt (in `rubik1.b`) used a strategy that was too

slow to be useful unless the solution has a rather small number of moves.

This program attempts to solve Rubik Cube problems, given a textual specification of an initial position, it will hopefully output a sequence of rotations to solve the cube.

Implemented by Martin Richards (c) January 2015

This program uses a lot of work space so it is a good idea to run cintsys with a large memory size. You can, for instance, run the system with 100 million words of Cintcode memory by executing the following shell command.

```
cintsys -m 100000000
```

This program is still too slow to find solutions in general, but seems to get quite close. For instance, output generated by the command

```
rubik -s 4
```

ends as follows:

```
new bestscore=434 nodecount=4491837
```

```

      W W W
      W W W
      W W W
G G G  R R R  B B B  O O O
G G G  R R R  B B O  B O O
G Y G  R O R  B B B  O G O
      Y Y Y
      R Y Y
      Y Y Y
```

Insufficient space

```
nodecount = 8259446
space used: 75000002 out of 75000000
360.630>
```

So it found that partial solution after visiting fewer than 5 million nodes. Note that only a few pieces are not in their correct positions.
*/

```
GET "libhdr"
```

```

MANIFEST {
  // This program assumes the cube is always in the same orientation
  // with upper face being white and the front face red.
  // The other faces are
  //   right  blue
  //   back   orange
  //   left   green
  //   down   yellow

  // Corner piece definitions
  // orientation 0 means W/Y piece face is parallel to up face
  //               1 means the piece was rotated anticlockwise once
  //               when looking towards its corner.
  //               2 means the piece was rotated anticlockwise twice
  WRB0=0*3+0; WRB1=0*3+1; WRB2=0*3+2 // Corner 0
  WBO0=1*3+0; WBO1=1*3+1; WBO2=1*3+2 // Corner 1
  WOG0=2*3+0; WOG1=2*3+1; WOG2=2*3+2 // Corner 2
  WGR0=3*3+0; WGR1=3*3+1; WGR2=3*3+2 // Corner 3

  YBR0=4*3+0; YBR1=4*3+1; YBR2=4*3+2 // Corner 4
  YOB0=5*3+0; YOB1=5*3+1; YOB2=5*3+2 // Corner 5
  YGO0=6*3+0; YGO1=6*3+1; YGO2=6*3+2 // Corner 6
  YRG0=7*3+0; YRG1=7*3+1; YRG2=7*3+2 // Corner 7

  corncostvupb = YRG2
  corncostvsize = corncostvupb+1 // Number of elements in a row or column
  corncostmupb = corncostvsize*corncostvsize-1 // Upb of the matrix

  // There are 12 Edge pieces
  // The edge directions are
  //   0->1  1->2  2->3  3->0
  //   0->4  1->5  2->6  3->7
  //   4->7  5->4  6->5  7->6
  // orientation 0 means the first colour is on the left when
  //                   looking forward along the edge
  // orientation 1 means the first colour is on the right when
  //                   looking forward along the edge

  // Upper level edges
  WR0= 0*2+0; WR1= 0*2+1 // in edge  0->1
  WB0= 1*2+0; WB1= 1*2+1 // in edge  1->2
  WO0= 2*2+0; WO1= 2*2+1 // in edge  2->3
  WG0= 3*2+0; WG1= 3*2+1 // in edge  3->0

  // Middle layer edges

```

```

BR0= 4*2+0; BR1= 4*2+1 // in edge 0->4
OB0= 5*2+0; OB1= 5*2+1 // in edge 1->5
GO0= 6*2+0; GO1= 6*2+1 // in edge 2->6
RG0= 7*2+0; RG1= 7*2+1 // in edge 3->7

// Down layer edges
YR0= 8*2+0; YR1= 8*2+1 // in edge 4->7
YB0= 9*2+0; YB1= 9*2+1 // in edge 5->4
Y00=10*2+0; Y01=10*2+1 // in edge 6->5
YG0=11*2+0; YG1=11*2+1 // in edge 7->6

edgcostvupb = YG1
edgcostvsize = edgcostvupb+1 // Number of elements in a row or column
edgcostmupb = edgcostvsize*edgcostvsize-1 // Upb of the matrix

// 8 Corner positions used in the cost function
cWRB=0; cWBO; cWOG; cWGR // White corners
cYBR; cYOB; cYGO; cYRG // Yellow corners

// 12 Edge positions used in the cost function
eWR=0; eWB; eWO; eWG
eBR; eOB; eGO; eRG
eYR; eYB; eYO; eYG

// 8 Corner byte position indexes on the cube
iWRB=0; iWBO; iWOG; iWGR // White corners
iYBR; iYOB; iYGO; iYRG // Yellow corners

// 12 Edge byte position indexes on the cube
iWR; iWB; iWO; iWG
iBR; iOB; iGO; iRG
iYR; iYB; iYO; iYG

s_chain= iYG / bytesperword + 1 // Hash chain field
s_prev // Immediate predecessor
s_move // The move from predecessor to this node
s_maxdepth // This node has been or is being searched
// with this setting of maxdepth

nodeupb = s_maxdepth

// Moves for Upper, Front, Right, Back, Left and Down
// c = clockwise
// a = anti clockwise
// These are used to record the sequence of moves
mUc='U'; mUa='u'
```



```

mFc='F'; mFa='f'
mRc='R'; mRa='r'
mBc='B'; mBa='b'
mLc='L'; mLa='l'
mDc='D'; mDa='d'
}

GLOBAL {
// 8 Corner positions on the p cube as global variables
pWRB:ug; pWBO; pWOG; pWGR // White corners
pYBR; pYOB; pYGO; pYRG // Yellow corners
pWR; pWB; pWO; pWG // 12 Edge positions on the p cube
pBR; pOB; pGO; pRG
pYR; pYB; pYO; pYG

// 8 Corner positions on the q cube as global variables
qWRB; qWBO; qWOG; qWGR // White corners
qYBR; qYOB; qYGO; qYRG // Yellow corners
qWR; qWB; qWO; qWG // 12 Edge positions on the q cube
qBR; qOB; qGO; qRG
qYR; qYB; qYO; qYG

corncostm
corncostv
// corncostm is a 24x24 matrix giving the cost of moving a
// piece from one corner of the cube to another changing its
// orientation at the same time. If i and j are row and
// column subscripts of corncostm then they have the form
// corner*3+orientaion where corner is the corner number
// in the range 0 to 7 and oritation is the orientation
// number in the range 0 to 2.
// corncostv!i is a vector corresponding to the ith row
// of matrix corncostm. So the (i,j)th element of the matrix
// can be accessed by corncostv!i!j. To see how it is used
// see the function corncost.

edgcostm
edgcostv
// edgcostm is a 24x24 matrix giving the cost of moving a
// piece from one edge postion to another possibly flipping
// its orientation. Its structure is similar to cordcostm.
// The ((i,j)th element of edgcostm can be accessed by
// edgcost!i!j. See the function edgcost.

fin_p; fin_l

```

```

spacev; spacep; spacet
spacevupb
hashtabsize
hashtabupb
mkvec
nodecount
hashtab
hashfn
findnode      // Find a node in the hash table, creating one
               // if necessary.

cube          // A packed cube -- 20 bytes = 5 words
colour       // colour!0 .. colour!53
errors       // =TRUE if an error has occurred
moves        // Initialising moves supplied by -m argument
bestnode
bestscore
initcostfn
costfn
score        // (node) returns the node's score
scorenode
exploreroot
exploretree
try
prnode
tracing
compact      // =TRUE for compact configuration output
randomise    // Set by the -r or -s options
pieces2cube
cube2pieces
rotc
rota
flip
rotateUc; rotateUa
rotateDc; rotateDa
rotateFc; rotateFa
rotateBc; rotateBa
rotateRc; rotateRa
rotateLc; rotateLa

movecubep2q; movecubeq2p
cornrotate;  edgerotate
ffloyd
prcornmat; predgemat

```

```

prmoves
corncost; edgcost
prcosts
prcorncost; predgcost
prsolution
wrcornerpiece; wredgpiece
prpieces
prnode; prnode
setface
corner; edge
cols2cube; cube2cols
setcornercols; setedgcols
}

LET hashfn(node) = VALOF
{ // Return a hash value in range 0 to hashtabupb
  LET w = node!0 XOR node!1 XOR node!2 XOR node!3 XOR node!4
  LET h = w MOD hashtabsize
  UNLESS 0 <= h <= hashtabupb DO
  { prnode(node)
    writef("%x8 %x8 %x8 %x8 %x8*n",
           node!0, node!1, node!2, node!3, node!4)
    writef("w = %x8 => hashval = %n*n", w, h)
    abort(999)
  }
  RESULTIS h
}

AND findnode(cube, prev, move) = VALOF
{ // Find the node that matches the configuration in cube
  // prev=0 or is the immediate predecessor
  // move=0 or is the move to reach this node
  // These values are only used if the node has not been seen before.
  // It creates a new node if necessary.
  LET hashval = hashfn(cube)
  LET node = hashtab!hashval
  //writef("hashval=%n node=%n*n", hashval, node)
  WHILE node DO
  { IF cube!0=node!0 &
    cube!1=node!1 &
    cube!2=node!2 &
    cube!3=node!3 &
    cube!4=node!4 DO
  { //writef("node %n has been seen before*n", node)
    RESULTIS node // The node already exists
  }
  }
}

```

```

    }
    node := s_chain!node
  }
//writef("Matching node not found so create one*n")

// The matching node has not been found so create one.

node := mkvec(nodeupb)
UNLESS node DO
{ writef("Node space needed*n")
  stop(0, 0) //abort(999)
  RESULTIS 0
}
// Fill in all its fields
node!0 := cube!0 // The corners
node!1 := cube!1
node!2 := cube!2 // The edges
node!3 := cube!3
node!4 := cube!4

// Fill in its remaining fields
s_prev!node := prev
s_move!node := move
s_maxdepth!node := 0

// Insert it into its hash chain
s_chain!node := hashtable!hashval
hashtable!hashval := node

nodecount := nodecount+1

IF tracing DO
{ writef("New node %n, nodecount=%n*n",
        node, nodecount)
  prnode(node)
}

RESULTIS node
}

AND mkvec(upb) = VALOF
{ LET p = spacep
  spacep := spacep+upb+1
  IF spacep>spacet DO
  { writef("Insufficient space*n")

```

```

    longjump(fin_p, fin_l) //abort(999)
    RESULTIS 0
}
RESULTIS p
}

LET start() = VALOF
{ LET argv = VEC 50
  LET root = 0

  fin_p := level()
  fin_l := fin

  // Allocate 75% of current Cintcode memory as work space.
  // All other space used by this program is taken out of
  // this allocation.
  spacevupb := rootnode!rtn_memsize*3/4
  hashtabsize := spacevupb/113
  hashtabupb := hashtabsize-1
  writef("%nAllocating %n words of work space, hashtabupb=%n*n",
        spacevupb, hashtabupb)

  spacev := getvec(spacevupb)

  spacep, spacet := spacev, spacev+spacevupb

  UNLESS spacev DO
  { writef("Insufficient space available, cannot allocate spacev*n")
    GOTO fin
  }

  cube := mkvec(nodeupb) // Structure representing the current state of the cube
  colour := mkvec(6*9-1)
  corncostm := mkvec(corncostmupb)
  corncostv := mkvec(corncostvupb)
  edgecostm := mkvec(edgecostmupb)
  edgecostv := mkvec(edgecostvupb)

  UNLESS cube & colour &
        corncostm & edgecostm &
        corncostv & edgecostv DO
  { writef("Insufficient space available*n")
    GOTO fin
  }
}

```

```

errors := FALSE

UNLESS rdargs("W,R,B,O,G,Y,-m/K,-s/K/N,-r/S,-t/S,-c/S", argv, 50) DO
{ writef("Bad arguments for Rubik*n")
  GOTO fin
}

// Set default colours of the solved cube
FOR i = 0 TO 8 DO colour!i := 'W'
FOR i = 9 TO 17 DO colour!i := 'R'
FOR i = 18 TO 26 DO colour!i := 'B'
FOR i = 27 TO 35 DO colour!i := 'O'
FOR i = 36 TO 44 DO colour!i := 'G'
FOR i = 45 TO 53 DO colour!i := 'Y'

// Set user specified colours
IF argv!0 DO setface(0, 'W', argv!0) // W
IF argv!1 DO setface(1, 'R', argv!1) // R
IF argv!2 DO setface(2, 'B', argv!2) // B
IF argv!3 DO setface(3, 'O', argv!3) // O
IF argv!4 DO setface(4, 'G', argv!4) // G
IF argv!5 DO setface(5, 'Y', argv!5) // Y

moves := argv!6 // -m/K

randomise := FALSE

IF argv!7 DO // -s/K/N
{ //writef("calling setseed(%n)*n", !(argv!7))
  setseed(!(argv!7))
  randomise := TRUE
}

IF argv!8 DO // -r/S
{ LET day, msecs, filler = 0, 0, 0
  datstamp(@day)
  randomise := TRUE
  setseed(msecs) // Set seed based on time of day
}

tracing := argv!9 // -t/S
compact := argv!10 // -c/S

cols2cube(colour, cube)
cube2pieces(cube, @pWRB)

// Make initial moves, if any

```

```

IF moves FOR i = 1 TO moves%0 DO
{ SWITCHON moves%i INTO
  { DEFAULT: writef("Bad initial moves %s*n", moves)
    errors := TRUE
    BREAK

    CASE 'U': rotateUc(); ENDCASE
    CASE 'u': rotateUa(); ENDCASE
    CASE 'F': rotateFc(); ENDCASE
    CASE 'f': rotateFa(); ENDCASE
    CASE 'R': rotateRc(); ENDCASE
    CASE 'r': rotateRa(); ENDCASE
    CASE 'B': rotateBc(); ENDCASE
    CASE 'b': rotateBa(); ENDCASE
    CASE 'L': rotateLc(); ENDCASE
    CASE 'l': rotateLa(); ENDCASE
    CASE 'D': rotateDc(); ENDCASE
    CASE 'd': rotateDa(); ENDCASE
  }
  movecubeq2p()
}

// Possibly randomise the cube
IF randomise FOR i = 1 TO 200 DO
{ SWITCHON randno(15) INTO
  { DEFAULT: LOOP

    CASE 1: rotateUc(); ENDCASE
    CASE 2: rotateUa(); ENDCASE
    CASE 3: rotateFc(); ENDCASE
    CASE 4: rotateFa(); ENDCASE
    CASE 5: rotateRc(); ENDCASE
    CASE 6: rotateRa(); ENDCASE
    CASE 7: rotateBc(); ENDCASE
    CASE 8: rotateBa(); ENDCASE
    CASE 9: rotateLc(); ENDCASE
    CASE 10: rotateLa(); ENDCASE
    CASE 11: rotateDc(); ENDCASE
    CASE 12: rotateDa(); ENDCASE
  }
  movecubeq2p()
}

IF errors RESULTIS 0

```

```

// Pack the starting position in cube
pieces2cube(@pWRB, cube)

newline()
newline()
initcostfn()
//prcosts()

//writef("\n\nThe starting position is:\n\n")
//prpieces(@pWRB); newline()
//movecube2q()
//writef("score = %n\n", score()+goalscore(cube))
//prnode(cube)
//newline()
//abort(1000)

hashtab := mkvec(hashtabupb)
FOR i = 0 TO hashtabupb DO hashtab!i := 0

nodecount := 0

// The starting node configuration is now in cube

//writef("Creating the starting position\n")

// Create a new node with prev=0 and no move
root := findnode(cube, 0, 0, 0)

{ LET bestsc = bestscore
  root := exploreroot(root, 1)
  IF bestscore=0 | bestsc=bestscore BREAK
} REPEAT

writef("\n\nSolution\n\n")
prsolution(root)

fin:
writef("\n\nnodecount = %n\n", nodecount)
writef("space used: %n out of %n\n",
      spacep-spacev, spacet-spacev)

IF spacev DO freevec(spacev)
RESULTIS 0
}

```



```

AND exploreroot(root, maxdepth) = VALOF
{ // root is a new root node from which to start the search
  // to find a nearest node with minimum score no more than
  // maxdepth away. During the search nodes are put into the hash
  // table so that we can easily test whether a node has already
  // been visited.
  // The function returns a node with minimum score.
  // If the best node has the same score as root, exploreroot will
  // have to be called again with a larger maxdepth.

  LET rootscore = scorenode(root)

  // Initialise bestscore and bestnode
  bestscore, bestnode := rootscore, root

  //writef("exploreroot: score=%n  space used = %n*n", rootscore, spacep-spacev)
  //prnode(root)
  IF bestscore=0 RESULTIS root
//abort(5000)

  exploretree(root, maxdepth)

  IF bestscore < rootscore RESULTIS bestnode

  maxdepth := maxdepth + 1
  //writef("bestscore = %n, trying exploreroot with new maxdepth = %n*n",
  //      bestscore, maxdepth)
  //abort(6000)
} REPEAT

AND exploretree(node, maxdepth) BE
{ LET sc = score()+goalscore(node)

  IF sc < bestscore DO
  { bestscore, bestnode := sc, node
    writef("new bestscore=%n nodecount=%n*n", bestscore, nodecount)
    prnode(node)
    //abort(7000)
  }
  //writef("exploretree: maxdepth=%n score=%n bestscore=%n nodecount=%n*n",
  //      maxdepth, sc, bestscore, nodecount)
  //prnode(node)
  //IF sc=0 DO abort(1000)
  IF maxdepth=0 RETURN // We have reached the depth limit

```

```

// Return is this node has already be processed at this maxdepth.
IF s_maxdepth!node >= maxdepth RETURN

// Try the 12 possible successors of this node
// in the list.

try(rotateUc, node, mUc, maxdepth)
try(rotateUa, node, mUa, maxdepth)
try(rotateFc, node, mFc, maxdepth)
try(rotateFa, node, mFa, maxdepth)
try(rotateRc, node, mRc, maxdepth)
try(rotateRa, node, mRa, maxdepth)
try(rotateBc, node, mBc, maxdepth)
try(rotateBa, node, mBa, maxdepth)
try(rotateLc, node, mLc, maxdepth)
try(rotateLa, node, mLa, maxdepth)
try(rotateDc, node, mDc, maxdepth)
try(rotateDa, node, mDa, maxdepth)
}

AND try(rotfn, prev, move, maxdepth) BE IF bestscore DO
{ // Explore an immediate successor of node prev
  LET node = ?
  // First unpack prev in pWRB, etc
  cube2pieces(prev, @pWRB)

  //prpieces(@pWRB)
  rotfn() // q cube := p cube with one face rotated
  //newline()
  //prpieces(@qWRB)
  //abort(1000)
  pieces2cube(@qWRB, cube)
  node := findnode(cube, prev, move)

  exploretree(node, maxdepth-1) // Explore the successor nodes
}

AND pieces2cube(pieces, cube) BE
{ cube%iWRB := pieces!iWRB
  cube%iWBO := pieces!iWBO
  cube%iWOG := pieces!iWOG
  cube%iWGR := pieces!iWGR
  cube%iYBR := pieces!iYBR
  cube%iYOB := pieces!iYOB
  cube%iYGO := pieces!iYGO

```

```

cube%iYRG := pieces%iYRG

cube%iWR := pieces%iWR
cube%iWB := pieces%iWB
cube%iWO := pieces%iWO
cube%iWG := pieces%iWG

cube%iBR := pieces%iBR
cube%iOB := pieces%iOB
cube%iGO := pieces%iGO
cube%iRG := pieces%iRG

cube%iYR := pieces%iYR
cube%iYB := pieces%iYB
cube%iYO := pieces%iYO
cube%iYG := pieces%iYG
}

AND cube2pieces(cube, pieces) BE
{ pieces%iWRB := cube%iWRB
  pieces%iWBO := cube%iWBO
  pieces%iWOG := cube%iWOG
  pieces%iWGR := cube%iWGR
  pieces%iYBR := cube%iYBR
  pieces%iYOB := cube%iYOB
  pieces%iYGO := cube%iYGO
  pieces%iYRG := cube%iYRG

  pieces%iWR := cube%iWR
  pieces%iWB := cube%iWB
  pieces%iWO := cube%iWO
  pieces%iWG := cube%iWG

  pieces%iBR := cube%iBR
  pieces%iOB := cube%iOB
  pieces%iGO := cube%iGO
  pieces%iRG := cube%iRG

  pieces%iYR := cube%iYR
  pieces%iYB := cube%iYB
  pieces%iYO := cube%iYO
  pieces%iYG := cube%iYG
}

AND rotc(piece) = VALOF SWITCHON piece INTO

```

```

{ // Rotate a corner piece one position clockwise
  DEFAULT: writef("rotc: System error, piece=%n*n", piece)
           abort(999)
           RESULTIS piece

  CASE WRB1: CASE WRB2: CASE WBO1: CASE WBO2:
  CASE WOG1: CASE WOG2: CASE WGR1: CASE WGR2:
  CASE YBR1: CASE YBR2: CASE YOB1: CASE YOB2:
  CASE YGO1: CASE YGO2: CASE YRG1: CASE YRG2:
           RESULTIS piece-1

  CASE WRB0: CASE WBO0: CASE WOG0: CASE WGR0:
  CASE YOBO: CASE YBR0: CASE YGO0: CASE YRGO:
           RESULTIS piece+2
}

AND rota(piece) = VALOF SWITCHON piece INTO
{ // Rotate a corner piece one position anti-clockwise
  DEFAULT: writef("rot1: System error, piece=%n*n", piece)
           abort(999)
           RESULTIS piece

  CASE WRB0: CASE WRB1: CASE WBO0: CASE WBO1:
  CASE WOG0: CASE WOG1: CASE WGR0: CASE WGR1:
  CASE YBR0: CASE YBR1: CASE YOBO: CASE YOB1:
  CASE YGO0: CASE YGO1: CASE YRGO: CASE YRG1:
           RESULTIS piece+1

  CASE WRB2: CASE WBO2: CASE WOG2: CASE WGR2:
  CASE YOBO: CASE YBR2: CASE YGO2: CASE YRG2:
           RESULTIS piece-2
}

AND flip(piece) = piece XOR 1 // Flip an edge piece

AND rotateUc() BE
{ // Rotate the upper face clockwise by a quarter turn
  qWRB, qWBO, qWOG, qWGR := pWBO, pWOG, pWGR, pWRB // Rotated
  qYBR, qYOB, qYGO, qYRG := pYBR, pYOB, pYGO, pYRG // Not rotated
  qWR, qWB, qWO, qWG := pWB, pWO, pWG, pWR // Rotated
  qBR, qOB, qGO, qRG := pBR, pOB, pGO, pRG // Not rotated
  qYR, qYB, qYO, qYG := pYR, pYB, pYO, pYG // Not rotated
}

```

```

AND rotateUa() BE
{ // Rotate the upper face anti-clockwise by a quarter turn
  qWRB, qwBO, qwOG, qwGR := pWGR, pWRB, pwBO, pwOG // Rotated
  qYBR, qYOB, qYGO, qYRG := pYBR, pYOB, pYGO, pYRG // Not rotated
  qWR, qwB, qwO, qwG := pWG, pWR, pwB, pwO // Rotated
  qBR, qOB, qGO, qRG := pBR, pOB, pGO, pRG // Not rotated
  qYR, qYB, qYO, qYG := pYR, pYB, pYO, pYG // Not rotated
}

AND rotateDc() BE
{ // Rotate the down face clockwise by a quarter turn
  qWRB, qwBO, qwOG, qwGR := pWRB, pwBO, pwOG, pWGR // Not rotated
  qYBR, qYOB, qYGO, qYRG := pYRG, pYBR, pYOB, pYGO // Rotated
  qWR, qwB, qwO, qwG := pWR, pwB, pwO, pwG // Not rotated
  qBR, qOB, qGO, qRG := pBR, pOB, pGO, pRG // Not rotated
  qYR, qYB, qYO, qYG := pYG, pYR, pYB, pYO // Rotated
}

AND rotateDa() BE
{ // Rotate the down face anti-clockwise by a quarter turn
  qWRB, qwBO, qwOG, qwGR := pWRB, pwBO, pwOG, pWGR // Not rotated
  qYBR, qYOB, qYGO, qYRG := pYOB, pYGO, pYRG, pYBR // Rotated
  qWR, qwB, qwO, qwG := pWR, pwB, pwO, pwG // Not rotated
  qBR, qOB, qGO, qRG := pBR, pOB, pGO, pRG // Not rotated
  qYR, qYB, qYO, qYG := pYB, pYO, pYG, pYR // Rotated
}

AND rotateFc() BE
{ // Rotate the front face clockwise by a quarter turn
  qWRB, qYBR, qYRG, qwGR := rotc(pWGR), rota(pWRB), rotc(pYBR), rota(pYRG) // Rotated
  qwBO, qYOB, qYGO, qwOG := pwBO, pYOB, pYGO, pwOG // Not rotated
  qWR, qBR, qYR, qRG := flip(pRG), pWR, pBR, flip(pYR) // Rotated
  qwB, qYB, qYG, qwG := pwB, pYB, pYG, pwG // Not rotated
  qwO, qOB, qYO, qGO := pwO, pOB, pYO, pGO // Not rotated
}

AND rotateFa() BE
{ // Rotate the front face anti-clockwise by a quarter turn
  qWRB, qYBR, qYRG, qwGR := rotc(pYBR), rota(pYRG), rotc(pWGR), rota(pWRB) // Rotated
  qwBO, qYOB, qYGO, qwOG := pwBO, pYOB, pYGO, pwOG // Not rotated
  qWR, qBR, qYR, qRG := pBR, pYR, flip(pRG), flip(pWR) // Rotated
  qwB, qYB, qYG, qwG := pwB, pYB, pYG, pwG // Not rotated
  qwO, qOB, qYO, qGO := pwO, pOB, pYO, pGO // Not rotated
}

```

```

AND rotateBc() BE
{ // Rotate the back face clockwise by a quarter turn
  qWBO, qWOG, qYGO, qYOB := rota(pYOB), rotc(pWBO), rota(pWOG), rotc(pYGO) // Rotated
  qWRB, qWGR, qYRG, qYBR := pWRB, pWGR, pYRG, pYBR // Not rotated
  qWO, qGO, qYO, qOB := flip(pOB), pWO, pGO, flip(pYO) // Rotated
  qWB, qWG, qYG, qYB := pWB, pWG, pYG, pYB // Not rotated
  qWR, qRG, qYR, qBR := pWR, pRG, pYR, pBR // Not rotated
}

```

```

AND rotateBa() BE
{ // Rotate the back face anti-clockwise by a quarter turn
  qWBO, qWOG, qYGO, qYOB := rota(pWOG), rotc(pYGO), rota(pYOB), rotc(pWBO) // Rotated
  qWRB, qWGR, qYRG, qYBR := pWRB, pWGR, pYRG, pYBR // Not rotated
  qWO, qGO, qYO, qOB := pGO, pYO, flip(pOB), flip(pWO) // Rotated
  qWB, qWG, qYG, qYB := pWB, pWG, pYG, pYB // Not rotated
  qWR, qRG, qYR, qBR := pWR, pRG, pYR, pBR // Not rotated
}

```

```

AND rotateRc() BE
{ // Rotate the right face clockwise by a quarter turn
  qWRB, qWBO, qYOB, qYBR := rota(pYBR), rotc(pWRB), rota(pWBO), rotc(pYOB) // Rotated
  qWGR, qYRG, qYGO, qWOG := pWGR, pYRG, pYGO, pWOG // Not rotated
  qWB, qOB, qYB, qBR := flip(pBR), pWB, pOB, flip(pYB) // Rotated
  qWR, qWO, qYO, qYR := pWR, pWO, pYO, pYR // Not rotated
  qWG, qRG, qYG, qGO := pWG, pRG, pYG, pGO // Not rotated
}

```

```

AND rotateRa() BE
{ // Rotate the right face anti-clockwise by a quarter turn
  qWRB, qWBO, qYOB, qYBR := rota(pWBO), rotc(pYOB), rota(pYBR), rotc(pWRB) // Rotated
  qWGR, qYRG, qYGO, qWOG := pWGR, pYRG, pYGO, pWOG // Not rotated
  qWB, qOB, qYB, qBR := pOB, pYB, flip(pBR), flip(pWB) // Rotated
  qWR, qWO, qYO, qYR := pWR, pWO, pYO, pYR // Not rotated
  qWG, qRG, qYG, qGO := pWG, pRG, pYG, pGO // Not rotated
}

```

```

AND rotateLc() BE
{ // Rotate the left face clockwise by a quarter turn
  qWGR, qYRG, qYGO, qWOG := rotc(pWOG), rota(pWGR), rotc(pYRG), rota(pYGO) // Rotated
  qWBO, qYOB, qYBR, qWRB := pWBO, pYOB, pYBR, pWRB // Not rotated
  qWG, qRG, qYG, qGO := flip(pGO), pWG, pRG, flip(pYG) // Rotated
  qWR, qYR, qYO, qWO := pWR, pYR, pYO, pWO // Not rotated
  qWB, qOB, qYB, qBR := pWB, pOB, pYB, pBR // Not rotated
}

```

```

AND rotateLa() BE
{ // Rotate the left face anti-clockwise by a quarter turn
  qWGR, qYRG, qYGO, qWOG := rotc(pYRG), rota(pYGO), rotc(pWOG), rota(pWGR) // Rotated
  qWBO, qYOB, qYBR, qWRB := pWBO, pYOB, pYBR, pWRB // Not rotated
  qWG, qRG, qYG, qGO := pRG, pYG, flip(pGO), flip(pWG) // Rotated
  qWR, qYR, qYO, qWO := pWR, pYR, pYO, pWO // Not rotated
  qWB, qOB, qYB, qBR := pWB, pOB, pYB, pBR // Not rotated
}

AND movecubep2q() BE
{ qWRB, qWBO, qWOG, qWGR := pWRB, pWBO, pWOG, pWGR
  qYBR, qYOB, qYGO, qYRG := pYBR, pYOB, pYGO, pYRG
  qWR, qWB, qWO, qWG := pWR, pWB, pWO, pWG
  qBR, qOB, qGO, qRG := pBR, pOB, pGO, pRG
  qYR, qYB, qYO, qYG := pYR, pYB, pYO, pYG
}

AND movecubeq2p() BE
{ pWRB, pWBO, pWOG, pWGR := qWRB, qWBO, qWOG, qWGR
  pYBR, pYOB, pYGO, pYRG := qYBR, qYOB, qYGO, qYRG
  pWR, pWB, pWO, pWG := qWR, qWB, qWO, qWG
  pBR, pOB, pGO, pRG := qBR, qOB, qGO, qRG
  pYR, pYB, pYO, pYG := qYR, qYB, qYO, qYG
}

AND initcostfn() BE
{ // Initialise corncostv
  FOR i = 0 TO corncostvupb DO corncostv!i := corncostm + i*corncostvsize
  // Set all elements of corncostm to 10
  FOR i = 0 TO corncostmupb DO
    corncostm!i := 10 // No cost will be as large as 10
  // Set all elements on the leading diagonal to 0
  FOR p = 0 TO corncostvupb DO
    { LET rowp = corncostm + corncostvsize*p
      rowp!p := 0
    }
  // Set a cost of one for every single move
  cornrotate(0, 1, 0, mUa) // Corner 0 moves
  cornrotate(0, 3, 0, mUc)
  cornrotate(0, 3, 1, mFa)
  cornrotate(0, 4, 1, mFc)
  cornrotate(0, 4, 2, mRa)
  cornrotate(0, 1, 2, mRc)

  cornrotate(1, 2, 0, mUa) // Corner 1 moves

```

```
cornrotate(1, 0, 0, mUc)
cornrotate(1, 0, 1, mRa)
cornrotate(1, 5, 1, mRc)
cornrotate(1, 5, 2, mBa)
cornrotate(1, 2, 2, mBc)

cornrotate(2, 3, 0, mUa) // Corner 2 moves
cornrotate(2, 1, 0, mUc)
cornrotate(2, 1, 1, mBa)
cornrotate(2, 6, 1, mBc)
cornrotate(2, 6, 2, mLa)
cornrotate(2, 3, 2, mLc)

cornrotate(3, 0, 0, mUa) // Corner 3 moves
cornrotate(3, 2, 0, mUc)
cornrotate(3, 2, 1, mLa)
cornrotate(3, 7, 1, mLc)
cornrotate(3, 7, 2, mFa)
cornrotate(3, 0, 2, mFc)

cornrotate(4, 7, 0, mDa) // Corner 4 moves
cornrotate(4, 5, 0, mDc)
cornrotate(4, 5, 1, mRa)
cornrotate(4, 0, 1, mRc)
cornrotate(4, 0, 2, mFa)
cornrotate(4, 7, 2, mFc)

cornrotate(5, 4, 0, mDa) // Corner 5 moves
cornrotate(5, 6, 0, mDc)
cornrotate(5, 6, 1, mBa)
cornrotate(5, 1, 1, mBc)
cornrotate(5, 1, 2, mRa)
cornrotate(5, 4, 2, mRc)

cornrotate(6, 5, 0, mDa) // Corner 6 moves
cornrotate(6, 7, 0, mDc)
cornrotate(6, 7, 1, mLa)
cornrotate(6, 2, 1, mLc)
cornrotate(6, 2, 2, mBa)
cornrotate(6, 5, 2, mBc)

cornrotate(7, 6, 0, mDa) // Corner 7 moves
cornrotate(7, 4, 0, mDc)
cornrotate(7, 4, 1, mFa)
cornrotate(7, 3, 1, mFc)
```



```

cornrotate(7, 3, 2, mLa)
cornrotate(7, 6, 2, mLc)

//writef("*ncorner cost matrix before applying Ffloyd's algorithm*n")
//prcornmat(corncostm, corncostvsize)

// Apply Ffloyd's algorithm
ffloyd(corncostm, corncostvsize)

//writef("*ncorner cost matrix after applying Ffloyd's algorithm*n")
//prcornmat(corncostm, corncostvsize)
//abort(2000)

// Initialise edgcostv
FOR i = 0 TO edgcostvupb DO edgcostv!i := edgcostm + i*edgcostvsize
// Set all elements of edgcostm to 10
FOR i = 0 TO edgcostmupb DO
  edgcostm!i := 10 // No cost will be as large as 10
// Set all elements on the leading diagonal to 0
FOR p = 0 TO edgcostvupb DO
{ LET rowp = edgcostm + edgcostvsize*p
  rowp!p := 0
}
// Set a cost of one for every single move
edgerotate( 0,  1, 0, mUa) // Edge 0 moves
edgerotate( 0,  3, 0, mUc)
edgerotate( 0,  7, 1, mFa)
edgerotate( 0,  4, 0, mFc)

edgerotate( 1,  2, 0, mUa) // Edge 1 moves
edgerotate( 1,  0, 0, mUc)
edgerotate( 1,  4, 1, mRa)
edgerotate( 1,  5, 0, mRc)

edgerotate( 2,  3, 0, mUa) // Edge 2 moves
edgerotate( 2,  1, 0, mUc)
edgerotate( 2,  5, 1, mBa)
edgerotate( 2,  6, 0, mBc)

edgerotate( 3,  0, 0, mUa) // Edge 3 moves
edgerotate( 3,  2, 0, mUc)
edgerotate( 3,  6, 1, mLc)
edgerotate( 3,  7, 0, mLc)

```

```

edgerotate( 4,  0, 0, mFa) // Edge 4 moves
edgerotate( 4,  8, 0, mFc)
edgerotate( 4,  9, 1, mRa)
edgerotate( 4,  1, 1, mRc)

edgerotate( 5,  1, 0, mRa) // Edge 5 moves
edgerotate( 5,  9, 0, mRc)
edgerotate( 5, 10, 1, mBa)
edgerotate( 5,  2, 1, mBc)

edgerotate( 6,  2, 0, mBa) // Edge 6 moves
edgerotate( 6, 10, 0, mBc)
edgerotate( 6, 11, 1, mLa)
edgerotate( 6,  3, 1, mLc)

edgerotate( 7,  3, 0, mLa) // Edge 7 moves
edgerotate( 7, 11, 0, mLc)
edgerotate( 7,  8, 1, mFa)
edgerotate( 7,  0, 1, mFc)

edgerotate( 8, 11, 0, mDa) // Edge 8 moves
edgerotate( 8,  9, 0, mDc)
edgerotate( 8,  4, 0, mFa)
edgerotate( 8,  7, 1, mFc)

edgerotate( 9,  8, 0, mDa) // Edge 9 moves
edgerotate( 9, 10, 0, mDc)
edgerotate( 9,  5, 0, mRa)
edgerotate( 9,  4, 1, mRc)

edgerotate(10,  9, 0, mDa) // Edge 10 moves
edgerotate(10, 11, 0, mDc)
edgerotate(10,  6, 0, mBa)
edgerotate(10,  5, 1, mBc)

edgerotate(11, 10, 0, mDa) // Edge 11 moves
edgerotate(11,  8, 0, mDc)
edgerotate(11,  7, 0, mLa)
edgerotate(11,  6, 1, mLc)

//writef("*nedge cost matrix before applying Ffloyd's algorithm*n")
//predgemat(edgecostm, edgecostvsize)

// Apply Ffloyd's algorithm
ffloyd(edgecostm, edgecostvsize)

```

```

//writef("*nedge cost matrix after applying Ffloyd's algorithm*n")
//predgemat(edgecostm, edgecostvsize)
//abort(3000)
}

AND cornrotate(c1, c2, rot, move) BE
{ // rot = 0 no change in orientation,          ie 0->0, 1->1 and 2->2
  // rot = 1 corner piece rotated anti-clockwise, ie 0->1, 1->2 and 2->0
  // rot = 2 corner piece rotated clockwise,     ie 0->2, 1->0 and 2->1
  FOR o1 = 0 TO 2 DO // The three orientations of the piece at corner c1
  { LET o2 = (o1 + rot) MOD 3 // orientation when moved to corner c2
    LET p = c1*3 + o1
    LET rowp = corncostv!p
    LET q = c2*3 + o2
    // A piece at corner c1 with orientation o1 can be moved to
    // corner c2 with orientation o2 by a single move.
    rowp!q := 1
  }
}

AND edgerotate(e1, e2, flip, move) BE
{ // flip = 0 no change in orientation, ie 0->0 and 1->1
  // flip = 1 edge piece flipped,          ie 0->1 and 1->0
  FOR o1 = 0 TO 1 DO // The two orientations of the piece at edge e1
  { LET o2 = o1 XOR flip // orientation when moved to edge e2
    LET p = e1*2 + o1
    LET rowp = edgecostv!p
    LET q = e2*2 + o2
    // A piece at edge e1 with orientation o1 can be moved to
    // edge e2 with orientation o2 by a single move.
    rowp!q := 1
  }
}

AND ffloyd(m, n) BE FOR k = 0 TO n-1 DO
{ LET rowk = m + k*n
  FOR i = 0 TO n-1 DO
  { LET rowi = m + i*n
    LET mik = rowi!k
    FOR j = 0 TO n-1 DO
    { LET mkj = rowk!j
      LET d = mik+mkj
      IF rowi!j > d DO rowi!j := d
    }
  }
}

```

```

}
}

```

```

AND prcornmat(m, n) BE
{ newline()
  FOR i = 0 TO n-1 DO
  { LET rowi = m + i*n
    writef("row %i2:", i)
    FOR j = 0 TO n-1 DO
    { LET d = rowi!j
      TEST d=10 THEN writef(" .")
        ELSE writef(" %n", rowi!j)
      IF j MOD 3 = 2 DO wrch(' ')
    }
    IF i MOD 3 = 2 DO newline()
  }
  newline()
}
}

```

```

AND predgemat(m, n) BE
{ newline()
  FOR i = 0 TO n-1 DO
  { LET rowi = m + i*n
    writef("row %i2:", i)
    FOR j = 0 TO n-1 DO
    { LET d = rowi!j
      TEST d=10 THEN writef(" .")
        ELSE writef(" %n", rowi!j)
      IF j MOD 2 = 1 DO wrch(' ')
    }
    IF i MOD 2 = 1 DO newline()
  }
  newline()
}
}

```

```

AND prmoves(moves) BE IF moves DO
{ prmoves(moves>>8)
  wrch(moves&255)
}

```

```

AND corncost(piece, corner) = VALOF
{ LET d = piece MOD 3
  LET res = corncostv!(piece-d)!(3*corner+d)
  //writef("corner piece = %n/%n corner = %n cost = %n*n",
  //      piece/3, piece MOD 3, corner, res)
}

```

```

    RESULTIS res
  }

  AND edgcost(piece, edge) = VALOF
  { LET res = edgcostv!piece!(2*edge)
    //writef("edge piece = %i2/%n edge = %i2 cost = %n*n",
    //      piece/2, piece MOD 2, edge, res)
    RESULTIS res
  }

  AND costfn() = VALOF
  { // Return the cost of the position in qWRB, etc
    // This is the sum of the minimum number of moves
    // required for each piece.
    LET c = ?
    //writef("costfn: entered*n")
    c :=      corncost(qWRB, cWRB)
    c := c + corncost(qWBO, cWBO)
    c := c + corncost(qWOG, cWOG)
    c := c + corncost(qWGR, cWGR)
    c := c + corncost(qYBR, cYBR)
    c := c + corncost(qYOB, cYOB)
    c := c + corncost(qYGO, cYGO)
    c := c + corncost(qYRG, cYRG)

    c := c + edgcost(qWR, eWR)
    c := c + edgcost(qWB, eWB)
    c := c + edgcost(qWO, eWO)
    c := c + edgcost(qWG, eWG)

    c := c + edgcost(qBR, eBR)
    c := c + edgcost(qOB, eOB)
    c := c + edgcost(qGO, eGO)
    c := c + edgcost(qRG, eRG)

    c := c + edgcost(qYR, eYR)
    c := c + edgcost(qYB, eYB)
    c := c + edgcost(qYO, eYO)
    c := c + edgcost(qYG, eYG)
    //writef("costfn: cost = %n*n", c)
    //abort(4000)

    RESULTIS c * c // Square to discourage pieces many moves
                  // from their required positions.
  }

```

```

AND scorenode(node) = VALOF
{ cube2pieces(node, @qWRB)
  RESULTIS score()+goalscore(node)
}

```

```

AND score() = costfn()

```

```

AND prcosts() BE
{ newline()
  prcorncost("WRB0: ", WRB0)
  prcorncost("WRB1: ", WRB1)
  prcorncost("WRB2: ", WRB2)
  newline()
  prcorncost("WBO0: ", WBO0)
  prcorncost("WBO1: ", WBO1)
  prcorncost("WBO2: ", WBO2)
  newline()
  prcorncost("WOG0: ", WOG0)
  prcorncost("WOG1: ", WOG1)
  prcorncost("WOG2: ", WOG2)
  newline()
  prcorncost("WGR0: ", WGR0)
  prcorncost("WGR1: ", WGR1)
  prcorncost("WGR2: ", WGR2)
  newline()
  prcorncost("YBR0: ", YBR0)
  prcorncost("YBR1: ", YBR1)
  prcorncost("YBR2: ", YBR2)
  newline()
  prcorncost("YOB0: ", YOB0)
  prcorncost("YOB1: ", YOB1)
  prcorncost("YOB2: ", YOB2)
  newline()
  prcorncost("YGO0: ", YGO0)
  prcorncost("YGO1: ", YGO1)
  prcorncost("YGO2: ", YGO2)
  newline()
  prcorncost("YRG0: ", YRG0)
  prcorncost("YRG1: ", YRG1)
  prcorncost("YRG2: ", YRG2)

  newline()

  predgecost("WRO: ", WRO)

```

```

    predgecost("WR1: ", WR1)
    newline()
    predgecost("WB0: ", WB0)
    predgecost("WB1: ", WB1)
    newline()
    predgecost("W00: ", W00)
    predgecost("W01: ", W01)
    newline()
    predgecost("WGO: ", WGO)
    predgecost("WG1: ", WG1)
    newline()

    predgecost("BR0: ", BR0)
    predgecost("BR1: ", BR1)
    newline()
    predgecost("OB0: ", OB0)
    predgecost("OB1: ", OB1)
    newline()
    predgecost("G00: ", G00)
    predgecost("G01: ", G01)
    newline()
    predgecost("RG0: ", RG0)
    predgecost("RG1: ", RG1)
    newline()

    predgecost("YR0: ", YR0)
    predgecost("YR1: ", YR1)
    newline()
    predgecost("YB0: ", YB0)
    predgecost("YB1: ", YB1)
    newline()
    predgecost("Y00: ", Y00)
    predgecost("Y01: ", Y01)
    newline()
    predgecost("YG0: ", YG0)
    predgecost("YG1: ", YG1)
    newline()
}

AND prcorncost(str, piece) BE
{ writef("%s: ", str)
  FOR corner = 0 TO 7 DO writef(" %i3", corncost(piece, corner))
  newline()
}

```

```

AND predgecost(str, piece) BE
{ writef("%s: ", str)
  FOR edge = 0 TO 11 DO writef(" %i3", edgecost(piece, edge))
  newline()
}

```

```

AND prsolution(node) BE
{ IF s_prev!node DO
  { prsolution(s_prev!node)
    writef("move %c*n", s_move!node)
  }
  prcube(node)
}

```

```

AND wrcornerpiece(piece) BE
{ SWITCHON piece/3 INTO
  {
    CASE cWRB: writef(" WRB"); ENDCASE
    CASE cWBO: writef(" WBO"); ENDCASE
    CASE cWOG: writef(" WOG"); ENDCASE
    CASE cWGR: writef(" WGR"); ENDCASE
    CASE cYBR: writef(" YBR"); ENDCASE
    CASE cYOB: writef(" YOB"); ENDCASE
    CASE cYGO: writef(" YGO"); ENDCASE
    CASE cYRG: writef(" YRG"); ENDCASE
  }
  writef("%n", piece MOD 3)
}

```

```

AND wredgepiece(piece) BE
{ SWITCHON piece/2 INTO
  {
    CASE eWR: writef(" WR"); ENDCASE
    CASE eWB: writef(" WB"); ENDCASE
    CASE eWO: writef(" WO"); ENDCASE
    CASE eWG: writef(" WG"); ENDCASE

    CASE eBR: writef(" BR"); ENDCASE
    CASE eOB: writef(" OB"); ENDCASE
    CASE eGO: writef(" GO"); ENDCASE
    CASE eRG: writef(" RG"); ENDCASE

    CASE eYB: writef(" YB"); ENDCASE
    CASE eYO: writef(" YO"); ENDCASE
    CASE eYG: writef(" YG"); ENDCASE
  }
}

```



```

    CASE eYR: writef(" YR"); ENDCASE
  }
  writef("%n ", piece MOD 2)
}

AND prpieces(pieces) BE
{ LET c = VEC 4
  pieces2cube(pieces, c)
  wrcornerpiece(c%0)
  wrcornerpiece(c%1)
  wrcornerpiece(c%2)
  wrcornerpiece(c%3)
  wrcornerpiece(c%4)
  wrcornerpiece(c%5)
  wrcornerpiece(c%6)
  wrcornerpiece(c%7)
  newline()
  wredgepiece(c%8)
  wredgepiece(c%9)
  wredgepiece(c%10)
  wredgepiece(c%11)
  wredgepiece(c%12)
  wredgepiece(c%13)
  wredgepiece(c%14)
  wredgepiece(c%15)
  wredgepiece(c%16)
  wredgepiece(c%17)
  wredgepiece(c%18)
  wredgepiece(c%19)
  newline()
  prcube(c)
}

AND prnode(node) BE
{ //writef("node=%n prev=%n*n",
  //      node, s_prev!node)
  prcube(node)
}

AND prcube(cube) BE
{ /* Typical output is either

  WWWWWWWW GGGGGGGG RRRRRRRR BBBBBBBB OOOOOOOO YYYYYYYY

  or

```

```

        W W W
        W W W
        W W W
    G G G R R R B B B O O O
    G G G R R R B B B O O O
    G G G R R R B B B O O O
        Y Y Y
        Y Y Y
        Y Y Y
*/

cube2cols(cube, colour)

IF compact DO
{ writef("%c%c%c%c%c%c%c%c%c ",          // Upper face
        colour!0, colour!1, colour!2,
        colour!3, colour!4, colour!5,
        colour!6, colour!7, colour!8)
  writef("%c%c%c%c%c%c%c%c%c ",          // Left face
        colour!36, colour!37, colour!38,
        colour!39, colour!40, colour!41,
        colour!42, colour!43, colour!44)
  writef("%c%c%c%c%c%c%c%c%c ",          // Front face
        colour! 9, colour!10, colour!11,
        colour!12, colour!13, colour!14,
        colour!15, colour!16, colour!17)
  writef("%c%c%c%c%c%c%c%c%c ",          // Right face
        colour!18, colour!19, colour!20,
        colour!21, colour!22, colour!23,
        colour!24, colour!25, colour!26)
  writef("%c%c%c%c%c%c%c%c%c ",          // Back face
        colour!27, colour!28, colour!29,
        colour!30, colour!31, colour!32,
        colour!33, colour!34, colour!35)
  writef("%c%c%c%c%c%c%c%c%c*n",        // Down face
        colour!45, colour!46, colour!47,
        colour!48, colour!49, colour!50,
        colour!51, colour!52, colour!53)

  RETURN
}

writef("      %c %c %c*n", colour!0, colour!1, colour!2)
writef("      %c %c %c*n", colour!3, colour!4, colour!5)
writef("      %c %c %c*n", colour!6, colour!7, colour!8)

```

```

writef(" %c %c %c ", colour!36, colour!37, colour!38)
writef(" %c %c %c ", colour! 9, colour!10, colour!11)
writef(" %c %c %c ", colour!18, colour!19, colour!20)
writef(" %c %c %c*n", colour!27, colour!28, colour!29)

writef(" %c %c %c ", colour!39, colour!40, colour!41)
writef(" %c %c %c ", colour!12, colour!13, colour!14)
writef(" %c %c %c ", colour!21, colour!22, colour!23)
writef(" %c %c %c*n", colour!30, colour!31, colour!32)

writef(" %c %c %c ", colour!42, colour!43, colour!44)
writef(" %c %c %c ", colour!15, colour!16, colour!17)
writef(" %c %c %c ", colour!24, colour!25, colour!26)
writef(" %c %c %c*n", colour!33, colour!34, colour!35)

writef("          %c %c %c*n", colour!45, colour!46, colour!47)
writef("          %c %c %c*n", colour!48, colour!49, colour!50)
writef("          %c %c %c*n", colour!51, colour!52, colour!53)

}

AND setface(n, ch, str) BE
{ LET face = @colour!(9*n)
  UNLESS str%0=9 & capitalch(str%5)=ch DO
  { writef("Bad face colours %c %s*n", ch, str)
    errors := TRUE
  }
  FOR i = 1 TO str%0 DO face!(i-1) := capitalch(str%i)
}

AND corner(a, b, c) = VALOF SWITCHON a<<16 | b<<8 | c INTO
{ DEFAULT: writef("*nBad corner: %c%c%c*n", a, b, c)
  errors := TRUE
  RESULTIS 0

CASE 'W'<<16 | 'R'<<8 | 'B': RESULTIS WRB0
CASE 'B'<<16 | 'W'<<8 | 'R': RESULTIS WRB1
CASE 'R'<<16 | 'B'<<8 | 'W': RESULTIS WRB2

CASE 'W'<<16 | 'B'<<8 | 'O': RESULTIS WBO0
CASE 'O'<<16 | 'W'<<8 | 'B': RESULTIS WBO1
CASE 'B'<<16 | 'O'<<8 | 'W': RESULTIS WBO2

CASE 'W'<<16 | 'O'<<8 | 'G': RESULTIS WOGO

```

```

CASE 'G'<<16 | 'W'<<8 | 'O': RESULTIS WOG1
CASE 'O'<<16 | 'G'<<8 | 'W': RESULTIS WOG2

CASE 'W'<<16 | 'G'<<8 | 'R': RESULTIS WGR0
CASE 'R'<<16 | 'W'<<8 | 'G': RESULTIS WGR1
CASE 'G'<<16 | 'R'<<8 | 'W': RESULTIS WGR2

CASE 'Y'<<16 | 'B'<<8 | 'R': RESULTIS YBR0
CASE 'R'<<16 | 'Y'<<8 | 'B': RESULTIS YBR1
CASE 'B'<<16 | 'R'<<8 | 'Y': RESULTIS YBR2

CASE 'Y'<<16 | 'O'<<8 | 'B': RESULTIS YOB0
CASE 'B'<<16 | 'Y'<<8 | 'O': RESULTIS YOB1
CASE 'O'<<16 | 'B'<<8 | 'Y': RESULTIS YOB2

CASE 'Y'<<16 | 'G'<<8 | 'O': RESULTIS YG00
CASE 'O'<<16 | 'Y'<<8 | 'G': RESULTIS YG01
CASE 'G'<<16 | 'O'<<8 | 'Y': RESULTIS YG02

CASE 'Y'<<16 | 'R'<<8 | 'G': RESULTIS YRG0
CASE 'G'<<16 | 'Y'<<8 | 'R': RESULTIS YRG1
CASE 'R'<<16 | 'G'<<8 | 'Y': RESULTIS YRG2
}

AND edge(a, b) = VALOF SWITCHON a<<8 | b INTO
{ DEFAULT: writef("nBad edge: %c%c*n", a, b)
  errors := TRUE
  RESULTIS 0

CASE 'W'<<8 | 'R': RESULTIS WRO
CASE 'R'<<8 | 'W': RESULTIS WR1
CASE 'W'<<8 | 'B': RESULTIS WBO
CASE 'B'<<8 | 'W': RESULTIS WB1
CASE 'W'<<8 | 'O': RESULTIS WOO
CASE 'O'<<8 | 'W': RESULTIS WO1
CASE 'W'<<8 | 'G': RESULTIS WGO
CASE 'G'<<8 | 'W': RESULTIS WG1

CASE 'B'<<8 | 'R': RESULTIS BRO
CASE 'R'<<8 | 'B': RESULTIS BR1
CASE 'O'<<8 | 'B': RESULTIS OBO
CASE 'B'<<8 | 'O': RESULTIS OB1
CASE 'G'<<8 | 'O': RESULTIS GOO
CASE 'O'<<8 | 'G': RESULTIS GO1
CASE 'R'<<8 | 'G': RESULTIS RGO

```

```

CASE 'G'<<8 | 'R': RESULTIS RG1

CASE 'Y'<<8 | 'R': RESULTIS YR0
CASE 'R'<<8 | 'Y': RESULTIS YR1
CASE 'Y'<<8 | 'B': RESULTIS YB0
CASE 'B'<<8 | 'Y': RESULTIS YB1
CASE 'Y'<<8 | 'O': RESULTIS YO0
CASE 'O'<<8 | 'Y': RESULTIS YO1
CASE 'Y'<<8 | 'G': RESULTIS YG0
CASE 'G'<<8 | 'Y': RESULTIS YG1
}

AND cols2cube(cv, cube) BE
{ // Colour coordinates

//          0  1  2
//          3  4  5
//          6  7  8
// 36 37 38   9 10 11  18 19 20  27 28 29
// 39 40 41  12 13 14  21 22 23  30 31 32
// 42 43 44  15 16 17  24 25 26  33 34 35
//          45 46 47
//          48 49 50
//          51 52 53

cube%iWRB := corner(cv! 8, cv!11, cv!18)
cube%iWBO := corner(cv! 2, cv!20, cv!27)
cube%iWOG := corner(cv! 0, cv!29, cv!36)
cube%iWGR := corner(cv! 6, cv!38, cv! 9)
cube%iYBR := corner(cv!47, cv!24, cv!17)
cube%iYOB := corner(cv!53, cv!33, cv!26)
cube%iYGO := corner(cv!51, cv!42, cv!35)
cube%iYRG := corner(cv!45, cv!15, cv!44)

cube%iWR  := edge(cv! 7, cv!10)
cube%iWB  := edge(cv! 5, cv!19)
cube%iWO  := edge(cv! 1, cv!28)
cube%iWG  := edge(cv! 3, cv!37)

cube%iBR  := edge(cv!21, cv!14)
cube%iOB  := edge(cv!30, cv!23)
cube%iGO  := edge(cv!39, cv!32)
cube%iRG  := edge(cv!12, cv!41)

cube%iYR  := edge(cv!46, cv!16)

```

```

cube%iYB := edge(cv!50, cv!25)
cube%iYD := edge(cv!52, cv!34)
cube%iYG := edge(cv!48, cv!43)
}

AND cube2cols(cube, cv) BE
{ // Colour coordinates

//          0  1  2
//          3  4  5
//          6  7  8
// 36 37 38   9 10 11  18 19 20  27 28 29
// 39 40 41  12 13 14  21 22 23  30 31 32
// 42 43 44  15 16 17  24 25 26  33 34 35
//          45 46 47
//          48 49 50
//          51 52 53

cv! 4 := 'W' // Fixed colours
cv!13 := 'R'
cv!22 := 'B'
cv!31 := 'O'
cv!40 := 'G'
cv!49 := 'Y'

setcornercols(cv, cube%iWRB, 8, 11, 18) // Corner pieces
setcornercols(cv, cube%iWB0, 2, 20, 27)
setcornercols(cv, cube%iWOG, 0, 29, 36)
setcornercols(cv, cube%iWGR, 6, 38, 9)
setcornercols(cv, cube%iYBR, 47, 24, 17)
setcornercols(cv, cube%iYOB, 53, 33, 26)
setcornercols(cv, cube%iYGO, 51, 42, 35)
setcornercols(cv, cube%iYRG, 45, 15, 44)

setedgecols(cv, cube%iWR, 7, 10) // edge piece, left sq, right sq
setedgecols(cv, cube%iWB, 5, 19)
setedgecols(cv, cube%iWO, 1, 28)
setedgecols(cv, cube%iWG, 3, 37)

setedgecols(cv, cube%iBR, 21, 14)
setedgecols(cv, cube%iOB, 30, 23)
setedgecols(cv, cube%iGO, 39, 32)
setedgecols(cv, cube%iRG, 12, 41)

setedgecols(cv, cube%iYR, 46, 16)

```

```

    setedgecols(cv, cube%iYB, 50, 25)
    setedgecols(cv, cube%iY0, 52, 34)
    setedgecols(cv, cube%iYG, 48, 43)
}

AND setcornercols(cv, piece, i, j, k) BE
{ // i, j, k are corner face numbers in anti-clockwise order
  //writef("setcornercols %i2 %i2 %i2 %i2*n", piece, i, j, k)
  SWITCHON piece INTO
  { DEDFAULT:      writef("System error in setcornercols: piece=%n*n", piece)

    CASE WRB0:    cv!i, cv!j, cv!k := 'W', 'R', 'B'; RETURN
    CASE WRB1:    cv!j, cv!k, cv!i := 'W', 'R', 'B'; RETURN
    CASE WRB2:    cv!k, cv!i, cv!j := 'W', 'R', 'B'; RETURN
    CASE WBO0:    cv!i, cv!j, cv!k := 'W', 'B', 'O'; RETURN
    CASE WBO1:    cv!j, cv!k, cv!i := 'W', 'B', 'O'; RETURN
    CASE WBO2:    cv!k, cv!i, cv!j := 'W', 'B', 'O'; RETURN
    CASE WOG0:    cv!i, cv!j, cv!k := 'W', 'O', 'G'; RETURN
    CASE WOG1:    cv!j, cv!k, cv!i := 'W', 'O', 'G'; RETURN
    CASE WOG2:    cv!k, cv!i, cv!j := 'W', 'O', 'G'; RETURN
    CASE WGR0:    cv!i, cv!j, cv!k := 'W', 'G', 'R'; RETURN
    CASE WGR1:    cv!j, cv!k, cv!i := 'W', 'G', 'R'; RETURN
    CASE WGR2:    cv!k, cv!i, cv!j := 'W', 'G', 'R'; RETURN

    CASE YBRO:    cv!i, cv!j, cv!k := 'Y', 'B', 'R'; RETURN
    CASE YBR1:    cv!j, cv!k, cv!i := 'Y', 'B', 'R'; RETURN
    CASE YBR2:    cv!k, cv!i, cv!j := 'Y', 'B', 'R'; RETURN
    CASE YOBO:    cv!i, cv!j, cv!k := 'Y', 'O', 'B'; RETURN
    CASE YOB1:    cv!j, cv!k, cv!i := 'Y', 'O', 'B'; RETURN
    CASE YOB2:    cv!k, cv!i, cv!j := 'Y', 'O', 'B'; RETURN
    CASE YGO0:    cv!i, cv!j, cv!k := 'Y', 'G', 'O'; RETURN
    CASE YGO1:    cv!j, cv!k, cv!i := 'Y', 'G', 'O'; RETURN
    CASE YGO2:    cv!k, cv!i, cv!j := 'Y', 'G', 'O'; RETURN
    CASE YRG0:    cv!i, cv!j, cv!k := 'Y', 'R', 'G'; RETURN
    CASE YRG1:    cv!j, cv!k, cv!i := 'Y', 'R', 'G'; RETURN
    CASE YRG2:    cv!k, cv!i, cv!j := 'Y', 'R', 'G'; RETURN
  }
}

AND setedgecols(cv, piece, i, j) BE
{ //writef("setedgecols(%i2, %i2, %i2)*n", piece, i, j)
  SWITCHON piece INTO
  { DEFAULT:      writef("System error in setedgecols: piece=%n*n", piece)
                  abort(999)
  }
}

```

```

CASE WRO:  cv!i, cv!j := 'W', 'R'; RETURN
CASE WR1:  cv!j, cv!i := 'W', 'R'; RETURN
CASE WBO:  cv!i, cv!j := 'W', 'B'; RETURN
CASE WB1:  cv!j, cv!i := 'W', 'B'; RETURN
CASE WOO:  cv!i, cv!j := 'W', 'O'; RETURN
CASE WO1:  cv!j, cv!i := 'W', 'O'; RETURN
CASE WGO:  cv!i, cv!j := 'W', 'G'; RETURN
CASE WG1:  cv!j, cv!i := 'W', 'G'; RETURN

CASE BRO:  cv!i, cv!j := 'B', 'R'; RETURN
CASE BR1:  cv!j, cv!i := 'B', 'R'; RETURN
CASE BO:   cv!i, cv!j := 'O', 'B'; RETURN
CASE OB1:  cv!j, cv!i := 'O', 'B'; RETURN
CASE GOO:  cv!i, cv!j := 'G', 'O'; RETURN
CASE GO1:  cv!j, cv!i := 'G', 'O'; RETURN
CASE RGO:  cv!i, cv!j := 'R', 'G'; RETURN
CASE RG1:  cv!j, cv!i := 'R', 'G'; RETURN

CASE YRO:  cv!i, cv!j := 'Y', 'R'; RETURN
CASE YR1:  cv!j, cv!i := 'Y', 'R'; RETURN
CASE YBO:  cv!i, cv!j := 'Y', 'B'; RETURN
CASE YB1:  cv!j, cv!i := 'Y', 'B'; RETURN
CASE YOO:  cv!i, cv!j := 'Y', 'O'; RETURN
CASE YO1:  cv!j, cv!i := 'Y', 'O'; RETURN
CASE YGO:  cv!i, cv!j := 'Y', 'G'; RETURN
CASE YG1:  cv!j, cv!i := 'Y', 'G'; RETURN
}
}

AND goalscore(cube) = VALOF
{ LET k = ?
  LET piece = ?

  //writef("goalscore:*n")
  //prnode(cube)
  //writef("upper edges WR=%n/%n WB=%n/%n WO=%n/%n WG=%n/%n*n",
  //      cube%iWR, WRO,
  //      cube%iWB, WBO,
  //      cube%iWO, WOO,
  //      cube%iWG, WGO)

  // Upper edges
  // Penalties
  // right edge wrong orientation  900
  // wrong edge                      1000

```



```

k := 4*1000
piece := cube%iWR
IF piece=WRO DO k := k-1000
IF piece=WR1 DO k := k-100
piece := cube%iWB
IF piece=WBO DO k := k-1000
IF piece=WB1 DO k := k-100
piece := cube%iWO
IF piece=WOO DO k := k-1000
IF piece=WO1 DO k := k-100
piece := cube%iWG
IF piece=WGO DO k := k-1000
IF piece=WG1 DO k := k-100

// If k=0 upper four edges are correct

// Upper corners
// Penalties
// right corner wrong orientation  700
// wrong corner                      800

k := k + 4*800

piece := cube%iWRB
IF piece=WRBO DO k := k-800
IF piece=WRB1 DO k := k-100
IF piece=WRB2 DO k := k-100
piece := cube%iWBO
IF piece=WBOO DO k := k-800
IF piece=WBO1 DO k := k-100
IF piece=WBO2 DO k := k-100
piece := cube%iWOG
IF piece=WOGO DO k := k-800
IF piece=WOG1 DO k := k-100
IF piece=WOG2 DO k := k-100
piece := cube%iWGR
IF piece=WGRO DO k := k-800
IF piece=WGR1 DO k := k-100
IF piece=WGR2 DO k := k-100

// If k=0 upper layer is now correct

// Middle layer edges
// Penalties
// right edge wrong orientation  250

```

```

// wrong edge                                300

k := k + 4*300

piece := cube%iBR
IF piece=BR0 DO k := k-300
IF piece=BR1 DO k := k- 50
piece := cube%iOB
IF piece=OB0 DO k := k-300
IF piece=OB1 DO k := k- 50
piece := cube%iGO
IF piece=GO0 DO k := k-300
IF piece=GO1 DO k := k- 50
piece := cube%iRG
IF piece=RG0 DO k := k-300
IF piece=RG1 DO k := k- 50

// If k=0 upper and middle layers are now correct

// Lower level edges
// Penalties
// right edge wrong orientation  30
// wrong edge                    40

k := k + 4*40

piece := cube%iYR
IF piece=YR0 DO k := k-40
IF piece=YR1 DO k := k-10
piece := cube%iYB
IF piece=YB0 DO k := k-40
IF piece=YB1 DO k := k-10
piece := cube%iY0
IF piece=Y00 DO k := k-40
IF piece=Y01 DO k := k-10
piece := cube%iYG
IF piece=YG0 DO k := k-40
IF piece=YG1 DO k := k-10

// If k=0 upper and middle layers are now correct
// and down face edges are correct

// Lower level corners
// Penalties
// right edge wrong orientation  15

```

```

// wrong edge                                20

k := k+4*20

piece := cube%iYBR
IF piece=YBR0 DO k := k-20
IF piece=YBR1 DO k := k- 5
IF piece=YBR2 DO k := k- 5
piece := cube%iYOB
IF piece=YOB0 DO k := k-20
IF piece=YOB1 DO k := k- 5
IF piece=YOB2 DO k := k- 5
piece := cube%iYGO
IF piece=YGO0 DO k := k-20
IF piece=YGO1 DO k := k- 5
IF piece=YGO2 DO k := k- 5
piece := cube%iYRG
IF piece=YRG0 DO k := k-20
IF piece=YRG1 DO k := k- 5
IF piece=YRG2 DO k := k- 5

// If k=0 all positions are correct so the Rubik Cube has been solved
//writef("goalscore: returning %n*n", k)
//abort(9000)
RESULTIS k
}

```

4.28 Simple series

We have seen that the largest number we can represent in an unsigned 32-bit word is

$$1 + 2 + 2^2 + 2^3 + \dots + 2^{31}$$

This is perfectly understandable and is called a series, but mathematicians do not normally like to use dots since they introduce possible misunderstandings of what is being omitted. They generally prefer the following notation.

$$\sum_{i=0}^{31} 2^i$$

but in this document I will almost always use the dot notation. We can generalise this series to term n , replacing the constant 2 by some arbitrary value x and call the sum s , namely

$$s = 1 + x + x^2 + x^3 + \dots + x^n$$

We can easily make a simple formula for s by considering s multiplied by $(x - 1)$, that is

$$\begin{aligned} s(x - 1) &= (1 + x + x^2 + x^3 + \dots + x^n) \times x - (1 + x + x^2 + x^3 + \dots + x^n) \\ &= (x + x^2 + x^3 + \dots + x^{n+1}) - (1 + x + x^2 + x^3 + \dots + x^n) \\ &= x^{n+1} - 1 \end{aligned}$$

So

$$s = \frac{x^{n+1} - 1}{x - 1}$$

So for our original series, $x = 2$ and $n = 31$ gives us

$$s = \frac{2^{32} - 1}{2 - 1} = 2^{32} - 1 = 4294967295$$

Notice that with $x = 2$ as n gets larger so does the sum. When $x = 2$, the series is said to diverge as n tends to infinity (an incredibly large number often represented by ∞). But what happens if $x < 1$. Let us try $x = \frac{1}{2}$ and $n = \infty$.

$$s = \frac{\left(\frac{1}{2}\right)^\infty - 1}{\frac{1}{2} - 1} = \frac{0 - 1}{\frac{1}{2} - 1} = 2$$

In the above derivation, we took $\left(\frac{1}{2}\right)^\infty$ to be zero since multiplying 1 by $\frac{1}{2}$ a huge number of times gets so small its value can be ignored. Note that setting $n = \infty$ allows us to deduce that

$$\frac{1}{1-x} = 1 + x + x^2 + x^3 + \dots$$

Although this is only really valid if $|x| < 1$.

As a demonstration of the use of vectors and functions we will look a program called `eva12.b` that calculates s to 2000 decimal places to show that it is indeed 2. It starts as follows.

```

GET "libhdr"

GLOBAL {
  sum:ug
  term
  upb
}

LET start() = VALOF
{ upb := 2004/4 // Each element holds 4 decimal digits
  // and there are 4 guard digits at the end.
  sum := getvec(upb)
  term := getvec(upb)

  settok(sum, 0)
  sum!upb := 5000 // Add 1/2 at digit position 2000 for rounding
  settok(term, 1)

  UNTIL iszero(term) DO
  { add(sum, term)
    divbyk(term, 2)
  }

  // Write out the sum to 40 decimal places
  writef("*nsum = %n.", sum!0)
  FOR i = 1 TO 10 DO writef("%4z ", sum!i)
  newline()

fin:
  freevec(sum)
  freevec(term)
  RESULTIS 0
}

```

It uses the vector `sum` to hold the summation of all the terms and `term` to hold the next term to add to `sum`. Both `sum` and `term` are vectors with upperbound $2004/4$ which is sufficient to hold numbers with 4 decimal digits before the decimal point and 2000 digits after the decimal point together with a further 4 guard digits at the end. `sum` and `term` are initialised by calls of `settok`, described later, and 5000 is placed in the last element of `sum` which corresponds to adding $1/2$ at decimal digit position 2000. This causes appropriate rounding to take place. The `UNTIL` loop adds `term` to `sum` dividing `term` by 2 each time until `term` represents zero. `sum` is then output to 40 decimal places as follows:

```
sum = 2.0000 0000 0000 0000 0000 0000 0000 0000 0000 0000
```

as expected.

The rest of the program defines the functions `settok`, `add`, `divbyk` and `iszero` as follows.

```

AND settok(v, k) BE
{ v!0 := k
  FOR i = 1 TO upb DO v!i := 0
}

AND add(a, b) BE
{ LET c = 0
  FOR i = upb TO 0 BY -1 DO
  { LET d = c + a!i + b!i
    a!i := d MOD 10000
    c := d / 10000
  }
}

AND divbyk(v, k) BE
{ LET c = 0
  FOR i = 0 TO upb DO
  { LET d = c*10000 + v!i
    v!i := d / k
    c := d MOD k
  }
}

AND iszero(v) = VALOF
{ FOR i = upb TO 0 BY -1 IF v!i RESULTIS FALSE
  RESULTIS TRUE
}

```

The function `settok` is self explanatory. Notice that `add` performs the addition from the least significant end using the variable `c` to hold the carry. `divbyk` performs short division from the most significant end, again using `c` to hold the carry. Finally, `iszero` only returns `TRUE` if every element of `v` is zero.

4.29 e to 2000 decimal places

The constant e which has a value of approximately 2.71828 is one of the most important constants in mathematics. It can be defined in many ways, but the one we will use in this section is:

$$e = 1 + 1 + \frac{1}{2} + \frac{1}{3!} + \dots + \frac{1}{n!} + \dots$$

where $n!$ stands for n factorial ($1 \times 1 \times 2 \times 3 \times \dots \times n$).

This section presents a simple program (`evale.b`) that computes e to 2000 decimal places. As with the previous program, it is primarily an example of the use of vectors and functions, and, as with the previous program, it uses high precision numbers using vectors whose elements each contain 4 decimal digits. It is convenient to think of these elements as digits of radix 10000. A radix of 10000 was chosen because 10000^2 easily fits in a 32-bit word, but 100000^2 does not. The program starts as follows.

```
GET "libhdr"

GLOBAL {
  sum:ug  // The sum of terms so far
  term    // The next term to add to sum
  tab     // The frequency counts of the digits of e
  digcount
  digits  // The number of decimal digits to calculate
  upb
}

LET start() = VALOF
{ LET n = 1
  digits := 2000          // Calculate e to 2000 decimal places
  upb := (digits+10)/4    // add ten guard digits
  tab := getvec(9)        // for digit frequency counts
  sum := getvec(upb)      // will hold the sum of the series
  term := getvec(upb)     // the next term in the series to add to sum

  UNLESS tab & sum & term DO
  { writef("Unable to allocate vectors*n")
    GOTO fin
  }

  settok(sum, 1)          // Initial value of sum
  settok(term, 1)         // The first term to add

  UNTIL iszero(term) DO // Until the term is zero
  { add(sum, term)        // Add the term to sum
    n := n + 1
    divbyk(term, n)      // Calculate the next term
  }

  // Write out e
  writes("*ne = *n")
  print(sum)
}
```

```

// Write out the digit frequency counts
writes("*nDigit counts*n")
FOR i = 0 TO 9 DO writef("%n:%i3  ", i, tab!i)
newline()

fin:
  freevec(tab)
  freevec(sum)
  freevec(term)
  RESULTIS 0
}

```

The program ends with the definitions of the functions used, most of which we have already seen.

```

AND settok(v, k) BE
{ v!0 := k // Set the integer part
  FOR i = 1 TO upb DO v!i := 0 // Clear all fractional digits
}

```

```

AND add(a, b) BE
{ LET c = 0
  FOR i = upb TO 0 BY -1 DO
  { LET d = c + a!i + b!i
    a!i := d MOD 10000
    c := d / 10000
  }
}

```

```

AND divbyk(v, k) BE
{ LET c = 0
  FOR i = 0 TO upb DO
  { LET d = c*10000 + v!i
    v!i := d / k
    c := d MOD k
  }
}

```

```

AND iszero(v) = VALOF
{ FOR i = upb TO 0 BY -1 IF v!i RESULTIS FALSE
  RESULTIS TRUE
}

```

The final two functions output the high precision number held in *v* as a sequence of decimal digits.

```

AND print(v) BE
{ FOR i = 0 TO 9 DO tab!i := 0 // Clear the frequency counts
  digcount := 0
  writef(" %i4.", v!0)
  FOR i = 1 TO upb DO
    { IF i MOD 15 = 0 DO writes("*n ")
      wrpn(v!i, 4)
      wrch('*s')
    }
  newline()
}

AND wrpn(n, d) BE
{ IF d>1 DO wrpn(n/10, d-1)
  IF digcount>=digits RETURN
  n := n MOD 10
  tab!n := tab!n + 1
  wrch(n+'0')
  digcount := digcount+1
}

```

When the program is run its output is as follows.

```

e =
  2.7182 8182 8459 0452 3536 0287 4713 5266 2497 7572 4709 3699 9595 7496
  6967 6277 2407 6630 3535 4759 4571 3821 7852 5166 4274 2746 6391 9320 0305
  9921 8174 1359 6629 0435 7290 0334 2952 6059 5630 7381 3232 8627 9434 9076
  3233 8298 8075 3195 2510 1901 1573 8341 8793 0702 1540 8914 9934 8841 6750
  9244 7614 6066 8082 2648 0016 8477 4118 5374 2345 4424 3710 7539 0777 4499
  2069 5517 0276 1838 6062 6133 1384 5830 0075 2044 9338 2656 0297 6067 3711
  ...

  4995 8862 3428 1899 7077 3327 6171 7839 2803 4946 5014 3455 8897 0719 4258
  6398 7727 5471 0962 9537 4152 1115 1368 3506 2752 6023 2648 4728 7039 2076
  4310 0595 8411 6612 0545 2970 3023 6472 5492 9666 9381 1513 7322 7536 4509
  8889 0313 6020 5724 8176 5851 1806 3036 4428 1231 4965 5070 4751 0254 4650
  1172 7211 5551 9486 6850 8003 6853 2281 8315 2196 0037 3562 5279 4495 1582
  8418 8294 7876 1085 2639 8139

Digit counts
0:196  1:190  2:207  3:202  4:201  5:197  6:204  7:198  8:202  9:203

```

The frequency counts have been output because they have the remarkable property of being very much closer to 200 than we should expect. There is a

simple statistical test (the χ^2 test), covered in the next section, that shows just how unlikely these counts are assuming each digit is equally likely to be any digit in the range 0 to 9 and is independent of the other digits in the series.

4.30 The χ^2 test

Feel free to skip this section if the formula below looks too frightening.

The program above showed us that, for e , the counts of each digit in the 2000 digits after the decimal point are 196, 190, 207, 202, 201, 197, 204, 198, 202 and 203. Since there are 2000 digits in all we would expect each to occur about 200 times, but, of course, we would also expect some random deviation from this average. Statisticians have devised a test (the χ^2 test) that allows us to see if our collection of counts is reasonable. The method is as follows. First we calculate the quantity χ^2 defined as follow.

$$\chi^2 = \sum_{i=1}^k \frac{(x_i - \mu_i)^2}{\mu_i}$$

where k is the number of counts, x_i is the i^{th} count and μ_i is the expected value for x_i which in our case is always 200. Putting our counts into the formula we obtain

$$\begin{aligned} \chi^2 &= \frac{(196-200)^2}{200} + \frac{(190-200)^2}{200} + \frac{(207-200)^2}{200} + \frac{(202-200)^2}{200} + \frac{(201-200)^2}{200} + \\ &\quad \frac{(197-200)^2}{200} + \frac{(204-200)^2}{200} + \frac{(198-200)^2}{200} + \frac{(202-200)^2}{200} + \frac{(203-200)^2}{200} \\ &= \frac{16+100+49+4+1+9+16+4+4+9}{200} \\ &= \frac{212}{200} \\ &= 1.06 \end{aligned}$$

We had 10 counts but since they add up to 2000 the last count depends on the first 9, so for our collection the so called number of degrees of freedom is 9. We can lookup our value of χ^2 in the table for 9 degrees of freedom to find the probability that χ^2 would be greater than 1.06, assuming the digits are random and independent of one another. If you search the web using terms **chi squared distribution calculator**, you will find several web pages that will calculate the probability that χ^2 should be greater than 1.06 for 9 degrees of freedom. The answer turns out to be 0.9993, so the chance that χ^2 is 1.06 or smaller is less than one in a thousand.

4.31 e^x

The previous section defined e as the sum of a beautiful series whose n^{th} was $\frac{1}{n!}$. Just for fun let us see what happens when we multiply this series by itself. Clearly the result should be a series representing e^2 . So we have to simplify

$$(1 + \frac{1}{1!} + \frac{1}{2!} + \frac{1}{3!} + \dots) \times (1 + \frac{1}{1!} + \frac{1}{2!} + \frac{1}{3!} + \dots)$$

We can multiply each element of the left hand term by each element of the right hand term in a systematic way as follows

$$\begin{array}{rcll} 1 \times 1 & = & 1 & = 1 \\ \frac{1}{1!} \times 1 + 1 \times \frac{1}{1!} & = & \frac{1+1}{1!} & = \frac{2}{1!} \\ \frac{1}{2!} \times 1 + \frac{1}{1!} \times \frac{1}{1!} + 1 \times \frac{1}{2!} & = & \frac{1+2+1}{2!} & = \frac{2^2}{2!} \\ \frac{1}{3!} \times 1 + \frac{1}{2!} \times \frac{1}{1!} + \frac{1}{1!} \times \frac{1}{2!} + 1 \times \frac{1}{3!} & = & \frac{1+3+3+1}{3!} & = \frac{2^3}{3!} \end{array}$$

This shows that

$$e^2 = 1 + \frac{2}{1!} + \frac{2^2}{2!} + \frac{2^3}{3!} + \dots$$

Seeing this equation leads us to thinking that

$$e^x = 1 + \frac{x}{1!} + \frac{x^2}{2!} + \frac{x^3}{3!} + \dots$$

might be true. After all, it is certainly true when x is 0, 1 or 2. We can increase our believe that it is true by considering the product of the series for e^x and e^y to see if it yields the series for e^{x+y} . We can do this by multiplying each element of the left hand term by each element of the right hand term in a systematic way as follows

$$\begin{array}{rcll} 1 \times 1 & = & 1 & = 1 \\ \frac{x}{1!} \times 1 + 1 \times \frac{y}{1!} & = & \frac{x+y}{1!} & = \frac{(x+y)}{1!} \\ \frac{x^2}{2!} \times 1 + \frac{x}{1!} \times \frac{y}{1!} + 1 \times \frac{y^2}{2!} & = & \frac{x^2+2xy+y^2}{2!} & = \frac{(x+y)^2}{2!} \\ \frac{x^3}{3!} \times 1 + \frac{x^2}{2!} \times \frac{y}{1!} + \frac{x}{1!} \times \frac{y^2}{2!} + 1 \times \frac{y^3}{3!} & = & \frac{x^3+3x^2y+3xy^2+y^3}{3!} & = \frac{(x+y)^3}{3!} \end{array}$$

This shows that

$$e^x \times e^y = 1 + \frac{(x+y)}{1!} + \frac{(x+y)^2}{2!} + \frac{(x+y)^3}{3!} + \dots$$

which correctly represents the series for e^{x+y} , as expected.

So far we have assumed that x and y are integers, but the algebra we have just used works just as well when x and y are not whole numbers. Consider, for example, $e^{\frac{1}{2}}$. This clearly represents \sqrt{e} since

$$e^{\frac{1}{2}} \times e^{\frac{1}{2}} = e^{\frac{1}{2}+\frac{1}{2}} = e$$

Similarly, $e^{\frac{1}{q}}$ is the q^{th} root of e . We can safely assume that our series works for any x of the form $\frac{p}{q}$ where p and q are whole numbers. This leads us to believe the formula is correct even when x cannot be represented as the ratio of two whole numbers. Examples of such numbers are $\sqrt{2}$, π and even e itself.

4.32 The extraordinary number $e^{\pi\sqrt{163}}$

This number is peculiar since it has 18 digits to the left of the decimal point, but a sequence of 12 nines to the right of the decimal point. The following program demonstrates this by computing its value to sufficient precision. The program is called `epr163.b` and starts as follows.

```
GET "libhdr"

MANIFEST
{ upb = 12
  upb1 = upb+1
}

LET start() = VALOF
{ LET pi      = VEC upb
  AND root163 = VEC upb
  AND x       = VEC upb
  AND ex      = VEC upb
  LET exponent = 0

  numfromstr(pi, upb, "3.14159265358979323846264338327950*
                    *288419716939937510582097494459230")
  writef("\nPi is*n")
  print(pi, 0)

  // Calculate root 163
```

```

sqrt163(root163)
writef("nRoot 163 is*n")
print(root163, 0)

mult(x, pi, root163)
writef("nPi times Root 163 is*n")
print(x, 0)

// Divide x by 2**10 (=1024) to make the computation
// e to the power x converge much more rapidly.
divbyk(x, 1024)
exp(ex, x)
// Now square the result 10 times.
FOR i = 1 TO 10 DO
{ exponent := 2*exponent
  mult(ex, ex, ex)
  IF ex!0>10000 DO
  { divbyk(ex, 10000)
    exponent := exponent + 1
  }
}
// Output the result
writef("ne to the Pi root 163 is*n")
print(ex, exponent)
RESULTIS 0
}

```

A high precision number is represented by vector whose elements each contain four decimal digits. It is best to think of them as digits of radix 10000. The zeroth element is the integer part and the other elements contain the fractional digits. The upper bound of the vector is `upb`, set to 12, to allow a precision of over 40 decimal digits which is sufficient for our purposes. Four such vectors `pi`, `root163`, `x`, `ex` are declared to represent π , $\sqrt{163}$, $\pi \times \sqrt{163}$ and $e^{\pi \times \sqrt{163}}$, respectively. The function `numfromstr` is used to initialise `pi` from a string holding the digits of π . The call `sqrt163(root163)` places a representation of $\sqrt{163}$ in `root163`. The product of `pi` and `root163` is placed in `x` using `mult`. Since `x` is about 40, the convergence of the series for e^x would be very slow, so `x` is reduced in size by dividing it by 1024 ($= 2^{10}$) before summing the series for e^x , placing the result in `ex` by the call `exp(ex, x)`. The result in `ex` is then squared 10 times to give a representation of $e^{\pi \times \sqrt{163}}$. The only problem is that this value is outside the range of values our high precision numbers can hold. This is solved by maintaining an exponent value in `exponent` which specified that the number in `ex` should be multiplied by 10000^{exponent} . Each time `ex` is squared, `exponent` is doubled, and

if `ex` has become too large it is divided by 10000 and `exponent` incremented by one.

The additional functions used by this program are as follows.

```

AND numfromstr(v, upb, s) BE
{ LET p, k, val = 0, 0, k
  FOR i = 1 TO s%0 DO
  { LET ch = s%i
    IF '0'<=ch<='9' DO val, k := 10*val + ch - '0', k+1
    IF ch='.' | k=4 DO
    { IF p<=upb DO v!p := val
      p, k, val := p+1, 0, 0
    }
  }
  UNTIL k=4 DO val, k := 10*val, k+1
  IF p<=upb DO v!p := val
  // Pad on the right with zeroes
  UNTIL p>=upb DO { p := p+1; v!p := 0 }
}

```

This takes a character string in `s` and converts it into our high precision representation using the vector `v` whose upper bound is `upb`.

```

AND sqrt163(x) BE
{ // This is a simple but inefficient function to
  // calculate the square root of 163.
  LET w = VEC upb
  AND eps = VEC upb
  AND n163 = VEC upb
  numfromstr(x, upb, "13.") // Initial guess
  numfromstr(n163, upb, "163.")

  { mult(w, x, x)
    TEST w!0>=163 THEN { sub(eps, w, n163)
                        divbyk(eps, 24)
                        sub(x, x, eps)
                      }
    ELSE { sub(eps, n163, w)
          divbyk(eps, 24)
          add(x, x, eps)
        }
  }

  //print(x, 0)
}

```

```

} REPEATUNTIL iszero(eps)
}

```

As the comment says this is a simple function to set x to a high precision representation of $\sqrt{163}$. There was no need to use the much faster Newton-Raphson method.

```

AND mult(x, y, z) BE
{ LET res = VEC upb1
  numfromstr(res, upb1, "0.")
  // Round by adding a half to the last digit position.
  res!upb1 := 5000
  FOR i = 0 TO upb IF y!i FOR j = 0 TO upb1-i DO
  { LET p = i + j // p is in range 0 to upb1
    LET carry = y!i * z!j
    WHILE carry DO
    { LET w = res!p + carry
      IF p=0 DO { res!0 := w; BREAK }
      res!p, carry := w MOD 10000, w/10000
      p := p-1
    }
  }
  FOR i = 0 TO upb DO x!i := res!i
}

```

This function multiplies the high precision numbers in y and z placing the rounded result in x . It uses a temporary vector res that includes an extra digit to allow for rounding. Every pair of digits that can contribute to the result are multiplied together and added to the appropriate position in res , dealing with carries as they arise.

```

AND exp(ex, x) BE
{ // This calculates e to the power x by summing the series
  // whose nth term is x**n/n!
  LET n = 0
  LET term = VEC upb
  numfromstr(term, upb, "1.")
  numfromstr(ex, upb, "0.")
  UNTIL iszero(term) DO
  { add(ex, ex, term)
    n := n+1
    mult(term, term, x)
  }
}

```

```

    divbyk(term, n)
  }
}

```

This computes e^x using the series

$$e^x = 1 + x + \frac{x^2}{2!} + \frac{x^3}{3!} + \frac{x^4}{4!} + \dots$$

The result is accumulated in `ex` and `term` holds the next term to be added. The summation stops when `term` holds zero.

```

AND add(x, y, z) BE
{ LET c = 0
  FOR i = upb TO 0 BY -1 DO
  { LET d = c + y!i + z!i
    x!i := d MOD 10000
    c := d / 10000
  }
}

```

This function adds the high precision numbers in `y` and `z` placing the result in `x`.

```

AND sub(x, y, z) BE
{ LET borrow = 0
  FOR i = upb TO 1 BY -1 DO
  { LET d = y!i - borrow - z!i
    borrow := 0
    UNTIL d >= 0 DO borrow, d := borrow+1, d+10000
    x!i := d
  }
  x!0 := y!0 - borrow - z!0
}

```

This function subtracts the high precision number in `z` from `y` placing the result in `x`.

```

AND divbyk(v, k) BE
{ LET c = 0
  FOR i = 0 TO upb DO
  { LET d = c*10000 + v!i
    v!i := d / k
    c := d MOD k
  }
}

```

This divides the high precision number in v by k which must be in the range 1 to 10000.

```
AND iszero(v) = VALOF
{ FOR i = upb TO 0 BY -1 IF v!i RESULTIS FALSE
  RESULTIS TRUE
}
```

This returns TRUE is the high precision number in v is zero.

```
AND print(v, exponent) BE
{ writef("%i4", v!0)
  FOR i = 1 TO upb DO
  { wrch(exponent=0 -> '.', '*s')
    exponent := exponent - 1
    IF i MOD 15 = 0 DO newline()
    wrpn(v!i, 4)
  }
  newline()
}
```

```
AND wrpn(n, d) BE
{ IF d>1 DO wrpn(n/10, d-1)
  wrch(n MOD 10 +'0')
}
```

These two functions combine to output a high precision number with a given exponent.

When this program runs, its output is as follows.

```
Pi is
 3.1415 9265 3589 7932 3846 2643 3832 7950 2884 1971 6939 9375
```

```
Root 163 is
12.7671 4533 4803 7046 6171 0952 0097 8089 2347 3823 6377 9407
```

```
Pi times Root 163 is
40.1091 6999 1132 5197 5535 0083 6229 0414 0053 9005 3481 5142
```

```
e to the Pi root 163 is
26 2537 4126 4076 8743.9999 9999 9999 2500 7259 7198 1820 2936
```

4.33 Digits of π

This section is another illustration of the use of modulo arithmetic. It is entirely optional and can be skipped.

The ratio of the circumference of a circle to its diameter is a very important constant called π , and it has a value of about 3.14159, and some people like to use the approximations $\frac{22}{7}$ or $\frac{355}{113}$. In the mid 1930s, π was known to about 700 decimal places but now, with the aid of computers and staggeringly cunning methods it can be calculated to billions (and even trillions) of decimal places. For more information do a web search on: **digits of pi**.

One intriguing method was discovered by David Bailey, Peter Borwein and Simon Ploffe and appears in section 10.7 of “Number Theory, A Programmer’s Guide” by Mark Herkommer. It is based on the totally remarkable formula:

$$\pi = \sum_{i=0}^{\infty} \left(\frac{4}{8i+1} - \frac{2}{8i+4} - \frac{1}{8i+5} - \frac{1}{8i+6} \right) \times \left(\frac{1}{16} \right)^i$$

The beauty of this formula is that it can be used to calculate the n^{th} hexadecimal digit of π using modulo arithmetic with the big advantage that the other digits are not computed. So how do we do it?

We multiply the right hand side by 16^n and split it into the first n terms and the rest, namely

$$\sum_{i=0}^{n-1} \left(\frac{4 \times 16^{n-i}}{8i+1} - \frac{2 \times 16^{n-i}}{8i+4} - \frac{16^{n-i}}{8i+5} - \frac{16^{n-i}}{8i+6} \right)$$

and

$$\sum_{i=n}^{\infty} \left(\frac{4}{8i+1} - \frac{2}{8i+4} - \frac{1}{8i+5} - \frac{1}{8i+6} \right) \times \left(\frac{1}{16} \right)^{i-n}$$

If we add these two sums together, we obtain a huge number, and if we represent it using hexadecimal digits we find that the first digit to the right of the decimal point is the n^{th} hex digit of π . If we are only interested in this digit all the digits to the left of the decimal point can be discarded and only a few to the right of the decimal point need to be retained during the calculation. Let us consider the first term in the first sum. The contribution this term makes to the result is

$$\sum_{i=0}^{n-1} 4 \left(\frac{16^{n-i}}{8i+1} \right)$$

But we are only interested in the fractional part, so the following sum will do just as well.

$$\sum_{i=0}^{n-1} 4 \left(\frac{16^{n-i} \bmod (8i+1)}{8i+1} \right)$$

Computing $16^{n-i} \bmod (8i+1)$ throws away all integer multiples of $(8i+1)$ leaving only the remainder, which is positive but less than $8i+1$, so when this is divided by $8i+1$ yields a value between 0 and 1. This trick is similar to calculating the fractional part of $123/10$ as follow:

$$\frac{123 \bmod 10}{10} = \frac{3}{10} = 0.3$$

A program to output the digits of π in hexadecimal and decimal is in `bcplprogs/raspi/pidigs.b`. It starts as follows:

```
GET "libhdr"

MANIFEST {
// Define the scaled arithmetic parameters
fraclen = 28          // Number of binary digits after the decimal point
                      // 28 allows numbers in the range -8.0 <= x < 8.0
One   = 1<<fraclen    // eg #x10000000
Two   = 2*One        // eg #x20000000
Four  = 4*One        // eg #x40000000
fracmask = One - 1   // eg #x0FFFFFFF

upb = 1000
}

LET start() = VALOF
{ LET hexdig = getvec(upb)

  writef("\nPi in hex*n")
  writef("\n      3.")
  hexdig!0 := 3
  FOR n = 1 TO upb DO {
    LET dig = pihexdig(n-1)
    IF n MOD 50 = 1 DO writef("\n%5i: ", n)
    writef("%x1", pihexdig(n)); deplete(cos)
  }
  newline()

  writef("\nPi in decimal*n")
  writef("\n      3.")
```

```

FOR i = 1 TO upb DO
{ IF i MOD 50 = 1 DO writef("*n%5i: ", i)
  hexdig!0 := 0          // Remove the integer part then
  mulby10(hexdig, upb) // multiply the fraction by 10 to obtain
  writef("%n", hexdig!0) // the next decimal digit in hexdig!0
  deplete(cos)
}
newline()
freevec(hexdig)
RESULTIS 0
}

```

The constant `fraclen` (=28) specifies the number of binary digits after the decimal point of the scaled numbers we will be using. This leaves 4 bits (or one hexadecimal digit) to the left of the decimal point. We will be using signed arithmetic, so this allows us to represent numbers greater than or equal to `-8.000` and less than `8.000` which is sufficient for our purposes. The constants `One`, `Two` and `Four` represent the numbers 1, 2 and 4 in this scaled representation, and `fracmask` is a bit pattern that will extract just the fractional bits of our numbers.

The main function `start` outputs the hexadecimal digits of π up to position 1000, placing 50 digits per line. Each digit is calculated by calls of `pihexdig`. These digit are saved in the vector `hexdig` to allow them to be converted to decimal. The conversion to decimal is simple. It just requires setting the integer part (held in `hexdig!0`) to zero before multiplying the fraction in hex by decimal 10 giving the next decimal digit in `hexdig!0`. The calculation is outlined below.

```

3.14159265 => 0.14159265 * 10 => 1.4159265
1.4159265  => 0.4159265  * 10 => 4.159265
4.159265   => 0.159265   * 10 => 1.59265
1.59265    => 0.59265    * 10 => 5.9265
5.9265     => 0.9265     * 10 => 9.265

```

The multiplication by 10 is done by `mulby10` defined as follows.

```

AND mulby10(v, upb) BE
{ // v contains one hex digit per element with the
  // decimal point between v!0 and v!1
  LET carry = 0
  FOR i = upb TO 0 BY -1 DO
  { LET d = v!i*10 + carry
    v!i, carry := d MOD 16, d/16
  }
}
}

```

The library function `muldiv` take three signed numbers and returns the mathematically correct result of dividing the third argument into the product of the first two. Thus `muldiv(x,y,z)=(x*y)/z`, but `x*y` is computed as a double length quantity. The function `powmod(x,n,m)`, defined later, computes $x^n \bmod(m)$ with reasonably efficiently. Note that

```
muldiv(Four, powmod(16, n-i, 8*i+1), 8*i+1)
```

will return the value of

$$4\left(\frac{16^{n-i} \bmod(8i+1)}{8i+1}\right)$$

as a number using our scaled representation. The definition of `pihexdig` is as follows.

```
AND pihexdig(n) = VALOF
{ // By convention, the first hex digit after the decimal point
  // is at position n=0
  LET s = 0 // A scaled number with fraclen binary digits
           // after the decimal point.
  LET t = One

  FOR i = 0 TO n-1 DO
  { LET a = muldiv(Four, powmod(16, n-i, 8*i+1), 8*i+1)
    LET b = muldiv( Two, powmod(16, n-i, 8*i+4), 8*i+4)
    LET c = muldiv( One, powmod(16, n-i, 8*i+5), 8*i+5)
    LET d = muldiv( One, powmod(16, n-i, 8*i+6), 8*i+6)

    s := s + a - b - c - d & fracmask
  }

  // Now add the remaining terms until they are too small
  // to matter.
  { LET i = n
    WHILE t DO
    { LET a = 4 * t / (8*i+1)
      LET b = 2 * t / (8*i+4)
      LET c =   t / (8*i+5)
      LET d =   t / (8*i+6)

      s := s + a - b - c - d & fracmask
      i, t := i+1, t/16
    }
  }
```

```

}

RESULTIS (s>>(fraclen-4)) & #xF // Extract the required digit
}

```

To complete the program, the definition of `powmod` is as on Page 65, namely

```

AND powmod(x, n, m) = VALOF
{ LET res = 1
  LET p = x MOD m
  WHILE n DO
  { UNLESS (n & 1)=0 DO res := (res * p) MOD m
    n := n>>1
    p := (p*p) MOD m // DANGER: p*p must not overflow
  }
  RESULTIS res
}

```

The actual program in `raspi/pidigs.b` contains some optional tracing code as a debugging aid. The values of `a`, `b`, `c`, `d`, and `s` can be output in decimal and hexadecimal as they are computed using the function `tr`, as in `tr("a", a)`. The definition of `tr` is as follows.

```

AND tr(str, x) BE
{ // Output scaled number x in decimal and hex
  LET d = muldiv( 1_000_000, x, One)
  LET h = muldiv(#x10000000, x, One) // Just in case fraclen is not 28
  writef("%s = %9.6d %8x*n", str, d, h)
}

```

When `pidigs` runs it generates the following output.

```
0.000> pidigs
```

```
Pi in hex
```

```

3.
1: 243F6A8885A308D313198A2E03707344A4093822299F31D008
51: 2EFA98EC4E6C89452821E638D01377BE5466CF34E90C6CC0AC
101: 29B7C97C50DD3F84D5B5B54709179216D5D98979FB1BD1310B
151: A698DFB5AC2FFD72DBD01ADFB7B8E1AFED6A267E96BA7C9045
201: F12C7F9924A19947B3916CF70801F2E2858EFC16636920D871
251: 574E69A458FEA3F4933D7E0D95748F728EB658718BCD588215
301: 4AEE7B54A41DC25A59B59C30D5392AF26013C5D1B023286085
351: FOCA417918B8DB38EF8E79DCB0603A180E6C9E0E8BB01E8A3E

```

```

401: D71577C1BD314B2778AF2FDA55605C60E65525F3AA55AB9457
451: 48986263E8144055CA396A2AAB10B6B4CC5C341141E8CEA154
501: 86AF7C72E993B3EE1411636FBC2A2BA9C55D741831F6CE5C3E
551: 169B87931EAFD6BA336C24CF5C7A325381289586773B8F4898
601: 6B4BB9AFC4BFE81B6628219361D809CCFB21A991487CAC605D
651: EC8032EF845D5DE98575B1DC262302EB651B8823893E81D396
701: ACC50F6D6FF383F442392E0B4482A484200469C8F04A9E1F9B
751: 5E21C66842F6E96C9A670C9C61ABD388F06A51A0D2D8542F68
801: 960FA728AB5133A36EEF0B6C137A3BE4BA3BF0507EFB2A98A1
851: F1651D39AF017666CA593E82430E888CEE8619456F9FB47D84
901: A5C33B8B5EBEE06F75D885C12073401A449F56C16AA64ED3AA
951: 62363F77061BFEDF72429B023D37D0D724D00A1248DB0FEAD3

```

Pi in decimal

3.

```

1: 14159265358979323846264338327950288419716939937510
51: 58209749445923078164062862089986280348253421170679
101: 82148086513282306647093844609550582231725359408128
151: 48111745028410270193852110555964462294895493038196
201: 44288109756659334461284756482337867831652712019091
251: 45648566923460348610454326648213393607260249141273
301: 72458700660631558817488152092096282925409171536436
351: 78925903600113305305488204665213841469519415116094
401: 33057270365759591953092186117381932611793105118548
451: 07446237996274956735188575272489122793818301194912
501: 98336733624406566430860213949463952247371907021798
551: 60943702770539217176293176752384674818467669405132
601: 00056812714526356082778577134275778960917363717872
651: 14684409012249534301465495853710507922796892589235
701: 42019956112129021960864034418159813629774771309960
751: 51870721134999999837297804995105973173281609631859
801: 50244594553469083026425223082533446850352619311881
851: 71010003137838752886587533208381420617177669147303
901: 59825349042875546873115956286388235378759375195778
951: 18577805321712268066130019278766111959092164201989
2.990>

```

By changing to bounds of the FOR loop in `start` and disabling the decimal conversion, you can discover that the hexadecimal digit at position one million is 6, which I think is remarkable for such a small program. But beware, 28 fractional bits does not have sufficient precision to guarantee all digits from position zero to one million are correct. Try reducing `fracLen` to see where errors begin to creep in. For instance, if `fracLen=22` the first error is at position 1269, and 25 gives an

error at 3708. 28 gives correct digits at least up to position 5000. Unfortunately, if you want more than 28 bits the program will need substantial modification.

4.34 More commands

The programs given so far have included examples of most of the constructs available in BCPL. This section just describes a few of them in more detail.

We should now be familiar with the `IF` and `UNLESS` statements that allow the conditional execution of commands based on the values returned by expressions. The convention is that a value of zero represents false and any non zero value represents true. For convenience, the keywords `FALSE` and `TRUE` have values zero and `-1`. Note that the bit pattern operators `&`, `|` and `~` work well with this representation of truth values. For instance, `(TRUE & FALSE) = FALSE` and `(FALSE | ~FALSE) = TRUE`. However, there is one subtlety which is as follows. When an expression is used in a conditional statement controlling the flow of execution, the operators `&`, `|` and `~` are evaluated slightly differently. For instance, in the command `IF x=0 & y>3 RESULTIS 13`, if the value of `x` is non zero the condition `y>3` will not be evaluated since it is already known that the `RESULTIS` statement will not be executed. The expression `x=0 & y>3` in this example is being evaluated in what is called Boolean context. Whereas in the assignment `sw := x=0 & y>3` both `x=0` and `y>3` are evaluated before being anded together. The only places where expressions are evaluated in a Boolean contexts are those used in `IF`, `UNLESS`, `TEST`, `WHILE`, `UNTIL`, `REPEATWHILE`, `REPEATUNTIL`, and the expression to the left of `->` in a conditional expression. It is important to know when an expression is being evaluated in a Boolean context since, for instance, the following two statements are not equivalent.

```
IF x & 7 RESULTIS 12
IF (x & 7) ~= 0 RESULTIS 12
```

The first will execute the `RESULTIS` statement whenever `x` is non zero, but the second will only do so if the least significant three bits of `x` are not all zero.

The `IF` and `UNLESS` commands allow for the conditional execution of a command. If you wish to conditionally execute one of two commands you should use the `TEST` commands, as in

```
TEST tracing
THEN writef("\nSignal tracing now on\n")
ELSE writef("\nSignal tracing turned off\n")
```

It is sometimes necessary to select one of many alternative command based on the value of an expression. This is often done using the `SWITCHON` command as in:

```

SWITCHON op INTO
{ DEFAULT:  writef("Unkown operator %n*n", op)
             abort(999)
             ENDCASE
  CASE Pos:                               ENDCASE
  CASE Neg:  a := - a;                     ENDCASE
  CASE Add:  a := b + a; ENDCASE
  CASE Sub:  a := b - a; ENDCASE
  CASE Mul:  a := b * a; ENDCASE
  CASE Div:  a := b / a; ENDCASE
  CASE Mod:  a := b MOD a; ENDCASE
}

```

Here the value of `op` is inspected and compared with `Pos`, `Neg`, `Add`, `Sub`, `Mul`, `Div` and `Mod`, all of which must have been declared as `MANIFEST` constant. If `op` is not equal to any of them control passed to the default label, otherwise execution continues at the appropriate `CASE` label. The `ENDCASE` statement cause a jump to just after the `SWITCHON` command. Although `MANIFEST` constants are often used in `CASE` label, numerical and character constants are frequently used.

In addition to `ENDCASE`, there are several other special jump commands. `BREAK` causes a jump out of the current repetitive command. The repetitive commands are those with keywords `WHILE`, `UNTIL`, `REPEATWHILE`, `REPEATUNTIL`, `REPEAT` and `FOR`. `LOOP` causes a jump to end of the body of a repetitive command normally to where the repetition condition is re-evaluated. For a `REPEAT` command, it jumps to the start of the body and for a `FOR` command it jumps to where the control variable is incremented. The other jump commands are `RESULTIS` which jumps to the end of the current `VALOF` expression carrying with it the result, and, finally, `RETURN` causes a return from the current fuction. Careful use of these commands almost eliminates the need to ever use the `GOTO` command.

4.35 The VSPL Compiler

As a final example we will look at a somewhat more substantial program.

BCPL was originally written to help with the implementation of programming language compilers, and its own compiler is a good example. It is, however, too long and complicated to be used as an introduction to compiler writing. A much simpler language called VSPL (Very Simple Programming Language) was designed as an educational tool showing how a compiler can be written in several languages using different programming styles. If you are interested, look at the VSPL distribution available from my home page. The standard BCPL distribution includes the BCPL version of the VSPL compiler in `com/vspl.b` together with two example programs `primes.vs` and `demo.vs` in the BCPL root directory. When printed `vspl.b` is only 21 pages long, but does contain a lexical

analyser, a parser, a translation phase and an interpreter to execute the compiled code. It also contains debugging aids to help you understand how the compiler works.

To explore the VSPL system, try typing the following commands.

```
cd $BCPLROOT          -- Enter the BCPLROOT directory
cintsys               -- Start the BCPL system
c bc vspl             -- Compile the VSPL compiler
type primes.vs       -- Look at a typical VSPL program
vspl primes.vs        -- Compile and run it
type demo.vs         -- Look at a tiny demo program
vspl -l demo.vs       -- Look at the result of lexical analysis
vspl -p demo.vs       -- Look at the parse tree
vspl -c demo.vs       -- Look at the compiled code
vspl -t demo.vs       -- Trace the execution of the compiled code
```

For more information look at the VSPL distribution available via my home page.

4.36 Summary of BCPL

This section gives a brief summary of BCPL. For a full description of the language look at the BCPL Manual ([bcplman.pdf](#)) given in my home page.

In the syntactic forms given below

E denotes an expression,
K denotes a constant expression,
C denotes a command,
D denotes a definition,
A denotes a function argument list,
N denotes a variable name,

4.36.1 Comments and GET

Text between `//` and the end of the line is ignored. The symbols `/*` and `*/` are called comment brackets. These brackets and the text enclosed between them are ignored. Such comments may be nested.

A GET directive of the form `GET "filename"` as in `GET "libhdr"` is replaced by the contents of the specified file. GET first searches the current directory and then the directories specified by the `BCPLHDRS` environment variable. If the file name does not end with `.h` or `.b`, `.h` is appended.

4.36.2 Sections

A section is a sequence of declarations optionally preceded by a SECTION directive of the form SECTION "*name*". Several sections can occur in one file separated by dots.

4.36.3 Declarations

LET *D* AND ... AND *D*

AND joins simultaneous definitions together. All the variables defined have a scope starting at the word LET.

MANIFEST { *N* = *K* ; ... ; *N* = *K* }

The "= *K*"s are optional. When omitted the next available integer is used.

STATIC { *N* = *K* ; ... ; *N* = *K* }

The "= *K*"s are optional. When omitted the the corresponding variables have undefined initial values.

GLOBAL { *N* : *K* ; ... ; *N* : *K* }

The ": *K*"s are optional. When omitted the next available integer is used.

4.36.4 Definitions

Definitions are used in declarations after the word LET or AND. They are as follows.

N , ... , *N* = *E* , ... , *E*

This is a simultaneous definition defining a list of local variables with specified initial values. They are allocated consecutive locations in memory.

N = VEC *K*

This is a local vector definition. It defines a local variable *N* with an initial value that points to the zeroth element of a local vector whose upper bound is the constant *K*.

N (*N* , ... , *N*) = *E*

This defines a function that returns a result specified by the expression *E*. It has zero or more arguments.

N (*N* , ... , *N*) BE *C*

This defines a function just like the one above but has no specified result.

4.36.5 Expressions

N Eg: abc v1 a s_err

These are used to name functions, variables and constants.

numb Eg: 1234 #x7F_0001 #377 #b_0111_1111_0000

These yield specified constant values.

?

This yields an undefined value.

TRUE FALSE

These represent the two truth values -1 and 0, respectively.

char Eg: 'A' '*n'

These character constants are encoded as numbers in the range 0 to 255.

string Eg: "abc" "Hello*n"

A string is represented by a pointer to where the characters of the string are packed. The individual characters are encoded as 8-bit bytes and can be accessed using the percent operator %. The zeroth character of a string holds its upper bound.

TABLE *K* , . . . , *K*

This yields an initialised static vector. The elements of the vector are initialised to the given compile time constants.

VALOF *C*

This introduces a new scope for locals and defines the context for RESULTIS commands within *C*.

(*E*)

Parentheses are used to override the normal precedence of the expression operators.

E (*E* , . . . , *E*)

This is a function call.

@ *E*

This returns the address of *E* which must be either a variable name or of the form *E!E* or *!E*.

E ! *E* ! *E*

This is the subscription operator. The left operand is a pointer to the zeroth element of a vector and the right hand operand is an integer subscript. The form *!E* is equivalent to *E!0*.

E % *E*

This is the byte subscription operator. The left operand is a pointer to the zeroth element of a byte vector and the right hand operand is an integer subscript.

+ *E* - *E* ABS *E*

These are monadic operators for plus, minus and absolute value, respectively.

E * *E* *E* / *E* *E* MOD *E*

These are dyadic operators for multiplication, division, remainder after division, respectively.

$E + E$ $E - E$

These are dyadic operators for addition and subtraction, respectively.

$E \text{ relop } E \text{ relop } \dots \text{ relop } E$

where *relop* is any of =, \sim =, <, <=, > or >=. It return TRUE only if all the individual relations are satisfied.

$E \ll E$ $E \gg E$

These are logical left and right shift operators, respectively.

$\sim E$

This returns the bitwise complement of *E*.

$E \& E$

This returns the bitwise AND of its operands.

$E | E$

This returns the bitwise OR of its operands.

$E \text{ XOR } E$

This returns the bitwise exclusive OR of its operands.

$E \rightarrow E, E$

This is the conditional expression construct.

4.36.6 Commands

$E, \dots, E := E, \dots, E$

This is the simultaneous assignment operator. The order in which the expressions are evaluated is undefined.

TEST *E* THEN *C* ELSE *C*

IF *E* DO *C*

UNLESS *E* DO *C*

These are the conditional commands. They are less binding than assignment.

SWITCHON *E* INTO *C*

DEFAULT:

CASE *K*:

ENDCASE

The DEFAULT label and CASE labels identify positions within the body of a SWITCHON command. The effect of a SWITCHON command is to evaluate *E* and then transfer control to the matching CASE label. If no CASE label matches control is passed to the DEFAULT label, but if there is no DEFAULT label control exits from the SWITCHON command. ENDCASE causes an exit from the SWITCHON command. It normally occurs at the end of the code for each case.

WHILE *E* DO *C*

UNTIL *E* DO *C*

```

C REPEATWHILE E
C REPEATUNTIL E
C REPEAT
FOR N = E TO E BY K DO C
FOR N = E TO E DO C

```

These are the repetitive commands. The FOR command introduces a new scope for locals, and *N* is a new variable within this scope.

```
RESULTIS E
```

This returns from current VALOF expression with the given value.

```
RETURN
```

Return from current function with an undefined value.

```
BREAK LOOP
```

Respectively, exit from, or loop in the current repetitive command.

```
N:
```

```
GOTO E:
```

The construct *N:* sets a label to this point in the program, and the GOTO command can be used to transfer to this point. However, the GOTO and the label must be in the same function.

```
C ; ... ; C
```

Evaluate the commands from left to right.

```
{ C ; ... ; C }
```

This construct is called a compound command and is treated syntactically as a single command. It can, for instance, be the operand of an IF statement. A sequence of declaration is permitted immediately after the open section bracket (*{*). This causes it to be called a block. The declared names have a scope limited to the block.

4.36.7 Constant expressions

These are used in MANIFEST, STATIC and GLOBAL declarations, in VEC definitions, and in the step length of FOR commands.

The syntax of constant expressions is the same as that of ordinary expressions except that only constructs that can be evaluated at compile time are permitted.

These are:

```

N, numb, ?, TRUE, FALSE, char,
( K ),
+ K, - K, ABS K,
K * K, K / K, K MOD K
K + K, K - K,
K relop K relop ... relop K,

```

$K \ll K, K \gg K,$
 $\sim K,$
 $K \& K,$
 $K | K,$
 $K \text{ XOR } K,$
 $K \rightarrow K, K$

4.37 Debugging Techniques

It is common to make mistakes when writing a large program. Such errors may cause the program to produce incorrect results or even cause a crash. Errors in programs have become known as bugs and removing them is known as debugging. Even the most carefully written programs tend to contain bugs and it seems almost impossible to create a large programs with fewer than about one bug every 3000 lines of source code. We therefore have to learn to live with bugs since modern systems often involve millions of line of code. In such a program the removal of a known bug may be inadvisable since its correction may introduce one or more unknown bugs.

Bugs can also occur in computer hardware. Probably the most famous example is the FDIV bug detected in some Pentium chips in 1984. The FDIV instruction would very occasionally produce a slightly inaccurate result. It was estimated that this occurred about once in every 9 billion executions of FDIV on random data.

How can we produce reliable software in the presence of software (and hardware) bugs. This is an important problem since there are many situations where software errors can cause loss of life. For instance, modern jet airliners are typically flown by computer and even when the pilot takes control the computer still have a significant effect. One major airliner uses three independent computers to calculate the required positions of the control surfaces such as the rudder and ailerons. They each control independent hydraulic systems to move the surfaces and have the property that if one of the computer fails, the other two have sufficient strength to force the correct result. As an added safety measure the software for the three machines are implemented by independent teams of programmers, but even then they may all make the same errors having incorporated identical algorithms taken published books or research papers. This suggests that it may be worth dynamically checking the accuracy of results. For instance, after computing $r = a/b$ it might be worth checking that $r \times b$ is sufficiently close to a . Similar checks could be made for square root and the trigonometric functions. Such code would probably have detected the FDIV bug much earlier. I am personally happy to know that there are human pilots in the cockpit since they would notice if the computer system suddenly decided to turn the aircraft upside down causing them

to take control. Surprisingly, in cloud, the passengers would probably not notice what had happened.

An important part of a programmers job is clearly the tracking down and correction of bugs. The most important advice is to program with extreme care and spend plenty of time proof reading the code. A useful aid to proof reading is the construction of cross reference listings. For instance, a cross reference listing of the BCPL compiler is the file `BCPL/cintcode/xrefbcpl`. It was constructed by the following command sequence.

```
cd BCPL/cintcode
cintsys
delete xrefbcpl
bmake xrefbcpl
```

This uses the `bmake` command which reads the file: `bmakefile` containing the following relevant lines.

```
xrefbcpl <= com/bcpl.b com/bcplfe.b com/bcplcgcin.b
           sysb/blib.b sysb/dlib.b
<<
delete -f rawxref
c bs blib "ver rawxref xref"
c bs dlib "ver rawxref xref"
c bc bcpl "ver rawxref xref"
sortxref rawxref to xrefbcpl
delete rawxref
>>
```

These invoke the BCPL compiler to compile `blib`, `dlib` and `bcpl` using the `xref` option to append cross reference lines to the file `rawxref`. The `xref` option causes the compiler to append a line of cross reference information every time it encounters a name while translating the parse tree representation of a program into OPCODE. Information concerning names corresponding to function arguments or local variables are not included, since the usage of function names, static variables and manifest constants is much more useful. The lines in `rawxref` are then sorted into alphabetical order using `sortxref` which also removes duplicate lines. A few lines from `xrefbcpl` are as follows.

```
translate G:218 DEF bcplfecg.h[126] translate=
translate G:218 LG ../cintcode/com/bcplfe.b[527] translate(tree)
translate G:218 RT ../cintcode/com/bcplfe.b[2437] LET translate(x)BE..
transname G:333 DEF ../cintcode/com/bcplfe.b[2392] transname=
transname G:333 LG ../cintcode/com/bcplfe.b[3196]
           transname(x,s_lp,s_lg,s_ll,s_lf,s_ln)
```



```

transname G:333 LG ../cintcode/com/bcplfe.b[3281]
    transname(x,s_llp,s_llg,s_lll,0,0)
transname G:333 LG ../cintcode/com/bcplfe.b[3511]
    transname(x,s_sp,s_sg,s_sl,0,0)
transname G:333 RT ../cintcode/com/bcplfe.b[3587]
    LET transname(x,p,g,l,f,n)BE..

```

These show that the routine `translate` was defined to be global 218 on line 126 of the header file `bcplfecg.h`. It was called on line 527 of `bcplfecg.b` and its definitions starts on line 2437 of the same file. Similarly, the routine `transname` was defined on line 2392 of file `bcplfecg.b` to be global 333, and called on lines 3196, 3281 and 3511. Its definition starts at line 3587. We can also see that the definition and the calls all take 6 arguments.

The cross reference listing is particularly useful for checking global number allocation, mis-spelling of names and that the arguments of function calls match their definitions and occur in the right order.

Many programming errors are detected by the compiler and are easily corrected. The more difficult errors are usually not detected until the program is run and some may go undetected for weeks or months until the exact state is encountered that causes the program to fail. It is a good strategy to incorporate code to check the validity of certain variables, particularly some function argument, pointers and array subscripts. Such checks do not significantly increase the program size and, unless they occur in tight inner loops, will have little effect on the execution time.

The following sections suggest other ways to aid debugging.

4.37.1 Adding debugging output to a program

Perhaps the simplest way to help debug a program is to add debugging statements to the program. The BCPL compiler has such statements to help debug its lexical analyser, syntax analyser, translation phase and codegenerator. Starting a program with a question mark will cause the compiler to output a trace of its lexical tokens, as shown below.

```

solestreet:$ cd ~/distribution/BCPL/bcplprogs/tests
solestreet:$ cintsys

```

```

BCPL 32-bit Cintcode System (21 Oct 2015)

```

```

0.000> type tst1.b

```

```

?
```

```

GLOBAL { start:1; f:300 }

```

```

LET start() = VALOF

```

```

{ LET a = 12

```

```

    LET b = 24
    RESULTIS a/(2*a-b) + f(b)
}

```

```
0.000> bcpl tst1.b
```

```
BCPL (10 Oct 2014) with simple floating point
```

```

token = 68 ln=    2 GLOBAL
token = 79 ln=    2 LSECT
token =  2 ln=    2 NAME          start
token = 45 ln=    2 COLON
token =  1 ln=    2 NUMBER        1
token = 82 ln=    2 SEMICOLON
token =  2 ln=    2 NAME          f
token = 45 ln=    2 COLON
token =  1 ln=    2 NUMBER        300
token = 80 ln=    2 RSECT
token = 65 ln=    4 LET
token =  2 ln=    4 NAME          start
token = 89 ln=    4 LPAREN
token = 90 ln=    4 RPAREN
token = 19 ln=    4 EQ
token =  6 ln=    4 VALOF
token = 79 ln=    5 LSECT
token = 65 ln=    5 LET
token =  2 ln=    5 NAME          a
token = 19 ln=    5 EQ
token =  1 ln=    5 NUMBER        12
token = 65 ln=    6 LET
token =  2 ln=    6 NAME          b
token = 19 ln=    6 EQ
token =  1 ln=    6 NUMBER        24
token = 44 ln=    7 RESULTIS
token =  2 ln=    7 NAME          a
token = 15 ln=    7 DIV
token = 89 ln=    7 LPAREN
token =  1 ln=    7 NUMBER        2
token = 14 ln=    7 MUL
token =  2 ln=    7 NAME          a
token = 18 ln=    7 SUB
token =  2 ln=    7 NAME          b
token = 90 ln=    7 RPAREN
token = 17 ln=    7 ADD
token =  2 ln=    7 NAME          f
token = 89 ln=    7 LPAREN

```

```

token = 2 ln=    7 NAME          b
token = 90 ln=   7 RPAREN
token = 80 ln=   8 RSECT
token = 94 ln=   9 EOF
0.010>

```

If we give the compiler the `tree` option, it will output the parse tree of the program being compiled as shown in the following example.

```

0.000> type tst.b
GLOBAL { start:1; f:300 }

LET start() = VALOF
{ LET a = 12
  LET b = 24
  RESULTIS a/(2*a-b) + f(b)
}
0.000> bcpl tst.b tree

BCPL (10 Oct 2014) with simple floating point
Parse Tree
GLOBAL  tst.b[1]
*-CONSTDEF  tst.b[1]
! *-CONSTDEF  tst.b[1]
! ! *-Nil
! ! *-NAME: f
! ! *-NUM: 300
! *-NAME: start
! *-NUM: 1
*-LET  tst.b[3]
*-FNDEF  tst.b[3]
! *-NAME: start
! *-Nil
! *-VALOF
!   *-LET  tst.b[4]
!     *-VALDEF  tst.b[4]
!       ! *-NAME: a
!       ! *-NUM: 12
!     *-LET  tst.b[5]
!       *-VALDEF  tst.b[5]
!         ! *-NAME: b
!         ! *-NUM: 24
!       *-RESULTIS  tst.b[6]
!         *-ADD
!         *-DIV

```

```

!          ! *-NAME: a
!          ! *-SUB
!          !   *-MUL
!          !   ! *-NUM: 2
!          !   ! *-NAME: a
!          !   *-NAME: b
!          *-FNAP
!          *-NAME: f
!          *-NAME: b
*-Nil
OCODE size:   54/200000
0.010>

```

This aids the debugging of the syntax analyser and users will sometimes use it to check their understanding of the relative precedence of expression operators.

The interface between the translation phase and the codegenerator is an intermediate code called OCODE, and running the compiler without telling it where to send the compiled code causes it to create a file of OCODE. This is just a sequence of numbers which can be made more readable using the `procode` command.

```

0.000> type tst.b
GLOBAL { start:1; f:300 }

```

```

LET start() = VALOF
{ LET a = 12
  LET b = 24
  RESULTIS a/(2*a-b) + f(b)
}
0.000> bcpl tst.b

```

BCPL (10 Oct 2014) with simple floating point

```

OCODE size:   54/200000
0.020> type ocode
 110 2 118 1 5 115 116 97 114 116 119 3 100 12 116 100
 24 116 98 3 98 3 100 2 14 98 4 18 15 115 9 98
 4 99 300 10 6 17 120 115 4 115 3 125 115 3 114 2
 116 68 1 1 1
0.010> procode
Converting ocode to *
JUMP L2
ENTRY L1 5 's' 't' 'a' 'r' 't'
SAVE 3
LN 12
STORE

```

```

LN 24
STORE
LP 3
LP 3
LN 2
MUL
LP 4
SUB
DIV
STACK 9
LP 4
LG 300
FNAP 6
ADD
FNRN
STACK 4
STACK 3
ENDPROC
STACK 3
LAB L2
STORE
GLOBAL 1
      1  L1

```

```

Conversion complete
0.000>

```

There are also various built-in aids to help debug the codegenerator. For instance the codegenerator can trace its generation of Cintcode instructions as in the following.

```

0.000> type tst.b
GLOBAL { start:1; f:300 }

LET start() = VALOF
{ LET a = 12
  LET b = 24
  RESULTIS a/(2*a-b) + f(b)
}
0.000> bcpl tst.b to junk d1

```

BCPL (10 Oct 2014) with simple floating point

```

0: DATAW #x00000000
4: DATAW #x0000DFDF
8: DATAW #x6174730B

```

```

12: DATAW #x20207472
16: DATAW #x20202020
// Entry to:  start
20: L1:
20:     L   12
22:     SP3
23:     L   24
25:     SP4
26:     XCH
27:     L2
28:     MUL
29:     LP4
30:     SUB
31:     LP3
32:     XCH
33:     DIV
34:     SP5
35:     LP4
36:     K6G1  44
38:     AP5
39:     RTN
40: L2:
40: DATAW #x00000000
44: DATAW #x00000001
48: DATAW #x00000014
52: DATAW #x0000012C
Code size =    56 bytes of 32-bit little ender Cintcode
0.020>

```

4.37.2 Using the interactive debugger

The BCPL Cintcode System has a built-in interactive debugger that can be invoked in various ways. One common way is when the running program tries to perform an operation that is not permitted, such as division by zero, or trying to call a global function that has not been defined. Both of these faults occur in the following program.

```

GLOBAL { start:1; f:300 }

LET start() = VALOF
{ LET a = 12
  LET b = 24
  RESULTIS a/(2*a-b) + f(b)
}

```

We can compile and test this program as follows.

```
solestreet:$ cd ~/distribution/BCPL/bcplprogs/tests/
solestreet:$ cintsys

BCPL 32-bit Cintcode System (21 Oct 2015)
0.000> c b tst
bcpl tst.b to tst hdrs BCPLHDRS t32

BCPL (10 Oct 2014) with simple floating point
Code size = 56 bytes of 32-bit little ender Cintcode
0.020> tst

!! ABORT 5: Division by zero
* c

!! ABORT 4: G300 unassigned
*
```

As can be seen when a fault is detected, the program is suspended with an indication of the error, and is left in the debugger waiting for the user to enter a debugging command. The first fault detected was **Division by zero** and when execution was resumed by the `c` command, the system discovers that the function `f` had not been defined.

A useful debugging command is `?` which outputs the list of available debugging commands.

```
* ?
?          Print list of debug commands
Gn Pn Rn Vn      Variables
G  P  R  V      Pointers
123 #o377 #FF03 'c  Constants
*e /e %e +e -e |e &e ^e  Dyadic operators
!e             Subscription
< >           Shift left/right one place
$b $c $d $f $o $s $u $x  Set the print style
SGn SPn SRn SVn SAn     Store in variable
=             Print current value
Tn           Print n consecutive locations
I           Print current instruction
N           Print next instruction
D           Dump Cintcode memory to DUMP.mem
Q           Quit -- leave the cintpos system
M           Set/Reset memory watch address
B OBn eBn    List, Unset or Set breakpoints
```

```

X (G4B9C) Set breakpoint 9 at start of clihook
Z (P1B9C) Set breakpoint 9 at return of current function
C          Continue normal execution
\          Single step execute one Cintcode instruction
. ; [ ]   Move to current/parent/first/next coroutine
,         Move down one stack frame
*

```

To discover the functions that are currently active, we can backtrack down the runtime stack by typing dot (.) followed by comma (,) a few times. resulting in the following output.

```

* . 12377: Coroutine: clihook Parent 8431 Stack 13/50000
* 12393: #G300# 24 #xABCD1234 #xABCD1234 #xABCD1234
* #xABCD1234 #xABCD1234 #xABCD1234 #xABCD1234 #xABCD1234
* #xABCD1234 #xABCD1234 #xABCD1234 #xABCD1234 #xABCD1234
* #xABCD1234 #xABCD1234 #xABCD1234 #xABCD1234 #xABCD1234
* , 12387: start 12 24 0
* , 12383: clihook 0
* , 12377: #StackBase# clihook 50000 12377
* , Base of stack
*

```

This shows that we are currently in a coroutine whose main function is `clihook` called from a coroutine whose stack is at 8431. The current coroutine has a stack size of 50000 words of which only 13 words has been used. The name of the function that was running when the fault occurred appears as `#G300#` since the function `f` has not been defined. Its first argument of the call is 24 being the current value of `b`. When coroutines are created their stacks are initialised with the special (recognisable) hex constant `ABCD1234`.

At the next level out we have the function `start` and can see that its first two local variables held 12 and 24 corresponding to variables `a` and `b` followed by an anonymous result 0. The next function down is called `clihook` and below that is the base of the stack.

The debugging command `g` gives us the address of the global vector and this can be output using `=`. We can also output several locations of memory using the `t` command, as shown below.

```

* g= 8943
* gt50

G 0: 1000 start stop sys clihook
G 5: muldiv changeco 12375 12375 100
G 10: -1 #G011# 9953 11025 0

```



```

G 15:      level      longjump      createco      deleteco      callco
G 20:      cwait      resumeco      initco        startco       globin
G 25:      getvec      rdargs2       freevec       abort         #G029#
G 30:      packstring unpac'tring   getword       putword       randno
G 35:      setseed      sardch        sawrch        rdch          binrdch
G 40:      unrdch      wrch          binwrch       deplete      readwords
G 45:      writewords  #G046#       splitname     findinput    findoutput
*

```

The default printing style usually outputs values as decimal numbers unless they appear to be entry points to BCPL functions. Function names are given where possible (possibly shortened as for `unpackstring`, above). Uninitialised global variables are given special values that allow the debugger to output values such as `#G011#` or `#G046#`. Large values are often output in hexadecimal. Several other printing styles `$b` `$c` `$d` `$f` `$o` `$s` `$u` `$x` are available.

```
* $x gt50
```

```

G 0:      000003E8      0000C11C      00004EFC      00007754      00004F44
G 5:      0000777C      00007768      00003057      00003057      00000064
G 10:     FFFFFFFF      8F8F000B      000026E1      00002B11      00000000
G 15:     00004F88      00004FA0      000064D4      00006528      000065D0
G 20:     00006618      000065F0      00006638      00006664      00006D98
G 25:     00006CEC      00005EE8      00006D2C      00004F70      8F8F001D
G 30:     00005D60      00005D40      00006BF0      00006C10      00005CE4
G 35:     00005D0C      00004FBC      00004FD0      0000501C      00005080
G 40:     000050E0      0000510C      0000517C      000054F4      000052FC
G 45:     00005358      8F8F002E      00006F14      0000551C      00005554
*

```

We can disassemble Cintcode compiled code using the `i` and `n` commands. As an example, the compilation of the function `start` is as follows.

```

* $f
* g1=      start
* i 49436:      L 12
* n 49438:      SP3
* n 49439:      L 24
* n 49441:      SP4
* n 49442:      XCH
* n 49443:      L2
* n 49444:      MUL
* n 49445:      LP4
* n 49446:      SUB
* n 49447:      LP3

```

```

* n 49448: XCH
* n 49449: DIV
* n 49450: SP5
* n 49451: LP4
* n 49452: K6G1 44
* n 49454: AP5
* n 49455: RTN
*

```

This shows that 12 is copied into the third word relative to the P pointer corresponding to local variable `a` and 24 is copied to the fourth word for `b`. This is followed by the compilation of $a/(2*a-b) + f(b)$ followed by RTN to return from `start`.

The debugger is part of the BCPL Cintcode system and so is always available. It can be entered from the command language interpreter using the `abort` command, as in:

```
0.000> abort
```

```
!! ABORT 99: User requested
*
```

At first sight this may not seem useful but it allows the `x` command set a breakpoint in `clihook` which is within the resident library `blib`. This function is used by the command language interpreter to call `start` of any command is executed. To demonstrate the use of this breakpoint, we will consider the compilation of the `echo` command. It is normally compiled as follows:

```
solestreet:$ cd ~/distribution/BCPL/cintcode
solestreet:$ cintsys
```

```
BCPL 32-bit Cintcode System (21 Oct 2015)
```

```
0.000> bcpl com/echo.b to junk
```

```
BCPL (10 Oct 2014) with simple floating point
Code size = 244 bytes of 32-bit little ender Cintcode
0.030>
0.000> junk hello
hello
0.010>
```

But if we set a breakpoint in `clihook` before performing the compilation the following happens.

```
0.000> abort
```

```
!! ABORT 99: User requested
* x
Breakpoint 9 at start of clihook
```

```
0.010> bcpl com/echo.b to junk
```

```
!! BPT 9:          clihook
   A=              0 B=              0 20292:   K4G  1
*
```

Here, we hit breakpoint 9 which is the first instruction of `clihook`, namely `K4G 1`, which calls `global 1` (the function `start`) of the BCPL compiler. This happens after the BCPL compiler has been loaded into memory and initialised. We can look at the compiler's global variables, set a break point at the start of the function `rcom` and let the compiler continue to run until it reaches this point.

```
* g+260t40
```

```
G 260:      #G260#      #G261#      #G262#      rdtag  performget
G 265:      lex        dsw  decls'words  #G268#  lookupword
G 270:  eqloo'pword    rch      #G272#      #G273#      #G274#
G 275:      #G275#      wrchbuf  #G277#      #G278#      #G279#
G 280:      #G280#      #G281#  rdblockbody  rdsect  rnamelist
G 285:      rname      rdef        rcom      rdcdefs  formtree
G 290:      synerr     opname      rexpulist  rdseq    mk1
G 295:      mk2        mk3        mk4        mk5     mk6
```

```
* g287b1
```

```
* b
```

```
1:          rcom
9:          clihook
```

```
* c
```

```
BCPL (10 Oct 2014) with simple floating point
```

```
!! BPT 1:          rcom
   A=              22868 B=              36 61132:   LF$ 60412
*
```

At this point the compiler has begun to compile `com/echo.b` and has stopped just before syntax analysing a command. At this moment we can see a rather more interesting backtrace of the run time stack using `dot` and `comma` as before.

```

* . 22667: Coroutine: clihook Parent 8427 Stack 395/50000
* 22980: rcom 22868 36 51 32
* lex 91940 51542 lookupword 275772
* 8 0 4 9 8
* 107 4 91984 55106 50
* , 22971: rbexp 0 6 91884 59039
* lex 91904
* , 22967: rexp 0
* , 22963: rnexp 0
* , 22950: rdef -1 274951 5 0
* 91800 60114 lex 91828 53346
* rch
* , 22942: rdblockbody -1 91712 58252 0
* 5
* , 22928: rdblockbody -1 91656 58252 272899
* 1048790 67 91712 58290 rdsect
* rdcdefs 19
* , 22914: rdblockbody -1 91600 58252 274946
* 1048601 68 91656 58290 rdsect
* rdcdefs 45
* , 22900: rdblockbody -1 91544 57622 274962
* 1048588 67 91600 58290 rdsect
* rdcdefs 19
* , 22890: rprog 40 274987 91560 57894
* rbexp 40 274987
* , 22886: formtree 0
* , 22677: start 200000 22683 12676 22704
* 22707 0 0 0 0
* 0 0 0 0 0
* 0 0 0 0 0
* , 22673: clihook 0
* , 22667: #StackBase# clihook 50000 22667
* , Base of stack
*

```

We can view the current breakpoints, clear them using the `b` command, and resume execution of the compilation, using `c`.

```

* b
1: rcom
9: clihook
* 0b1 0b9
* b
*
* c

```

```
Code size = 244 bytes of 32-bit little ender Cintcode
0.090>
```

The third, and possibly the most useful, way to enter the debugger is to explicitly call `debug` usually after outputting some useful information using `writeln` or `sawriteln`. As an illustration of this method we will use the program `BCPL/bcplprogs/primes.b` which is as follows:

```
GET "libhdr"

GLOBAL { count: ug }

MANIFEST { upb = 541 }
//MANIFEST { upb = 9999 }
//MANIFEST { upb = 1000000 }

LET start() = VALOF
{ LET isprime = getvec(upb)
  LET bigp = 0
  count := 0

  FOR i = 2 TO upb DO isprime!i := TRUE // Until proved otherwise.

  FOR p = 2 TO upb IF isprime!p DO
  { LET i = p*p // Smaller multiples of p are already crossed out.
    UNTIL i>upb DO { isprime!i := FALSE; i := i + p }
    out(p)
    bigp := p
  writeln("*np=%i3 bigp=%n isprime=%i6*n", p, bigp, isprime)
  abort(1000)
  }

  writeln("*n*nLargest prime %n*n", bigp)
  writes("*nend of output*n")
  freevec(isprime)
  RESULTIS 0
}

AND out(n) BE
{ IF count MOD 10 = 0 DO writeln("*n%i5: ", count+1)
  writeln(" %i5", n)
  count := count + 1
}
```

We can compile and run this program as follows:

```
solestreet:$ cintsys
```

```
BCPL 32-bit Cintcode System (21 Oct 2015)
```

```
0.000> c b primes
```

```
bcpl primes.b to primes hdrs BCPLHDRS t32
```

```
BCPL (10 Oct 2014) with simple floating point
```

```
Code size = 260 bytes of 32-bit little ender Cintcode
```

```
0.030> primes
```

```
1: 2
```

```
p= 2 bigp=2 isprime= 62457
```

```
!! ABORT 1000: Unknown fault
```

```
* 62457sv1
```

```
* v1t40
```

A62457:	#xABCD1234	#xABCD1234	-1	-1	0
A62462:	-1	0	-1	0	-1
A62467:	0	-1	0	-1	0
A62472:	-1	0	-1	0	-1
A62477:	0	-1	0	-1	0
A62482:	-1	0	-1	0	-1
A62487:	0	-1	0	-1	0
A62492:	-1	0	-1	0	-1

```
* c
```

```
3
```

```
p= 3 bigp=3 isprime= 62457
```

```
!! ABORT 1000: Unknown fault
```

```
* v1t40
```

A62457:	#xABCD1234	#xABCD1234	-1	-1	0
A62462:	-1	0	-1	0	0
A62467:	0	-1	0	-1	0
A62472:	0	0	-1	0	-1
A62477:	0	0	0	-1	0
A62482:	-1	0	0	0	-1
A62487:	0	-1	0	0	0
A62492:	-1	0	-1	0	0

```
* c
```

```
5
```

```
p= 5 bigp=5 isprime= 62457
```

```
!! ABORT 1000: Unknown fault
```

```

* v1t40
A62457:  #xABCD1234  #xABCD1234      -1      -1      0
A62462:          -1          0      -1      0      0
A62467:          0          -1      0      -1      0
A62472:          0          0      -1      0     -1
A62477:          0          0      0      -1      0
A62482:          0          0      0      0     -1
A62487:          0          -1      0      0      0
A62492:          0          0      -1      0      0
* q

solestreet:$

```

Notice that it is convenient to store the pointer to the vector `isprime` in variable `V1` (using `62457sv1`). We can then look at its state after various iterations of the `FOR` loop. Notice that when `p=5` all multiples of the primes 2, 3 and 5 have been crossed out in `isprime`. Note that `TRUE` and `FALSE` are represented by `-1` and `0`, respectively. So as the program proceeds more elements of `isprime` are set to `FALSE`.

If we comment out the two lines of debugging code, and re-compile and run the program, the output is as follows.

```

0.000> c b primes
bcpl primes.b to primes hdrs BCPLHDRS t32

BCPL (10 Oct 2014) with simple floating point
Code size = 220 bytes of 32-bit little ender Cintcode
0.030> primes

  1:    2    3    5    7   11   13   17   19   23   29
 11:   31   37   41   43   47   53   59   61   67   71
 21:   73   79   83   89   97  101  103  107  109  113
 31:  127  131  137  139  149  151  157  163  167  173
 41:  179  181  191  193  197  199  211  223  227  229
 51:  233  239  241  251  257  263  269  271  277  281
 61:  283  293  307  311  313  317  331  337  347  349
 71:  353  359  367  373  379  383  389  397  401  409
 81:  419  421  431  433  439  443  449  457  461  463
 91:  467  479  487  491  499  503  509  521  523  541

Largest prime 541

```

```

End of output
0.000>

```

4.37.3 Summary

A brief summary of the previous few sections is as follows:

- 1 Write the program with extreme care and proof read it very carefully.
- 2 Create and study the cross reference listing, paying particular attention to global variable numbers, arguments of function calls and definitions, and the use of pointers and subscripts.
- 3 Program cautiously, including code to check the validity of variables, particularly pointers and array subscripts.
- 4 Add code to conditionally output some of the internal structures used in the program so that they can be checked.
- 5 Insert code to generate debugging output followed by calls of `abort`.
- 6 Debug the program by setting a breakpoint in `clihook`.
- 7 Use the debugger to check how much stack space has been used by the program's coroutines, since stack overflow normally causes the program to crash.

Young Persons Guide to BCPL Programming on the Raspberry Pi Part 2

by

Martin Richards

`mr@cl.cam.ac.uk`

`http://www.cl.cam.ac.uk/~mr10/`

Computer Laboratory
University of Cambridge

Revision date: Tue Oct 23 16:58:19 BST 2018

Chapter 5

Interactive Graphics in BCPL using SDL

5.1 Introduction

If your system does not already have the SDL libraries and header files installed, you should fetch them using commands such as the following.

```
sudo apt-get update
sudo apt-get install libsdl1.2-dev libsdl-image1.2-dev
sudo apt-get install libsdl-mixer1.2-dev libsdl-ttf2.0-dev
```

The `apt-get update` command stops some annoying error messages being generated by the two `install` commands.

As a test to see if they have been installed examine the directory `/usr/include/SDL`. It should contain several files relating to SDL.

Having installed the SDL libraries you should rebuild the BCPL system telling it to use the libraries. To do this type the following.

```
cd ~/distribution/BCPL/cintcode
make clean
make -f MakefileRaspiSDL
```

This should rebuild the BCPL system from its source incorporating and interface with SDL.

Although all the programs in this chapter can be controlled from the keyboard, you may find it useful to plug a USB joystick into your Raspberry Pi. I bought a Logitech Attack 3 Joystick which is cheap, well made and works well. It is shown below. Although it provides elevator, aileron and throttle control together with

11 buttons, it does not provide a convenient rudder control, so you might wish to buy a more expensive model.

To test whether you have installed the SDL graphics library correctly, try compiling and running the demonstration program `bcplprogs/raspi/engine.b` by typing the following commands.

```
cd ~/distribution/BCPL/bcplprogs/raspi
cintsys
c b engine
engine
```

This should create and display the following window for about 20 seconds.

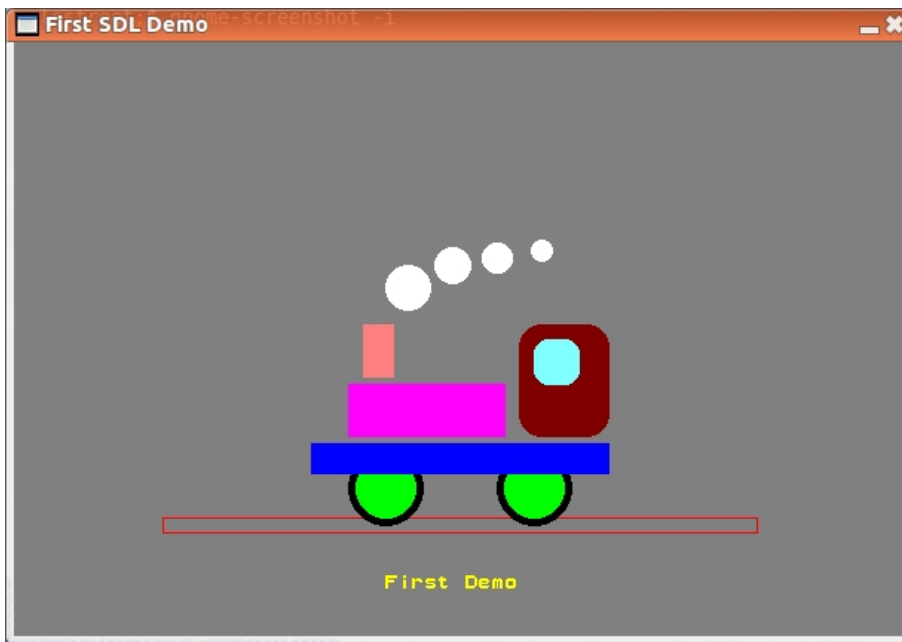

The program starts as follow.

```
GET "libhdr"
GET "sdl.h"
GET "sdl.b"           // Insert the library source code
.
GET "libhdr"
GET "sdl.h"
```

The first four lines consisting of three `GET` directives and a dot, cause a BCPL interface to the SDL library to be compiled as a separate section at the head of the program. The source is in `cintcode/g/sdl.b` and it uses a header file called `cintcode/g/sdl.h`. In due course you should look at these files to see what is

provided, but that can wait. The program goes on to declare some global variables that will be used to hold the various colours.

```
GLOBAL {
  done:ug

  col_black
  col_blue
  col_green
  col_yellow
  col_red
  col_magenta
  col_cyan
  col_white
  col_darkred
  col_gray
  col_lightyellow
  col_lightred
}
```

The rest of the program just contains the definition of the main program `start`, and is as follows.

```
LET start() = VALOF
{ initsdl()
  mkscreen("First SDL Demo", 600, 400)

  col_black      := maprgb( 0,  0,  0)
  col_blue       := maprgb( 0,  0, 255)
  col_green      := maprgb( 0, 255,  0)
  col_yellow     := maprgb( 0, 255, 255)
  col_red        := maprgb(255,  0,  0)
  col_magenta    := maprgb(255,  0, 255)
  col_cyan       := maprgb(255, 255,  0)
  col_white      := maprgb(255, 255, 255)
  col_darkred    := maprgb(128,  0,  0)
  col_gray       := maprgb( 70,  70,  70)
  col_lightyellow := maprgb(128, 255, 255)
  col_lightred   := maprgb(255, 128, 128)

  fillsurf(col_gray)

  setcolour(col_cyan)
  plotf(250, 30, "First Demo")
```

```

setcolour(col_red)           // Rails
moveto( 100, 80)
drawby( 400, 0)
drawby( 0, -10)
drawby(-400, 0)
drawby( 0, 10)

setcolour(col_black)        // Wheels
drawfillcircle(250, 100, 25)
drawfillcircle(350, 100, 25)
setcolour(col_green)
drawfillcircle(250, 100, 20)
drawfillcircle(350, 100, 20)

setcolour(col_blue)         // Base
drawfillrect(200, 110, 400, 130)

setcolour(col_magenta)      // Boiler
drawfillrect(225, 135, 330, 170)

setcolour(col_darkred)      // Cab
drawfillroundrect(340, 135, 400, 210, 15)
setcolour(col_lightyellow)
drawfillroundrect(350, 170, 380, 200, 10)

setcolour(col_lightred)     // Funnel
drawfillrect(235, 175, 255, 210)

setcolour(col_white)        // Smoke
drawfillcircle(265, 235, 15)
drawfillcircle(295, 250, 12)
drawfillcircle(325, 255, 10)
drawfillcircle(355, 260, 7)

updatescreen() //Update the screen
sdldelay(20_000) //Pause for 20 secs
closesdl() //Quit SDL

RESULTIS 0
}

```

The call `initsdl()` initialises the SDL system allowing the program to create a window, draw a picture in it, interact with the keyboard, mouse, and joystick, if any, and even generate sounds. The call of `mkscreen` creates a window that is 600 pixels wide and 400 pixels high. It is given the title `First SDL Demo`.

Then follows a sequence of calls to `maprgb` to create values representing colours in the pixel format used by the system. These calls can only be made after `mkwindow` has been called. There are several possible pixel formats and is more efficient to use the one that the system is currently using. It turns out that the pixel format on my laptop is different from the one used by the Raspberry Pi.

The next call `fillscreen(col.darkgreen)` fills the entire window with the specified colour. The call `setcolour(...)` selects the colour to use in subsequent drawing operations. The first of which is to draw the string `First Demo` starting 250 pixels from the left of the window and 30 pixels from the bottom. The convention often adopted in windowing systems is to measure the vertical displacement from the top, but I have adopted the convention that the vertical displacement increases as you move upwards as is typical when drawing graphs on graph paper. If my choice turns out to be too problematic, I will change it and all your pictures will suddenly be upside down.

Lines can be drawn in the selected colour by calls such as `moveto`, `drawto`, `moveby` and `drawby`, which each take a pair of arguments giving either the absolute or relative pixel locations. More complicated shapes can be drawn using functions such as `drawcircle(ox, oy, r)`, `drawfillcircle(ox, oy, r)`, `drawrect(x1, y1, x2, y2)`, `drawfillrect(x1, y1, x2, y2)`, `drawroundrect(x1, y1, x2, y2, r)` and `drawfillroundrect(x1, y1, x2, y2, r)`. In these calls `ox` and `oy` are the coordinates of the centre of the circle and `r` is its radius. If the function name includes `fill`, the edge and inside of the shape is filled with the selected colour, otherwise only the edge is drawn. Rectangles can have rounded corners with a radius in pixels given by `r`.

After drawing the picture it can be sent to the display hardware by the call `updatescreen()`. The call `sdldely(20_000)` causes a real time delay of 20 seconds so that the image can be viewed, and the final call `closesdl()` causes the graphics system to close down.

5.2 The dragon curve

This next demonstration draws the well known dragon curve. The idea is simple. To draw the curve from point *A* to *B*, if the distance is less than a certain limit, the curve is just a straight line from *A* to *B*, otherwise a detour is made travelling along two sides of a square whose diagonal is *AB*. If the sides of the square is still too long, detours are again taken, and so on. The detours alternate in direction, the first being to the right, the second being to the left and so on. Surprisingly this generates a rather beautiful picture. The following program generates a dragon curve containing 1024 short line segments with a short delay as each is drawn so you can see the picture being built up. The program is in the file `bcplprogs/raspi/dragon.b` and is as follows.

```
GET "libhdr"
```

```

GET "sdl.h"
GET "sdl.b"
.
GET "libhdr"
GET "sdl.h"

GLOBAL {
  col_blue: ug
  col_white
  col_lightcyan
}

LET start() = VALOF
{ initsdl()
  mkscreen("Dragon Curve", 600, 600)

  col_blue      := maprgb( 0,  0, 255)
  col_white     := maprgb(255, 255, 255)
  col_lightcyan := maprgb(255, 255, 64)

  fillscreen(col_blue)

  setcolour(col_lightcyan)
  plotf(240, 50, "The Dragon Curve")

  setcolour(col_white)
  moveto(260, 200)
  dragon(1024, 6)

  updatescreen()
  slddelay(20_000)
  closesdl()
  RESULTIS 0
}

AND gray(n) = n XOR n>>1

AND bits(w) = w=0 -> 0, 1 + bits(w & w-1)

AND dragon(n, size) BE FOR i = 0 TO n-1 DO
{ LET dir = bits(gray(i))
  SWITCHON dir & 3 INTO
  { CASE 0: drawby( size,  0); ENDCASE // Right
    CASE 1: drawby(  0, size); ENDCASE // Up
    CASE 2: drawby(-size,  0); ENDCASE // Left
  }
}

```



```

CASE 3: drawby( 0, -size); ENDCASE // Down
}
updatescreen() // Show the curve as it is drawn
sdldelay(20)
}

```

When this program runs, it creates a window like the following.

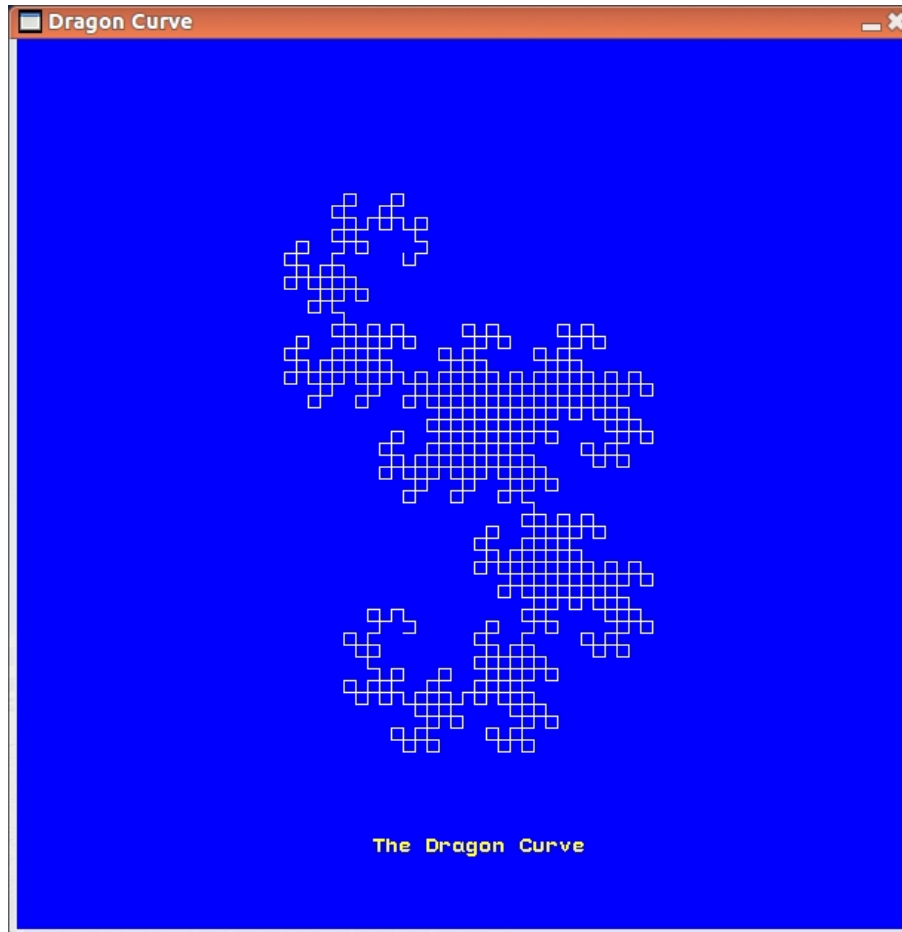

The program uses a cunning trick to determine the direction the i^{th} line segment based on the number of one bits in the gray code representation of i . The gray code corresponding to the binary number 0110 is shown as follows.

number in binary	0 1 1 0
corresponding gray code	1 0 1

Notice that each digit of the gray code is computed by comparing adjacent digits of the number. The gray code digit is 0 if the adjacent digits are the same, otherwise it is a 1. This conversion is done by the function `gray` whose body is `n XOR (n>>1)`. The gray codes for the integers 000 to 111 are shown in the following table.

n	n XOR (n>>1)	ones	direction
000	000	0	right
001	001	1	up
010	011	2	left
011	010	1	up
100	110	2	left
101	111	3	down
110	101	2	left
111	100	1	up

Notice that Gray code has the property that only one digit changes as you move from one number to the next. The function `bits` counts the number of ones in its argument using a trick involving the expression `w&(w-1)` as explained on page 50. The sequence of counts for consecutive Gray codes can be regarded as a sequence of directions taken as a curve is drawn, and the following diagrams help to show why this scheme generates the dragon curve.

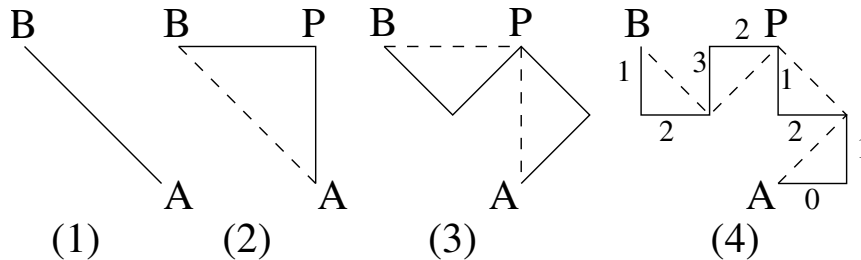

Notice that the shape of the lines from P to B in diagram (4) is the same as that from A to P, but rotated clockwise through 90 degrees about P and drawn backward.

5.3 The Game of life

In 1970 John Conway invented a cellular automaton he called The Game of Life. It consists of a 2D array of cells, each of which can be alive or dead. At every clock tick a new generation is formed by applying the following rules. A live cell remains alive if exactly 2 or 3 of its eight immediate neighbours are alive, otherwise it dies. A dead cell becomes alive only if exactly 3 of its eight immediate neighbours are alive. This automaton has some extraordinary properties causing considerable interest around the world. For more details, look it up on the internet.

The program `bcplprogs/raspi/life.b` is my implementation of the game. It uses a bit map `map1` to hold the state of the cells, generating the next state in `map2`. You may find the implementation interesting since it deals with 32 cells at a time using efficient bit pattern operations. This approach is probably most

suitable when there are a high proportion of live cells. Although the program is not described here, it is explained in detail in comments in the code. The cunning way in which the number of live cells is calculated is worth looking at.

When you run the program you can specify the size of the rectangular array of cells and the size of the displayed window of cells at its centre. The `t` option specifies a test number. If `t=0`, the default setting, the initial state consists of a rectangle of random cells surrounded by dead cells. Other values of `t` setup simple special cases. A typical screenshot resulting from the command:

```
life xs 400 ys 400
```

is

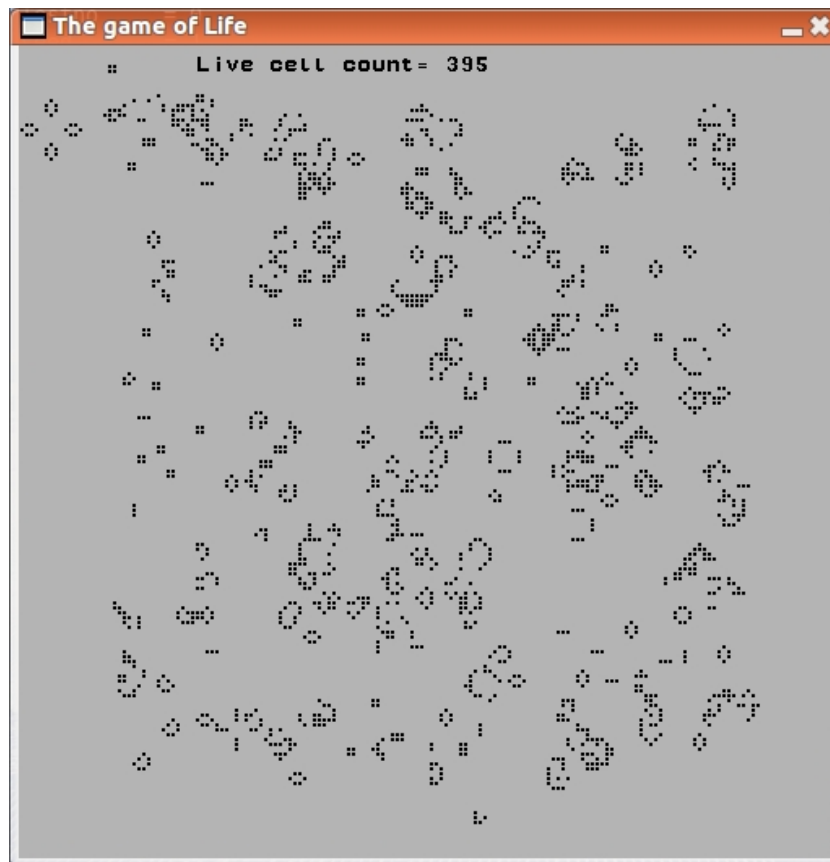

At the bottom of this image there is a group of five live cells called a glider that slowly moves down and to the left. If you execute life using the command: `life t 3` you will see a remarkable set of live cells that will continually creates gliders. You might find it interesting to explore what happens when two gliders collide either head on or at right angles. The effect depends on the relative phase and position of the two gliders.

5.4 Collatz Revisited

The program described in this section concerns the Collatz Conjecture which was introduced in Section 4.16 but has been delayed until this point since it generates a graphical image. It draws a graph showing, on the vertical axis, the length in the range 1 to 250 of the Collatz sequences for starting values in the range 1 to 10000 placed on the horizontal axis. The program is called `collatzgraph.b` and is as follows.

```

GET "libhdr"
GET "sdl.h"
GET "sdl.b"
.
GET "libhdr"
GET "sdl.h"

MANIFEST {
  nlim = 10000
  clim = 250
}

GLOBAL {
  col_red: ug
  col_green
  col_blue
  col_lightgray
  col_black
}

LET start() = VALOF
{ initsdl()
  mkscreen("Collatz Diagram", 700, 500)

  col_red      := maprgb(180, 0, 0)
  col_green    := maprgb( 0, 255, 0)
  col_blue     := maprgb( 0, 0, 255)
  col_lightgray := maprgb(180, 180, 180)
  col_black    := maprgb( 0, 0, 0)

  fillsurf(col_lightgray)

  // Draw the axes
  setcolour(col_black)

  cmoveto( 0, 0)

```

```

cdrawto(nlim, 0)
cdrawto(nlim, clim)
cdrawto( 0, clim)
cdrawto( 0, 0)

FOR x = 1 TO nlim DO
{ LET y = try(x)
  TEST y>=0
  THEN setcolour(col_red)
  ELSE { setcolour(col_blue)
        y := -y
      }
  cdrawpoint(x, y)
  updatescreen()
}

sdldelay(20_000)
closesdl()
RESULTIS 0
}

AND cdrawpoint(x,y) BE
{ // Convert to screen coordinates
  LET sx = 10 + muldiv(screenxsize-20, x, nlim)
  LET sy = 10 + muldiv(screenysize-20, y, clim)
  drawfillcircle(sx, sy, 1)
}

AND cmoveto(x,y) BE
{ // Convert to screen coordinates
  LET sx = 10 + muldiv(screenxsize-20, x, nlim)
  LET sy = 10 + muldiv(screenysize-20, y, clim)
  moveto(sx, sy)
}

AND cdrawto(x,y) BE
{ // Convert to screen coordinates
  LET sx = 10 + muldiv(screenxsize-20, x, nlim)
  LET sy = 10 + muldiv(screenysize-20, y, clim)
  drawto(sx, sy)
}

AND try(n) = VALOF
{ LET count = 0
  LET lim = (maxint-1)/3

```

```

{ count := count+1
  IF n=1 RESULTIS count
  TEST n MOD 2 = 0
  THEN { n := n/2
        }
  ELSE { IF n > lim RESULTIS -count
        n := 3*n+1
        }
} REPEAT
}

```

When this program is run it generates the following window.

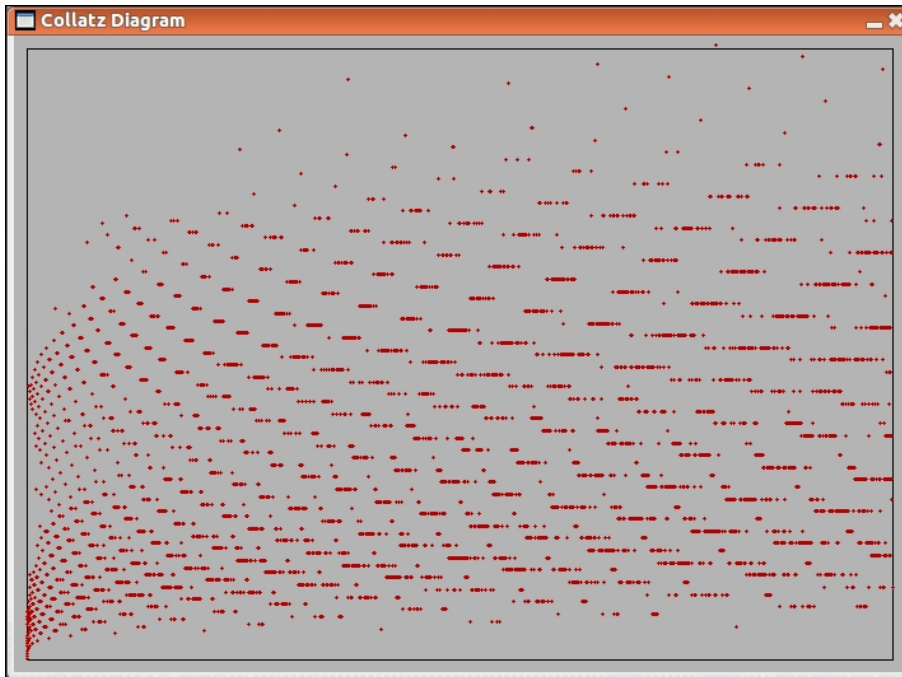

5.5 sdlinfo.b

This section presents a simple program that displays some details of the graphics system. It also displays information about any joysticks that are connected to the system. The program is called `sdlinfo.b` and is as follows.

```

/*
This program outputs some information about the current SDL interface.

```

```

Implemented by Martin Richards (c) February 2013

```

```

*/

```



```

    "palette=%n bitsperpixel=%n bytesperpixel=%n",
    palette, bitsperpixel, bytesperpixel)
plotf(30, maxy-120,
    "Rmask=%8x Gmask=%8x Bmask=%8x Amask=%8x",
    Rmask, Gmask, Bmask, Amask)
plotf(30, maxy-140,
    "Rshift=%n Gshift=%n Bshift=%n Ashift=%n",
    Rshift, Gshift, Bshift, Ashift)
plotf(30, maxy-160,
    "Rloss=%n Gloss=%n Bloss=%n Aloss=%n",
    Rloss, Gloss, Bloss, Aloss)
plotf(30, maxy-180,
    "colorkey=%8x alpha=%n",
    colorkey, alpha)

// Video info
plotf(20, maxy-220, "Video Info")
plotf(30, maxy-240,
    "videoflags=%8x blit_fill=%8x video_mem=%n",
    videoflags, blit_fill, video_mem)

{ LET n = sys(Sys_sdl, sdl_numjoysticks)
  plotf(20, maxy-280, "Number of joysticks %2i", n)
  FOR j = 0 TO n-1 DO
    { LET joystick = sys(Sys_sdl, sdl_joystickopen, j)
      LET axes = sys(Sys_sdl, sdl_joysticknumaxes, joystick)
      LET buttons = sys(Sys_sdl, sdl_joysticknumbuttons, joystick)
      LET hats = sys(Sys_sdl, sdl_joysticknumhats, joystick)
      plotf(20, maxy-300-80*j, "Joystick %n", j+1)
      plotf(30, maxy-320-80*j,
        "Number of axes %2i", axes)
      FOR a = 0 TO axes-1 DO
        plotf(250+60*a, maxy-320-80*j,
          "%i7", sys(Sys_sdl, sdl_joystickgetaxis, joystick, a))
      plotf(30, maxy-340-80*j,
        "Number of buttons %2i", buttons)
      FOR b = 0 TO buttons-1 DO
        plotf(250+20*b, maxy-340-80*j,
          "%i2", sys(Sys_sdl, sdl_joystickgetbutton, joystick, b))
      plotf(30, maxy-360-80*j,
        "Number of hats %2i", hats)
      FOR h = 0 TO hats-1 DO
        plotf(250+20*h, maxy-360-80*j,
          "%b4", sys(Sys_sdl, sdl_joystickgethat, joystick, h))
      sys(Sys_sdl, sdl_joystickclose, joystick)
    }
  }

```



```

    }
  }
}

AND processevents() BE WHILE getevent() SWITCHON eventtype INTO
{ CASE sdle_keydown:
  CASE sdle_quit:      done := TRUE
  DEFAULT:            LOOP
}

LET start() = VALOF
{ initsdl()
  mkscreen("SDL Info", 800, 500)

  done := FALSE

  UNTIL done DO
  { processevents()
    plotscreen()
    updatescreen()
    sdldelay(50)
  }

  writef("*nQuitting*n")
  closesdl()
  RESULTIS 0
}

```

The main function `start` initialises the SDL interface and then makes a window of size 800x500. It then enters an event loop which it repeatedly executes until `done` is set to `TRUE`. Within the event loop the call of `processevents` sets `done` to `TRUE` if any key is pressed or if the user clicks on the window's close button.

The call of `plotscreen` interrogates the SDL system and displays some of the information it obtains. It then displays axis, button and hat information about any joysticks that are attached to the system. The call `updatescreen()` sends the window to the display hardware. The loop ends by delaying for 50 milli-seconds.

5.6 Graphs

A useful aid to understanding a numerical function is to plot its graph. On graph paper the point (x, y) is located at a distance x along the horizontal (x -axis) and a distance y along the vertical (y -axis). The collection of points with

coordinates (x, x^2) gives a curve that shows how x^2 changes as we increase x . The following diagram shows the curves for the three functions $y = x^2$, $y = x^3 - x$ and $y = x^3 - x^2 - x$ displayed in red, green and blue, respectively. The program (bcplprogs/raspi/graph.b) to draw the graph is as follow.

```

GET "libhdr"
GET "sdl.h"
GET "sdl.b"
.
GET "libhdr"
GET "sdl.h"

GLOBAL {
  col_red: ug
  col_green
  col_blue
  col_lightgray
  col_black
}

LET start() = VALOF
{ initsdl()
  mkscreen("Three curves", 500, 500)

  col_red      := maprgb(255,  0,  0)
  col_green    := maprgb(  0, 255,  0)
  col_blue     := maprgb(  0,  0, 255)
  col_lightgray := maprgb(180, 180, 180)
  col_black    := maprgb(  0,  0,  0)

  fillsurf(col_lightgray)

  // We will use scales numbers with three digits after the
  // decimal point and the $x$ and $y$ ranges will both be
  // between -3.000 and +3.000

  // Draw the axes
  setcolour(col_black)
  FOR x = -3_000 TO 3_000 BY 1_000 DO
  { cmoveto(x, -3_000)
    cdrawto(x,  3_000)
  }
  FOR y = -3_000 TO 3_000 BY 1_000 DO
  { cmoveto(-3_000, y)
    cdrawto( 3_000, y)
  }
}

```

```

}

plotfn(f1, -3_000, 3_000, col_red)
plotfn(f2, -3_000, 3_000, col_green)
plotfn(f3, -3_000, 3_000, col_blue)

updatescreen()
sdldelay(20_000)
closesdl()
RESULTIS 0
}

AND plotfn(f, x1, x2, col) BE
{ setcolour(col)
  cmoveto(x1, f(x1))
  FOR i = 1 TO 100 DO
  { LET x = (x1*(100-i) + x2*i)/100
    cdrawto(x, f(x))
  }
}

AND f1(x) = x*x/3_000

AND f2(x) = f1(x)*x/3_000 - x

AND f3(x) = f1(x) - f2(x)

AND cmoveto(x,y) BE
{ // Convert to screen coordinates
  LET sx = screenxsize/2 + x/15
  LET sy = screenysize/2 + y/15
  moveto(sx, sy)
}

AND cdrawto(x,y) BE
{ // Convert to screen coordinates
  LET sx = screenxsize/2 + x/15
  LET sy = screenysize/2 + y/15
  drawto(sx, sy)
}

```

This program displays the following window for 20 seconds.

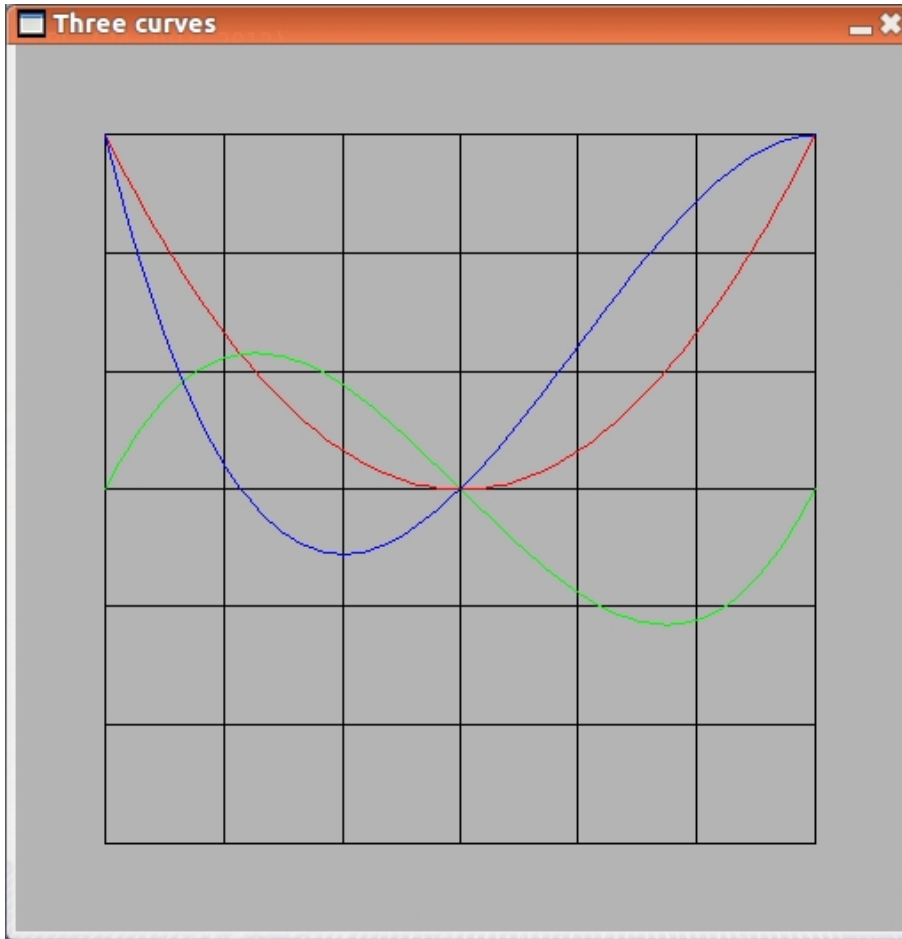

5.7 Gradients

The gradient of a function for a given value of x is a measure of how much it changes when x is changed by a tiny amount. Mathematically, we say that the gradient of $f(x)$ is the limit of $(f(x + dx) - f(x))/dx$ as dx becomes closer and closer to zero. Mathematicians call the gradient the differential of $f(x)$ and represent it using the notation:

$$\frac{d}{dx}f(x)$$

Luckily, for many simple functions there are simple formulae allowing us to compute the differential. For instance, consider the following program (bcplprogs/raspi/slope.b).

```
GET "libhdr"
```

```

// This program outputs the approximate slope of  $y = x^n$  for
// various values of  $x$  and  $n$ , using scaled numbers with 8 digits
// after the decimal point.

LET start() = VALOF
{ writef("      x      n      dx      slope      n**pow(x,n-1)*n*n")

  try( 1_12345678, 0); try( 1_12345678, 1); try( 1_12345678, 2)
  try( 1_12345678, 3); try( 1_12345678, 4)
  newline()
  try( 0_87654321, 0); try( 0_87654321, 1); try( 0_87654321, 2)
  try( 0_87654321, 3); try( 0_87654321, 4)
  newline()
  try(-0_12345678, 0); try(-0_12345678, 1); try(-0_12345678, 2)
  try(-0_12345678, 3); try(-0_12345678, 4)

  RESULTIS 0
}

AND try(x, n) BE
{ LET dx = 0_00010000
  LET slope = muldiv(pow(x+dx,n) - pow(x,n), 1_00000000, dx)
  writef("%11.8d %n %11.8d %11.8d %11.8d*n",
        x, n, dx, slope, n * pow(x, n-1))
}

AND pow(x, n) = VALOF
{ LET xn = 1_00000000
  FOR i = 1 TO n DO xn := muldiv(xn, x, 1_00000000)
  RESULTIS xn
}

```

When run, it outputs the following.

x	n	dx	slope	$n \cdot \text{pow}(x, n-1)$
1.12345678	0	0.00010000	0.00000000	0.00000000
1.12345678	1	0.00010000	1.00000000	1.00000000
1.12345678	2	0.00010000	2.24700000	2.24691356
1.12345678	3	0.00010000	3.78680000	3.78646539
1.12345678	4	0.00010000	5.67260000	5.67190692
0.87654321	0	0.00010000	0.00000000	0.00000000

```

0.87654321 1  0.00010000  1.00000000  1.00000000
0.87654321 2  0.00010000  1.75320000  1.75308642
0.87654321 3  0.00010000  2.30520000  2.30498397
0.87654321 4  0.00010000  2.69430000  2.69389072

-0.12345678 0  0.00010000  0.00000000  0.00000000
-0.12345678 1  0.00010000  1.00000000  1.00000000
-0.12345678 2  0.00010000 -0.24680000 -0.24691356
-0.12345678 3  0.00010000  0.04570000  0.04572471
-0.12345678 4  0.00010000 -0.00750000 -0.00752668

```

This seems to imply that

$$\frac{d}{dx}x^n = n \times x^{n-1}$$

We can convince ourselves that this is indeed correct by the following derivation.

$$\begin{aligned}
\frac{d}{dx}x^n &= \frac{((x+dx) \times (x+dx) \times \dots \times (x+dx)) - x^n}{dx} \\
&= \frac{x^n + n \times x^{n-1} dx + O(dx^2) - x^n}{dx} \\
&= \frac{n \times x^{n-1} dx + O(dx^2)}{dx} \\
&= n \times x^{n-1} + O(dx) \\
&= n \times x^{n-1}
\end{aligned}$$

where the notation $O(dx)$ stands for terms that all have dx as a factor, so tend to zero as dx becomes smaller and smaller.

Using this formula we can easily see that

$$\begin{aligned}
\frac{d}{dx} \left(\frac{x^n}{n!} \right) &= \frac{n \times x^{n-1}}{n!} \\
&= \frac{x^{n-1}}{(n-1)!}
\end{aligned}$$

This allows us to deduce a remarkable property of e^x , namely

$$\begin{aligned}
\frac{d}{dx} e^x &= \frac{d}{dx} \left(1 + x + \frac{x^2}{2!} + \frac{x^3}{3!} + \frac{x^4}{4!} + \dots \right) \\
&= 0 + 1 + x + \frac{x^2}{2!} + \frac{x^3}{3!} + \dots \\
&= e^x
\end{aligned}$$

5.8 Events

This section demonstrates how input from the keyboard, mouse and joystick can be handled. The program displays a coloured circle in a window. Its colour may be changed to red, green or blue by pressing R, G or B on the keyboard, or by buttons on the joystick. It can be moved up, down, left or right by pressing the arrow keys, and it may be dragged using the mouse with a mouse button pressed. It may also be moved using the joystick. You can exit from the program by pressing Q. The program (`bcplprogs/raspi/events.b`) starts as follows.

```

GET "libhdr"
GET "sdl.h"
GET "sdl.b"
.
GET "libhdr"
GET "sdl.h"

GLOBAL {
  done:ug
  xpos; ypos; xdot; ydot

  col_blue; col_green; col_red
  col_cyan; col_white; col_gray
}

LET start() = VALOF
{ initsdl()
  mkscreen("Events Test", 600, 400)
  runtest()
  closesdl()
  RESULTIS 0
}

```

As usual we insert a section containing the BCPL interface to the SDL library, and declare the global variables required by the program. The main function `start` initialises the SDL system and make a window of size 600 by 400 entitled `Events Test` before calling `runtest`, defined below, and the call `closesdl` closes down the SDL library.

```

AND runtest() = VALOF
{ // Declare a few colours in the pixel format of the screen
  col_blue      := maprgb( 0,  0, 255)
  col_green     := maprgb( 0, 255,  0)
  col_red       := maprgb(255,  0,  0)
}

```

```

col_cyan      := maprgb(255, 255,  0)
col_white     := maprgb(255, 255, 255)
col_gray      := maprgb(128, 128, 128)

fillscreen(col_gray)

xpos, ypos := 1000*screenxsize/2, 1000*screenysize/2
xdot, ydot := 0, 0
setcolour(col_red) // Set the initial circle colour
done := FALSE

UNTIL done DO
{ step()
  displayall()
  slddelay(20)
}

RESULTIS 0
}

```

`runtest` creates a few colours, fills the screen with a gray colour and initialises, `xpos`, `ypos`, `xdot`, `ydot` and `done`. The first two are scaled numbers with three digits after the decimal point representing the coordinates on the screen of the location of the small coloured circle. Mathematicians often use the notation \dot{x} and \dot{y} to represent the rate at which x and y change with time. In this program we use the names `xdot` and `ydot` to hold the rate of change of `xpos` and `ypos`. These rates depend on the joystick position. The variable `done` is set to `TRUE` when the user wishes to exit from the program.

The program now enters an `UNTIL` loop that repeatedly reads and processes events from the keyboard, mouse and joystick. These events may change the colour and position of the coloured circle, so the window is redrawn by the call `displayall()` each time round the loop. The call `slddelay(20)` causes a real time delay of 20 milli-seconds so that the screen is updated about 50 times per second independent of the CPU speed of the computer. The program thus has a similar timing behaviour even when run on computers of different processing power.

Finally the definition of `step` is as follows.

```

AND step() BE
{ WHILE getevent() SWITCHON eventtype INTO
  { DEFAULT: LOOP

  CASE sdle_keydown:
    SWITCHON capitalch(eventa2) INTO

```



```

    { DEFAULT:                                LOOP

      CASE sdle_arrowup:    ypos := ypos+8_000; LOOP
      CASE sdle_arrowdown:  ypos := ypos-8_000; LOOP
      CASE sdle_arrowright: xpos := xpos+8_000; LOOP
      CASE sdle_arrowleft:  xpos := xpos-8_000; LOOP

      CASE 'R': setcolour(col_red);           LOOP
      CASE 'G': setcolour(col_green);         LOOP
      CASE 'B': setcolour(col_blue);          LOOP
      CASE 'Q': done := TRUE;                 LOOP
    }

CASE sdle_keyup:                LOOP

CASE sdle_mousemotion:
  UNLESS eventa1 LOOP

CASE sdle_mousebuttonup:
CASE sdle_mousebuttondown:
  xpos, ypos := 1000*eventa2, 1000*(screenysize-eventa3)
  LOOP

CASE sdle_joyaxismotion:
  SWITCHON eventa2 INTO // Which axis
  { DEFAULT:                LOOP
    CASE 0: xdot := +eventa3/2; LOOP // Aileron
    CASE 1: ydot := -eventa3/2; LOOP // Elevator
  }

CASE sdle_joybuttonup:                LOOP
CASE sdle_joybuttondown:
  SWITCHON eventa2 INTO
  { DEFAULT:
    CASE 0: setcolour(col_red); LOOP
    CASE 1: setcolour(col_blue); LOOP
    CASE 2: setcolour(col_green); LOOP
  }

CASE sdle_quit:    done := TRUE; LOOP
}
xpos, ypos := xpos+xdot, ypos+ydot
}

```

When the user presses a key on the keyboard, moves the mouse or joystick, or

presses a mouse or joystick button, the system creates an event held in an event queue. These events can be inspected, one at a time, by calling `getevent()`. If there are no outstanding events `getevent` returns `FALSE`, otherwise it updates the global variable `eventtype` and possibly some event arguments `eventa1`, `eventa2`, `eventa3`, etc. As we will see later, which event arguments are set depends on the event type. The possible event types are declared in `SDL.h` and have names starting with `SDL_`, such as `SDL_KEYDOWN` or `SDL_JOYAXISMOTION`.

If the type was `SDL_KEYDOWN`, the argument `eventa2` will identify which key pressed. As can be seen, the program is only interested in the arrow keys and the letters R, G, B and Q. The arrow keys cause the coordinates `xpos` and `ypos` to change, R, G, B cause the colour of the circle to change and Q sets `done` to `TRUE` causing execution of the program to terminate.

If the type was `SDL_MOUSEBUTTONDOWN`, the arguments `eventa2` and `eventa3` give the coordinates of the mouse. These are used to set the coordinates of the centre of the coloured circle.

If the type was `SDL_MOUSEMOTION`, the arguments `eventa2` and `eventa3` give the coordinates of the mouse. `eventa1` is a bit pattern identifying which of the mouse buttons are currently pressed, and if any are, the coloured circle is moved to the cursor position.

If the type was `SDL_JOYAXISMOTION`, the arguments `eventa2` and `eventa3` identify which axis has moved and what its new value is. With the Logitech Attack 3 joystick there are three axes, elevator, aileron and throttle and their values range from -32768 to +32767. The elevator and aileron values are used to control how fast our coloured circle moves across the screen.

The event type `SDL_QUIT` occurs when the user clicks on the little cross at the top right hand corner of the window indicating that the program should terminate. All that `step` does in this case is to set `done` to `TRUE` causing execution to leave the event loop.

The final function, `displayall`, just fills the screen with gray, draws the coloured circle in its new position, ensuring that it is still within the window, and finally `displayall` calls `updatescreen` to update the video hardware. Its definition is as follows.

```

AND displayall() BE
{ LET x, y = xpos/1000, ypos/1000
  LET minx, miny = 20, 20
  LET maxx, maxy = screenxsize-20, screensize-20
  fillscreen(col_gray)

  IF x<minx DO x, xpos := minx, minx*1000
  IF y<miny DO y, ypos := miny, miny*1000
  IF x>maxx DO x, xpos := maxx, maxx*1000
  IF y>maxy DO y, ypos := maxy, maxy*1000
}

```

```

drawfillcircle(x, y, 20)
updatescreen()
}

```

5.9 e^{ix} and rotation

We all know that when we square a number the result is positive. For example, $2^2 = 4$ and $(-3)^2 = 9$. But mathematicians are not satisfied with this since they sometimes find it useful to take the square root of negative numbers. You might think they are mad but let us see what they do and why it is useful. The trick is to postulate a new number i having the property that $i^2 = -1$. Such a number, of course, cannot exist so they call it an *imaginary* number. They let it obey all the normal algebraic rules that ordinary (*real*) numbers have. Using i we can make complex numbers such as $2 + 3i$, and these also obey the normal rules of algebra. For instance, we can multiply them as in

$$(a + ib) \times (c + id) = ac + i^2bd + aid + ibc = (ac - bd) + i(ad + bc)$$

We have seen the series for e^x in Section 4.31 which was as follows

$$e^x = 1 + x + \frac{x^2}{2!} + \frac{x^3}{3!} + \dots$$

If we substitute ix for x in this equation we get an equation with some very interesting properties.

$$\begin{aligned} e^{ix} &= 1 + ix + \frac{i^2x^2}{2!} + \frac{i^3x^3}{3!} + \frac{i^4x^4}{4!} + \frac{i^5x^5}{5!} + \dots \\ &= 1 + ix - \frac{x^2}{2!} - \frac{ix^3}{3!} + \frac{x^4}{4!} + \frac{ix^5}{5!} + \dots \\ &= \left(1 - \frac{x^2}{2!} + \frac{x^4}{4!} + \dots\right) + i\left(x - \frac{x^3}{3!} + \frac{x^5}{5!} + \dots\right) \end{aligned}$$

The real and imaginary parts of e^{ix} are so important they are given the names cosine and sine, normally written as $\cos x$ and $\sin x$.

$$\begin{aligned} \cos x &= 1 - \frac{x^2}{2!} + \frac{x^4}{4!} + \dots \\ \sin x &= x - \frac{x^3}{3!} + \frac{x^5}{5!} + \dots \end{aligned}$$

Notice that if we change the sign of x , all the terms in the cos series remain unchanged, but those in the sin series are all negated, so

$$\cos(-x) = \cos x$$

$$\sin(-x) = -\sin x$$

Notice, also, that

$$e^{ix} \times e^{-ix} = e^{ix-ix} = e^0 = 1$$

But

$$\begin{aligned} e^{ix} \times e^{-ix} &= (\cos x + i \sin x) \times (\cos(-x) + i \sin(-x)) \\ &= (\cos x \times \cos(-x) - \sin x \times \sin(-x)) + i(\cos x \times \sin(-x) - \sin x \times \cos(-x)) \\ &= (\cos^2 x + \sin^2 x) + i(-\cos x \times \sin x + \sin x \times \cos x) \\ &= \cos^2 x + \sin^2 x \end{aligned}$$

So

$$\cos^2 x + \sin^2 x = 1$$

Using the formula

$$\frac{d}{dx} \left(\frac{x^n}{n!} \right) = \frac{x^{n-1}}{(n-1)!}$$

that we derived earlier, we can easily obtain the following two results.

$$\begin{aligned} \frac{d}{dx} \sin x &= \frac{d}{dx} \left(x - \frac{x^3}{3!} + \frac{x^5}{5!} + \dots \right) \\ &= 1 - \frac{x^2}{2!} + \frac{x^4}{4!} + \dots \\ &= \cos x \end{aligned}$$

and

$$\begin{aligned} \frac{d}{dx} \cos x &= \frac{d}{dx} \left(1 - \frac{x^2}{2!} + \frac{x^4}{4!} - \frac{x^6}{6!} + \dots \right) \\ &= -x + \frac{x^3}{3!} - \frac{x^5}{5!} + \dots \\ &= -\sin x \end{aligned}$$

It turns out that the arguments of \cos and \sin are best thought of as angles and, since mathematicians like to use greek letters for angles, we will use letters such as θ and ϕ in place of x and y , saving x and y for horizontal and vertical coordinates on graph paper.

It is instructive to see how $\cos \theta$ and $\sin \theta$ change as θ varies from 0 to 2π . The following program plots them with the curve for $\cos \theta$ in red and the curve for $\sin \theta$ in green. It also plots the points with coordinate $(\cos \theta, \sin \theta)$ in blue centred on the graph. The program uses variants of several of the functions used in the evaluation of $e^{\pi\sqrt{163}}$ given in Section 4.32, and as with the previous program we use multi digit numbers of radix 10000 held in vectors, but this time the upper bound is 4 which is sufficient for a precision of nearly 16 decimal digits after the decimal point. If v is such a number, then $10000*v!0+v!1$ is the equivalent scaled fixed point number with 4 decimal digits after the decimal point. The digit in $v!0$ is signed, but all the other digits are positive in the range 0 to 9999. This convention is somewhat analagous to the interpretation of the bits in a 2s complement signed binary numbers.

The program (which is in `bcplprogs/raspi/cossin.b`) starts as follows.

```
// Insert the SDL library source code as a separate section

GET "libhdr"
GET "sdl.h"
GET "sdl.b"
.
GET "libhdr"
GET "sdl.h"

GLOBAL {
  x0:ug // The scaling parameters
  y0
  scale
  col_white; col_blue; col_green; col_red; col_gray; col_black
}

MANIFEST { upb = 4 }

LET start() = VALOF
{ initsdl()
  mkscreen("Cosine and sine curves", 800, 400)

  // Declare a few colours in the pixel format of the screen
  col_white := maprgb(255, 255, 255)
  col_black := maprgb( 0, 0, 0)
  col_blue := maprgb( 0, 0, 225)
```

```

col_green := maprgb( 0, 185,  0)
col_red   := maprgb(195,  0,  0)
col_gray  := maprgb(228, 228, 228)

fillscreen(col_gray)
updatescreen() //Update the screen hardware

setscaling() // Set the scaling parameters for smoveto etc.

setcolour(col_black); plotgraphpaper()
setcolour(col_red);   plot_fn(cosine)
setcolour(col_green); plot_fn(sine)
setcolour(col_blue);  plotcircle()

updatescreen() //Update the screen hardware
sdlldelay(20_000) //Pause for 20 secs

closesdl()
RESULTIS 0
}

```

All that remains is to define the plotting functions and the one that sets the scaling parameters so that the graph will appear appropriately sized and centred in the window.

The graph paper ranges from 0.0000 to 2×3.1415 in the x (horizontal) direction and from -1.0000 to +1.0000 in the y (vertical) direction with (0, -1) being the bottom left corner of the graph. Lines will be drawn using the functions `smoveto` and `sdrawto` which both take scaled fixed point numbers with 4 digits after the decimal point to specify the coordinates on the graph paper. They are defined as follows.

```

AND smoveto(x, y) BE
{ LET screenx = x0 + muldiv(x, scale, 1_000_000)
  AND screeny = y0 + muldiv(y, scale, 1_000_000)
  moveto(screenx, screeny)
}

AND sdrawto(x, y) BE
{ LET screenx = x0 + muldiv(x, scale, 1_000_000)
  AND screeny = y0 + muldiv(y, scale, 1_000_000)
  drawto(screenx, screeny)
  updatescreen() //Update the screen
  sdlldelay(20) // So we can see the curves being drawn
}

```

Both these functions use the scaling parameters `x0`, `y0` and `scale` to transform the graph paper coordinates to coordinates on the window. Notice also that `sdrawto` updates the screen and has a slight real time delay so that we can watch the graphs being drawn. The scaling parameters are set by the next function

```
AND setscaling() BE
{ // Set the scaling parameters x0, y0 and scale used by smoveto
  // and sdrawto so that the drawing area from x = 0 to 2 pi and
  // y = -1.0 to +1.0 appears centered in the window.
  // The conversion from graph coordinates (x, y) to
  // screen coordinates will be as follows

  // screenx = x0 + muldiv(x, scale, 1_000_000)
  // screeny = y0 + muldiv(y, scale, 1_000_000)

  x0    := screenxsize / 20
  y0    := screenysize / 2
  scale := muldiv(screenxsize*9/10, 1_000_000, 2 * 3_1415)
}
```

Next comes the plotting functions. The first draws the graph paper consisting of lines for the edges, the x axis and vertical lines at $\pi/2$, π and $3\pi/2$.

```
AND plotgraphpaper() BE
{ FOR i = -1 TO +1 DO
  { // Draw horizontal lines at -1.0000, 0 and 1.0000
    smoveto(      0, i * 1_0000)
    sdrawto( 2*3_1415, i * 1_0000)
  }
  FOR i = 0 TO 4 DO
    { // Draw vertical lines at 0, pi/2, pi 3pi/2 and 2pi
      smoveto( i*3_1415/2, -1_0000)
      sdrawto( i*3_1415/2, +1_0000)
    }
  }
}
```

The next function `plot_fn` is used to plot the cosine and sine curves. It takes an argument `f` which is either `cosine` or `sine` and draws the curve as a sequence of 100 short line segments. It uses a multi digit representation of the angle `theta` which it passes to `f` each time a new value is to be computed. The values of θ are of the form $2n\pi/100$ for n in the range 0 to 100. It uses `mulbyk` and `divbyk` defined later.

```

AND plot_fn(f) BE FOR n = 0 TO 100 DO
{ // Plot f(theta) from theta = 0 to 2 pi
  LET theta = VEC upb
  LET pi = TABLE 3,1415,9265,3589,7932
  FOR j = 0 TO upb DO theta!j := pi!j // Set theta = pi
  mulbyk(theta, 2*n)
  divbyk(theta, 100)
  TEST n=0
  THEN smoveto(10000*theta!0+theta!1, f(theta))
  ELSE sdrawto(10000*theta!0+theta!1, f(theta))
}

```

The function `plotcircle` has much in common with `plot_fn` but draws short line segments between points with coordinates $(\cos \theta, \sin \theta)$. A scaled number representing 3.1415 is added to the x coordinate to place the circle at the center of the graph.

```

AND plotcircle() BE FOR n = 0 TO 100 DO
{ LET theta = VEC upb
  LET pi = TABLE 3,1415,9265,3589,7932
  FOR i = 0 TO upb DO theta!i := pi!i // Set theta = pi
  mulbyk(theta, 2*n)
  divbyk(theta, 100)
  TEST n=0
  THEN smoveto(cosine(theta)+3_1415, sine(theta))
  ELSE sdrawto(cosine(theta)+3_1415, sine(theta))
}

```

The functions `cosine` and `sine` compute multi digit representations of $\cos \theta$ and $\sin \theta$ using the two series we have already seen, namely.

$$\cos x = 1 - \frac{x^2}{2!} + \frac{x^4}{4!} - \dots$$

$$\sin x = x - \frac{x^3}{3!} + \frac{x^5}{5!} - \dots$$

Since these series have much in common, `cosine` and `sine` both use an auxiliary function `sumseries(theta, n)` to perform the summation. `theta` is a multi digit representation of θ and `n=0` for `cosine` and `n=1` for `sine`. The function is defined as follows.

```

AND sumseries(theta, n) = VALOF
{ // n=0 return cosine theta as a scaled number with 4 decimal
  // digits after the decimal point

```



```

// n=1 return sine theta as a scaled number with 4 decimal
//      digits after the decimal point
LET sum  = VEC upb
LET term = VEC upb // Next term to add, x^n/n!
LET negt2 = VEC upb // To hold -theta^2

FOR i = 0 TO upb DO sum!i, term!i := 0, 0 // Set sum and term to zero
term!0 := 1 // Set sum to 1.0000

IF n DO mult(term, term, theta) // Set term for sine

FOR i = 0 TO upb DO negt2!i := theta!i // Set negt2 = theta
mult(negt2, negt2, negt2) // negt2 now holds theta^2
neg(negt2, negt2) // negt2 now hold -theta^2

UNTIL iszero(term) DO
{ add(sum, sum, term) // Accumulate the current term
  mult(term, term, negt2) // Calculate the next term in the series
  divbyk(term, n+1)
  divbyk(term, n+2)
  n := n+2
}

RESULTIS 1_0000*sum!0 + sum!1 // Return a fix point scaled number
}

AND iszero(v) = VALOF
{ FOR i = 0 TO upb IF v!i RESULTIS FALSE
  RESULTIS TRUE
}

```

The definition of `sumseries` should be reasonably understandable. It accumulates the result in `sum` by adding the next term (held in `term`) until `term` represents zero. The next term is computed from the previous one by multiplying by $-\frac{\theta^2}{(n+1)(n+2)}$ incrementing n by 2 each time. The initial value of `term` represents either 1 for cosine or θ for sine. Once the series has been summed, it is converted to a scaled fixed point number with 4 decimal digits after the decimal point by the expression `1_0000*sum!0 + sum!1`. Finally `cosine` as `sine` are defined by suitable calls of `sumseries`.

```
AND cosine(theta) = sumseries(theta, 0)
```

```
AND sine(theta) = sumseries(theta, 1)
```

All that remains is to define the low level functions to perform arithmetic on our multi digit representation of signed numbers. The first of these is `mult` which computes the product of the numbers in `y` and `z` storing the result in `x`. The comments explain how it works.

```

AND mult(x, y, z) BE
{ // Set x to the product of y and z
  // x, y and z need not be distinct, so copies are made.
  LET res    = VEC upb+3 // res includes some guard digits
  LET cy     = VEC upb   // cy and cz will hold copies of y and z
  LET cz     = VEC upb
  LET resneg = FALSE

  // Make copies of y and z
  FOR i = 0 TO upb DO cy!i, cz!i := y!i, z!i
  // Set res to zero

  FOR i = 0 TO upb+3 DO res!i := 0
  // Rounding of the result is done by adding 1/2 to the last digit
  res!(upb+1) := 5000

  IF cy!0<0 DO { neg(cy, cy); resneg := ~resneg }
  IF cz!0<0 DO { neg(cz, cz); resneg := ~resneg }

  // cy and cz now both represent positive numbers
  FOR i = 0 TO upb IF cy!i FOR j = 0 TO upb+3-i DO
  { LET p = i + j // Destination in range 0 to upb+3
    LET d = res!p + cy!i * cz!j
    LET carry = d / 10000
    IF p=0 DO { res!0 := d; LOOP } // res!0 is allowed to be >= 10000
    res!p := d MOD 10000

    // Deal with the carry, if any
    WHILE carry DO
    { p := p-1 // Position of next digit to the left
      d := res!p + carry
      IF p=0 DO { res!0 := d; BREAK }
      carry := d / 10000
      res!p := d MOD 10000
    }
  }
  TEST resneg
  THEN neg(x, res) // Set x = -res
  ELSE FOR i = 0 TO upb DO x!i := res!i // Set x = res
}

```

The next function copies the negated value of y into x . It is perhaps best understood by considering the operation on a number with only one digit (of radix 10000) after the decimal point. Suppose num represents 1.2345, then $\text{num!0}=1$ and $\text{num!1}=2345$. Our representation -1.2345 has $\text{num!0}=-2$ and $\text{num!1}=7655$ since the fractional part is positive. This result can be computed as follows. First negate both the integer and fractional parts giving $\text{num!0}=-1$ and $\text{num!1}=-2345$, then correct the fractional part by adding 10000 to it and subtracting 1 from the integer part in compensation. The addition 10000 can be done by adding 9999 and then incrementing the result. The fractional part thus becomes $9999-2345+1 = 7654+1 = 7655$. Note that the addition of 1 causes a carry of 1 into the integer part, if the original fractional part was zero.

```

AND neg(x, y) BE
{ // Set x to -y
  LET carry = 1
  FOR i = upb TO 1 BY -1 DO
  { LET d = 9999 - y!i + carry
    x!i := d MOD 10000
    carry := d / 10000
  }
  x!0 := carry - y!0 - 1
}

```

The `add` function adds corresponding digits of y and z starting from the least significant end, dealing with carries as it goes. The result is placed in x . Note that the fraction digits are all positive but the integer part (in element zero) is signed and need not be in the range -9999 to +9999.

```

AND add(x, y, z) BE
{ LET carry = 0
  FOR i = upb TO 1 BY -1 DO
  { LET d = y!i + z!i + carry
    x!i := d MOD 10000
    carry := d / 10000
  }
  x!0 := y!0 + z!0 + carry
}

```

Subtraction is performed by negating z then calling `add`.

```

AND sub(x, y, z) BE
{ // Set x = y - z
  // Copy z because it might be the same as y

```

```

    LET cz = VEC upb
    neg(cz, z)
    add(x, y, cz)
}

```

The function `mulbyk` multiplies the multi digit signed number in `v` by the integer `k` placing the result back in `v`. It conditionally changes the signs of `v` and `k` so the multiplication is performed on positive values. It then changes the sign of `v` again at the end, if needed.

```

AND mulbyk(v, k) BE
{ LET carry = 0
  LET resneg = FALSE
  IF v!0<0 DO { neg(v, v); resneg := ~resneg }
  IF k<0 DO { k := -k; resneg := ~resneg }

  FOR i = upb TO 1 BY -1 DO
  { LET d = v!i * k + carry
    v!i := d MOD 10000
    carry := d / 10000
  }
  v!0 := v!0 * k + carry

  IF resneg DO neg(v, v)
}

```

The function `divbyk` divides the multi digit signed number in `v` by the integer `k` placing the result back in `v`.

```

AND divbyk(v, k) BE
{ LET carry = 0
  LET resneg = FALSE
  IF v!0<0 DO { neg(v, v); resneg := ~resneg }
  IF k<0 DO { k := -k; resneg := ~resneg }

  FOR i = 0 TO upb DO
  { LET d = carry*10000 + v!i
    v!i := d / k
    carry := d MOD k
  }
  IF resneg DO neg(v, v)
}

```

When the above program runs, it creates the window shown below containing the curves for $\cos \theta$ in red, $\sin \theta$ in green and a circle in blue. The short delay in `sdrawto` allows you to see these curves being drawn.

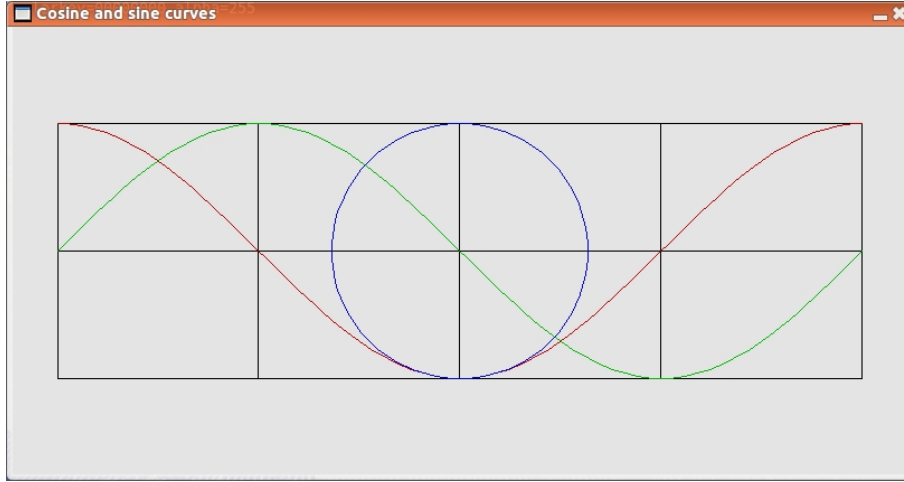

Before leaving this section, there is one last formula we need to derive. Looking at the blue circle drawn by the previous program, it is clear the coordinates $(\cos \theta, \sin \theta)$ lie on a circle of radius one. θ is not measured in degrees but in *radians* which is the distance around the circumference of the unit circle from the point $(1, 0)$. Thus $\theta = 2\pi$ corresponds to an angle of 360° .

Let us assume a point P on the unit circle is at an angle ϕ from the x axis and that its coordinates are $(x, y) = (\cos \phi, \sin \phi)$. If we wanted to rotate P anti-clockwise by an angle θ to point Q , it would move to $(X, Y) = (\cos(\theta + \phi), \sin(\theta + \phi))$. It would be really useful to have formulae that compute these coordinates in terms of the old ones and θ , and this can easily be done by considering $e^{i(\theta + \phi)}$ as follows

$$e^{i(\theta + \phi)} = \cos(\theta + \phi) + i \sin(\theta + \phi)$$

But also

$$\begin{aligned} e^{i(\theta + \phi)} &= e^{i\theta} \times e^{i\phi} \\ &= (\cos \theta + i \sin \theta) \times (\cos \phi + i \sin \phi) \\ &= (\cos \theta \cos \phi - \sin \theta \sin \phi) + i(\sin \theta \cos \phi + \cos \theta \sin \phi) \end{aligned}$$

So

$$\begin{aligned} \cos(\theta + \phi) &= \cos \theta \cos \phi - \sin \theta \sin \phi \\ \sin(\theta + \phi) &= \sin \theta \cos \phi + \cos \theta \sin \phi \end{aligned}$$

Remembering the old coordinates were $(x, y) = (\cos \phi, \sin \phi)$, we can calculate the new coordinates $(X, Y) = (\cos(\theta + \phi), \sin(\theta + \phi))$ as follows

$$\begin{aligned} X &= \cos \theta \times x - \sin \theta \times y \\ Y &= \sin \theta \times x + \cos \theta \times y \end{aligned}$$

Mathematicians usually prefer to write these two equations as a single equation having exactly the same meaning using what is called matrix notation.

$$\begin{pmatrix} X \\ Y \end{pmatrix} = \begin{pmatrix} \cos \theta & -\sin \theta \\ \sin \theta & \cos \theta \end{pmatrix} \begin{pmatrix} x \\ y \end{pmatrix}$$

It is easy to see that these formulae work just as well when (x, y) is not on the unit circle but on a circle of radius r , say. These formulae will be used later when we wish to rotate, for example, the moon lander space craft. To see a geometric proof of the $\cos(\theta + \phi)$ equation do a web search on: **cos a plus b geometric proof**.

Note that when θ is small enough to allow us to ignore terms such as $\frac{\theta^2}{2!}$ and $\frac{\theta^3}{3!}$ then from the series we can deduce that $\cos \theta$ is approximately 1 and $\sin \theta$ is approximately θ . We take advantage of these approximations when dealing with small rotations in implementation of the flight simulator given later.

To summarise this section, we started by considering the impossible number i whose square is -1 and then thought of the equally mind boggling idea of computing e^{ix} , that is multiplying 1 by e , ix times. This resulted in two functions, \cos and \sin , which, when plotted, looked beautiful and rather similar. We even showed that $\cos^2 \theta + \sin^2 \theta = 1$ which was confirmed by plotting points of the form $(\cos \theta, \sin \theta)$ showing they all lay on the unit circle. We went on to deduce formulae for $\cos(\theta + \phi)$ and $\sin(\theta + \phi)$ which we will be used later in this chapter. What this tells us is that mathematics is not just about learning multiplication tables and doing tedious numerical sums, but is more to do with extraordinary ideas and beautiful results obtained with the aid of a little simple algebra. Some of the results turn out to be very useful, while others, like Euler's identity $e^{i\pi} + 1 = 0$, are just wondrous to observe. (Try a web search on: **e to the i pi plus one equals zero**.)

If you have reached this far in this section you are either already a mathematician or well on the way to becoming one. Well done!

5.10 The Riemann ζ -function

If you survived the previous section you may well find this one interesting. It contains no programming and the mathematics is probably the most advanced of any appearing in the document. However the algebra is simple and easy to understand and the resulting equation is truly amazing. We saw on page 242 that

$$\frac{1}{1-x} = 1 + x + x^2 + x^3 + \dots$$

This equation is valid if $|x| < 1$ where $|x|$ denotes the absolute value of x . A possible value for x is $\frac{1}{p}$ where p is a prime number, giving

$$\frac{1}{1-\frac{1}{p}} = 1 + \frac{1}{p} + \frac{1}{p^2} + \frac{1}{p^3} + \dots$$

If we multiply all the terms of the form $\frac{1}{1-\frac{1}{p}}$ together for each prime p , we obtain an interesting result consisting of the sum of terms such as $\frac{1}{2^s 3^{2s} 7^s}$, but since each number n can only be factorised into primes in one way, the sum will only contain each $\frac{1}{n}$ once. This tells us that

$$\prod_{p=\text{prime}} \frac{1}{1-\frac{1}{p}} = 1 + \frac{1}{2} + \frac{1}{3} + \frac{1}{4} + \dots$$

Unfortunately the sum on the right hand side diverges to infinity, but if we raise each prime to the power s both sides can be made to converge to finite values. The equation then becomes

$$\prod_{p=\text{prime}} \frac{1}{1-\frac{1}{p^s}} = 1 + \frac{1}{2^s} + \frac{1}{3^s} + \frac{1}{4^s} + \dots$$

The right hand side is Riemann's zeta function $\zeta(s)$, normally defined as follows

$$\zeta(s) = \sum_{i \geq 1} \left(\frac{1}{i^s}\right)$$

This function is totally extraordinary and possibly the most significant function in all of mathematics since it relates the set of all prime numbers to all the natural numbers and is valid for most values of s even when s is complex. As stated in the Wikipedia web page, it plays a pivotal role in analytic number theory and has applications in physics, probability theory, and applied statistics. It has an infinite number of zeroes when s is a real number, but surprisingly, when s is allowed to be complex, all the other zeroes seem to be on the line $s = \frac{1}{2} + it$, but this has not yet been proved to be true.

5.11 Polar Coordinates

We saw in the previous sections that complex numbers can be thought of as points on a two dimensional graph, with the horizontal and vertical axes representing the real and imaginary components, respectively. Such a graph is often called an *Argand diagram* and is useful in helping to understand how complex numbers behave. A complex number $z = x + iy$ can be represented by the point in the Argand diagram with cartesian coordinates (x, y) . However, we can also describe it is by the pair (r, θ) where r is the distance between z and the origin, and θ is the angle between the line from the origin to z and the real axis. The quantities r and θ are called *polar coordinates*, and this representation turns out to be very useful. The conversion from polar coordinate (r, θ) to cartesian coordinates (x, y) is easy, since $x = r \cos \theta$ and $y = r \sin \theta$. So, $z = r \cos \theta + ir \sin \theta$ which, as we saw in the previous section, can also be written as $re^{i\theta}$.

The product of two complex numbers $re^{i\theta}$ and $se^{i\phi}$ is $rse^{i(\theta+\phi)}$. So, using polar coordinates, the product of (r, θ) and (s, ϕ) is $(rs, \theta + \phi)$. It is thus clear that when we multiply two complex numbers together, the polar distance of the result is the product of the polar distances of the two operands, and the polar angle is the sum of the angles of the two operands.

If we consider a number (r, θ) on or inside the unit circle in the Argand diagram then r will be less than or equal to one and the square of (r, θ) will still be within the unit circle. If, on the other hand, $r > 1$ the square will be further away from the origin and repeatedly squaring the result will cause it to diverge to infinity. Thus if we apply this repeated squaring process to arbitrary initial values, we only avoid divergence for all initial values on or inside the unit circle. This mechanism defines the set of points inside or on the unit circle and the boundary of this set is the unit circle itself.

5.12 The Mandelbrot Set

Benoit Mandelbrot considered a slight variation of the repeated squaring process. Every time z is squared a small complex constant c is added to the result. So the process involves repeated performing $z := z^2 + c$. He chose to start with $z = 0$. For some values of c , such as $c = 3$, the process diverges, and for other settings, such as $c = 0$ or $c = -1$, the values of z remain bounded. The possible values of c that cause the process to remain bounded is called the Mandelbrot set, and it turns out to have some extraordinarily unexpected properties. The program presented here displays a specified square region of the Mandelbrot set by performing the iteration a limited number of times for all possible values of c in the square. If z remains within three units of the origin throughout all the iterations, c is in or close to the Mandelbrot set and is plotted as a black pixel. If, on the other hand, z moves further than three units from the origin, the process

is clearly going to diverge and the corresponding pixel is given a colour depending on how many iterations were required for z to escape. The resulting picture is sometimes rather surprising.

The program is called `bcplprogs/raspi/mandset.b` and starts as follows.

```
// Insert the SDL library source code as a separate section

GET "libhdr"
GET "sdl.h"
GET "sdl.b"
.
GET "libhdr"
GET "sdl.h"

GLOBAL {
  a:ug
  b
  size
  limit    // The iteration limit
  v
  col_white; col_gray; col_black
}

MANIFEST {
  One = 100_000_000 // The number representing 1.00000000
  width=512
  height=width      // Ensure the window is square
}
```

The global variables `a`, `b` and `size` will hold the details of a square region to display with sides of length $2*\text{size}$ centred at position (a,b) , and `limit` is the upper limit of the number of iterations to use.

The manifest constant `One` gives the integer value of the scaled numbers used in the calculation. This allow for number in about the range -20.0 to $+20.0$ to be represented with 8 decimal digits after the decimal point. The main program is as follows.

```
LET start() = VALOF
{ LET s = 0           // Region selector
  LET argv = VEC 50

  UNLESS rdargs("s/n,a/n,b/n,size/n,limit/n", argv, 50) DO
  { writes("Bad arguments for mandset*n")
    RESULTIS 0
```

```

}

v := 0

// Default settings
a, b, size := -50_000_000, 0, 180_000_000
limit := 38

IF argv!0 DO s      := !argv!0      // s/n
IF argv!1 DO a      := !argv!1      // a/n
IF argv!2 DO b      := !argv!2      // b/n
IF argv!3 DO size   := !argv!3      // size/n
IF argv!4 DO limit  := !argv!4      // limit/n

IF 1<=s<=7 DO
{ LET limtab = TABLE 38, 38, 38, 54, 70, // 0
                        80, 90, 100, 100, 110, // 5
                        120, 130, 140, 150, 160, // 10
                        170, 180, 190, 200, 210, // 15
                        220                          // 20

  limit := limtab!s
  a, b, size := -52_990_000, 66_501_089, 50_000_000
  FOR i = 1 TO s DO size := size / 10
}

initsdl()
mkscreen("Mandelbrot Set", width, height)

// Declare a few colours in the pixel format of the screen
col_white := maprgb(255, 255, 255)
col_gray  := maprgb(128, 128, 128)
col_black := maprgb( 0,  0,  0)

v := getvec(width*height-1)
// Initialise v the vector of random pixel addresses.
FOR i = 0 TO width*height - 1 DO v!i := i
// Random shuffle v so that the screen pixels are filled in
// in random order.
FOR i = width*height - 1 TO 1 BY -1 DO
{ LET j = randno(i+1) - 1 // Random number in range 0 .. i
  LET t = v!j
  v!j := v!i
  v!i := t
}

```

```

plotset()

setcolour(col_white)
plotf(5, 50, "s      = "); plotf(50, 50, " %i4*n", s)
plotf(5, 35, "a      = %11.8d b = %11.8d size = %11.8d", a, b, size)
plotf(5, 20, "limit = "); plotf(50, 20, " %i4*n", limit)
updatescreen()

sdldelay(60_000) //Pause for 60 secs
closesdl()
IF v D0 freevec(v)
RESULTIS 0
}

```

The program takes five possible arguments `s`, `a`, `b`, `size` and `limit` all of which are numeric. The first argument can be used to select one of 7 interesting regions to display, the next three can specify other regions, and `limit` can be used to set the iteration limit.

The vector `v` is initialised to the integers 0 to `width*height-1` stored in random order. Each element holds the x, y coordinates of a pixel position packed as two adjacent 9-bit values. The i^{th} pixel to be drawn will be at (x, y) position $(v!i\&\#x1FF, (v!i>>9)\&\#x1FF)$. This vector holds the random order in which the pixels are drawn.

The mandelbrot set is then plotted by the call `plotset()`. Some text is then written to the screen specifying the position and size of the region displayed. A colour bar is then drawn near the bottom of the screen to show the mapping between iteration count and the corresponding colour. Finally the screen is updated and displayed for 60 seconds.

```

AND colfill(p, m, col1, col2) BE
{ //writef("colfill: p=%i5 m=%i3 col1=%o9 col2=%o9*n", p, m, col1, col2)
  //abort(1000)
  TEST m<=1
  THEN { putcolour(p, 0, col1)
        }
  ELSE { // Fill p!0 to p!(m-1) with colours using linear
        // interpolation.
        LET m2 = m/2 // Midpoint
        LET midcol = (col1+col2)/2 // Midpoint colour
        colfill(p, m2, col1, midcol)
        colfill(p+m2, m-m2, midcol, col2)
        }
}

AND putcolour(p, i, col) BE

```

```

{ LET r, g, b = (col>>18)&255, (col>>9)&255, col&255
// writef("putcolour: p=%i6 i=%i3 col=%o9 r=%i3 g=%i3 b=%i3*n",
//       p, i, col, r, g, b)
//abort(1000)
  p!i := maprgb(r, g, b)
}

AND setpalette(p, lim, colv, n) BE
{ // Fill in colours in p!0 to p!lim based on
  // the colours in colv!0 to colv!n
//writef("setpalette: p=%i5 lim=%i3 colv=%i5 n=%i3*n", p, lim, colv, n)
//abort(1000)
  IF lim<=n DO
  { FOR i = lim TO 0 BY -1 DO { putcolour(p, i, colv!n); n := n-1 }
    RETURN
  }
  IF lim - lim/4 >= n DO
  { LET m = lim/4
    colfill(p, m, colv!0, colv!1)
    setpalette(p+m, lim-m, colv+1, n-1)
    RETURN
  }
  // Copy colours from colv! to colv!n to p!(lime-n+1) to p!lim
  WHILE n>0 DO
  { putcolour(p, lim, colv!n)
    lim, n := lim-1, n-1
  }
  colfill(p, lim+1, colv!0, colv!1)
}

```

These few functions construct a colour palette in `colourv` that depends on the selected iteration limit. The colours are chosen so that they move from yellow through white to various shaded of green, and for points most distant from the Mandelbrot the various shades of blue are chosen.

```

AND plotset() BE
{ // The following table hold 8-bit rgb colours packed
  // in three 9-bit fields. It is used to construct a palette
  // of colours depending on the current limit setting.
  LET coltab = TABLE
    #300_300_377, #200_200_377, #100_100_377, #000_000_377, // 0
    #040_040_300, #070_140_300, #070_110_260, #100_170_260, // 4
    #120_260_260, #150_277_240, #120_310_200, #120_340_200, // 8
    #120_377_200, #100_377_150, #177_377_050, #270_377_070, // 12
    #350_377_200, #350_300_200, #340_260_200, #377_260_140, // 16

```

```

#377_220_100, #377_170_100, #347_200_100, #360_100_000, // 20
#240_300_000, #100_277_000, #000_377_000, #230_350_230, // 24
#340_340_377, #377_377_377, #377_377_200, #377_377_100, // 28
#377_377_000 // 32

LET mina = a - size
LET minb = b - size

LET colourv = VEC 500

setpalette(colourv, limit, coltab, 32)

fillsurf(col_gray)

// Draw a small white square at the centre
setcolour(col_white)
drawrect(width*45/100, height*45/100,
         width*55/100, height*55/100)

// Draw the colour bar
FOR x = 0 TO width-1 DO
{ LET i = ((limit+1) * x) / width
  LET p, q = x, 6
  setcolour(colourv!i)
  moveto(p, q)
  drawby(0, 6)
}
updatescreen()

FOR i = 0 TO width*height - 1 DO // Number of points to plot
{ LET vi = v!i
  LET colour = ?
  LET itercount = ?
  LET x, y, p, q = ?, ?, ?, ?

  // Periodically update the screen as the pixels are drawn
  IF i MOD 100 = 0 DO updatescreen()

  x := vi      & #x1FF      // 0 .. 511
  y := (vi>>9) & #x1FF      // 0 .. 511

  // Calculate c = p + iq corresponding to pixel (x,y)
  p := mina + muldiv(2*size, x, 511)
  q := minb + muldiv(2*size, y, 511)

```

```

    itercount := mandset(p, q, limit)
    TEST itercount < 0
    THEN colour := col_black
    ELSE colour := colourv!itercount

    setcolour(colour)
    drawpoint(x, y)
}

// Draw the palette of colours
FOR x = 0 TO width DO
{ LET i = (limit * x) / width
  LET p, q = x, 6
  setcolour(colourv!i)
  moveto(p, q)
  drawby(0, 6)
}
updatescreen()
}

```

The function `plotset` plots the requested region of the Mandelbrot set. It does this by plotting each pixel in the requested region in random order. For each point, if `mandset` returns `-1` it is in or close to the Mandelbrot set and so is coloured black, otherwise it is given a colour depending on the number of iterations needed before z is more than three units away from the origin. The palette of colours is placed in the vector `colourv`.

```

AND mandset(p, q, n) = VALOF
{ LET x, y = 0, 0 // z = x + iy is initially zero
  // c = a + ib is the point we are testing
  FOR i = 0 TO n DO
  { LET t = ?
    LET x3, y3 = x/3, y/3 // To avoid possible overflow
    LET rsq = muldiv(x3, x3, One) + muldiv(y3, y3, One)

    // Test whether z is diverging, ie is x^2+y^2 > 9
    IF rsq > One RESULTIS i

    // Square z and add c
    // Note that (x + iy)^2 = (x^2-y^2) + i(2xy)
    t := muldiv(2*x, y, One) + b
    x := muldiv(x, x, One) - muldiv(y, y, One) + a
    y := t
  }
}

```

```

// z did not diverge after n iterations
RESULTIS -1
}

```

This function initially sets $z = x + iy$ to zero and then repeatedly performs the assignment $z := z^2 + c$ up to n times. If at any stage z move further than three units from the origin, the function returns the iteration count at that moment, otherwise it returns -1 indicating that c is in or close to the Mandelbrot set.

The following three diagrams show the result of running this program with a first argument of 0, 2 and 4, respectively, using an appropriate iteration limit for each.

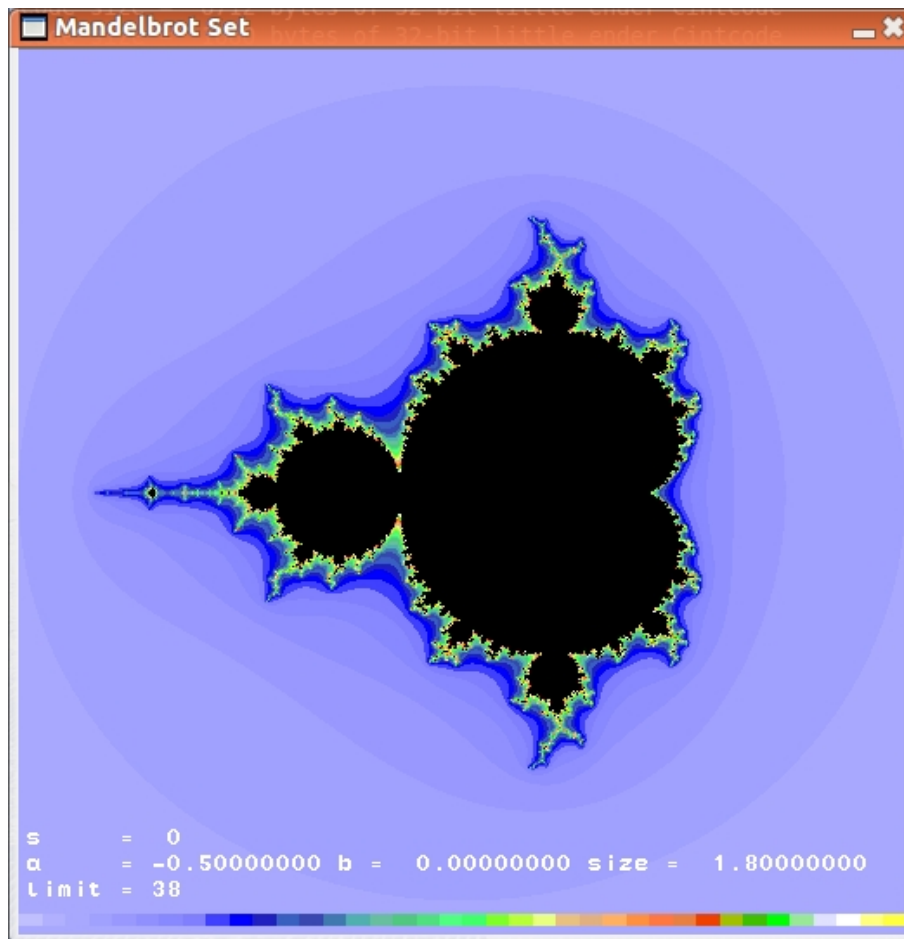

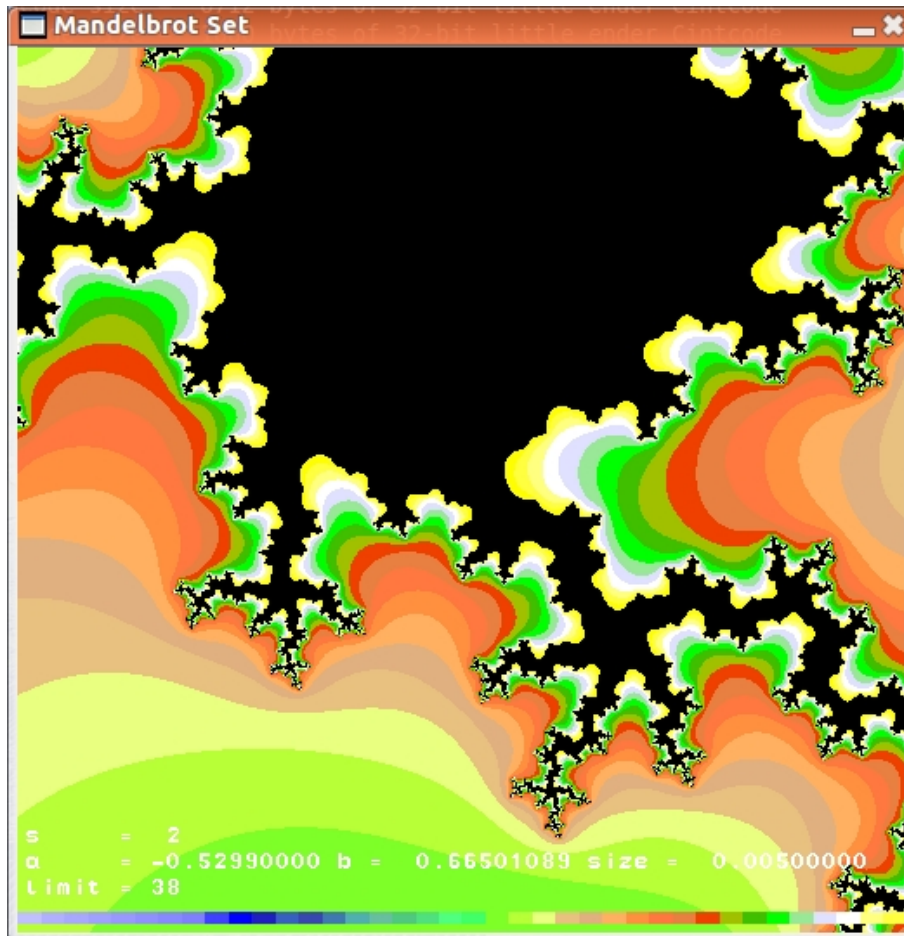

These images were saved using the shell command `gnome-screenshot -i` and converted to `.jpg` format using `gimp`. If these commands are not yet installed on your machine type the following.

```
sudo apt-get install gnome-screenshot
sudo apt-get install gimp
```

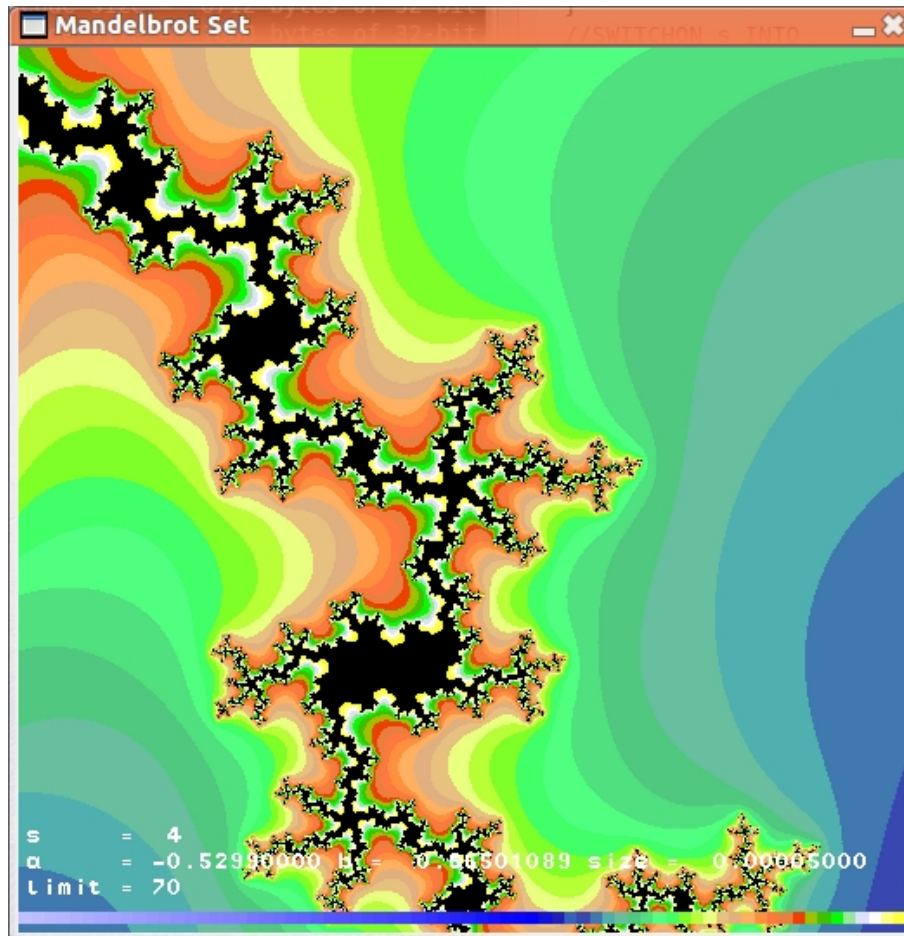



This program uses only 8 digits of precision after the decimal point and this limits the detail that can be displayed when really small regions are selected. By selecting $s=6$ or 7 you will see that 8 decimal digits of precision is insufficient for this level of detail. If the program were rewritten in C, the calculation could easily be done using double length floating point numbers giving a precision of about 15 decimal digits. If one unit corresponds to a distance of a metre, we would be able to display regions as small as, say, a hydrogen atom (which has a diameter of about 10^{-10} metres). However the iteration limit would have to be increased somewhat. We could, of course, go for much higher precision using the mechanism used in Section 4.32. By doing this, it would be possible to explore much tinier regions of the Mandelbrot set that have never been seen before by anyone. A high definition version of this program called `raspi/hdmandset.b` is available. Its first argument s selects different magnifications of an interesting point in the Mandelbrot set. The image displayed is square with a side length of 10^{-s} . Currently s can be between 1 and 20 but this range can easily be extended. The program currently uses 40 decimal digits after the decimal point which is certainly sufficient for all settings of s from 1 to 20. Since the images require huge amounts of computation, it is best to run the program using the native

code version of BCPL. The following two images were generated in a Pentium based laptop machine running Linux using the following shell command sequence.

```
cd $BCPLROOT/./natbcpl
make -f MakefileSDL clean
make -f MakefileSDL hdmanset
./hdmanset 10
./hdmanset 15
```

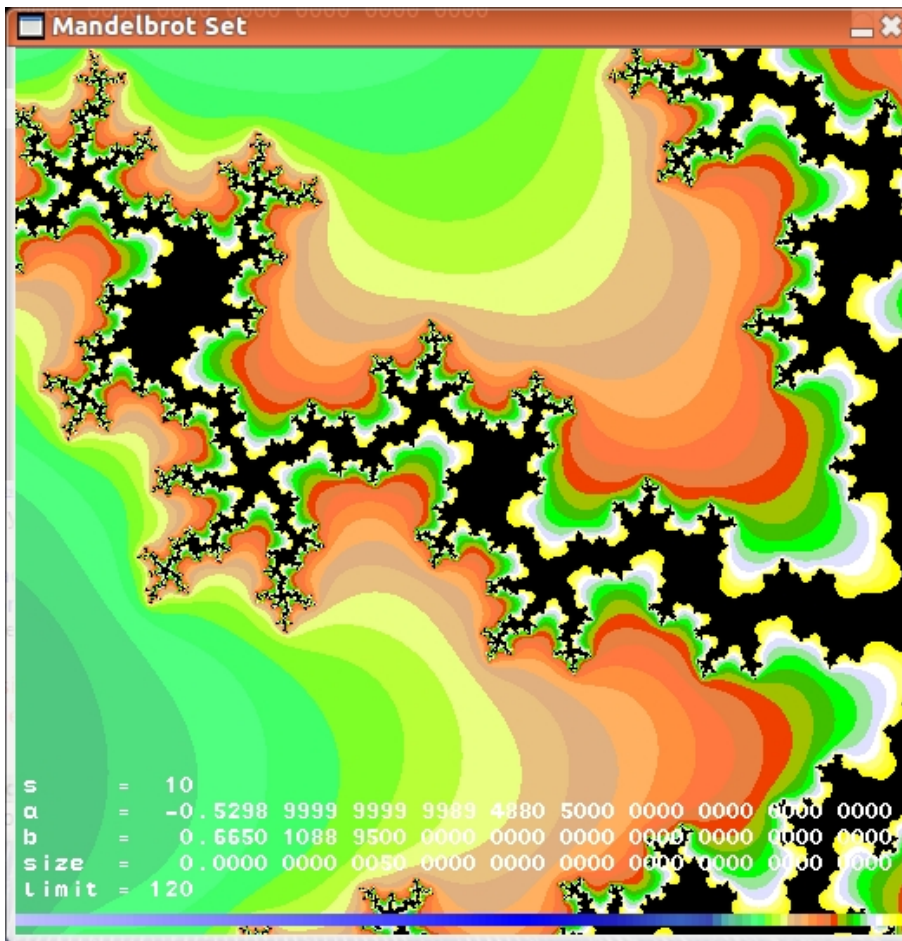
To do this on the Raspberry Pi just replace `MakefileSDL` by `MakefileRaspiSDL`. The first image is as follows.



The above image is a detailed display of a square region with a side length of 10^{-10} close to the point $c = -0.53 + 0.66i$. If one unit corresponds to one metre, the side length of this image is one Angstrom which is about the size of a hydrogen atom.

It is tempting to think of the black area as land surrounded by sea coloured to indicate its depth. Indeed, the colours have been chosen so that sea close to the coast is yellow indicating sand, then there is white representing breaking

waves and foam followed by various shades to green. At a greater distance the sea is dark blue becoming lighter as the distance increases. In between other colours are used to make the image more interesting. But thinking of this image as land surrounded by sea is unrealistic since, at this magnification, the image is one Angstrom across and a single water molecule which has a diameter of 3.2 Angstroms far too large to fit in the window.

The next image increases the magnification by a factor of 100,000 giving a detailed display of a region about the size of a proton (the nucleus of a hydrogen atom).

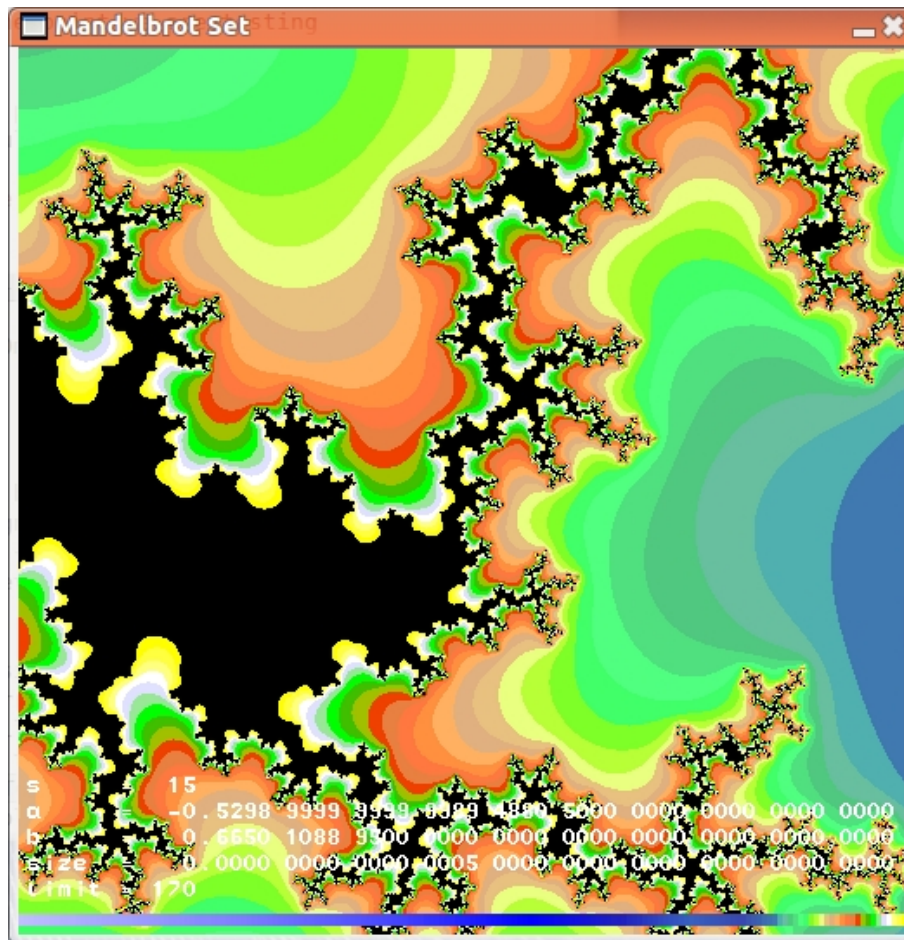

These images help to confirm that the boundary of the Mandelbrot set remains just as wiggly at whatever magnification we use. It also helps to confirm that the Mandelbrot set is *simply connected*, that is between any two points in the set there is a path lying entirely in the set that joining them.

Since computing these images take considerable time, I include thumbnail pictures of the 20 images corresponding to $s=1$ to 20. These images are all centred at $c = -0.529_899_999_999_998_948_805 + 0.665_010_889_500_000_000_000i$.

They are also available as files with names from `hdmandset01.jpg` to

hdmandset20.jpg in the directory bcplprogs/raspi.

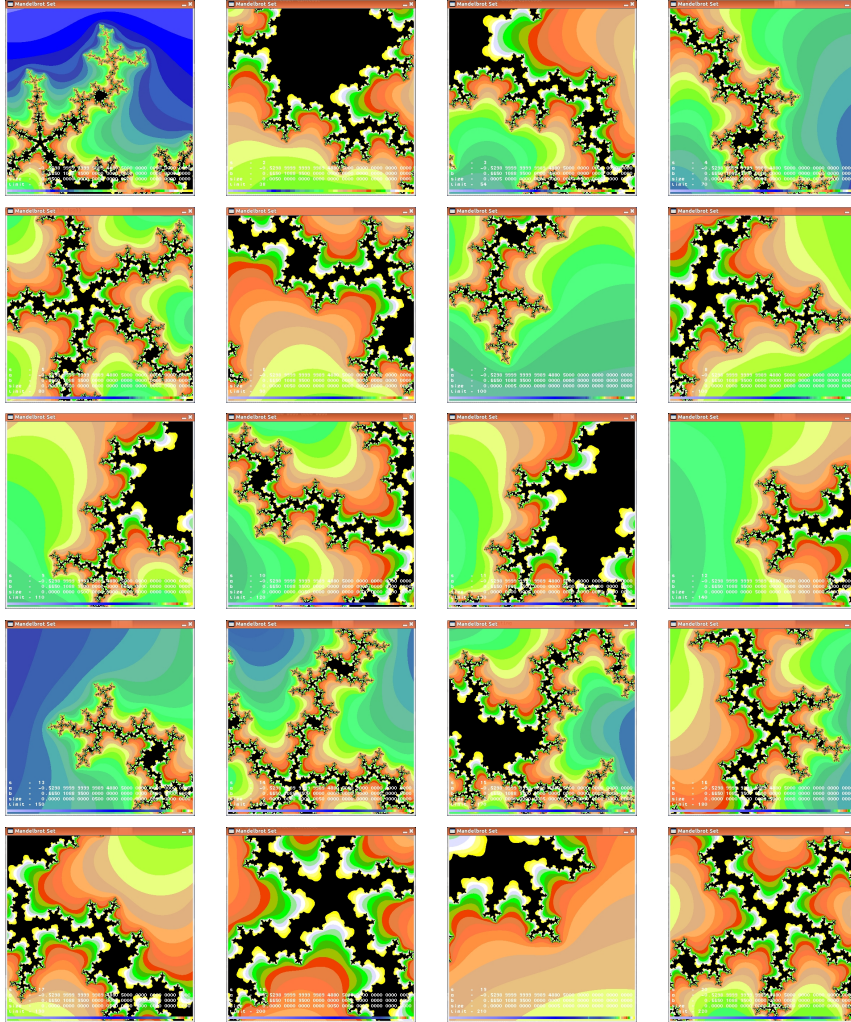

5.13 Ball and Bucket Game

This is a simple game in which the user can hit three coloured balls with a bat in an enclosed room containing a bucket placed near the ceiling. The balls bounce off each other, the walls, the floor, the ceiling and the bat, and feel the effect of gravity. The bat can only move horizontally along the floor and its motion is controlled by the left and right arrow keys. Pressing R puts all three balls in the bucket and pressing S starts the game by removing the base of the bucket until all the balls fall out. Pressing P pauses the game, and Q terminates the game. Pressing H will toggle the display of some help information, and pressing D or U causes debugging and CPU usage information to be displayed. Pressing B toggles between the user having control of the bat or the computer moving the

bat randomly. The aim of the game is to return the balls to the bucket as quickly as possible. A typical screen shot is the following.

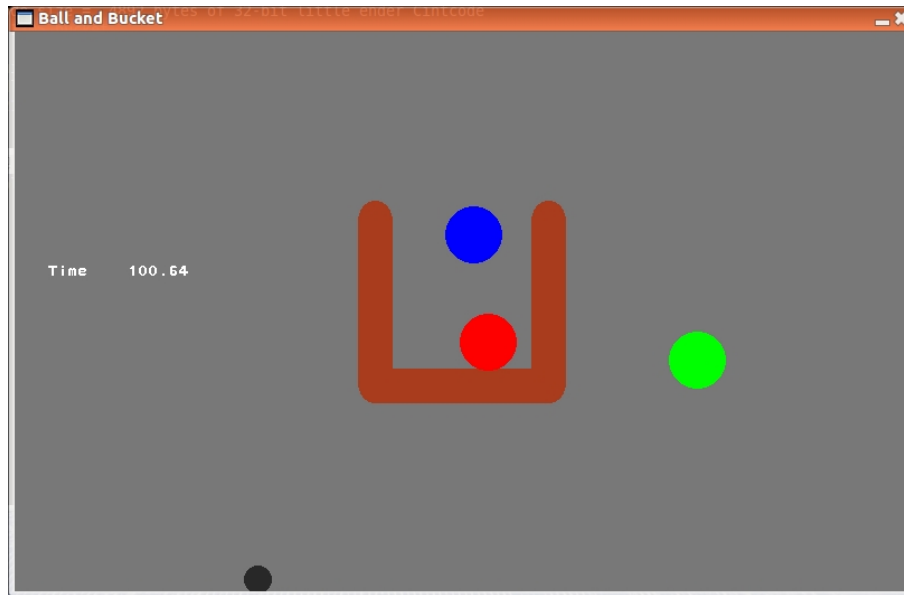

The source of the program is in `bplprogs/raspi/bucket.b` and, although quite long, most of it is easy to understand. There is code to display the static parts of the scene, namely, the bucket walls with their rounded ends and the base of the bucket. There is code to display the three balls and the bat in their current positions. There is code to deal with bouncing of the balls off each other and the bat as well as bounces off fixed surfaces such as the walls and the bucket. The game is controlled by input from the keyboard, handled by the function `processevents`. The program starts as follows.

```
/* This is a simple bat and ball game
```

```
Implemented by Martin Richards (c) February 2013
```

```
History:
```

```
17/02/2013
```

```
Successfully reimplemented the first version, bucket0.b, to  
make it much more efficient.
```

```
*/
```

```
SECTION "sdl"lib"
```

```
GET "libhdr"
```

```
GET "sdl.h"
```

```
GET "sdl.b"          // Insert the library source code
```

```
.
```

```
SECTION "bucket"
```

```

GET "libhdr"
GET "sdl.h"

MANIFEST {
  One = 1_00000 // The constant 1.000 scaled with 5 decimal
                // digits after the decimal point.
  OneK = 1000_00000

  batradius      = 12_00000
  ballradius     = 25_00000
  endradius      = 15_00000
  bucketthickness = 2 * endradius

  ag = 50_00000 // Gravity acceleration
}

GLOBAL {
  done:ug

  help // Display help information
  stepping // =FALSE if not stepping
  starting // Trap door open
  started
  finished
  randombat // If TRUE the bat is given random accelerations
  randbattime
  randbatx

  starttime // Set when starting becomes FALSE
  displaytime // Time to display
  usage
  displayusage
  debugging

  sps // Steps per second, adjusted automatically

  bucketwallsurf // Surface for the bucket walls
  bucketbasesurf // Surface for the bucket base
  ball1surf // Surfaces for the three balls
  ball2surf
  ball3surf
  batsurf // Surface for the bat

  backcolour // Background colour
  bucketcolour

```

```

bucketendcolour
ball1colour
ball2colour
ball3colour
batcolour

wall_lx      // Left wall
wall_rx      // Right wall
floor_yt     // Floor
ceiling_yb   // Ceiling

screen_xc

bucket_lxl; bucket_lxc; bucket_lxr // Bucket left wall
bucket_rxl; bucket_rxc; bucket_rxr // Bucket right wall
bucket_tyb; bucket_tyc; bucket_tyt // Bucket top
bucket_byb; bucket_byc; bucket_byt // Bucket base

// Ball bounce limits
xlim_lwall; xlim_rwall
ylim_floor; ylim_ceiling
xlim_bucket_ll; xlim_bucket_lc; xlim_bucket_lr
xlim_bucket_rl; xlim_bucket_rc; xlim_bucket_rr
ylim_topt
ylim_baseb; ylim_baset
ylim_bat

// Positions, velocities and accelerations of the balls
cgx1; cgy1; cgx1dot; cgy1dot; ax1; ay1
cgx2; cgy2; cgx2dot; cgy2dot; ax2; ay2
cgx3; cgy3; cgx3dot; cgy3dot; ax3; ay3

// Position, velocity and acceleration of the bat
batx; baty; batxdot; batydot; abatx; abaty
}

```

The first few lines insert the BCPL interface with the SDL library. This is followed by the declarations of the constants and global variables used in the program. Many quantities in this program use scaled numbers with 5 decimal digits after the decimal point. These numbers are used for the location of the fixed surfaces on the screen, the centre of gravity of the balls and bat, and their velocities and accelerations. The constant `One` represents 1.00000 in this representation. The radii of the balls and bat are held in `ballradius` and `batradius`. The bucket has circular corners whose radius is in `endradius`. The thickness of the bucket walls and the base is twice `endradius` and is held in `bucketthickness`.

The balls feel the effect of gravity whose acceleration is held in `ag`, typically set to `50_00000` representing 50 pixels per second per second.

The player can terminate the program by pressing `Q` or clicking on the little cross at the top right hand corner of the window. This sets the variable `done` to `TRUE`.

Various variables, such as `starting`, `started` and `finished`, describe the state of the game. For instance, `starting=TRUE` after the player presses `S` to place the balls in the bucket and remove its base allowing them to fall out. When the bucket becomes empty the base is re-instated and `started` becomes `TRUE`. This is the moment when the timer starts and begins to be displayed. When all three balls are returned to the bucket, `finished` is set to `TRUE` and the timer is stopped.

Pressing `B` causes the program to move the bat randomly causing the balls to be eventually returned to the bucket. It is implemented using the variables `randombat`, `randbattime` and `randbatx`. Details are given later.

Pressing `P` causes the program to pause. It is implemented by setting `stepping` to `FALSE`. Pressing `D` or `U` turn on and off the display of some debugging information.

The colour of the various objects on the screen such as the bucket, bat and balls are held in suitably mnemonic variables such as `bucketcolour` and `batcolour`.

Many variables are initialised to hold the geometry of the objects in the game. For instance `wall_lx` and `wall_rx` hold the x coordinates of the left and right wall. The y -coordinates of the ceiling and floor are held in `ceiling_yb` and `floor_yt`. The x -coordinate of the centre of the screen is held in `screen_xc`.

Variables starting `bucket_` hold the coordinates of the surfaces of the bucket.

Global variables with names starting with `xlim_` or `ylim_` are used to determine efficiently whether a ball is in contact with a fixed surface such as the side of the bucket.

The position, velocity and acceleration of the balls are held in variables such as `cgx1`, `cgy1`, `cgx1dot`, `cgy1dot`, `ax1` and `ay1`. It is important that these six values are in consecutive global locations since `@cgx1` is sometimes used as a pointer to all six values.

The bat is constrained to move horizontally in contact with the floor, but it is convenient to represent its position and velocity using the variables `batx`, `baty`, `batxdot` and `batydot`. When the bat is being moved randomly, the variable `abatx` holds its current acceleration.

An important feature of the game is how the balls bounce. Bouncing off flat surfaces such as the floor or sides of the bucket is straightforward since they are all either horizontal or vertical. Details of such bounces are covered later. When a ball collides with another ball, the bat or a circular corner of the bucket, the computation is more difficult. The two functions `incontact` and `cbounce` help to deal with these collisions. `incontact` is defined as follows.

```

LET incontact(p1,p2, d) = VALOF
{ LET x1, y1 = p1!0, p1!1
  LET x2, y2 = p2!0, p2!1
  // (x1,y1) and (x2,y2) are the centres of two circles
  // The result is TRUE if these centres are less than d apart.
  LET dx, dy = x1-x2, y1-y2
  IF ABS dx > d | ABS dy > d RESULTIS FALSE
  IF muldiv(dx,dx,One) + muldiv(dy,dy,One) >
    muldiv(d,d,One) RESULTIS FALSE
  RESULTIS TRUE
}

```

The variable `x1`, `y1`, `x2` and `y2` are declared to hold the centres of the two circles, and the function returns `TRUE` if these circles are less than a distance `d` apart. The argument `d` is the sum of the radii of the two circles involved, and so is `batradius+ballradius`, `endradius+ballradius`, `ballradius+ballradius`. With the current settings `d` can be no larger than `50_00000`. The function first checks whether the horizontal and vertical separations of the two objects are no greater than `d`. This is a cheap test and has the merit that the more detailed measurement of separation cannot suffer from overflow. The distance between the two centres is the length of the hypotenuse of a right angled triangle whose shorter sides have lengths `dx` and `dy`. Using Pythagorus' theorem the square of this length is the sum of squares of `dx` and `dy`, and so we compare this sum with the square of `d`, dividing both sides of the relation by `One=1_00000` to avoid overflow. Notice that both `dx` and `dy` are less than or equal to `50_00000` and so `muldiv(dx,dx,One) + muldiv(dy,dy,One)` can be no greater than twice `2500_00000` which is well within the range of 32-bit signed numbers. A bounce between these two objects can only occur if `incontact` returns `TRUE`. The effect of the collision is calculated by a call of `cbounce` whose definition is as follows.

```

AND cbounce(p1, p2, m1, m2) BE
{ // p1!0 and p1!1 are the x and y coordinates of a ball, bat or bucket end.
  // p1!2 and p1!3 are the corresponding velocities
  // p2!0 and p2!1 are the x and y coordinates of a ball.
  // p2!2 and p2!3 are the corresponding velocities
  // m1 and m2 are the masses of the two objects in arbitrary units
  // m2 = 0 if p1 is a bucket end.
  // m1=m2 if the collision is between two balls
  // m1=5 and m2=1 is for collisions between the bat and ball assuming the bat
  // has five times the mass of the ball.

  LET c = cosines(p2!0-p1!0, p2!1-p1!1) // Direction p1 to p2
  LET s = result2

```

```

IF m2=0 DO
{ // Object 1 is fixed, ie a bucket corner
  LET xdot = p2!2
  LET ydot = p2!3
  // Transform to (t,w) coordinates
  // where t is in the direction of the two centres
  LET tdot = inprod(xdot,ydot, c, s)
  LET wdot = inprod(xdot,ydot, -s, c)

  IF tdot>0 RETURN

  // Object 2 is getting closer so reverse tdot (but not wdot)
  // and transform back to world (x,y) coordinates.
  tdot := rebound(tdot) // Reverse tdot with some loss of energy
  // Transform back to real world (x,y) coordinates
  p2!2 := inprod(tdot, wdot, c, -s)
  p2!3 := inprod(tdot, wdot, s, c)

  RETURN
}

IF m1=m2 DO
{ // Objects 1 and 2 are both balls of equal mass
  // Find the velocity of the centre of gravity
  LET cgxdot = (p1!2+p2!2)/2
  LET cgydot = (p1!3+p2!3)/2
  // Calculate the velocity of object 1
  // relative to the centre of gravity
  LET rx1dot = p1!2 - cgxdot
  LET ry1dot = p1!3 - cgydot
  // Transform to (t,w) coordinates
  LET t1dot = inprod(rx1dot,ry1dot, c,s)
  LET w1dot = inprod(rx1dot,ry1dot, -s,c)

  IF t1dot<=0 RETURN

  // Reverse t1dot with some loss of energy
  t1dot := rebound(t1dot)

  // Transform back to (x,y) coordinates relative to cg
  rx1dot := inprod(t1dot,w1dot, c,-s)
  ry1dot := inprod(t1dot,w1dot, s, c)

  // Convert to world (x,y) coordinates
  p1!2 := rx1dot + cgxdot

```

```

p1!3 := ry1dot + cgydot
p2!2 := -rx1dot + cgxdot
p2!3 := -ry1dot + cgydot

// Apply a small repulsive force between balls
p1!0 := p1!0 - muldiv(0_40000, c, One)
p1!1 := p1!1 - muldiv(0_40000, s, One)
p2!0 := p2!0 + muldiv(0_40000, c, One)
p2!1 := p2!1 + muldiv(0_40000, s, One)

RETURN
}

{ // Object 1 is the bat and object 2 is a ball
  // Find the velocity of the centre of gravity
  LET cgxdot = (p1!2*m1+p2!2*m2)/(m1+m2)
  LET cgydot = (p1!3*m1+p2!3*m2)/(m1+m2)
  // Calculate the velocities of the two objects
  // relative to the centre of gravity
  LET rx1dot = p1!2 - cgxdot
  LET ry1dot = p1!3 - cgydot
  LET rx2dot = p2!2 - cgxdot
  LET ry2dot = p2!3 - cgydot
  // Transform to (t,w) coordinates
  LET t1dot = inprod(rx1dot,ry1dot, c,s)
  LET w1dot = inprod(rx1dot,ry1dot, -s,c)
  LET t2dot = inprod(rx2dot,ry2dot, c,s)
  LET w2dot = inprod(rx2dot,ry2dot, -s,c)

  IF t1dot<=0 RETURN

  // Reverse t1dot and t2dot with some loss of energy
  t1dot := rebound(t1dot)
  t2dot := rebound(t2dot)

  // Transform back to (x,y) coordinates relative to cg
  rx1dot := inprod(t1dot,w1dot, c,-s)
  ry1dot := inprod(t1dot,w1dot, s, c)
  rx2dot := inprod(t2dot,w2dot, c,-s)
  ry2dot := inprod(t2dot,w2dot, s, c)

  // Convert to world (x,y) coordinates
  p1!2 := rx1dot + cgxdot
  p1!3 := ry1dot + cgydot // The bat cannot move vertically
  p2!2 := rx2dot + cgxdot

```

```

p2!3 := ry2dot + cgydot

// Apply a small repulsive force
p1!0 := p1!0 - muldiv(0_05000, c, One)
p1!1 := p1!1 - muldiv(0_05000, s, One)
p2!0 := p2!0 + muldiv(0_05000, c, One)
p2!1 := p2!1 + muldiv(0_05000, s, One)

RETURN
}
}

```

This function may look complicated but is, in fact, quite easy to understand. It takes four arguments. The first, `p1` is a pointer to the locations holding the (x,y) coordinates and velocity of the first object involved in the collision, and `p2` points to the coordinates and velocity of the second object. Pointers are used since `cbounce` may need to update both the position and velocity of each object after the collision. The masses of the two objects are given in arbitrary units in `m1` and `m2`. If object 1 is a bucket corner it is given infinite mass by setting `m1=1` and `m2=0`. If the collision is between two balls, they are given equal mass by setting `m1=1` and `m2=1`, and if object 1 is the bat and object 2 is a ball, `m1` is set to 5 and `m2` is set to 1, indicating that the mass of the bat is five times that of a ball.

The direction from the centre of object 1 to the centre of object 2 is calculated by a call of `cosines` whose arguments are the horizontal and vertical displacements between the two centres. On return, the result is the cosine of the direction relative to the x axis, and `result2` holds the corresponding sine. The implementation of `cosines` is described later.

When object 1 is a bucket corner, the calculation is simple since the corner is fixed and the ball's velocity in the direction of the two centres is reversed with some energy loss. This velocity is calculated using the direction cosines by the call `inprod(xdot,ydot,c,s)`. The transverse velocity (orthogonal to the line between the centres) is calculated by the call `inprod(xdot,ydot,-s,c)`. The results are placed in `tdot` and `wdot`, respectively. If the ball is approaching the corner `tdot` will be negative, a bounce will take place implemented by replacing `tdot` with the result of `rebound(tdot)`. The inverse transformation is performed to convert the velocities back to world (x,y) coordinates.

The case when `m1=m2` is two balls of equal mass collide and its implementation is a straightforward optimisation of the general case given at the end of `cbounce` that deals with objects with different masses. We will look at this general case first.

The principles underlying this kind of collision was worked out by Isaac Newton and described in 1687 in *Principia Mathematica*. His second law states that

the acceleration \mathbf{a} of a body is parallel and directly proportional to the net force \mathbf{F} acting on the body, is in the direction of the force and is inversely proportional to the mass m of the body, i.e. $\mathbf{F} = m\mathbf{a}$. Note that we are using the standard mathematical convention that quantities that have both magnitude and direction, such as \mathbf{F} and \mathbf{a} appear in bold while those such a m that only have magnitude are non bold.

Suppose \mathbf{F} and m are such as to cause an acceleration of one foot per second per second, then applying the force for one second would increase the speed of the body by one foot per second. Applying it for two seconds would increase the speed by two feet per second. Thus if t was the length of time the force was applied and \mathbf{v} was the resulting change in velocity then $\mathbf{F}t = m\mathbf{v}$. The term $\mathbf{F}t$ is called the *impulse*, and $m\mathbf{v}$ is called the change in *momentum*. When two bodies collide they receive equal and opposite impulses so their changes in momentum are equal and opposite. The total momentum of two colliding bodies is thus unchanged by the collision. It is easy to see that the velocity of the combined centre of gravity of two objects is unaffected by the collision.

We calculate the velocity of the combined centre of gravity by declaring `cgxdot` to have value $(p1!2*m1+p2!2*m2)/(m1+m2)$ and `cgydot` to have value $(p1!3*m1+p2!3*m2)/(m1+m2)$. We then subtract this velocity from the velocities of the two objects, declaring `rx1dot`, `ry1dot`, `rx2dot` and `ry2dot` to be the velocities of the two object relative to the centre of gravity. Even though we are now in a moving frame of reference the behaviour of the objects are unchanged. After all, if you play billiards or snooker the behaviour of the balls is not affected by the fact we are travelling at a more or less uniform rate of 15 miles per second around the sun, and further more, if you play again on the same table six months later when we are on the other side of the sun, even though we are now traveling at 15 miles per second in the opposite direction.

Viewing the situation relative to the centre of gravity is a great simplification, since the centre of gravity now appears to be stationary, and the two objects are moving toward the centre of gravity until they bounce, when they will then begin moving away. At the moment of collision they each receive impulses that are equal and opposite along the line joining their centres. If there is some loss of energy during the collision the component of velocity in the direction between the centre will be reversed with its magnitude slightly reduced. We assume that the component orthogonal to this direction will be unchanged. If we call these two directions \mathbf{t} and \mathbf{w} , we can compute the velocity component of object 1 in direction \mathbf{t} by evaluating `inprod(rx1dot,ry1dot,c,s)`, calling the result `t1dot`. The component orthogonal to this is computed by `inprod(rx1dot,ry1dot,-s,c)` and given the name `w1dot`. The velocity components of the other object are computed similarly and given names `t2dot` and `w2dot`. At the moment of collision the components in direction \mathbf{t} are reversed using calls of `rebound` which also simulates a slight loss in energy. The inverse transformation is then performed to obtain the velocities after the collision of the two objects relative the centre of gravity, and finally

the velocities in real world coordinates are obtained by adding the velocity of the centre of gravity to each object. The results are then assigned to the velocity components pointed to by `p1` and `p2`. To make the packing of the balls in the bucket realistic, a small repulsive force is applied to both objects when they are in contact.

As stated earlier, the case when two balls collide (`m1=m2`) is an optimisation of this code taking advantage that the masses of the two balls are the same.

Whenever a ball bounces it loses some energy and this loss is implemented by the function `rebound`, defined below.

```
AND rebound(vel) = vel/7 - vel // Returns the rebound speed of a bounce
```

It negates the given velocity and reduces its magnitude slightly. The implementation does this by subtracting one seventh to avoid possible overflow.

When a ball collides with another ball, the bat or a round corner of the bucket, it is necessary to calculate the direction of the line joining the centres of the two objects. This direction could be represented by the angle between this line and the x -axis, but it is more convenient to represent it as the cosine and sine of this angle. These two values are often called direction cosines, and can be thought of as the coordinates of a point at the required angle on a unit circle. The function `cosines` computes them from given displacements `dx` and `dy` of the two centres in the x and y directions. This calculation could have been done by taking the inverse tangent of `dy/dx` and then computing the cosine and sine of the resulting angle, but for this program an alternative method is used.

If you think of a right angled triangle whose two shorter sides are of length `dx` and `dy` lying parallel the x and y -axes, by Pythagoras' theorem the hypotenuse will be of length $\sqrt{(dx^2 + dy^2)}$, and so the required cosine and sine will be $\frac{dx}{\sqrt{(dx^2+dy^2)}}$ and $\frac{dy}{\sqrt{(dx^2+dy^2)}}$. The function `cosines`, defined below, first reduces the size of the triangle by dividing `dx` and `dy` by the so called Manhattan distance `ABS dx + ABS dy`. This will cause the hypotenuse to have a length somewhere between about 0.7 and 1. The square of this length is placed in `a` and the approximate values of cosine and sine are held in `c` and `s`. To correct these values they must be divided by the square root of `a` which is computed to sufficient precision by just three iterations of Newton-Raphson using a well chosen initial guess. The Newton-Raphson iteration is illustrated by the following diagram.

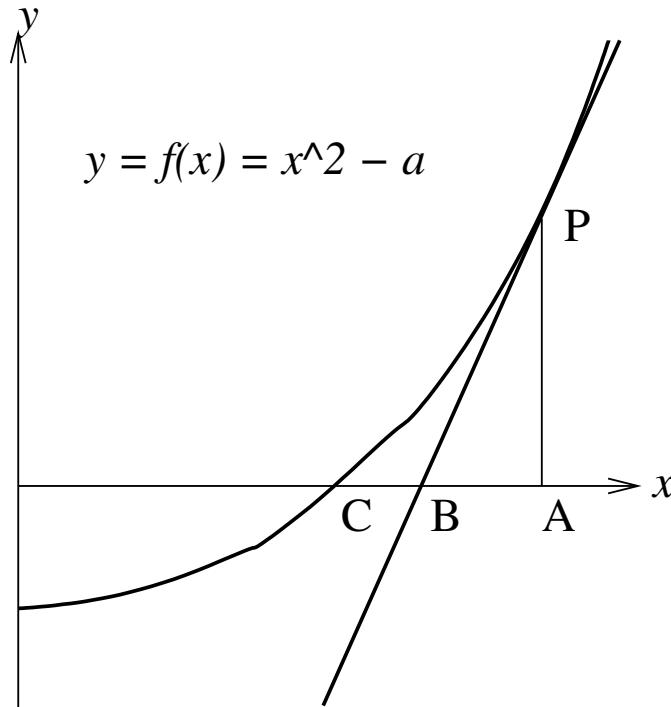

The iteration is based on the function $f(x) = x^2 - a$ which has the property that $x = \sqrt{a}$ when $f(x) = 0$. As shown in Section 5.7, the slope of $f(x)$ is its differential which, in this case, is $2x$. To find a value of d for which $f(d) = 0$ we can make a guess, say $d = 1$, corresponding to point A in the diagram, and improve it by reducing d by $f(d)$ divided by the slope of $f(x)$ at $x = d$. The new guess is then $d - (d^2 - a)/2d$ which simplifies to $(d + a/d)/2$. This step is encoded by the statement `d:=(d+muldiv(dsq,One,d))/2`. The new value of d corresponds to point B in the diagram. If you uncomment the `writeln` statements you will see how rapidly this process converges. In fact, each iteration approximately doubles the number of significant digits, so if we started with a guess that was correct to one significant place, the successive iterations would be correct to about 2, 4, 8 and 16 places. Indeed, if we did the calculation to sufficient precision, 10 iterations would give us an answer correct to about 1000 places. However, for our purposes the 4 digits of precision obtained by three iterations is sufficient. To understand this mechanism in more detail, do a web search on `newton raphson`.

The definition of `cosines` is as follows.

```

AND cosines(dx, dy) = VALOF
{ LET d = ABS dx + ABS dy
  LET c = muldiv(dx, One, d) // Approximate cos and sin
  LET s = muldiv(dy, One, d) // Direction good, length not.
  LET a = muldiv(c,c,One)+muldiv(s,s,One) // 0.5 <= a <= 1.0
  d := 1_00000 // With this initial guess only 3 iterations
              // of Newton-Raphson are required.
}

```

```

//writef("a=%8.5d d=%8.5d d^2=%8.5d*n", a, d, muldiv(d,d,One))
  d := (d + muldiv(a, One, d))/2
//writef("a=%8.5d d=%8.5d d^2=%8.5d*n", a, d, muldiv(d,d,One))
  d := (d + muldiv(a, One, d))/2
//writef("a=%8.5d d=%8.5d d^2=%8.5d*n", a, d, muldiv(d,d,One))
  d := (d + muldiv(a, One, d))/2
//writef("a=%8.5d d=%8.5d d^2=%8.5d*n", a, d, muldiv(d,d,One))

  s := muldiv(s, One, d) // Corrected cos and sin
  c := muldiv(c, One, d)
//writef("dx=%10.5d dy=%10.5d => cos=%8.5d sin=%8.5d*n", dx, dy, c, s)

  result2 := s
  RESULTIS c
}

```

The cosine is returned as the result of `cosines` and the sine is returned in the global `result2`.

If a point has coordinates (x, y) then its component in the direction specified by cosines (c, s) is $xc + ys$. This value is sometimes called the inner product of the two pairs (x, y) and (c, s) . For our scaled numbers with 5 digits after the decimal point, this calculation can be performed by calling `inprod(x,y,c,s)`. The definition of `inprod` is as follows.

```
AND inprod(dx, dy, c, s) = muldiv(dx, c, One) + muldiv(dy, s, One)
```

As the game proceeds, the window is repeatedly redrawn perhaps more often as 20 times per second to give the illusion that the bat and balls are moving smoothly. The function `step` is used to calculate the new the positions of the bat and balls for each image frame. This function uses `ballbounces` to deal with bounces between balls and the bat or fixed surfaces such as the walls or bucket. Most of `ballbounces` is easy to understand, but since it is rather long it will be described a few lines at a time. It starts as follows.

```

AND ballbounces(pv) BE
{ // This function deals with bounces between the ball whose position
  // and velocity is specified by pv and the bat or any fixed surface.
  // It does not deal with ball on ball bounces.
  LET cx, cy, vx, vy = pv!0, pv!1, pv!2, pv!3
  TEST xlim_bucket_ll <= cx <= xlim_bucket_rr &
    ylim_baseb <= cy <= ylim_topt
  THEN { // The ball cannot be in contact with the ceiling, floor or
    // either wall so we only need to check for contact with
    // the bucket

```

The argument `pv` points to consecutive locations holding the (x,y) coordinates of a ball and its velocities in the x and y directions. These are extracted and placed in the variables `cx`, `cy`, `vx` and `vy`. The `TEST` command then determines whether the ball might bounce off the bucket or the walls. The `THEN` case deals with possible bounces off the bucket.

```

IF cy > bucket_tyc DO
{ LET ecx, ecy, evx, evy = bucket_lxc, bucket_tyc, 0, 0
  IF incontact(@ecx, pv, endradius+ballradius) DO
  { cbounce(@ecx, pv, 1, 0)
    // No other bounces possible
    RETURN
  }
  ecx := bucket_rxc
  IF incontact(@ecx, pv, endradius+ballradius) DO
  { cbounce(@ecx, pv, 1, 0)
    // No other bounces possible
    RETURN
  }
  // No other bounces possible
  RETURN
}

```

If `cy` is greater `bucket_tyc`, the only possible bounces are with the two rounded tops of each side of the bucket. These are tested for and dealt with using appropriate calls of `incontact` and `cbounce`.

```

IF cy >= bucket_byc DO
{ // Possibly bouncing with bucket walls

  IF cx <= bucket_lxc DO
  { // Bounce with outside of bucket left wall
    pv!0 := xlim_bucket_ll
    IF vx>0 DO pv!2 := rebound(vx)
  }
  IF bucket_lxc < cx <= xlim_bucket_lr DO
  { // Bounce with inside of bucket left wall
    pv!0 := xlim_bucket_lr
    IF vx<0 DO pv!2 := rebound(vx)
  }
  IF xlim_bucket_rl <= cx < bucket_rxc DO
  { // Bounce with inside of bucket right wall
    pv!0 := xlim_bucket_rl
    IF vx>0 DO pv!2 := rebound(vx)
  }
}

```

```

}
IF bucket_rxc < cx DO
{ // Bounce with outside of bucket right wall
  pv!0 := xlim_bucket_rr
  IF vx<0 DO pv!2 := rebound(vx)
}
}

```

If `bucket_byc<=cy<=bucket_tyc`, the only possible bounces are with the inside or outside of the bucket walls. These four possibilities are straightforward and dealt with in turn.

```

// Bounce with base
UNLESS starting DO
{ // The bucket base is present
  IF bucket_lxc <= cx <= bucket_rxc DO
  {
    IF cy < bucket_byc DO
    { // Bounce on the outside of the base
      pv!1 := ylim_baseb
      IF vy>0 DO pv!3 := rebound(vy)
      // No other bounces are possible
      RETURN
    }
    IF bucket_byc <= cy <= ylim_baset DO
    { // Bounce on the top of the base
      pv!1 := ylim_baset
      IF vy<0 DO pv!3 := rebound(vy)
      // No other bounces are possible
      RETURN
    }
  }
}
}

```

If `starting` is `FALSE` the base of the bucket is present, and so bouncing is possible of its top or bottom surfaces. The above code deals with these two cases. If either bounce occurs no other bounces are possible, so the function returns.

```

// Bounces with the bottom corners
IF cy < bucket_byc DO
{ LET ecx, ecy, evx, evy = bucket_lxc, bucket_byc, 0, 0
  IF incontact(@ecx, pv, endradius+ballradius) DO
  { // Bounce with bottom left corner
    cbounce(@ecx, pv, 1, 0)
  }
}

```

```

        // No other bounces are possible
        RETURN
    }
    ecx := bucket_rxc
    IF incontact(@ecx, pv, endradius+ballradius) DO
    { // Bounce with bottom right corner
        cbounce(@ecx, pv, 1, 0)
        // No other bounces are possible
        RETURN
    }
}
}

```

The above code deals with bounces off the bottom two corners of the bucket, but is only reached if the ball did not bounce off the bucket base, if present. As before, these corner bounces are easy to implement using suitable calls of `incontact` and `cbounce`.

The rest of `ballbounces` deals with bounces known not to be off the bucket, and since ball on ball bounces are not performed by `ballbounces` the only possibilities are with the bat, wall, ceiling or floor. The following code deals with them all.

```

ELSE { // The ball can only be in contact with the bat, side walls,
    // ceiling or floor

    // Bouncing with the bat
    IF incontact(@batx, pv, batradius+ballradius) DO
    { pv!4, pv!5 := 0, 0
        cbounce(@batx, pv, 5, 1)
        batydot := 0 // Immediately damp out the bat's vertical motion
    }

    // Left wall bouncing
    IF cx <= xlim_lwall DO
    { pv!0 := xlim_lwall
        IF vx<0 DO pv!2 := rebound(vx)
    }

    // Right wall bouncing
    IF cx >= xlim_rwall DO
    { pv!0 := xlim_rwall
        IF vx>0 DO pv!2 := rebound(vx)
    }
}

```

```

// Ceiling bouncing
IF cy >= ylim_ceiling DO
{ pv!1 := ylim_ceiling
  IF vy>0 DO pv!3 := rebound(vy)
  // No other bounces are possible
  RETURN
}

// Floor bouncing
IF cy <= ylim_floor DO
{ pv!1 := ylim_floor
  IF vy<0 DO pv!3 := rebound(vy)
}

// No other bounces are possible
RETURN
}
}

```

Notice that the above code allowed for bounces to occur simultaneously between the ball and, say, a wall and the floor.

The function `step` is called repeatedly to update the positions of the balls and the bat. Its definition starts as follows.

```

LET step() BE
{ IF started UNLESS finished DO
  displaytime := sdlmsecs() - starttime

```

The timer starts as soon as the bucket base is reinstated after all three balls have fallen out of the bucket. It continues measuring the time until the three balls have again settled into the bucket. The variable `displaytime` holds the time measured in milli-seconds since the start. It is only updated after `started` becomes TRUE and before `finished` becomes TRUE.

The next fragment of code updates `started` to TRUE at the appropriate moment.

```

// Check whether to close the base
WHILE starting DO
{ IF ylim_baseb < cgy1 & bucket_lxc < cgx1 < bucket_rxc BREAK
  IF ylim_baseb < cgy2 & bucket_lxc < cgx2 < bucket_rxc BREAK
  IF ylim_baseb < cgy3 & bucket_lxc < cgx3 < bucket_rxc BREAK
  starting := FALSE
  started := TRUE

```

```

    finished := FALSE
    starttime := sdlmsecs()
    displaytime := 0
    BREAK
}

```

This code is not really a `WHILE` loop since its body is not repeatedly executed. It is a trick to allow the use of `BREAK` to exit from this fragment of code. The first `IF` statement executes `BREAK` if the first ball is above or possibly in contact with the bucket base and has an `x` value between the bucket walls. The second and third `IF` statements perform the same test for the other two balls. If none of these tests call `BREAK`, the game has just started causing `starting` to be set to `FALSE` and `started` to `TRUE`. The other three variables `finished`, `starttime` and `displaytime` are also initialised appropriately.

The next fragment tests whether the balls have returned to the bucket.

```

IF started UNLESS finished DO
  IF bucket_byt < cgy1 < bucket_tyb &
    bucket_lxc < cgx1 < bucket_rxc &
    bucket_byt < cgy2 < bucket_tyb &
    bucket_lxc < cgx2 < bucket_rxc &
    bucket_byt < cgy3 < bucket_tyb &
    bucket_lxc < cgx3 < bucket_rxc &
    ABS cgy1dot < 2_00000 &
    ABS cgy2dot < 2_00000 &
    ABS cgy3dot < 2_00000 DO finished := TRUE

```

It checks that the centre of each ball is within the bucket and that none of them are travelling fast enough in the `y` direction to escape. If all these tests succeed, `finished` is set to `TRUE`.

Variables, such as `ax1` and `ay1`, hold the horizontal and vertical accelerations of the balls. They are initialised by the following code.

```

// Calculate the accelerations of the balls
// Initialise and apply gravity
ax1, ay1 := 0, -ag
ax2, ay2 := 0, -ag
ax3, ay3 := 0, -ag

// Add a little random horizontal motion
ax1 := ax1 + randno(2001) - 1001
ax2 := ax2 + randno(2001) - 1001
ax3 := ax3 + randno(2001) - 1001

```

They are each given a vertical acceleration of $-ag$ simulating gravity and small random horizontal accelerations to stop balls being able to stand unrealistically in a vertical column.

The next fragments are concerned with the bouncing of the balls on any surface they come in contact with. The following code deals with the balls bouncing of the left and right hand walls.

```
ballbounces(@cgx1)
ballbounces(@cgx2)
ballbounces(@cgx3)
```

The ball on ball bounces are dealt with by the follow code. The only subtlety is that during a bounce the force of gravity are ignored by setting, for instance, `ay1` and `ay2` to zero. Since all ball have the same mass `m1` and `m2` are both given value 1.

```
// Ball on ball bounce
IF incontact(@cgx1, @cgx2, ballradius+ballradius) DO
{ ay1, ay2 := 0, 0
  cbounce(@cgx1, @cgx2, 1, 1)
}

IF incontact(@cgx1, @cgx3, ballradius+ballradius) DO
{ ay1, ay3 := 0, 0
  cbounce(@cgx1, @cgx3, 1, 1)
}

IF incontact(@cgx2, @cgx3, ballradius+ballradius) DO
{ ay2, ay3 := 0, 0
  cbounce(@cgx2, @cgx3, 1, 1)
}
```

Then follows code to updates the velocities of the three balls and their positions.

```
// Apply forces to the balls
cgx1dot := cgx1dot + ax1/Sps
cgy1dot := cgy1dot + ay1/Sps
cgx2dot := cgx2dot + ax2/Sps
cgy2dot := cgy2dot + ay2/Sps
cgx3dot := cgx3dot + ax3/Sps
cgy3dot := cgy3dot + ay3/Sps

cgx1, cgy1 := cgx1 + cgx1dot/Sps, cgy1 + cgy1dot/Sps
cgx2, cgy2 := cgx2 + cgx2dot/Sps, cgy2 + cgy2dot/Sps
cgx3, cgy3 := cgx3 + cgx3dot/Sps, cgy3 + cgy3dot/Sps
```

If B is pressed the bat moves randomly. This is implemented by setting `randombat` to `TRUE`, and then selecting a new target x position for the bat every half second. The bat always accelerates to this target. The selected target is either related to the position of the lowest ball, or is randomly chosen. The speed of the bat is limited to no more than 400 pixels per second. If the bat hits a wall it bounces without loss of energy. The y position of the bat is also given a slight correction.

```

IF randombat DO
{ LET t = sdlmsecs()
  IF t > randbattime + 0_500 DO
  { // Choose a new random target x position every 1/10 second
    LET xmax = screenxsize*0ne
    randbatx := randno(xmax)
    IF randno(1000)<500 DO
    { // About 50% of the time choose as target the x position
      // depending on the position of the lowest ball to the bat.
      LET miny = cgy1
      randbatx := cgx1
      IF cgy2<miny DO randbatx, miny := cgx2, cgy2
      IF cgy3<miny DO randbatx, miny := cgx3, cgy3
    }
    randbattime := t
  }
  TEST batx > randbatx THEN abatx := -500_00000
    ELSE abatx := 500_00000
}

// Apply forces to the bat
batxdot := batxdot + abatx/sps
IF batxdot> 600_00000 DO batxdot := 600_00000
IF batxdot<-600_00000 DO batxdot := -600_00000

batx := batx + batxdot/sps

IF batx+batradius > wall_rx DO
{ batx := wall_rx - batradius
  batxdot := -batxdot
}
IF batx-batradius < 0 DO
{ batx := batradius
  batxdot := -batxdot
}

// Slowly correct baty

```

```

    baty := baty - (baty - batradius)/10
}

```

In the first iteration of this program the bucket with or without its base, the balls and the bat were all drawn from scratch each time a new frame was displayed. This turned out to be too inefficient for the Raspberry Pi and so a more efficient implementation was chosen. This involved creating small SDL surfaces containing fragments of the scene which could be copied to the screen efficiently when needed. The fragments chosen were a wall of the bucket with its rounded ends, the three coloured balls and the bat. The corresponding surfaces are held in `bucketwallsurf`, `bucketbasesurf`, `ball1surf`, `ball2surf`, `ball3surf` and `batsurf`. They are created when needed by functions such as `initbucketwallsurf` defined below.

```

AND initbucketwallsurf() = VALOF
{ // Allocate a surface for the bucket walls
  LET width  = 2*endradius/One + 1
  LET height = (bucket_tyt - bucket_byb)/One + 2
  LET surf = mksurface(width, height)

  selectsurface(surf, width, height)
  fillsurf(backcolour)

  // Draw the ends
  TEST debugging
  THEN setcolour(bucketendcolour)
  ELSE setcolour(bucketcolour)
  drawfillcircle(endradius/One, endradius/One, endradius/One-1)
  drawfillcircle(endradius/One, height-endradius/One, endradius/One-1)

  // Draw the wall
  setcolour(bucketcolour)
  drawfillrect(0, endradius/One, width, height-endradius/One)
  RESULTIS surf
}

```

It first calculates the width and height of the fragment, and creates a surface of the size. It fills the surface with the background colour and then draws the rounded ends of the bucket wall by suitable calls of `drawfillcircle`. The wall itself is then drawn by a call of `drawfillrect`. Notice that when `debugging` is `TRUE` the circular bucket ends are given a different colour.

The coding of the other initialisation functions follow the same pattern. They are defined as follows.

```

AND initbucketbasesurf(col) = VALOF
{ // Allocate the bucket base surface
  LET height = 2*endradius/One + 1
  LET width = (bucket_rxc - bucket_lxc)/One + 1
  LET surf = mksurface(width, height)

  selectsurface(surf, width, height)
  fillsurf(backcolour)
  setcolour(bucketcolour)
  drawfillrect(0, 0, width, height)
  RESULTIS surf
}

AND initballsurf(col) = VALOF
{ // Allocate a ball surface
  LET height = 2*ballradius/One + 2
  LET width = height
  LET colkey = maprgb(64,64,64)
  LET surf = mksurface(width, height)

  selectsurface(surf, width, height)
  fillsurf(colkey)
  setcolourkey(surf, colkey)

  setcolour(col)
  drawfillcircle(ballradius/One, ballradius/One+1, ballradius/One)

  RESULTIS surf
}

AND initbatsurf(col) = VALOF
{ // Allocate a bat surface
  LET height = 2*batradius/One + 2
  LET width = height
  LET surf = mksurface(width, height)
  selectsurface(surf, width, height)
  fillsurf(backcolour)

  setcolour(batcolour)
  drawfillcircle(batradius/One, batradius/One+1, batradius/One)

  RESULTIS surf
}

```

The only subtlety is in the function `initballsurf` which uses a feature called

colour keying to cause only the circular ball to be written to the screen. The pixels outside the circle are given a special colour held in `colkey` and the call `setcolourkey(surf,colkey)` tells the surface not to copy any pixels of this colour to the screen. If you comment out the call of `setcolourkey` you will see why this call is necessary.

The next function `plotscreen` draws the entire scene. It first fills in the background colour and then checks all the required surface fragments have been created. It then copies the to the screen by calls of `blitsurf`. This function takes four arguments `src`, `dst`, `x` and `y`, where `src` and `dst` are the source and destination surfaces, and `(x,y)` is the position in the destination of where the top leftmost pixel of the source should be placed. The definition of `plotscreen` starts as follows.

```

AND plotscreen() BE
{ selectsurface(screen, screenxsize, screenysize)
  fillsurf(backcolour)

  // Allocate the surfaces if necessary
  UNLESS bucketwallsurf DO bucketwallsurf := initbucketwallsurf()
  UNLESS starting |
    bucketbasesurf DO bucketbasesurf := initbucketbasesurf()
  UNLESS ball1surf      DO ball1surf      := initballsurf(ball1colour)
  UNLESS ball2surf      DO ball2surf      := initballsurf(ball2colour)
  UNLESS ball3surf      DO ball3surf      := initballsurf(ball3colour)
  UNLESS batsurf        DO batsurf        := initbatsurf(batcolour)

  // Left bucket wall
  blitsurf(bucketwallsurf, screen, bucket_lxl/One, bucket_tyt/One)
  // Right bucket wall
  blitsurf(bucketwallsurf, screen, bucket_rxl/One, bucket_tyt/One)

  IF bucketbasesurf DO
    blitsurf(bucketbasesurf, screen, bucket_lxc/One, bucket_byt/One-1)

  // The bat
  blitsurf(batsurf, screen, (batx-batradius)/One, (baty+batradius)/One)

  IF debugging & randombat DO
  { setcolour(bucketcolour)
    drawfillcircle(randbatx/One, baty/One, 7)
  }

  // Finally, the three balls
  blitsurf(ball1surf, screen, (cgx1-ballradius)/One, (cgy1+ballradius)/One)
  blitsurf(ball2surf, screen, (cgx2-ballradius)/One, (cgy2+ballradius)/One)

```

```
blitsurf(ball3surf, screen, (cgx3-ballradius)/One, (cgy3+ballradius)/One)
```

This draws the bucket (with or without its base) the three coloured balls and the bat. All that remains is to write some text on the screen. This is done by the following code.

```
setcolour(maprgb(255,255,255))

IF finished D0
  plotf(30, 300, "Finished -- Well Done!")

IF started | finished D0
  plotf(30, 280, "Time %9.2d", displaytime/10)

IF help D0
{ plotf(30, 150, "R -- Reset")
  plotf(30, 135, "S -- Start the game")
  plotf(30, 120, "P -- Pause/Continue")
  plotf(30, 105, "H -- Toggle help information")
  plotf(30, 90, "B -- Toggle bat random motion")
  plotf(30, 75, "D -- Toggle debugging")
  plotf(30, 60, "U -- Toggle usage")
  plotf(30, 45, "Left/Right arrow -- Control the bat")
}

IF displayusage D0
  plotf(30, 245, "CPU usage = %i3%% sps = %n", usage, sps)

IF debugging D0
{ plotf(30, 220, "Ball1 x=%10.5d y=%10.5d xdot=%10.5d ydot=%10.5d",
  cgx1, cgy1, cgx1dot, cgy1dot)
  plotf(30, 205, "Ball2 x=%10.5d y=%10.5d xdot=%10.5d ydot=%10.5d",
  cgx2, cgy2, cgx2dot, cgy2dot)
  plotf(30, 190, "Ball3 x=%10.5d y=%10.5d xdot=%10.5d ydot=%10.5d",
  cgx3, cgy3, cgx3dot, cgy3dot)
  plotf(30, 175, "Bat x=%10.5d y=%10.5d xdot=%10.5d",
  batx, baty, batxdot)
}
}
```

This code uses `plotf` to write text to specified positions on the screen but otherwise should be self explanatory.

The next function initialises the position and velocity of the balls and a few other variables. Its definition is as follows.

```

AND resetballs() BE
{ cgy1 := bucket_byt+ballradius + 10_00000
  cgy2 := bucket_byt+3*ballradius + 20_00000
  cgy3 := bucket_byt+5*ballradius + 30_00000
  cgx1, cgx2, cgx3 := screen_xc, screen_xc, screen_xc
  cgx1dot, cgx2dot, cgx3dot := 0, 0, 0
  cgy1dot, cgy2dot, cgy3dot := 0, 0, 0

  starting := FALSE
  started := FALSE
  finished := FALSE
  displaytime := -1
}

```

The function `processevents` deals with input from the mouse and keyboard. Most keyboard events are simple letters detected when the key is pressed. These are all easily understood. The only subtlety is the treatment of the left and right arrow keys. An acceleration of 750_00000 is added to `abatx` while the right arrow key is held down. When it is eventually raised 750_00000 is decremented from `abatx`. Thus while the right arrow key is pressed the bat accelerates at a constant rate to the right. Similarly, the left arrow key accelerates the bat to the left.

```

AND processevents() BE WHILE getevent() SWITCHON eventtype INTO
{ DEFAULT:
  LOOP

  CASE sdle_keydown:
    SWITCHON capitalch(eventa2) INTO
    { DEFAULT: LOOP

      CASE 'Q': done := TRUE
        LOOP

      CASE '?':
      CASE 'H': help := ~help
        LOOP

      CASE 'D': debugging := ~debugging
        IF bucketwallsurf DO
        { freesurface(bucketwallsurf)
          bucketwallsurf := 0
        }
        LOOP

      CASE 'U': displayusage := ~displayusage

```

```

        LOOP

CASE 'B': randombat := ~randombat
        abatx := 0
        randbatx := screen_xc
        randbattime := 0
        LOOP

CASE 'S': // Start again
        UNLESS ylim_baseb < cgy1 & bucket_lxc < cgx1 < bucket_rxc &
            ylim_baseb < cgy2 & bucket_lxc < cgx2 < bucket_rxc &
            ylim_baseb < cgy3 & bucket_lxc < cgx3 < bucket_rxc DO
            resetballs()
            starting := TRUE
            started := FALSE
            finished := FALSE
            starttime := -1
            displaytime := -1
            IF bucketbasesurf DO
            { freesurface(bucketbasesurf)
              bucketbasesurf := 0
            }
        LOOP

CASE 'P': // Toggle stepping
        stepping := ~stepping
        LOOP

CASE 'R': // Reset the balls
        resetballs()
        finished := FALSE
        starting := FALSE
        displaytime := -1
        LOOP

CASE sdle_arrowright:
        abatx := abatx + 750_00000; LOOP
CASE sdle_arrowleft:
        abatx := abatx - 750_00000; LOOP
}

CASE sdle_keyup:
    SWITCHON capitalch(eventa2) INTO
    { DEFAULT: LOOP

```

```

CASE sdle_arrowright:
    abatx := abatx - 750_00000; LOOP
CASE sdle_arrowleft:
    abatx := abatx + 750_00000; LOOP
}

CASE sdle_quit:
    writef("QUIT*n");
    done := TRUE
    LOOP
}

```

Notice that the surface fragment `bucketballsurf` must be cleared when `D` is pressed since toggling the debugging flag causes the colour of the bucket ends to change. Similarly, `bucketbasesurf` must be cleared when `S` is pressed.

The final function `start` is the main program. It initialises all the required variables and then enters the event loop to repeatedly read events, update the state of the balls and bat and display the result. If you comment out the `IF FALSE DO` line near the top, code will run to test the `cosines` function. This was a debugging aid used to ensure the `cosines` behaved correctly.

```

LET start() = VALOF
{ LET stepmsecs = ?
  LET comptime = 0 // Amount of cpu time per frame

  UNLESS sys(Sys_sdl, sdl_avail) DO
  { writef("nThe SDL features are not available*n")
    RESULTIS 0
  }

  bucketwallsurf := 0
  bucketbasesurf := 0
  ball1surf := 0
  ball2surf := 0
  ball3surf := 0
  batsurf := 0

  IF FALSE DO
  { // Code to test the cosines function
    LET e1, e2 = One, One
    FOR dy = 0 TO One BY One/100 DO
    { LET c, s, rsq = ?, ?, ?
      c := cosines(One, dy)
    }
  }
}

```

```

    s := result2
    rsq := muldiv(c,c,One) + muldiv(s,s,One)
    writef("dx=%9.5d dy=%9.5d cos=%9.5d sin=%9.5d rsq=%9.5d*n",
           One, dy, c, s, rsq)
    IF e1 < rsq DO e1 := rsq
    IF e2 > rsq DO e2 := rsq
  }
  writef("Errors +%6.5d  -%7.5d*n", e1-One, One-e2)
  RESULTIS 0
}

initsdl()
mkscreen("Ball and Bucket", 800, 500)

help := TRUE

randobat := FALSE
randbatx := screen_xc
randbaty := 0

stepping := TRUE      // =FALSE if not stepping
starting := TRUE      // Trap door open
started := FALSE
finished := FALSE
starttime := -1
displaytime := -1
usage := 0
debugging := FALSE
displayusage := FALSE
sps := 40 // Initial setting
stepmsecs := 1000/sps

backcolour      := maprgb(120,120,120)
bucketcolour    := maprgb(170, 60,  30)
bucketendcolour := maprgb(140, 30,  30)
ball1colour     := maprgb(255,  0,  0)
ball2colour     := maprgb(  0,255,  0)
ball3colour     := maprgb(  0,  0, 255)
batcolour       := maprgb( 40, 40,  40)

wall_lx := 0
wall_rx := (screenxsize-1)*One // Right wall

floor_yt := 0 // Floor
ceiling_yb := (screenysize-1)*One // Ceiling

```

```

screen_xc := screenxsize*One/2
bucket_tyt := ceiling_yb - 6*ballradius
bucket_tyc := bucket_tyt - endradius
bucket_tyb := bucket_tyt - bucketthickness

bucket_lxr := screen_xc - ballradius * 5 / 2
bucket_lxc := bucket_lxr - endradius
bucket_lxl := bucket_lxr - bucketthickness

bucket_rxl := screen_xc + ballradius * 5 / 2
bucket_rxc := bucket_rxl + endradius
bucket_rxr := bucket_rxl + bucketthickness

bucket_byt := bucket_tyt - 6*ballradius
bucket_byc := bucket_byt - endradius
bucket_byb := bucket_byt - bucketthickness

xlim_lwall := wall_lx + ballradius
xlim_rwall := wall_rx - ballradius
ylim_floor := floor_yt + ballradius
ylim_ceiling := ceiling_yb - ballradius
xlim_bucket_ll := bucket_lxl - ballradius
xlim_bucket_lc := bucket_lxc - ballradius
xlim_bucket_lr := bucket_lxr + ballradius
xlim_bucket_rl := bucket_rxl - ballradius
xlim_bucket_rc := bucket_rxc - ballradius
xlim_bucket_rr := bucket_rxr + ballradius
ylim_topt := bucket_tyt + ballradius
ylim_baseb := bucket_byb - ballradius
ylim_baset := bucket_byt + ballradius

resetballs()

ax1, ay1 := 0, 0 // Acceleration of ball 1
ax2, ay2 := 0, 0 // Acceleration of ball 2
ax3, ay3 := 0, 0 // Acceleration of ball 3

batx := screen_xc // Position of bat
baty := floor_yt + batradius // Position of bat
ylim_bat := floor_yt + batradius + ballradius

batxdot, batydot := 150_00000, 0 // Velocity of bat
abatx := 0 // Acceleration of bat

```



```

done := FALSE

UNTIL done DO
{ LET t0 = sdlmsecs()
  LET t1 = ?

  processevents()

  IF stepping DO step()

  usage := 100*comptime/stepmsecs
  plotscreen()
  updatescreen()
  UNLESS 80<usage<95 DO
  { TEST usage>90
    THEN sps := sps-1
    ELSE sps := sps+1
    stepmsecs := 1000/sps
  }

  t1 := sdlmsecs()

  comptime := t1 - t0
  IF t0+stepmsecs > t1 DO sdldelay(t0+stepmsecs-t1)
}

writef("*nQuitting*n")
sdldelay(1_000)

IF bucketwallsurf DO freesurface(bucketwallsurf)
IF bucketbasesurf DO freesurface(bucketbasesurf)
IF ball1surf      DO freesurface(ball1surf)
IF ball2surf      DO freesurface(ball2surf)
IF ball3surf      DO freesurface(ball3surf)
IF batsurf        DO freesurface(batsurf)

closesdl()
RESULTIS 0
}

```

Although the Cintcode interpretive system runs this program reasonably well, you can improve its efficiency by compiling the BCPL into native machine code for the ARM processor. On the Raspberry Pi, try getting into the directory `BCPL/natbcpl` then typing the following.

```
make -f MakefileRaspiSDL clean
```

```
make -f MakefileRaspiSDL bucket
./bucket
```

With luck this should run the bucket program with a frame rate of about 25 frames per second.

5.14 The A* Algorithm

A weighted graph consists of a collection of nodes some of which are connected by edges having associated costs. Such a graph can be used to represent a road network connecting towns, with the costs being the distance along the roads between the towns. It is natural to wonder how the cheapest route between two towns can be found. In 1958 the famous Dutch Computer Scientist, Edsger Dijkstra, published an algorithm to solve this problem. His method is now known as Dijkstra's algorithm. Later, a variant of his algorithm called the A* algorithm, was discovered. It uses a heuristic function giving a minimum possible cost from any node to the goal. Such a function is not always possible, but for graphs representing road networks it is, for instance the straight line distance between a town and the goal would be a suitable heuristic. When applicable the A* algorithm is usually significantly faster than Dijkstra's algorithm.

This section presents a program that implements the A* algorithm applied to a rectangular array of square cells. It has randomly chosen start and goal cells. The cost of moving to a diagonally adjacent cell is taken to be 14 and to a horizontally or vertically adjacent cell is 10. These being approximate distances between the cell centres in arbitrary units. Some cells represent walls that block the path, but most cells are marked initially as Unvisited. As the algorithm proceeds the minimum distance of a cell from the start cell may become known. Such a cell is marked as Closed. Other cells, called fringe cells, are adjacent to closed cells, but have not yet been fully processed so their minimum distance from the start cell is not yet known. All other cells are either marked as Unvisited or Wall. Closed cells have their distances from the start cell held in the **g** field of the cell node. Fringe cells also have a **g** value, but it holds the cost of the shortest path to the start cell so far discovered. A cheaper path may be found later. Its **g** value will always be either 10 or 14 greater than the **g** value of an immediate closed neighbour. A fringe cell also has an **f** value which is the sum of its **g** value and the cell's heuristic value, typically the straight line distance from it to the goal.

The algorithm repeatedly extracts a fringe cell with the minimum **f** value. It marks it as Closed and then looks at its 8 immediate neighbours. Closed or Wall cells are ignored. Unvisited cells become Fringe cells with suitably computed **g** and **f** values. If the neighbour was a fringe cell, it is possible that the path via the current closed cell gives a smaller **g** value. This causes its **g** and **f** values to

reduce. The algorithm terminated when the goal cell becomes marked as Closed and its g value will be its minimum distance from the start cell. The algorithm also terminates if the set of Fringe cells is empty, but this only happens if there is no possible route from the start cell to the goal.

One subtlety of the algorithm is how to represent the set of fringe cells. The operations required are (1) add a new cell to the set, (2) extract a cell with the minimum f value from the set, and (3) reduce the f value of a cell that is already in the set. The mechanism required is called a priority queue and there are many ways it implement it. The simplest scheme is to use a linear list ordered by f value, but this is extremely inefficient if the fringe ever contains millions of cells. A near optimal scheme is to use a structure called a Fibonacci Heap but this is hard to program and difficult to understand. For reasonably small fringe sizes a priority queue based on the heap structure used in heap sort is far simpler and adequately efficient. This is the version used in this demonstration. Its implementation is described later.

When the program is run, it produces an animated display showing how the algorithm works. A typical screen image is the following.

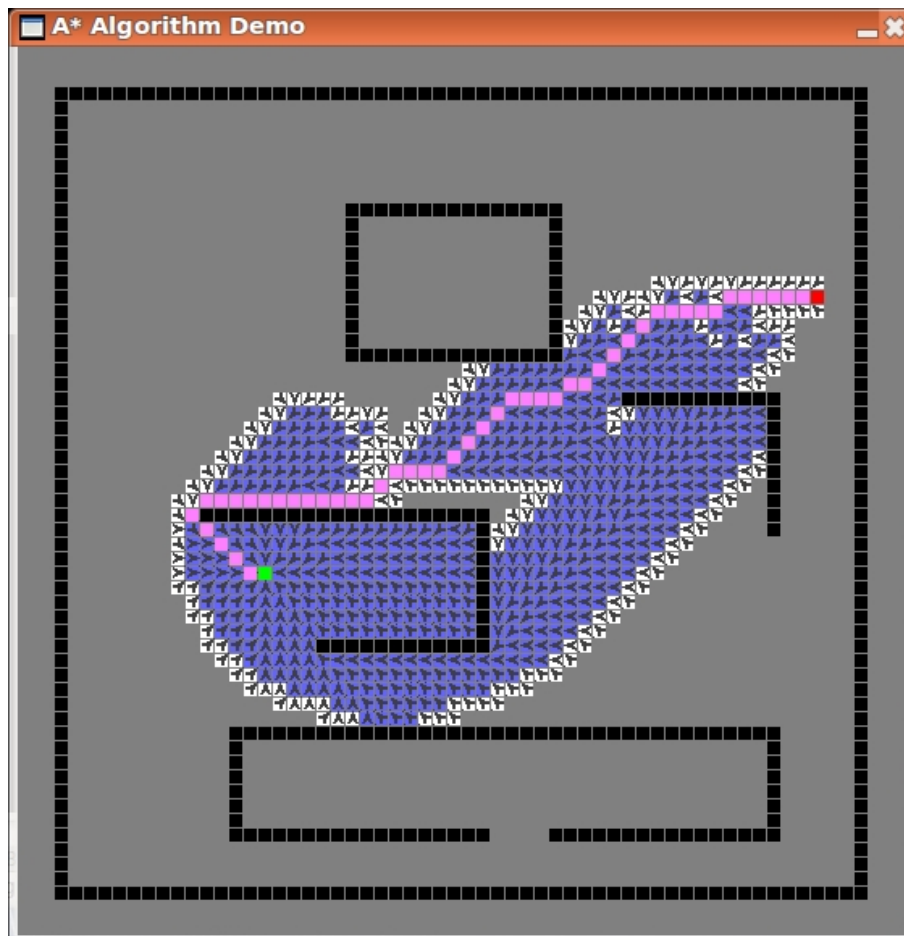

The start cell is green and the goal is red. Every Closed cell except for the start and goal is blue and contains a arrow pointing to the next cell on the shortest path towards the start cell. This is determined by the `frompos` field in the cell's node. Every Fringe cell is white and contains an arrow to the next cell of the shortest path currently discovered to the start cell. Once the shortest path to the goal is found, all cells on the path are coloured light majenta. Unvisited cells are gray and Wall cells are black. The program runs the algorithm 50 times with different random start and goal cells.

If the program is run with the `-d` option, every cell is given the same heuristic value causing the A* algorithm to behave like Dijkstra's algorithm. You can use the `-m` command option to specify a delay in milli-seconds every time the state a a cell changed. This allows the detailed working of the algorithm to be inspected.

The program is called `bcplprogs/raspi/astar.b` and is as follows.

```
/*
This is a demonstration of the well known A* algorithm for finding the
shortest path between two cells on a 2D grid in which some cells must
be avoided.
```

```
Implemented in BCPL by Martin Richards (c) 23 Jan 2017
```

```
Usage: -m=msecs/n,-s=seed/n,-t=tracing/s,-d=dijkstra/s
```

```
-m/n      Delay time in msec between steps.
-s/n      The random number seed, used to select the start and goal
          positions. Small values select some hand chosen positions.
-t/s      Turn on tracing.
-d/s      Perform Dijkstra's algorithm rather than A*
```

```
History
```

```
24/12/2016
```

```
Changed cell size from 5x5 to 9x9 so that backtracking arrow
are more visible.
```

```
*/
```

```
SECTION "sdl"
GET "libhdr"
GET "sdl.h"
GET "sdl.b"          // Insert the library source code
.
SECTION "astar"
GET "libhdr"
GET "sdl.h"
```

```

MANIFEST {
  Unvisited=0 // Undiscovered cell
  Fringe      // Discovered cell still being evaluated
  Closed      // Evaluated cell
  Wall        // A cell blocking the path
  Path        // =TRUE if on the shortest path to the goal

  // Cell node selectors
  s_state=0   // = Unvisited, Fringe, Closed or Wall
  s_pos       // position of the cell in the vector areav
  s_frompos   // position of the best predecessor cell
  s_g         // The shortest path distance from the start cell
  s_f         // The g value + the shortest distance to the goal ignoring walls
  s_priqpos   // The position of this cell in the priority queue, or zero.

  s_size
  s_upb=s_size-1

  csize=9     // cells are now 9x9 (no longer 5x5)
}

GLOBAL {
  stdin:ug
  stdout
  tracing
  delaytime
  randseed
  dijkstra // =TRUE if performing Dijkstra'a algorithm

  dijkstra_heuristic
  astar_heuristic
  heuristic

  spacevupb // The upper bound of spacev
  spacev    // Vector of free storage
  spacep    // Point to the most recent subvector allocated
  spacet    // The limit of spacev
  areav     // A 2D array of cell nodes

  xsize     // Number of cells per row, somewhat less than screenxsize
  ysize     // Number of cells per column

  priq      // The heap structure used to represent the priority queue
  priqn     // The number of cells in the priority queue
  priqnmax  // The largest value of priqn used

```

```
priqub // The maximum possible number of cells in the priority queue

getleast // Function to extract the cell with the least f value from
         // the priority queue
insert // Insert a cell into the priority queue
positioncell // (cell, p) Reposition the cell at position p since
            // its f value has just been reduces.
chkpriq // Check that the priority queue structure is valid.
prpriq // Output the priority queue showing its structure.
indent // Output the indent character (used by prpriq)

newvec // Allocate space from spacev
newcell // Allocate a cell node

startcell
goalcell

position // (x,y) calculate the position of a cell in areav
allocarea
plotarea
cellcolour

findshortestpath
neighbourcost
drawwall
plotcell

col_black
col_blue
col_green
col_yellow
col_red
col_majenta
col_cyan
col_white
col_darkgray
col_darkblue
col_darkgreen
col_darkyellow
col_darkred
col_darkmajenta
col_darkcyan
col_gray
col_lightgray
col_lightblue
```

```

col_lightgreen
col_lightyellow
col_lightred
col_lightmagenta
col_lightcyan
}

LET start() = VALOF
{ LET argv = VEC 50

  spacev, priq := 0, 0

  UNLESS rdargs("-m=msecs/n,-s=seed/n,-t=tracing/s,-d=dijkstra/s",
               argv, 50) DO
  { writef("Bad arguments for astar*n")
    GOTO fin
  }

  delaytime := 0 // msec
  randseed := 0 // Used to select the start and goal positions

  IF argv!0 DO delaytime := !argv!0 // -m=msecs/n
  IF argv!1 DO randseed := !argv!1 // -s=seed/n
  tracing := argv!2 // -t=tracing/s
  dijkstra := argv!3 // -d=dijkstra/s

  IF tracing DO writef("delaytime=%7.3d randseed=%n dijkstra=%n*n",
                      delaytime, randseed, dijkstra)

  spacevupb := 30_000
  spacev := getvec(spacevupb)
  priqupb := 500
  priq := getvec(priqupb)

  initsdl()

  TEST dijkstra
  THEN { mkscreen("Dijkstra's Algorithm Demo", 550, 550)
        heuristic := dijkstra_heuristic
      }
  ELSE { mkscreen("A** Algorithm Demo", 550, 550)
        heuristic := astar_heuristic
      }

  // The calls of mkscreen above sets screenxsize and
  // screenysize both to 550.

```

```

xsize := screenxsize/csize - 5 // The number of cells in a row
ysize := screensize/csize - 5 // The number of cells in a column

// Define some colours
col_black      := maprgb( 0,  0,  0)
col_blue       := maprgb( 0,  0, 255)
col_green      := maprgb( 0, 255,  0)
col_yellow     := maprgb( 0, 255, 255)
col_red        := maprgb(255,  0,  0)
col_majenta    := maprgb(255,  0, 255)
col_cyan       := maprgb(255, 255,  0)
col_white      := maprgb(255, 255, 255)
col_darkgray   := maprgb( 64,  64,  64)
col_darkblue   := maprgb(  0,  0,  64)
col_darkgreen  := maprgb(  0,  64,  0)
col_darkyellow := maprgb(  0,  64,  64)
col_darkred    := maprgb(128,  0,  0)
col_darkmajenta := maprgb( 64,  0,  64)
col_darkcyan   := maprgb( 64,  64,  0)
col_gray       := maprgb(128, 128, 128)
col_lightblue  := maprgb(100, 100, 255)
col_lightgreen := maprgb(100, 255, 100)
col_lightyellow := maprgb(128, 255, 255)
col_lightred   := maprgb(255, 128, 128)
col_lightmajenta := maprgb(255, 128, 255)
col_lightcyan  := maprgb(255, 255, 128)

FOR i = 1 TO 50 DO // Perform 50 random tests
{ spacet := spacev + spacevupb
  spacep := spacet

  priqn := 0
  priqnmax := 0

  // Allocate areav and all cells
  // and also initialise the wall cells
  // Display the result.
  // Note that the other cells are displayed as they change.

  writef("*nSeed = %n*n", randseed)

  allocarea() // Initialise the area and place the walls.

  selectstartandgoal(randseed)

```



```

    plotcell(startcell)
    plotcell(goalcell)

    // Run the A* or Dijkstra algorithm
    findshortestpath(startcell, goalcell)

    writef("Space used %n out of %n*n", spacet-spacep, spacevupb)
    writef("Priority queue used %n out of %n*n", priqnmax, priqupb)

    slddelay(10_000) // Delay between tests to allow the solution
                    // to be viewed.

    randseed := randseed+1
}

fin:
    closesdl()
    IF spacev DO freevec(spacev)
    IF priq   DO freevec(priq)

    writef("*nEnd of test*n")
    RESULTIS 0
}

AND prcell(cell) BE
{ writef("[%n (%i3,%i3) (%i3,%i3) %n+%n=%n]*n",
        s_state!cell,
        xcoord(s_pos!cell), ycoord(s_pos!cell),
        xcoord(s_frompos!cell), ycoord(s_frompos!cell),
        s_g!cell, heuristic(cell, goalcell), s_f!cell)
}

AND selectstartandgoal() BE
{ LET goalx, goaly = 0, 0
  LET startx, starty = 0, 0

  SWITCHON randseed INTO
  { DEFAULT: ENDCASE

    CASE 0: startx, starty := 14, 22
            goalx, goaly  := 52, 41
            ENDCASE

    CASE 1: startx, starty := 15, 22
            goalx, goaly  := 46, 40

```

```

        ENDCASE
CASE 2:  startx, starty := 22, 42
        goalx, goaly  := 36, 15
        ENDCASE
CASE 3:  startx, starty := 47, 25
        goalx, goaly  :=  5, 30
        ENDCASE
CASE 4:  startx, starty := 30, 15
        goalx, goaly  := 25, 53
        ENDCASE
CASE 5:  startx, starty := 10, 45
        goalx, goaly  := 38, 19
        ENDCASE
}

{ LET pos = position(startx, starty)
  startcell := areav!pos
  // Ensure that the start cell is Unvisited.
  IF s_state!startcell = Unvisited BREAK
  startx, starty := randno(xsize-1), randno(ysize-1)
} REPEAT

{ LET pos = position(goalx, goaly)
  goalcell := areav!pos
  // Ensure that the goal cell is Unvisited
  // and not too close to the start cell.
  IF s_state!goalcell = Unvisited &
    ABS(startx-goalx) + ABS(starty-goaly) > 40 BREAK
  goalx, goaly := randno(xsize-1), randno(ysize-1)
} REPEAT

writef("start=(%n,%n) goal=(%n,%n) dist=%n*n",
      startx, starty,
      goalx, goaly,
      ABS(startx-goalx) + ABS(starty-goaly))
}

AND findshortestpath(startcell, goalcell) = VALOF
{ // Return FALSE if no path exists

  setseed(randseed)

  s_state!startcell := Fringe

  s_frompos!startcell := -1      // The start cell has no predecessor

```

```

s_g!startcell := 0
s_f!startcell := heuristic(startcell, goalcell)
insert(startcell) // Put it in the priority queue

plotcell(startcell)
//chkpriq() // Debugging check

{ // Start of main loop
  LET currentcell = getleast()

  UNLESS currentcell DO
  { writef("The goal cannot be reached from the start cell*n")
    RESULTIS FALSE // No path exists
  }

  IF currentcell=goalcell DO
  { writef("Shortest path found*n")
    createpath(goalcell, startcell)
    RESULTIS TRUE
  }

  // Close the current cell
  s_state!currentcell := Closed
  plotcell(currentcell)
  //chkpriq() // Debugging check

  // Look at the 8 immediate neighbours of the current cell

  { LET pos = s_pos!currentcell
    LET g = s_g!currentcell
    LET tg, newf = ?, ?

    FOR dx = -1 TO 1 FOR dy = -1 TO 1 UNLESS dx=0=dy DO
    { LET npos = pos + dy*xsize + dx // Position of an immediate neighbour
      LET cell = areav!npos
      LET state = s_state!cell

      // Ignore neighbours that are walls or are already evaluated
      IF state = Closed | state = Wall LOOP

      tg := g + neighbourcost(dx, dy)

      IF state = Unvisited DO
      { s_state!cell := Fringe // Make this cell a Fringe cell
        s_g!cell := tg

```

```

s_f!cell := tg + heuristic(cell, goalcell)
s_frompos!cell := pos

insert(cell) // Insert this cell into the priority queue
plotcell(cell)
//chkpriq() // Debugging check
IF tracing DO
{ writef("*nNew fringe cell created "); pcell(cell)
  ppriq(1, 0, 0)
  abort(1000)
}
sdldelay(delaytime)
LOOP
}

UNLESS state = Fringe DO
{ writef("System error: this cell should be a Fringe cell "); pcell(cell)
  abort(999)
}

IF tg >= s_g!cell LOOP // There is already a cheaper route

// We have found a shorter route to this Fringe cell
s_frompos!cell := pos
s_g!cell := tg
s_f!cell := tg + heuristic(cell, goalcell)
positioncell(cell, s_priqpos!cell) // Re-position cell in the queue
plotcell(cell)
//chkpriq() // Debugging check

IF tracing DO
{ writef("*nf value of a fringe cell decreased "); pcell(cell)
  ppriq(1, 0, 0)
  abort(1000)
}

sdldelay(delaytime)
// Consider the next neighbour, if any
}
}
// Deal with another Fringe cell
} REPEAT
}

```

```

AND createpath(p, q) BE
{ UNTIL p=q DO
  { p := areav!(s_frompos!p)
    s_state!p := Path
    plotcell(p)
  }
}

AND newvec(upb) = VALOF
{ LET p = spacep - upb - 1
  IF p < spacev DO
    { writef("More space needed*n")
      abort(999)
      RESULTIS 0
    }
    spacep := p
    RESULTIS p
  }
}

AND newcell() = VALOF
{ LET cell = newvec(s_upb)

  s_state!cell := Unvisited
  s_pos!cell := -1 // Not yet in the area
  s_frompos!cell := -1 // No from cell yet
  s_g!cell := -1 // Not yet visited
  s_f!cell := -1 // Unset value
  s_priqpos!cell := 0 // Not in the priority queue

  RESULTIS cell
}

// Note that x and y are in the range 0 to xsize and 0 to ysize.
AND position(x, y) = y * xsize + x
AND xcoord(pos) = pos MOD xsize
AND ycoord(pos) = pos / xsize

AND neighbourcost(dx, dy) = dx=0 | dy=0 -> 10, 14

AND allocarea() BE
{ // Allocate areav and create all cell node
  // and initialise the wall.
  // Finally display the area and its walls.
  // Note that the cells are displayed later as they change.

```

```

spacep := spacet          // Allocate a brand new area
areav := newvec(position(xsize-1, ysize-1))

IF tracing D0
  writef("areav=%n upb=%n*n", position(xsize-1,xsize-1))

FOR x = 0 TO xsize-1 FOR y = 0 TO ysize-1 DO
{ LET pos = position(x, y)
  LET cell = newcell()
  s_pos!cell := pos      // The position of this cell in areav
  s_frompos!cell := -1 // No from cell yet
  s_g!cell := -1        // g value unset
  s_f!cell := -1        // f value unset
  s_priqpos!cell := 0   // The cell is not in the priority queue
  areav!pos := cell
}

fillsurf(col_gray) // Fill the area background colour

// Fill in the outside walls
drawwall( 0, 0, 56, 1) // Base wall
drawwall( 0, 55, 56, 56) // Top wall
drawwall( 0, 1, 1, 56) // Left wall
drawwall( 55, 1, 56, 56) // Right wall

drawwall( 20, 47, 35, 48) // #####
drawwall( 20, 38, 21, 47) // # #
drawwall( 34, 38, 35, 47) // # #
drawwall( 20, 37, 35, 38) // #####

drawwall( 39, 34, 50, 35) // #####
drawwall( 49, 25, 50, 34) // #
// #
// ##### #
drawwall( 10, 26, 30, 27) // #
drawwall( 29, 18, 30, 26) // #
drawwall( 18, 17, 30, 18) // #####

drawwall( 12, 11, 50, 12) // #####
drawwall( 12, 5, 13, 11) // # #
drawwall( 49, 5, 50, 11) // # #
drawwall( 12, 4, 30, 5) // #####
drawwall( 34, 4, 50, 5) // #####
}

```

```

AND drawwall(x1,y1, x2,y2) BE
{ // The coordinates are all in the range 0 to 56

  FOR x = x1 TO x2-1 FOR y = y1 TO y2-1 DO
  { LET cell = areav!position(x,y)
    IF cell<0 DO
    { writef("drawwall: System error x=%n y=%n*n", x, y)
      abort(999)
    }
    s_state!cell := Wall
    plotcell(cell)
  }
}

AND drawpoints(x, y, bits) BE
{ x := x+8
  WHILE bits DO
  { UNLESS (bits&1)=0 DO drawpoint(x, y)
    x, bits := x-1, bits>>1
  }
}

AND plotcell(cell) BE
{ LET pos = s_pos!cell
  LET x = xcoord(pos)
  LET y = ycoord(pos)
  LET dir = -1
  LET frompos = s_frompos!cell

  LET px = (screenxsize-csize*xsize)/2 + csize*x
  LET py = (screenysize-csize*ysize)/2 + csize*y

  LET col = cellcolour(cell)
  IF cell=startcell DO col := col_green
  IF cell=goalcell DO col := col_red

  IF x > xsize | y > ysize DO
  { writef("plotcell: x=%n y=%n out of range*n", x, y)
    abort(999)
    RETURN
  }

  UNLESS s_state!cell=Path IF frompos>=0 DO
  { LET fx = xcoord(frompos)
    LET fy = ycoord(frompos)

```

```

LET dx = fx - x
LET dy = fy - y
dir := (dy+1)*3 + dx + 1 // dir      6 7 8
                          // towards 3 4 5
                          // parent  0 1 2
}
setcolour(col)
drawfillrect(px, py, px+(csize-2), py+(csize-2))
setcolour(col_darkgray)
UNLESS cell=goalcell SWITCHON dir INTO
{ DEFAULT:
  CASE -1:
    ENDCASE
  CASE 0: // Down left
    drawpoints(px, py+8, #b_0_0_0_0_0_0_0_0_0) // 8 + + + + + + + +
    drawpoints(px, py+7, #b_0_0_0_1_1_0_0_0_0) // 7 + + + # # + + + +
    drawpoints(px, py+6, #b_0_0_0_1_1_0_0_0_0) // 6 + + + # # + + + +
    drawpoints(px, py+5, #b_0_0_0_1_1_0_0_0_0) // 5 + + + # # + + + +
    drawpoints(px, py+4, #b_0_0_1_1_1_1_1_1_0) // 4 + + # # # # # # +
    drawpoints(px, py+3, #b_0_0_1_1_1_1_1_1_0) // 3 + + # # # # # # +
    drawpoints(px, py+2, #b_0_1_1_1_1_0_0_0_0) // 2 + # # # # + + + +
    drawpoints(px, py+1, #b_0_1_1_0_0_0_0_0_0) // 1 + # # + + + + + +
    drawpoints(px, py+0, #b_1_0_0_0_0_0_0_0_0) // 0 # + + + + + + + +
    ENDCASE
  CASE 1: // Down
    drawpoints(px, py+8, #b_0_0_0_0_0_0_0_0_0) // 8 + + + + + + + +
    drawpoints(px, py+7, #b_0_1_1_0_0_0_1_1_0) // 7 + # # + + + # # +
    drawpoints(px, py+6, #b_0_0_1_1_0_1_1_0_0) // 6 + + # # + # # + +
    drawpoints(px, py+5, #b_0_0_1_1_0_1_1_0_0) // 5 + + # # # # # + +
    drawpoints(px, py+4, #b_0_0_0_1_1_1_0_0_0) // 4 + + + # # # + + +
    drawpoints(px, py+3, #b_0_0_0_1_1_1_0_0_0) // 3 + + + # # # + + +
    drawpoints(px, py+2, #b_0_0_0_1_1_1_0_0_0) // 2 + + + # # # + + +
    drawpoints(px, py+1, #b_0_0_0_0_1_0_0_0_0) // 1 + + + + # + + + +
    drawpoints(px, py+0, #b_0_0_0_0_1_0_0_0_0) // 0 + + + + # + + + +
    ENDCASE
  CASE 2: // Down right
    drawpoints(px, py+8, #b_0_0_0_0_0_0_0_0_0) // 8 + + + + + + + +
    drawpoints(px, py+7, #b_0_0_0_0_1_1_0_0_0) // 7 + + + + # # + + +
    drawpoints(px, py+6, #b_0_0_0_0_1_1_0_0_0) // 6 + + + + # # + + +
    drawpoints(px, py+5, #b_0_0_0_0_1_1_0_0_0) // 5 + + + + # # + + +
    drawpoints(px, py+4, #b_0_1_1_1_1_1_1_0_0) // 4 + # # # # # # + +
    drawpoints(px, py+3, #b_0_1_1_1_1_1_1_0_0) // 3 + # # # # # # + +
    drawpoints(px, py+2, #b_0_0_0_0_1_1_1_1_0) // 2 + + + + # # # # +
    drawpoints(px, py+1, #b_0_0_0_0_0_0_1_1_0) // 1 + + + + + + # # +
    drawpoints(px, py+0, #b_0_0_0_0_0_0_0_0_1) // 0 + + + + + + + #

```



```

ENDCASE
CASE 3: // Left
  drawpoints(px, py+8, #b_0_0_0_0_0_0_0_0) // 8 + + + + + + + +
  drawpoints(px, py+7, #b_0_0_0_0_0_0_0_1_0) // 7 + + + + + + # +
  drawpoints(px, py+6, #b_0_0_0_0_0_1_1_1_0) // 6 + + + + + # # # +
  drawpoints(px, py+5, #b_0_0_1_1_1_1_1_0_0) // 5 + + # # # # # + +
  drawpoints(px, py+4, #b_1_1_1_1_1_1_1_0_0_0) // 4 # # # # # # + + +
  drawpoints(px, py+3, #b_0_0_1_1_1_1_1_0_0) // 3 + + # # # # # + +
  drawpoints(px, py+2, #b_0_0_0_0_0_1_1_1_0) // 2 + + + + + # # # +
  drawpoints(px, py+1, #b_0_0_0_0_0_0_0_0_1_0) // 1 + + + + + + # +
  drawpoints(px, py+0, #b_0_0_0_0_0_0_0_0_0_0) // 0 + + + + + + + +
ENDCASE
CASE 5: // Right
  drawpoints(px, py+8, #b_0_0_0_0_0_0_0_0_0) // 8 + + + + + + + +
  drawpoints(px, py+7, #b_0_1_0_0_0_0_0_0_0) // 7 + # + + + + + +
  drawpoints(px, py+6, #b_0_1_1_1_0_0_0_0_0) // 6 + # # # + + + +
  drawpoints(px, py+5, #b_0_0_1_1_1_1_1_0_0) // 5 + + # # # # # + +
  drawpoints(px, py+4, #b_0_0_0_1_1_1_1_1_1) // 4 + + + # # # # #
  drawpoints(px, py+3, #b_0_0_1_1_1_1_1_0_0) // 3 + + # # # # # + +
  drawpoints(px, py+2, #b_0_1_1_1_0_0_0_0_0) // 2 + # # # + + + +
  drawpoints(px, py+1, #b_0_1_0_0_0_0_0_0_0) // 1 + # + + + + + +
  drawpoints(px, py+0, #b_0_0_0_0_0_0_0_0_0) // 0 + + + + + + + +
ENDCASE
CASE 6: // Up left
  drawpoints(px, py+0, #b_1_0_0_0_0_0_0_0_0) // 8 # + + + + + + +
  drawpoints(px, py+7, #b_0_1_1_0_0_0_0_0_0) // 7 + # # + + + + +
  drawpoints(px, py+6, #b_0_1_1_1_1_0_0_0_0) // 6 + # # # # + + + +
  drawpoints(px, py+5, #b_0_0_1_1_1_1_1_1_0) // 5 + + # # # # # # +
  drawpoints(px, py+4, #b_0_0_1_1_1_1_1_1_0) // 4 + + # # # # # # +
  drawpoints(px, py+3, #b_0_0_0_1_1_0_0_0_0) // 3 + + + # # + + + +
  drawpoints(px, py+2, #b_0_0_0_1_1_0_0_0_0) // 2 + + + # # + + + +
  drawpoints(px, py+1, #b_0_0_0_1_1_0_0_0_0) // 1 + + + # # + + + +
  drawpoints(px, py+0, #b_0_0_0_0_0_0_0_0_0) // 0 + + + + + + + +
ENDCASE
CASE 7: // Up
  drawpoints(px, py+8, #b_0_0_0_0_1_0_0_0_0) // 8 + + + + # + + + +
  drawpoints(px, py+7, #b_0_0_0_0_1_0_0_0_0) // 7 + + + + # + + + +
  drawpoints(px, py+6, #b_0_0_0_1_1_1_0_0_0) // 6 + + + # # # + + +
  drawpoints(px, py+5, #b_0_0_0_1_1_1_0_0_0) // 5 + + + # # # + + +
  drawpoints(px, py+4, #b_0_0_0_1_1_1_0_0_0) // 4 + + + # # # + + +
  drawpoints(px, py+3, #b_0_0_1_1_1_1_1_0_0) // 3 + + # # # # # + +
  drawpoints(px, py+2, #b_0_0_1_1_0_1_1_0_0) // 2 + + # # + # # + +
  drawpoints(px, py+1, #b_0_1_1_0_0_0_1_1_0) // 1 + # # + + + # # +
  drawpoints(px, py+0, #b_0_0_0_0_0_0_0_0_0) // 0 + + + + + + + +
ENDCASE

```

```

CASE 8: // Up right
  drawpoints(px, py+8, #b_0_0_0_0_0_0_0_0_1) // 8 + + + + + + + #
  drawpoints(px, py+7, #b_0_0_0_0_0_0_1_1_0) // 7 + + + + + # # +
  drawpoints(px, py+6, #b_0_0_0_0_1_1_1_1_0) // 6 + + + + # # # # +
  drawpoints(px, py+5, #b_0_1_1_1_1_1_1_0_0) // 5 + # # # # # # + +
  drawpoints(px, py+4, #b_0_1_1_1_1_1_1_0_0) // 4 + # # # # # # + +
  drawpoints(px, py+3, #b_0_0_0_0_1_1_0_0_0) // 3 + + + + # # + + +
  drawpoints(px, py+2, #b_0_0_0_0_1_1_0_0_0) // 2 + + + + # # + + +
  drawpoints(px, py+1, #b_0_0_0_0_1_1_0_0_0) // 1 + + + + # # + + +
  drawpoints(px, py+0, #b_0_0_0_0_0_0_0_0_0) // 0 + + + + + + + + +
  ENDCASE
}

updatescreen()
}

AND cellcolour(cell) = VALOF SWITCHON s_state!cell INTO
{ DEFAULT:          RESULTIS col_darkred

  CASE Unvisited:  RESULTIS col_gray
  CASE Closed:     RESULTIS col_lightblue
  CASE Fringe:     RESULTIS col_white
  CASE Wall:       RESULTIS col_black
  CASE Path:       RESULTIS col_lightmajenta
}

```

The following three functions implement the priority queue as needed by the A* algorithm. The queue is held in positions 1 to `priqn` of the vector `priq` where `priqn` is the current number of cells in the queue. There is the constraint that the `f` value of the cell at position i is less than or equal the `f` values of the cells at positions $2i$ and $2i + 1$, if they exist. Thus the elements of `priq` represent a perfectly balanced binary tree with the cell at position 1 having the minimum `f` value. A fringe cell's position in `priq` is always held in the `s_priqpos` field of the cell's node. The function `getleast` returns zero if the priority queue is empty, otherwise it returns the cell that was at position 1. This leaves a hole that must, if possible, be filled. This is done by taking the cell at position `priqn` provided `priqn > 1`, decrementing `priqn`, and trying to place it at position 1, but it may have to be swapped with the child with the smaller `f` value. This swapping is carried out down the tree until a valid position is reached.

```

AND getleast() = priqn=0 -> 0, VALOF
{ // Extract the cell with the least f value from
  // the priority queue. Return 0 if the queue is empty.

```

```

LET p = 1
LET mincell = priq!1 // The cell with the least f value in the queue
LET cell = priq!priqn // The last cell of priq
LET cellf = s_f!cell // Its f value

s_priqpos!mincell := 0 // Not in the priority queue anymore.

// Decrease the size of the priority queue
priqn := priqn-1

// Insert cell into the priority queue knowing that
// element at position 1 is empty

{ LET smallerchild, smallerf = ?, ?
  LET q = p+p
  // Position p in the queue is now empty

  IF q > priqn BREAK // The cell at position p has no children.

  // There is at least one child
  smallerchild := priq!q // The first child cell
  smallerf := s_f!smallerchild

  IF q < priqn DO
  { // There is a second child
    LET child2 = priq!(q+1)
    LET child2f = s_f!child2
    IF child2f < smallerf DO
    { // The second child has a smaller f value
      q := q+1
      smallerf := child2f
    }
  }
}

// If the f value of cell is no larger than that of the smaller
// child, break out of the loop.

IF cellf <= smallerf BREAK

// Move the smaller child one level towards the root, and
// set p to the position of the new hole.

priq!p := smallerchild
s_priqpos!smallerchild := p
p := q // p is now the position where the smaller child was.

```

```

} REPEAT

priq!p := cell
s_priqpos!cell := p
//chkpriq()           // A debugging aid

RESULTIS mincell
}

```

The function `insert` inserts a cell into the priority queue. It does this by incrementing `priqn` and calling `positioncell` to attempt to place the cell at this position, but `positioncell` may well have to move the cell toward the root before a valid position is found.

```

AND insert(cell) BE
{ // Insert cell into the priority queue.

  // Increase the size of the priority queue.
  priqn := priqn+1
  IF priqn > priqpb DO
  { writef("Need a larger priority queue, priqn=%n priqpb=%n*n",
          priqn, priqpb)
    abort(999)
  }

  IF priqnmax < priqn DO priqnmax := priqn

  positioncell(cell, priqn)
}

```

The function `positioncell` repositions a cell in the priority queue when its `f` value has just changed. The current position is given as the argument `p`. The function just moves the cell towards the root until it reaches a valid position.

```

AND positioncell(cell, p) BE
{ // Position p in the priority queue is empty. Insert cell
  // at the appropriate position between p and the root.
  LET f = s_f!cell

  WHILE p > 1 DO
  { // p is the position of an empty element in the queue
    LET q = p/2           // q is the position of its parent

```

```

    LET parent = priq!q // This is the parent cell
    // Break out of the loop if the f value of the parent is no
    // larger than that of cell.
    IF s_f!parent <= f BREAK
    priq!p := parent // Move the parent one level further from the root
    s_priqpos!parent := p
    p := q
}

priq!p := cell // Insert cell in its new position
s_priqpos!cell := p // Set its new position in the cell node.
}

```

The following function is a debugging aid to check that the priority queue structure is valid. It is called when tracing is turned on every time the priority queue is modified.

```

AND chkpriq() BE
{ FOR i = 1 TO priqn DO
  { LET parent = priq!i
    LET f = s_f!parent
    LET priqpos = s_priqpos!parent
    LET q = i+i // The position of the first child if it exists.

    // Check the cell's state and priqpos value.
    UNLESS s_state!parent=Fringe & priqpos = i DO
    { writef("Error at %i3: priqpos=%n in cell ", i, s_priqpos!parent)
      prcell(parent)
      prpriq(1, 0, 0)
      abort(999)
    }

    IF q<=priqn DO
    { LET childf = s_f!(priq!q)
      UNLESS f <= childf DO
      { writef("Parent at position %n and child at %n have f values %n and %n*n",
        i, q, f, childf)
        prpriq(1, 0, 0)
        abort(999)
      }
    }
  }
}

IF q+1<=priqn DO
{ LET childf = s_f!(priq!(q+1))
  UNLESS f <= childf DO

```

```

    { writef("Parent at position %n and child at %n have f values %n and %n*n",
            i, q+1, f, childf)
      prpriq(1, 0, 0)
      abort(999)
    }
  }
}
}
}

```

The functions `prpriq` and `prindent` provide a debugging aid to print out the priority queue, showing its structure. It is invoked when tracing is turned on every time the priority queue changes. Typical output is as follows.

```

New fringe cell created [1 ( 15, 24) ( 15, 23) 24+438=462]
456          at (16,22) p=1
*--456       at (16,23) p=2
| *--464     at (16,21) p=4
| | *--484   at (13,21) p=8
| | *--470   at (14,21) p=9
| *--462     at (15,24) p=5
| *--476     at (14,24) p=10
| *--476     at (13,22) p=11
*--462       at (14,23) p=3
  *--476     at (13,23) p=6
  *--464     at (15,21) p=7

!! ABORT 1000: Unknown fault
*

```

It leaves the program in the interactive debugger. Normal execution can be resumed by typing `c`. The definitions of `prpriq` and `prindent` are as follows.

```

AND prpriq(p, depth, indentbits) BE IF p<=priqn DO
{ // This function outputs the priority queue.
  // The output includes an indication of the binary heap
  // structure to assist debugging of the priority queue code.
  // If tracing is TRUE, prpriq(1, 0, 0) is called every
  // time the priority queue is modified.
  LET cell = priq!p
  LET f = s_f!cell
  LET pos = s_pos!cell
  LET x, y = xcoord(pos), ycoord(pos)

```

```

LET q = p+p          // The position of the first child, if any.
writef("%n          at (%n,%n) p=%n*n", f, x, y, p)

IF q<=priqn DO      // Output the first child tree
{ prindent(depth, indentbits)
  writef("**--")
  prpriq(q, depth+1, indentbits<<1 | 1)
}

IF q+1<=priqn DO   // Output the second child tree
{ prindent(depth, indentbits)
  writef("**--")
  prpriq(q+1, depth+1, indentbits<<1)
}
}

AND prindent(depth, bits) BE IF depth>0 DO
{ prindent(depth-1, bits>>1)
  writes((bits&1)=0 -> "  ", "| ")
}
}

```

The remaining two functions provide the heuristic for both the A* algorithm and Dijkstra's algorithm. The appropriate one is assigned to `heuristic` at the start of the run.

```

AND astar_heuristic(cell1, cell2) = VALOF
{ LET pos1 = s_pos!cell1
  LET pos2 = s_pos!cell2
  LET dx = ABS(pos1 MOD xsize - pos2 MOD xsize)
  LET dy = ABS(pos1 / xsize - pos2 / xsize)

  // Assuming dx>=0 and dy>=0 and dx>dy, return the cost of a path
  // consisting of (dx-dy) steps in the x direction followed by dy
  // steps diagonally towards the goal, giving a cost of
  // 10*(dx-dy)+14*dy = 10*dx+4*dy
  // The calculation is similar for other directions.
  IF dx>=dy RESULTIS 10*dx + 4*dy
  RESULTIS 10*dy + 4*dx
}

AND dijkstra_heuristic(cell1, cell2) = 0

```

5.15 Robots

This section describes a program that displays some robots that are designed to work cooperatively collecting randomly placed bottles with their grabbers and depositing them in a pit. The dark green robot can be controlled by the user using the arrow keys, **G** for grab and **R** for release. The robots and bottles move and bounce off each other and the walls. Bottles over the pit disappear. The bottles slide over the ground without friction, but the pit is at the top of a gentle conical hill that repels bottles that get too close. As a debugging aid properties of the dark green robot and the black coloured bottle can be displayed on the screen by pressing **D**. At the moment, the dark green robot can be controlled by hand to grab bottles and deposit them into the pit. If two robots find that they are on a collision path they both make minor adjustments to hopefully avoid each other. A typical image is the following.

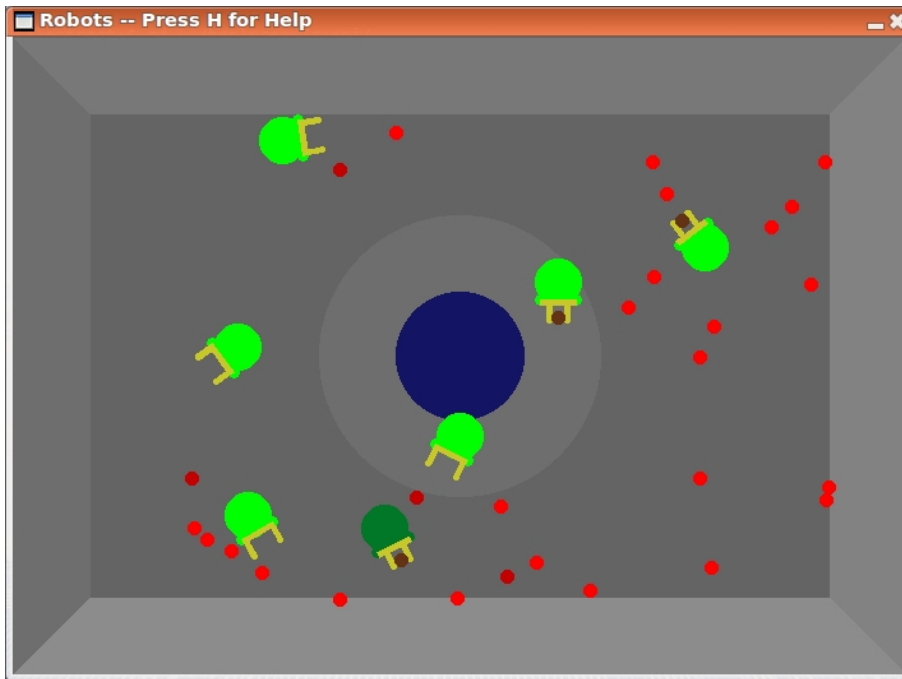

The program is called `raspi/robots.b` and is currently as follows.

```
/*
```

```
This is a program that displays some robots attempting to
pick up bottles with their grabbers and deposit them in a pit.
```

```
Implemented by Martin Richards (c) February 2015
```

History:

08/12/2016

Trying a new algorithm for robot-robot collision avoidance.

27/11/2016

Currently teaching the robots to catch and dispose of the bottles.

02/02/2015

Initial implementation started based on bucket.b.

*/

SECTION "sdllib"

GET "libhdr"

GET "sdl.h"

GET "sdl.b" // Insert the library source code

.

SECTION "robots"

GET "libhdr"

GET "sdl.h"

MANIFEST {

// Most arithmetic uses scaled numbers with 3 digits
// after the decimal point.

One = 1_000 // The constant 1.000 scaled with 3 decimal
// digits after the decimal point.

OneK = 1000 * One

spacevupb = 100000

pitradius = 50_000

bottleradius = 5_000

robotradius = 18_000

shoulderradius = 4_000

tipradius = 2_000 // Tip of grabber arm

armthickness = 2*tipradius

grablen = 12_000

edgesize = 60_000

grabbedpos = bottleradius / // (Typically = 0_500)
((robotradius - shoulderradius - 2*tipradius)/One)

//##### Robot geometry #####

```

//
//
//          Y
//          ^          shoulder
//          |          /
//          + + + + +   + + + /          tip
//          +          |   + | +          /
//          +          |   + + o----a + + + + + d /          ----- y = r1-r2
//          +          |   + ++ ++          p +          |d1 = 2 x r3
//          +          r1   + + ++ b + + + + + c          ----- y = r1-r2-d1
//          + left      |   + ++          ^
//          +          |   + +          d2 = (r1-r2-d1) x grabpos/0ne
//          +          |   + +          v          0.1<=grabpos<=1.0
//          +-----r1-----0-----+-----q-----> X
//          +          |   + +          q = (r1+2xr4,0) centre of grabbed bottle
//          +          |   + +
//          + right    |   + ++          r1 = robotradius      = 18.0
//          +          |   + + ++ b + + + + + c          r2 = shoulderradius = 4.0
//          +          |   + ++ ++          p +          r3 = tipradius      = 2.0
//          +          |   + + o----a + + + + + d          r4 = bottleradius   = 5.0
//          +          |   + | +
//          +          + + + + +   + + + |<---d3---->|          d3 = grablen      = 12.0

// Bottle field selectors
b_cgx=0; b_cgy          // The first four must be in positions 0 to 4
b_cgxdot; b_cgydot
b_grabbed // If grabbed, b_robot is the grabbing robot
b_robot // 0 or the robot that selected this bottle
b_dropped // If true, the bottle has fallen into the pit
b_id // The bottle number

b_upb=b_id
b_size // Number of elements in a bottle node

// robot selectors
r_cgx=0; r_cgy // The first four must be in positions 0 to 3
r_cgxdot; r_cgydot
r_grabpos; r_grabposdot
r_bottle // =0 or the selected bottle
r_inarea // =TRUE if the bottle in the grabber area
// and the grabber is closing
// if another bottle is found to be in the
// grabber area, the grabber opens and if the
// selected bottle was grabbed it is released.

// Coordinates of the robot shoulders

```

```

r_lex; r_ley; r_rex; r_rey // le re
r_lcx; r_lcy; r_rcx; r_rcy // lc rc

// Coords of the robot arms
r_ltax; r_ltay; r_rtax; r_rtay // ltd ltp ltc rtc rtp rtd
r_ltbx; r_ltby; r_rtbx; r_rtby //
r_ltcx; r_ltcy; r_rtcx; r_rtcy //
r_ltdx; r_ltdy; r_rtdx; r_rtdy //
r_ltpx; r_ltpy; r_rtpx; r_rtpy // lta ltb rtb rta

r_bcx; r_bcy // Centre of the grabber.

r_id // The robot number

r_upb=r_id
r_size // Number of elements in a robot node
}

GLOBAL {
done:ug
debugging
help // Display help information
stepping // =FALSE if not stepping
finished

usage
displayusage
debugging

sps // Steps per second, adjusted automatically

bottles // Number of bottles
bottlev // Vector of bottles
// bottlev!0 holds the current number of bottles
robots // Number of robots
robotv // Vector of robots
// robotv!0 holds the current number of robots

// coords of the pit centre
pit_x; pit_y; pit_xdot; pit_ydot
thepit // -> [ pitx, pity, pit_xdot, pit_ydot]
xsize // Window size in pixels
ysize
seed

```

```

spacev; spacep; spacet
mkvec

bottlecount    // Number of bottles not yet in the pit
freebottles    // Number of free bottles -- not selected or dropped

bottlesurfR    // Surface for a red bottle
bottlesurfDR   // Surface for a dark red selected bottle
bottlesurfK    // Surface for a black bottle (number 1)
bottlesurfB    // Surface for a brown bottle (grabbed)
pitsurf        // Surface for the bucket base

backcolour     // Background colour
col_red; col_black; col_brown
col_darkred; col_darkblue; col_darkgreen
col_gray1; col_gray2; col_gray3; col_gray4

pitcolour
robotcolour
roboticcolour
grabbercolour

wall_wx        // West wall x coordinate
wall_ex        // East wall x coordinate
wall_sy        // South wall y coordinate
wall_ny        // North wall y coordinate

priq           // Heap structure for the time queue
priqn          // Number of items in priq
priqubp       // Upb of priq

msecsnow      // Updated by step, possibly releasing
              // events in the priority queue
msecs0        // Starting time since midnight
}

LET mkvec(upb) = VALOF
{ LET p = spacep
  spacep := spacep+upb+1
  IF spacep>spacet DO
  { writef("Insufficient space*n")
    abort(999)
    RESULTIS 0
  }
}
//writef("mkvec(%n) => %n*n", upb, p)

```

```

    RESULTIS p
  }

  AND mk2(a, b) = VALOF
  { LET p = mkvec(1)
    p!0, p!1 := a, b
    RESULTIS p
  }

  AND incontact(p1, p2, dist) = VALOF
  { // This returns TRUE if points p1 and p2 are no more than dist apart.
    LET dx = ABS(p1!0-p2!0)
    LET dy = ABS(p1!1-p2!1)

    //writef("incontact: x1=%9.3d y1=%9.3d*n", p1!0, p1!1)
    //writef("incontact: x2=%9.3d y2=%9.3d*n", p2!0, p2!1)
    //writef("incontact: dx=%9.3d dy=%9.3d dist=%9.3d*n", dx, dy, dist)
    IF dx > dist | dy > dist DO
    { //writef("=> FALSE*n");
      //abort(9104)
      RESULTIS FALSE
    }
    //writef("dx^2   =%12.3d*n", muldiv(dx,dx,One))
    //writef("dy^2   =%12.3d*n", muldiv(dy,dy,One))
    //writef("dist^2 =%12.3d*n", muldiv(dist,dist,One))
    //abort(9102)
    IF muldiv(dx,dx,One) + muldiv(dy,dy,One) >
      muldiv(dist,dist,One) DO
    { //writef("=> FALSE*n")
      //abort(9105)
      RESULTIS FALSE
    }
    //writef("=> TRUE*n")
    //abort(9103)
    RESULTIS TRUE
  }

  AND cbounce(p1, p2, m1, m2) BE
  { // p1!0 and p1!1 are the x and y coordinates of a circular object.
    // p1!2 and p1!3 are the corresponding velocities
    // p1!4 and p1!5 are the corresponding direction cosines
    // p2!0 and p2!1 are the x and y coordinates of the other circular object.
    // p2!2 and p2!3 are the corresponding velocities
    // p2!4 and p2!5 are the corresponding direction cosines
    // m1 and m2 are the masses of the two objects in arbitrary units

```

```

// m1=m2 if the collision is between two bottles or two robots.
// m1=5 and m2=1 then p1 is a robot and p2 is a bottle.
// m1=1 and m2=0 then p1 is an infinitely heavy robot or grabbed bottle
//
//           and p2 is a bottle.

LET c = cosines(p2!0-p1!0, p2!1-p1!1) // Direction from p1 to p2
LET s = result2

IF m2=0 DO
{ // Object 1 is a robot or a grabbed bottle and object 2 is a bottle.
  // The robots or grabbed bottle is treated as infinitely heavy.
  LET xdot = p2!2 - p1!r_cgxdot
  LET ydot = p2!3 - p1!r_cgydot
  // Transform to (t,w) coordinates
  // where t is in the direction from the robot to the bottle
  LET tdot = inprod(xdot,ydot, c, s)
  LET wdot = inprod(xdot,ydot, -s, c)

//writef("robot-bottle bounce tdot=%9.3d wdot=%9.3d*n", tdot, wdot)
  IF tdot>0 RETURN // The robot and bottle are moving apart

  // The bottle is getting closer so reverse tdot (but not wdot)
  // and transform back to world (x,y) coordinates.
  tdot := rebound(tdot) // Reverse tdot with some loss of energy
  // Transform back to real world (x,y) coordinates
  p2!2 := inprod(tdot, wdot, c, -s) + p1!r_cgxdot
  p2!3 := inprod(tdot, wdot, s, c) + p1!r_cgydot
  // Note that the robot or grabbed bottle motion is not changed.
  RETURN
}

IF m1=m2 DO
{ // This deals with bottle-bottle and robot-robot bounces.
  // Find the velocity of the centre of gravity
  LET cgxdot = (p1!2+p2!2)/2
  LET cgydot = (p1!3+p2!3)/2
  // Calculate the velocity of object 1
  // relative to the centre of gravity
  LET rx1dot = p1!2 - cgxdot
  LET ry1dot = p1!3 - cgydot
  // Transform to (t,w) coordinates
  LET t1dot = inprod(rx1dot,ry1dot, c,s)
  LET w1dot = inprod(rx1dot,ry1dot, -s,c)

  IF t1dot<=0 RETURN // The objects are moving apart

```

```

// Reverse t1dot with some loss of energy
t1dot := rebound(t1dot)

// Transform back to (x,y) coordinates relative to cg
rx1dot := inprod(t1dot,w1dot, c,-s)
ry1dot := inprod(t1dot,w1dot, s, c)

// Convert to world (x,y) coordinates
p1!2 := rx1dot + cgxdot
p1!3 := ry1dot + cgydot

p2!2 := -rx1dot + cgxdot
p2!3 := -ry1dot + cgydot

// Apply a small repulsive force between the objects.

p1!0 := p1!0 - muldiv(0_400, c, One)
p1!1 := p1!1 - muldiv(0_400, s, One)
p2!0 := p2!0 + muldiv(0_400, c, One)
p2!1 := p2!1 + muldiv(0_400, s, One)

RETURN
}

{ // m1~m2 and neither are zero.
  // Object 1 is a robot and object 2 is a bottle
  // and the robot is not infinitely heavy.
  // Find the velocity of the centre of gravity
  LET cgxdot = (p1!2*m1+p2!2*m2)/(m1+m2)
  LET cgydot = (p1!3*m1+p2!3*m2)/(m1+m2)
  // Calculate the velocities of the two objects
  // relative to the centre of gravity
  LET rx1dot = p1!2 - cgxdot
  LET ry1dot = p1!3 - cgydot
  LET rx2dot = p2!2 - cgxdot
  LET ry2dot = p2!3 - cgydot
  // Transform to (t,w) coordinates
  LET t1dot = inprod(rx1dot,ry1dot, c,s)
  LET w1dot = inprod(rx1dot,ry1dot, -s,c)
  LET t2dot = inprod(rx2dot,ry2dot, c,s)
  LET w2dot = inprod(rx2dot,ry2dot, -s,c)

IF FALSE DO
{

```

```

writef("dir  =(%10.3d,%10.3d)*n", c, s)
writef("p1   =(%10.3d,%10.3d)*n", p1!0, p1!1)
writef("p2   =(%10.3d,%10.3d)*n", p2!0, p2!1)
writef("p1dot=(%10.3d,%10.3d) m1=%n*n", p1!2, p1!3, m1)
writef("p2dot=(%10.3d,%10.3d) m2=%n*n", p2!2, p2!3, m2)
writef("cgdot=(%10.3d,%10.3d)*n", cgxdot, cgydot)
writef("r1dot=(%10.3d,%10.3d)*n", rx1dot, ry1dot)
writef("r2dot=(%10.3d,%10.3d)*n", rx2dot, ry2dot)
writef("t1dot=(%10.3d,%10.3d)*n", t1dot, w1dot)
writef("t2dot=(%10.3d,%10.3d)*n", t2dot, w2dot)
writef("t1dot=%10.3d is the speed towards the centre of gravity*n", t1dot)
abort(1000)
}
  IF t1dot<=0 RETURN // The robot and bottle are moving apart

  // Reverse t1dot and t2dot with some loss of energy
  t1dot := rebound(t1dot)
  t2dot := rebound(t2dot)

  // Transform back to (x,y) coordinates relative to cg
  rx1dot := inprod(t1dot,w1dot, c,-s)
  ry1dot := inprod(t1dot,w1dot, s, c)
  rx2dot := inprod(t2dot,w2dot, c,-s)
  ry2dot := inprod(t2dot,w2dot, s, c)

  // Convert to world (x,y) coordinates
  p1!2 := rx1dot + cgxdot
  p1!3 := ry1dot + cgydot

  p2!2 := rx2dot + cgxdot
  p2!3 := ry2dot + cgydot
}
}

```

```

AND rebound(vel) = vel/8 - vel // Returns the rebound speed of a bounce

```

```

AND cosines(x, y) = VALOF

```

```

{ // This function returns the cosine and sine of the angle between
  // the line from (0,0) to (x, y) and the x axis.
  // The result is the cosine and result2 is the sine.
  LET c, s, a = ?, ?, ?
  LET d = ABS x + ABS y
  UNLESS d DO
  { result2 := 0
    RESULTIS One
  }
}

```



```

}
c := muldiv(x, One, d) // Approximate cos and sin
s := muldiv(y, One, d) // Direction good, length not.
a := muldiv(c,c,One)+muldiv(s,s,One) // 0.5 <= a <= 1.0
d := 1_000 // With this initial guess only 3 iterations
           // of Newton-Raphson are required.
//writef("a=%8.3d d=%8.3d d^2=%8.3d*n", a, d, muldiv(d,d,One))
d := (d + muldiv(a, One, d))/2
//writef("a=%8.3d d=%8.3d d^2=%8.3d*n", a, d, muldiv(d,d,One))
d := (d + muldiv(a, One, d))/2
//writef("a=%8.3d d=%8.3d d^2=%8.3d*n", a, d, muldiv(d,d,One))
d := (d + muldiv(a, One, d))/2
//writef("a=%8.3d d=%8.3d d^2=%8.3d*n", a, d, muldiv(d,d,One))

s := muldiv(s, One, d) // Corrected cos and sin
c := muldiv(c, One, d)
//writef("x=%8.3d y=%8.3d => cos=%8.3d sin=%8.3d*n", x, y, c, s)
//abort(3589)
result2 := s
RESULTIS c
}

AND inprod(dx, dy, c, s) = muldiv(dx, c, One) + muldiv(dy, s, One)

LET step() BE
{ // This function deals with the motion of all the robots and bottles
  // and their interactions with each other and the wall and the pit.

  msecsnow := sdlmsecs() - msecso
  // Deal with crossing midnight assuming now is no more than
  // 24 hours since the start of the run.
  IF msecsnow<0 DO msecsnow := msecsnow + (24*60*60*1000)

  //writef("step: entered*n")
  //IF bottlecount=0 DO finished := TRUE

  // Robots always point in their directions of motion given by
  // cgxdot and cgydot. A robot with a selected bottle will rotate
  // towards its bottle and be given sufficient speed it to catch
  // it up. Interaction between robots and the walls, the pit,
  // and other robots affect cgxdot and cgydot.

  //abort(9001)

  // (1) Deal with robot bounces and collisions with the walls and

```

```

//      pit slope.

FOR rib = 1 TO robotv!0 DO
{ LET r = robotv!rib
  LET x, y = r!r_cgx, r!r_cgy

  LET dw = x - wall_wx // Distance from west wall
  AND dn = wall_ny - y // Distance from north wall
  AND de = wall_ex - x // Distance from east wall
  AND ds = y - wall_sy // Distance from south wall

  // Limit the speed of the robot

  IF ABS r!r_cgxdot > 40_000 | ABS r!r_cgydot > 40_000 DO
    r!r_cgxdot, r!r_cgydot := r!r_cgxdot*97/100, r!r_cgydot*97/100

  // Ensure the robot is always moving.

  WHILE ABS r!r_cgxdot + ABS r!r_cgydot < 1_000 DO
  { //sawritef("R%i2: Random nudge: xdot=%8.3d ydot=%8.3d*n",
    //          r!r_id, r!r_cgxdot, r!r_cgydot)
    r!r_cgxdot := r!r_cgxdot + randno(201) - 100
    r!r_cgydot := r!r_cgydot + randno(201) - 100
  }

  // Test if the robot is closest to the west wall
  IF dw<edgesize & dw<=dn & dw<=ds DO
  { // (x,y) is closest to the west wall
    TEST dw < robotradius
    THEN r!r_cgxdot, r!r_cgx := -r!r_cgxdot, wall_wx + robotradius
    ELSE r!r_cgxdot := r!r_cgxdot + 4_000
  }

  // Test if the robot is closest to the north wall
  IF dn<edgesize & dn<=de & dn<=dw DO
  { // (x,y) is closest to the north wall
    TEST dn < robotradius
    THEN r!r_cgydot, r!r_cgy := -r!r_cgydot, wall_ny - robotradius
    ELSE r!r_cgydot := r!r_cgydot - 4_000
  }

  // Test if the robot is closest to the east wall
  IF de<edgesize & de<=ds & de<=dn DO
  { // (x,y) is closest to the east wall
    TEST de < robotradius

```

```

    THEN r!r_cgxdot, r!r_cgxdot := -r!r_cgxdot, wall_ex - robotradius
    ELSE r!r_cgxdot := r!r_cgxdot - 4_000
  }

  // Test if the robot is closest to the south wall
  IF ds<edgesize & ds<=de & ds<=dw DO
  { // (x,y) is closest to the south wall
    TEST ds < robotradius
    THEN r!r_cgydot, r!r_cgydot := -r!r_cgydot, wall_sy + robotradius
    ELSE r!r_cgydot := r!r_cgydot + 4_000
  }

  IF incontact(r, thepit, pitradius+edgesize) DO
  { // If the robot is on the pit slope.
    LET c = cosines(x-pit_x, y-pit_y)
    LET s = result2
    r!r_cgxdot := r!r_cgxdot + inprod(1_000,0, c,-s)
    r!r_cgydot := r!r_cgydot + inprod(1_000,0, s, c)
  }
}

// (2) Deal with bottle bounces and collisions with the walls,
//     pit slope. Drop bottles that are above the pit and
//     decrement bottlecount and freebottles appropriately.
//     If the bottle was owned start opening its start
//     opening owner's grabber, if not fully open.

FOR bid = 1 TO bottlev!0 DO
{ LET b = bottlev!bid

  IF b!b_dropped LOOP

  // Limit the speed of the bottle

  IF ABS b!b_cgxdot > 35_000 | ABS b!b_cgydot > 35_000 DO
    b!b_cgxdot, b!b_cgydot := b!b_cgxdot*97/100, b!b_cgydot*97/100

  // Test if the bottle is within the pit slope circle.

  IF incontact(b, thepit, pitradius+edgesize) DO
  { // The bottle is within the pit slope circle.

    IF incontact(b, thepit, pitradius-bottleradius) DO
    { // The bottle is actually above the pit so must be dropped.

```

```

// Note that freebottles is the count of how many bottles are
// neither selected nor dropped.
// bottlecount is the number of bottles that have not yet dropped.

LET owner = b!b_robot // Find the owner, if any.

IF owner DO
{ owner!r_bottle := 0           // Deselect the bottle.
  owner!r_inarea := FALSE      // Only TRUE if the selected bottle
                               // is in the area.
  UNLESS owner!r_grabpos= 1_000 DO // Start opening the owner's
    owner!r_grabposdot := +0_600 // grabber if necessary.
    b!b_grabbed := FALSE        // Ensure the bottle is not grabbed.
    b!b_robot := 0             // The bottle has no owner.
    freebottles := freebottles + 1 // The bottle is no longer owned.
}

// The bottle had no owner and is being dropped into the pit
// so decrement freebottles and bottlecount
freebottles := freebottles - 1
bottlecount := bottlecount - 1
b!b_dropped := TRUE

LOOP // This bottle has gone, so consider another bottle, if any.
}

// The bottle is not above the pit but is on the pit slope.

{ // Deal with bottle-pit slope interactions
  // Calculate the direction from the pit centre to the bottle.
  LET dx = cosines(b!b_cgxp-pit_x, b!b_cgy-pit_y)
  LET dy = result2
  //writef("B%i2: dx=%10.3d dy=%10.3d dx=%10.3d dy=%10.3d*n",
  //      bid, b!b_cgxp-pit_x, b!b_cgy-pit_y, dx, dy)

  // Apply a constant force away from the pit centre.
  b!b_cgxdot := b!b_cgxdot + muldiv(10_000, dx, One)
  b!b_cgydot := b!b_cgydot + muldiv(10_000, dy, One)
}

// This bottle is within the pit slope circle so cannot be
// on a wall edge.
LOOP
}

```

```

// This bottle may be near a wall edge.

{ LET x = b!b_cgx
  LET y = b!b_cgy

  // Bottle interaction with the walls
  LET dw = x - wall_wx // Distance from west wall
  AND dn = wall_ny - y // Distance from north wall
  AND de = wall_ex - x // Distance from east wall
  AND ds = y - wall_sy // Distance from south wall

  // Test if the bottle closest to the west wall.
  IF dw < edgsize & dw<=dn & dw<=ds DO
  { // (x,y) is closest to the west wall
    TEST dw < bottleradius
    THEN b!b_cgxdot, b!b_cgx := -b!b_cgxdot, wall_wx + bottleradius
    ELSE b!b_cgxdot := b!b_cgxdot + 20_000
  }

  // Test if the bottle closest to the north wall.
  IF dn < edgsize & dn<=de & dn<=dw DO
  { // (x,y) is closest to the north wall
    TEST dn < bottleradius
    THEN b!b_cgydot, b!b_cgy := -b!b_cgydot, wall_ny - bottleradius
    ELSE b!b_cgydot := b!b_cgydot - 20_000
  }

  // Test if the bottle closest to the east wall.
  IF de < edgsize & de<=ds & de<=dn DO
  { // (x,y) is closest to the east wall
    TEST de < bottleradius
    THEN b!b_cgxdot, b!b_cgx := -b!b_cgxdot, wall_ex - bottleradius
    ELSE b!b_cgxdot := b!b_cgxdot - 20_000
  }

  // Test if the bottle closest to the south wall.
  IF ds < edgsize & ds<=de & ds<=dw DO
  { // (x,y) is closest to the south wall
    TEST ds < bottleradius
    THEN b!b_cgydot, b!b_cgy := -b!b_cgydot, wall_sy + bottleradius
    ELSE b!b_cgydot := b!b_cgydot + 20_000
  }
}
// Consider another bottle, if any.
}

```

```

// (3) Deal with robot-robot bounces and collision avoidance.

FOR rid1 = 1 TO robotv!0 DO
{ // Test for robot-robot interaction -- collision avoidance and bouncing.
  LET r1 = robotv!rid1
  LET x1, y1 = r1!r_cgx, r1!r_cgy

  FOR rid2 = rid1+1 TO robotv!0 DO
  { LET r2 = robotv!rid2 // Another robot
    LET x2, y2 = r2!r_cgx, r2!r_cgy

    IF incontact(r1, r2, 12*robotradius) DO
    { // These two robots are close enough for collision avoidance
      // to be applied, or possibly perform a simple bounce.
      //sawritef("R%i2 is in avoidance range with R%i2*n", rid1, rid2)

      // But if they are touching perform a simple bounce.
      TEST incontact(r1, r2, 2*robotradius)
      THEN { // The robots are in contact so perform a simple bounce.
        //sawritef("R%i2 is bouncing off R%i2*n", rid1, rid2)
        cbounce(r1, r2, 1, 1)
        // cbounce does not move the robots
      }
    }
  }
}
//abort(9109)
}
ELSE { // The robots are in range and not touching
  // so perform collision avoidance adjustment,
  // if necessary.

  LET dx = x2-x1 // Position of r2 relative to r1
  LET dy = y2-y1

  // Subtract the velocity of r2 from both r1 and r2
  // effectively make r2 stationary.
  LET relvx = r1!r_cgxdot - r2!r_cgxdot
  LET relvy = r1!r_cgydot - r2!r_cgydot

  // Compute the direction cosines of the relative velocity
  LET c = cosines(relvx, relvy)
  LET s = result2

  // Rotate about r to make the relative velocity lie in
  // the X axis, and calculate where this will leave r2.
  LET sepx = muldiv(c, dx, One) + muldiv(s, dy, One)
  AND sepy = muldiv(c, dy, One) - muldiv(s, dx, One)
}
}

```

```

// sepx is the distance to travel before reaching the closest
//      approach
// sepy is the closest approach distance.

IF rid1=-1 DO
{ writef("R%n: is avoidance range with R%n*n", rid1, rid2)
  writef("R%n:  cg (%8.3d,%8.3d)      velocity = (%8.3d,%8.3d)*n",
          rid1, x1, y1,  r1!r_cgxdot, r1!r_cgydot)
  writef("R%n:  cg (%8.3d,%8.3d)      velocity = (%8.3d,%8.3d)*n",
          rid2, x2, y2,  r2!r_cgxdot, r2!r_cgydot)
  writef("(dx,dy)=(%8.3d,%8.3d) Rel velocity = (%8.3d,%8.3d)*n",
          dx, dy, relvx, relvy)
  writef("Rel velocity direction cosines      (%8.3d,%8.3d)*n",c,s)
  writef("sepx = %8.3d  sepy = %8.3d minsep = %8.3d*n",
          sepx, sepy, 6*robotradius)

  abort(9100)
}

IF rid1=-1 & sepx>0 DO
  writef("R%i2 and R%i2: ABS sepy = %9.3d  6**robotradius=%9.3d*n",
          rid1, rid2, ABS sepy, 6*robotradius)

IF sepx>0 & ABS sepy < 6*robotradius DO
{ // The robots are getting closer and will get too close
  // so an adjustment must be made
  // The forces depend on the robot's speed
  LET f1 = (ABS r1!r_cgxdot + ABS r1!r_cgydot)*12/100
  LET f2 = (ABS r2!r_cgxdot + ABS r2!r_cgydot)*12/100

  LET fx1 = +muldiv(f1, s, One)
  AND fy1 = -muldiv(f1, c, One)
  LET fx2 = +muldiv(f2, s, One)
  AND fy2 = -muldiv(f2, c, One)

  IF sepy<0 DO
  { fx1, fy1 := -fx1, -fy1 // Apply forces in the right direction
    fx2, fy2 := -fx2, -fy2
  }
  // Apply force (fx1,fy1) to robot r1. Note that the direction of
  // (fx1,fy1) is (-s,c)
  // Robot r2 receives its force in the opposite direction.

  r1!r_cgxdot, r1!r_cgydot := r1!r_cgxdot+fx1, r1!r_cgydot+fy1

```

```

        r2!r_cgxdot, r2!r_cgydot := r2!r_cgxdot-fx2, r2!r_cgydot-fy2

        // This changes the velocities of both robots but not their
        // positions.

        IF rid1=-1 DO
        { //writef("R%i2 and %i2: ABS sepy = %9.3d 6**robotradius=%9.3d*n",
          //      rid1, rid2, ABS sepy, 6*robotradius)
          writef("Applying fx1=%9.3d fy1=%9.3d to R%n*n", fx1, fy1, rid1)
          writef("Applying fx2=%9.3d fy2=%9.3d to R%n*n", fx2, fy2, rid2)
          //abort(631)
        }

        // Do not move the robots yet.
    }
}
}
}

// (4) For each robot, set inarea=false then look at every bottle.
// Deal with its bounces off the robot body, shoulders,
// and grabber.
// If a bottle is in the grabber area and the grabber is fully
// open and inarea=false, cause it to become the robot's selected
// bottle, set inarea=true and start closing the grabber, but if
// inarea was true there are two or more bottles in the grabber
// area so start opening the grabber to let one or more escape.
// If inarea=true and grabposdot<0 and grappos<=grabbedpos set
// grabbed to true and set grabposdot=0.

FOR rid = 1 TO robotv!0 DO
{ LET r = robotv!rid
  LET b = r!r_bottle // The currently selected bottle
  LET inareacount = 0 // Count of the number of bottle in the grabber area
                      // If >0 b will be a bottle in the grabber area

  UNLESS b IF freebottles & r!r_grabpos=1_000 DO
  { // This robot can select a bottle
//sawritef("R%n: has no selected bottle, freebottles=%n and grabpos=%6.3*n",
//      rid, freebottles, r!r_grabpos)

    FOR bid = 1 TO bottlev!0 DO

```



```

    { b := bottlev!bid

      UNLESS b!b_dropped | b!b_robot DO
      { // Bottle b is neither dropped nor owned by another
        // robot, so select it.
        r!r_bottle := b
        r!r_inarea := FALSE // This should not be necessary.
        b!b_robot := r
        freebottles := freebottles - 1
//sawritef("R%n: selects B%n, freebottles=%n*n", rid, bid, freebottles)
        BREAK
      }
    }
  }

  // This robot has a selected if one was available.

  // Now deal with robot-bottle interaction.
  // This requires the robots coordinates to be calculated.
  robotcoords(r)

  FOR bid = 1 TO bottlev!0 DO
  { LET b = bottlev!bid

    IF b!b_dropped LOOP // Ignore dropped bottles

      // Ignore this bottle unless it is close to the robot.
      UNLESS incontact(r, b, 3*robotradius) LOOP

      IF rid=-1 DO
      { writef("R%n is close to B%n*n", rid, bid)
        abort(3002)
      }

      // Test if the bottle has hit the body of the robot.
      IF incontact(r, b, robotradius+bottleradius) DO
      { // If so make the bottle bounce off.
        IF rid=-1 DO
          writef("R%n body bounce with B%n*n", rid, bid)
          cbounce(r, b, 1, 0) // The robot is infinitely heavy
        }

        // Test for left shoulder-bottle bounce
        { LET sx, sy, sxdot, sydot =
          r!r_lcx, r!r_lcy, // Left shoulder centre

```

```

        r!r_cgxdot, r!r_cgydot    // Motion ignoring rate of rotation.
LET s = @sx                      // Centre of left choulder.
IF incontact(s, b, shoulderradius+bottleradius) DO
{ // They are in contact so make the bottle bounce off
  IF rid=-1 DO
    writef("R%n left shoulder contact with B%n*n", rid, bid)
    cbounce(s, b, 1, 0) // Robot is inifinitely heavy
  }
}

// Test for right shoulder-bottle bounce
{ LET sx, sy, sxdot, sydot =
  r!r_rcx, r!r_rcy,
  r!r_cgxdot, r!r_cgydot
LET s = @sx
IF incontact(s, b, shoulderradius+bottleradius) DO
{ // They are in contact so make the bottle bounce off
  IF rid=-1 DO
    writef("R%n right shoulder contact with B%n*n", rid, bid)
    cbounce(s, b, 1, 0) // Robot is infinitely heavy
  }
}

// Test for robot left tip bounce
{ LET sx, sy, sxdot, sydot =
  r!r_ltcx, r!r_ltcy,
  r!r_cgxdot, r!r_cgydot
LET s = @sx
IF incontact(s, b, tipradius+bottleradius) DO
{ // They are in contact so make the bottle bounce off
  IF rid=-1 DO
    writef("R%n left tip contact with B%n*n", rid, bid)
    cbounce(s, b, 1, 0) // Robot is heavy
  }
}

// Test for robot right tip bounce
{ LET sx, sy, sxdot, sydot =
  r!r_rtcx, r!r_rtcy,
  r!r_cgxdot, r!r_cgydot
LET s = @sx
IF incontact(s, b, tipradius+bottleradius) DO
{ // They are in contact so make the bottle bounce off
  IF rid=-1 DO
    writef("R%n right tip contact with B%n*n", rid, bid)

```

```

        cbounce(s, b, 1, 0) // Robot is heavy
    }
}

// Test for robot grabber bounces

{ // Make the robot's centre the origin
  LET bx = b!b_cgx - r!r_cgx
  LET by = b!b_cgy - r!r_cgy

  LET c = cosines(r!r_cgxdot, r!r_cgydot) // Direction cosines of the robot
  LET s = result2

  // Rotate clockwise the bottle position about the new origin
  LET tx = inprod(bx, by, c, s)
  LET ty = inprod(bx, by, -s, c)

  // Deal with bounces of the arm edges

  // Calculate the y positions of the arm edges.
  LET y3 = muldiv(robotradius-shoulderradius-armthickness,
                  r!r_grabpos, One) // Right edge of the left arm
  LET y4 = y3 + armthickness        // Left edge of the left arm
  LET y2 = -y3                      // Left edge of the right arm
  LET y1 = -y4                      // Right edge of the right arm

  IF rid=-1 DO // Debugging aid
  { writef("R%n: cg=(%8.3d %8.3d)*n", rid, r!r_cgx, r!r_cgy)
    writef("B%n: cg=(%8.3d %8.3d)*n", bid, b!b_cgx, b!b_cgy)
    writef("bx=%8.3d by=%8.3d*n", bx, by)
    writef("tx=%8.3d ty=%8.3d grablen=%8.3d*n", tx, ty, grablen)
    writef("x1=%8.3d x2=%8.3d*n", robotradius, robotradius+grablen)
    writef("y1=%8.3d y2=%8.3d y3=%8.3d y4=%8.3d*n", y1, y2, y3, y4)
    abort(1234)
  }

  IF robotradius <= tx <= robotradius+grablen DO
  { // Bounces and grabbing are both possible

  IF rid=-1 DO
  { sawritef("R%n: has B%n parallel to grabbers*n", rid, bid)
    abort(1235)
  }

  IF y1 - bottleradius <= ty <= y1 DO
  { // Bottle bounce with outside edge of right arm

```

```

        //LET rtdot = inprod(r!r_cgxdot, r!r_cgydot, c, s)
        LET rwdot = inprod(r!r_cgxdot, r!r_cgydot,-s, c)
        LET btdot = inprod(b!b_cgxdot, b!b_cgydot, c, s)
        LET bwdot = inprod(b!b_cgxdot, b!b_cgydot,-s, c)
        LET v = bwdot-rwdot
IF rid=-1 DO
{ sawritef("B%n: in contact with outside edge of right grabber arm*n", bid)
  abort(1236)
}

    IF v>0 DO
    { bwdot := rebound(v) + rwdot
      // Transform bottle velocity to world coords
      b!b_cgxdot := inprod(btdot,bwdot, c, -s)
      b!b_cgydot := inprod(btdot,bwdot, s, c)
    }
  }

    IF y2 <= ty <= y2 + bottleradius DO
    { // Bottle bounce with the inside edge of right arm
      LET rtdot = inprod(r!r_cgxdot, r!r_cgydot, c, s)
      LET rwdot = inprod(r!r_cgxdot, r!r_cgydot,-s, c)
      LET btdot = inprod(b!b_cgxdot, b!b_cgydot, c, s)
      LET bwdot = inprod(b!b_cgxdot, b!b_cgydot,-s, c)
      LET v = bwdot-rwdot // Speed of bottle away from the right arm
IF rid=-1 DO
{ sawritef("B%n: in contact with inside edge of right grabber arm*n", bid)
  sawritef("rxdot=%8.3d rydot=%8.3d*n", r!r_cgxdot, r!r_cgydot)
  sawritef("bxdot=%8.3d bydot=%8.3d*n", b!b_cgxdot, b!b_cgydot)
  sawritef("c=      %8.3d s=      %8.3d*n", c, s)
  sawritef("rtdot=%8.3d rwdot=%8.3d*n", rtdot, rwdot)
  sawritef("btdot=%8.3d bwdot=%8.3d*n", btdot, bwdot)
  sawritef("v=      %8.3d*n", v)
  abort(1236)
}

    IF v<0 DO
    { bwdot := rebound(v) + rwdot
      // Transform bottle velocity to world coords
IF rid=-1 DO
  sawritef("bxdot=%8.3d bydot=%8.3d*n", b!b_cgxdot, b!b_cgydot)
  b!b_cgxdot := inprod(btdot,bwdot, c, -s)
  b!b_cgydot := inprod(btdot,bwdot, s, c)
IF rid=-1 DO
{ sawritef("bxdot=%8.3d bydot=%8.3d*n", b!b_cgxdot, b!b_cgydot)
  abort(1239)
}
}

```

```

    }
    //IF tydot>0 DO tydot := rebound(tydot)
  }

  IF y3 - bottleradius <= ty <= y3 DO
  { // Bottle collision with right edge of left arm
    //LET rtdot = inprod(r!r_cgxdot, r!r_cgydot, c, s)
    LET rwdot = inprod(r!r_cgxdot, r!r_cgydot,-s, c)
    LET btdot = inprod(b!b_cgxdot, b!b_cgydot, c, s)
    LET bwdot = inprod(b!b_cgxdot, b!b_cgydot,-s, c)
    LET v = bwdot-rwdot
  IF rid=-1 DO
  { sawritef("B%n: in contact with right edge of left grabber*n", bid)
    abort(1237)
  }

    IF v>0 DO
    { bwdot := rebound(v) + rwdot
      // Transform bottle velocity to world coords
      b!b_cgxdot := inprod(btdot,bwdot, c, -s)
      b!b_cgydot := inprod(btdot,bwdot, s, c)
    }
  }

  IF y4 <= ty <= y4 + bottleradius DO
  { // Bottle collision with left edge of left arm
    //LET rtdot = inprod(r!r_cgxdot, r!r_cgydot, c, s)
    LET rwdot = inprod(r!r_cgxdot, r!r_cgydot,-s, c)
    LET btdot = inprod(b!b_cgxdot, b!b_cgydot, c, s)
    LET bwdot = inprod(b!b_cgxdot, b!b_cgydot,-s, c)
    LET v = bwdot-rwdot
  IF rid=-1 DO
  { sawritef("B%n in contact with left edge of left grabber*n", bid)
    abort(1236)
  }

    IF v<0 DO
    { bwdot := rebound(v) + rwdot
      // Transform bottle velocity to world coords
      b!b_cgxdot := inprod(btdot,bwdot, c, -s)
      b!b_cgydot := inprod(btdot,bwdot, s, c)
    }
  }

  IF y2 <= ty <= y3 DO
  { // Bottle b is the grabber area

```

```

IF rid=-1 DO
{ sawritef("B%n: is in R%n's grabber area*n", bid, rid)
  abort(2233)
}

      inareacount := inareacount + 1

      UNLESS b!b_robot DO
      { // The bottle is not dropped and does not have
        // an owner, select it.

          IF r!r_bottle DO
          { // De-select this robot's current bottle
            LET sb = r!r_bottle
            sb!b_robot := 0
            sb!b_grabbed := FALSE
            r!r_bottle := 0
            r!r_inarea := FALSE
            freebottles := freebottles + 1
          }

          r!r_bottle := b
          r!r_inarea := TRUE
          b!b_robot := r
          b!b_grabbed := FALSE
          freebottles := freebottles - 1
        }

        // Test for a bounce off the grabber base
        IF robotradius <= tx <= robotradius+bottleradius DO
        { LET rtdot = inprod(r!r_cgxdot, r!r_cgydot, c, s)
          LET btdot = inprod(b!b_cgxdot, b!b_cgydot, c, s)
          LET bwdot = inprod(b!b_cgxdot, b!b_cgydot, -s, c)
          LET v = btdot-rtdot

        IF rid=-1 DO
        { sawritef("B%n is in contact R%n,s grabber base*n", bid, rid)
          sawritef("grabbedpos = %8.3d*n", grabbedpos)
          abort(2235)
        }

          IF v<0 DO
          { btdot := rebound(v) + rtdot
            // Transform bottle velocity to world coords
            b!b_cgxdot := inprod(btdot,bwdot, c, -s)
            b!b_cgydot := inprod(btdot,bwdot, s, c)
          }
        }
      }

```

```

        }
      }
    }
  }
} // End of bottle loop

// If the selected bottle is the only bottle in this robot's
// grabber area set inarea to TRUE.
r!r_inarea := inareacount=1
}

// (5) Deal with all the bottle-bottle bounces.

FOR bid1 = 1 TO bottlev!0 DO
{ LET b1 = bottlev!bid1 // b1 -> [cgx, cgy, cgxdot, cgydot]

  UNLESS b1!b_dropped DO
  { // Test for bottle-bottle bounces
    FOR bid2 = bid1+1 TO bottlev!0 DO
    { LET b2 = bottlev!bid2 // b2 -> [cgx, cgy, cgxdot, cgydot]
      IF b2!b_dropped LOOP
      IF incontact(b1, b2, bottleradius+bottleradius) DO
        cbounce(b1, b2, 1, 1)
      }
    }
  }
}
//abort(9002)

// Move the robots and their grabber arms.
// All bottles have been seen.
FOR rid = 1 TO robotv!0 DO
{ LET r = robotv!rid
  LET b = r!r_bottle
  LET inarea = r!r_inarea // =TRUE if b is the only bottle in
                        // this robot's grabber area
  LET grabpos, grabposdot = r!r_grabpos, r!r_grabposdot

  UNLESS inarea | b!b_grabbed IF grabposdot=0 & grabpos<1_000 DO
  { grabposdot := +0_600
    r!r_grabposdot := grabposdot
  }

  IF grabposdot DO
  { grabpos := grabpos+grabposdot/sps

```



```

// Increase the speed depending on the distance from the bottle
speed := speed + 15_000

// Increase the speed if the robot is not close to the bottle
UNLESS incontact(r, b, 2*robotradius) DO speed := speed + 56_000

// Make the robot move towards the bottle
r!r_cgxdot := (29 * r!r_cgxdot + muldiv(speed, ct, One)) / 30
r!r_cgydot := (29 * r!r_cgydot + muldiv(speed, st, One)) / 30
}

IF b!b_grabbed DO
{ // Cause the robot to move towards the pit
  LET dx = pit_x - r!r_cgx
  LET dy = pit_y - r!r_cgy
  LET cp = cosines(dx, dy)
  LET sp = result2

  // Make the robot move towards the pit
  r!r_cgxdot := (29 * r!r_cgxdot + muldiv(60_000, cp, One)) / 30
  r!r_cgydot := (29 * r!r_cgydot + muldiv(60_000, sp, One)) / 30
  b!b_cgxdot, b!b_cgydot := r!r_cgxdot, r!r_cgydot
}
}

r!r_cgx := r!r_cgx + r!r_cgxdot/sps
r!r_cgy := r!r_cgy + r!r_cgydot/sps
}

// Move the bottles
FOR bid = 1 TO bottlev!0 DO
{ LET b = bottlev!bid

  IF b!b_dropped LOOP

  b!b_cgx := b!b_cgx + b!b_cgxdot/sps
  b!b_cgy := b!b_cgy + b!b_cgydot/sps
}
}

AND initpitsurf(col) = VALOF
{ // Allocate the pit surface
  LET r1 = pitradius/One
  LET r2 = r1 + edgsize/One

```

```

LET height = 2*r2 + 2
LET width  = height
LET colkey = maprgb(1,1,1)
LET surf   = mksurface(width, height)

selectsurface(surf, width, height)
fillsurf(colkey)
setcolourkey(surf, colkey)

setcolour(col_gray1)
drawfillcircle(r2, r2+1, r2)

setcolour(col)
drawfillcircle(r2, r2+1, r1)

RESULTIS surf
}

AND initbottlesurf(col) = VALOF
{ // Allocate a bottle surface
  LET height = 2*bottleradius/One + 2
  LET width  = height
  LET colkey = maprgb(1,1,1)
  LET surf   = mksurface(width, height)

  selectsurface(surf, width, height)
  fillsurf(colkey)
  setcolourkey(surf, colkey)

  setcolour(col)
  drawfillcircle(bottleradius/One, bottleradius/One+1, bottleradius/One)

  RESULTIS surf
}

AND sine(theta) = VALOF
// theta = 0_000 for 0 degrees
//        = 64_000 for 90 degrees
// Returns a value in range -1_000 to +1_000
{ LET a = theta / 1_000
  LET r = theta MOD 1_000
  LET s = rawsine(a)
  RESULTIS s + (rawsine(a+1)-s)*r/1000
}

```

```

AND cosine(x) = sine(x+64_000)

AND rawsine(x) = VALOF
{ // x is scaled d.ddd with 64.000 representing 90 degrees
  // The result is scaled d.ddd, ie 1_000 represents 1.000
  LET t = TABLE  0,  25,  49,  74,  98, 122, 147, 171,
                 195, 219, 243, 267, 290, 314, 337, 360,
                 383, 405, 428, 450, 471, 493, 514, 535,
                 556, 576, 596, 615, 634, 653, 672, 690,
                 707, 724, 741, 757, 773, 788, 803, 818,
                 831, 845, 858, 870, 882, 893, 904, 914,
                 924, 933, 942, 950, 957, 964, 970, 976,
                 981, 985, 989, 992, 995, 997, 999, 1000,
                 1000

  LET a = x&63
  UNLESS (x&64)=0 DO a := 64-a
  a := t!a
  UNLESS (x&128)=0 DO a := -a
  RESULTIS a
}

AND robotcoords(r) BE
{ // This function calculates the orientation of the robot
  // and the coordinates of all its key points
  LET x, y = r!r_cgxx, r!r_cgy
  LET r1 = robotradius
  LET r2 = shoulderradius
  LET r3 = tipradius
  LET d1 = 2*r3
  LET d2 = muldiv(r!r_grabpos, r1-r2-d1, One)
  LET d3 = grablen
  LET c = cosines(r!r_cgxdot, r!r_cgydot)
  LET s = result2
  LET ns = -s

  r!r_lcx := x + inprod( c,ns, r1-r2, r1-r2) // Left side
  r!r_lcy := y + inprod( s, c, r1-r2, r1-r2)
  r!r_lex := x + inprod( c,ns,   r1, r1-r2)
  r!r_ley := y + inprod( s, c,   r1, r1-r2)

  r!r_rcx := x + inprod( c,ns, r1-r2, r2-r1) // Right side
  r!r_rcy := y + inprod( s, c, r1-r2, r2-r1)
  r!r_rex := x + inprod( c,ns,   r1, r2-r1)
  r!r_rey := y + inprod( s, c,   r1, r2-r1)

```

```

r!r_ltax := x + inprod( c,ns,    r1, d1+d2) // Left arm
r!r_ltax := y + inprod( s, c,    r1, d1+d2)
r!r_ltbx := x + inprod( c,ns,    r1,   d2)
r!r_ltbx := y + inprod( s, c,    r1,   d2)
r!r_ltcx := x + inprod( c,ns, r1+d3,   d2)
r!r_ltcx := y + inprod( s, c, r1+d3,   d2)
r!r_ltdx := x + inprod( c,ns, r1+d3, d1+d2)
r!r_ltdx := y + inprod( s, c, r1+d3, d1+d2)
r!r_ltpx := x + inprod( c,ns, r1+d3, d2+r3)
r!r_ltpx := y + inprod( s, c, r1+d3, d2+r3)

r!r_rtax := x + inprod( c,ns,    r1,-d1-d2) // Right arm
r!r_rtax := y + inprod( s, c,    r1,-d1-d2)
r!r_rtbx := x + inprod( c,ns,    r1,  -d2)
r!r_rtbx := y + inprod( s, c,    r1,  -d2)
r!r_rtcx := x + inprod( c,ns, r1+d3,  -d2)
r!r_rtcx := y + inprod( s, c, r1+d3,  -d2)
r!r_rtdx := x + inprod( c,ns, r1+d3,-d1-d2)
r!r_rtdx := y + inprod( s, c, r1+d3,-d1-d2)
r!r_rtpx := x + inprod( c,ns, r1+d3,-d2-r3)
r!r_rtpx := y + inprod( s, c, r1+d3,-d2-r3)

// Centre of grabbed bottle
r!r_bcx := x + inprod( c,ns, robotradius+2*bottleradius, 0)
r!r_bcy := y + inprod( s, c, robotradius+2*bottleradius, 0)
}

AND drawrobot(r) BE
{ LET b = r!r_bottle

  robotcoords(r)

  setcolour(r!r_id=1 -> robot1colour, robotcolour)

  // Body
  drawfillcircle(r!r_cgx/One, r!r_cgy/One, robotradius/One)
  // Left shoulder
  drawfillcircle(r!r_lcx/One, r!r_lcy/One, shoulderradius/One)
  // Right shoulder
  drawfillcircle(r!r_rcx/One, r!r_rcy/One, shoulderradius/One)

  IF debugging DO
  { // Plot the robot number centred in the robot
    setcolour(col_black)
  }
}

```

```

    plotf(r!r_cgx/One-(r!r_id>=10->9,3), r!r_cgy/One-6, "%n", r!r_id)
}

setcolour(grabbercolour)
// Grabber base
drawquad(r!r_lcx/One, r!r_lcy/One, // lc--le
         r!r_lex/One, r!r_ley/One, // |  |
         r!r_rex/One, r!r_rey/One, // |  |
         r!r_rcx/One, r!r_rcy/One) // rc--re
// Left arm
drawquad(r!r_ltax/One, r!r_ltay/One, // lta-----ltd
         r!r_ltbx/One, r!r_ltbody/One, // |           |
         r!r_ltcx/One, r!r_ltcy/One, // ltb-----ltc
         r!r_ltdx/One, r!r_ltdy/One)
drawfillcircle(r!r_ltpx/One, r!r_ltpy/One, tipradius/One)
// Right arm
drawquad(r!r_rtax/One, r!r_rtay/One, // rta-----rtd
         r!r_rtbx/One, r!r_rtbody/One, // |           |
         r!r_rtcx/One, r!r_rtcy/One, // rtb-----rtc
         r!r_rtdx/One, r!r_rtdy/One)
drawfillcircle(r!r_rtpx/One, r!r_rtpy/One, tipradius/One)

//sawritef("debugging=%n b=%n grabbed=%n dropped=%n*n",
//          debugging, b, b!b_grabbed, b!b_dropped)
IF debugging UNLESS b!b_grabbed | b!b_dropped DO
{ setcolour(col_red)
  moveto(r!r_bcx/One, r!r_bcy/One)
  drawto(b!b_cgx/One, b!b_cgy/One)
//updatescreen()
//abort(1000)
}
}

AND drawbottle(b) BE UNLESS b!b_dropped DO
{ LET r = b!b_robot // Owing robot,if any
  LET surf = bottlesurfR

  IF b!b_id=1 DO surf := bottlesurfK
  IF b!b_robot DO surf := bottlesurfDR

  IF b!b_grabbed DO
  { surf := bottlesurfB
    b!b_cgx := r!r_bcx // If grabbed the bottle is at the centre
    b!b_cgy := r!r_bcy // of the robot's grabber.
  }
}

```

```

blitsurf(surf, screen, (b!b_cgx-bottleradius)/One,
        (b!b_cgy+bottleradius)/One)

IF debugging DO
{ // Plot the bottle number near the bottle
  setcolour(col_black)
  plotf(b!b_cgx/One+10, b!b_cgy/One-6, "%n", b!b_id)
}
}

AND plotscreen() BE
{ LET d = edgsize/One
  selectsurface(screen, screenxsize, screenysize)
  fillsurf(backcolour)

  selectsurface(screen, xsize, ysize)

  setcolour(col_gray1)
  drawquad(0,0, d,d, d,screenysize-d, 0,screenysize)
  setcolour(col_gray2)
  drawquad(0, screenysize,
          d, screenysize-d,
          screenxsize-d, screenysize-d,
          screenxsize,screenysize)
  setcolour(col_gray3)
  drawquad(screenxsize,screenysize,
          screenxsize-d,screenysize-d,
          screenxsize-d,d,
          screenxsize,0)
  setcolour(col_gray4)
  drawquad(0,0, d,d, screenxsize-d,d, screenxsize,0)

  // The pit
  blitsurf(pitsurf, screen,
          (pit_x-pitradius-edgsize)/One, (pit_y+pitradius+edgsize)/One)
  selectsurface(screen, xsize, ysize)

  FOR i = 1 TO robotv!0 DO drawrobot(robotv!i)
  FOR i = 1 TO bottlev!0 DO drawbottle(bottlev!i)
//abort(802)

  setcolour(maprgb(255,255,255))

  IF debugging DO

```

```

{ //plotf(30, 380, "sps          = %i2", sps)
  plotf(80, 365, "freebottles = %i2", freebottles)
  plotf(80, 350, "bottlecount = %i2", bottlecount)
}

IF help DO
{ plotf(30, 165, "H -- Toggle help information")
  plotf(30, 150, "Q -- Quit")
  plotf(30, 135, "X -- Enter the debugger")
  plotf(30, 120, "P -- Pause/Continue")
  plotf(30, 105, "G -- Close the grabber of the Dark green robot")
  plotf(30,  90, "R -- Open the grabber of the Dark green robot")
  plotf(30,  75, "D -- Toggle debugging")
  plotf(30,  60, "U -- Toggle usage")
  plotf(30,  45, "W -- Write debugging info")
  plotf(30,  30, "Arrow keys -- Control the dark green robot")
}

setcolour(maprgb(255,255,255))

IF displayusage DO
  plotf(30, 345, "CPU usage = %i3%% sps = %n", usage, sps)
//updatescreen()
//abort(803)
IF debugging DO
{ LET r = robotv!1
  LET sb = r!r_bottle
  LET b = bottlev!0 -> bottlev!1, 0
  plotf(80, 120, "R1: x=%8.3d y=%8.3d xdot=%8.3d ydot=%8.3d",
    r!r_cgx, r!r_cgy, r!r_cgxdot, r!r_cgydot)
  IF b DO
    plotf(80, 105, "B1: x=%8.3d y=%8.3d xdot=%8.3d ydot=%8.3d",
      b!b_cgx, b!b_cgy, b!b_cgxdot, b!b_cgydot)
  //plotf(80, 85, "  grabpos=%8.3d  grabposdot=%8.3d",
  //  r!r_grabpos, r!r_grabposdot)
  //IF sb DO
  //  plotf(80, 45, "Selected B%i2 grabbed=%n",
  //    (sb -> sb!b_id, 0), (sb -> sb!b_grabbed, FALSE))
//abort(5678)
}
}

AND processevents() BE WHILE getevent() SWITCHON eventtype INTO
{ DEFAULT:
  LOOP

```

```

CASE sdle_keydown:
  SWITCHON capitalch(eventa2) INTO
  { DEFAULT:
    CASE 'H': help := ~help
              LOOP

    CASE 'Q': done := TRUE
              LOOP

    CASE 'D': debugging := ~debugging
              LOOP

    CASE 'X': sawritef("User requested entry to the debugger*n")
                  sawritef("robotv=%n bottlev=%n*n", robotv, bottlev)
                  abort(9999)
                  LOOP

    CASE 'U': displayusage := ~displayusage
              LOOP

    CASE 'W': sawritef("Bottles      = %n*n", bottles)
                  sawritef("Free bottles = %n*n", freebottles)
                  sawritef("Robots      = %n*n", robots)
                  FOR i = 1 TO bottlev!0 DO
                  { LET b = bottlev!i
                    UNLESS b LOOP
                    sawritef("Bottle %i2: ", b!b_id)
                    IF b!b_robot DO sawritef(" robot %i2", b!b_robot!r_id)
                    IF b!b_grabbed DO sawritef(" grabbed")
                    sawritef("*n")
                  }

                  FOR i = 1 TO robotv!0 DO
                  { LET r = robotv!i
                    UNLESS r LOOP
                    sawritef("Robot %i2: ", r!r_id)
                    IF r!r_bottle DO sawritef(" bottle %i2", r!r_bottle!b_id)
                    IF r!r_inarea DO sawritef(" bottle in area")
                    sawritef("*n")
                  }

                  abort(1000)
                  LOOP

```



```

CASE 'G': // Grab
  { LET r = robotv!1
    LET b = r!r_bottle
    // Start closing unless a bottle is already grabbed
    UNLESS b & b!b_grabbed DO r!r_grabposdot := -0_600
    LOOP
  }

CASE 'R': // Release
  { LET r = robotv!1
    LET b = r!r_bottle
    r!r_grabposdot := +0_300
    IF b & b!b_grabbed DO b!b_grabbed := FALSE
    LOOP
  }

CASE 'S': // Start again
  LOOP

CASE 'P': // Toggle stepping
  stepping := ~stepping
  LOOP

CASE sdle_arrowup:
  { LET r = robotv!1
    LET c = cosines(r!r_cgxdot, r!r_cgydot)
    LET s = result2
    r!r_cgxdot := r!r_cgxdot + muldiv(5_000, c, One)
    r!r_cgydot := r!r_cgydot + muldiv(5_000, s, One)
    LOOP
  }

CASE sdle_arrowdown:
  { LET r = robotv!1
    LET c = cosines(r!r_cgxdot, r!r_cgydot)
    LET s = result2
    r!r_cgxdot := r!r_cgxdot - muldiv(4_000, c, One)
    r!r_cgydot := r!r_cgydot - muldiv(4_000, s, One)
    LOOP
  }

CASE sdle_arrowright:
  { LET r = robotv!1
    LET xdot = r!r_cgxdot

```

```

        LET ydot = r!r_cgydot
        LET dc = cosine(4_000)
        LET ds = sine(4_000)
        r!r_cgxdot := inprod(xdot,ydot, dc, ds)
        r!r_cgydot := inprod(xdot,ydot,-ds, dc)
        LOOP
    }

CASE sdle_arrowleft:
    { LET r = robotv!1
      LET xdot = r!r_cgxdot
      LET ydot = r!r_cgydot
      LET dc = cosine(4_000)
      LET ds = - sine(4_000)
      r!r_cgxdot := inprod(xdot,ydot, dc, ds)
      r!r_cgydot := inprod(xdot,ydot,-ds, dc)
      LOOP
    }
}

CASE sdle_quit:
    writef("QUIT*n");
    done := TRUE
    LOOP
}

AND nearedge(x, y, dist) = VALOF
{ //writef("nearedge: x=%n y=%n dist=%n xsize=%n ysize=%n*n",
  //      x/One, y/One, dist/One, xsize, ysize)
  //abort(2000)
  UNLESS dist < x < xsize*One - dist RESULTIS TRUE
  UNLESS dist < y < ysize*One - dist RESULTIS TRUE
  //writef("=> FALSE*n")
  //abort(2001)
  RESULTIS FALSE
}

AND nearthepit(x, y, dist) = VALOF
{ LET cx = pit_x
  LET cy = pit_y
  LET dx = ABS(x - cx)
  LET dy = ABS(y - cy)
  //writef("nearthepit: x=%n y=%n cx=%n cy=%n dist=%n*n",
  //      x/One, y/One, cx/One, cy/One, dist/One)
  //abort(3000)
}

```

```

    IF dx < dist & dy < dist RESULTIS TRUE
//writef("=> FALSE*n")
//abort(3001)
    RESULTIS FALSE
}

AND nearbottle(x, y, b, dist) = VALOF
{ // Return TRUE if (x,y) is near bottle b.
  // (x,y) is the position of either a robot or a bottle.
  LET bx = b!b_cgx
  LET by = b!b_cgy
  LET dx = ABS(x - bx)
  LET dy = ABS(y - by)
//writef("nearbottle: bid=%n x=%n y=%n bx=%n by=%n dx+dy=%n dist=%n*n",
//      b!b_id, x/One, y/One, bx/One, by/One, (dx+dy)/One, dist/One)
//abort(4000)
  IF dx < dist & dy < dist RESULTIS TRUE

//writef("=>FALSE*n")
//abort(4001)
  RESULTIS FALSE
}

AND nearanybottle(bid, x, y, dist) = VALOF
{ // Return TRUE if (x,y) near a bottle other than bottle bid
  // If bid=0, (x,y) is the position of a robot.
  FOR i = 1 TO bottlev!0 UNLESS i=bid IF nearbottle(x, y, bottlev!i, dist)
    RESULTIS TRUE
  RESULTIS FALSE
}

AND nearrobot(x, y, r, dist) = VALOF
{ // Return TRUE if (x,y) is near robot r.
  // (x,y) is the position of either a robot or a bottle.
  LET rx = r!r_cgx
  LET ry = r!r_cgy
  LET dx = ABS(x - rx)
  LET dy = ABS(y - ry)
//sawwritef("nearrobot: rib=%i2 x=%n y=%n rx=%n ry=%n dx+dy=%n dist=%n*n",
//      r!r_id, x/One, y/One, rx/One, ry/One, (dx+dy)/One, dist/One)
//abort(5000)
  IF dx < dist & dy < dist RESULTIS TRUE

//sawwritef("=>FALSE*n")

```

```

//abort(5001)
  RESULTIS FALSE
}

AND nearanyrobot(rid, x, y, dist) = VALOF
{ // Return TRUE if (x,y) near a robot other than robot rid
  // If rid=0, (x,y) is the position of a bottle.
  FOR i = 1 TO robotv!0 DO
    UNLESS i=rid IF nearrobot(x, y, robotv!i, dist) RESULTIS TRUE
  RESULTIS FALSE
}

LET start() = VALOF
{ LET argv = VEC 50
  LET stepmsecs = ?
  LET comptime = 0 // Amount of cpu time per frame
  LET day, msecs, filler = 0, 0, 0
  //datstamp(@day)
  seed := 5 //msecs // Set seed based on time of day
  //msecs0 := msecs // Set the starting time
  //msecsnow := 0

  UNLESS rdargs("-b/n,-r/n,-sx/n,-sy/n,-s/n,-d/s",
               argv, 50) DO
  { writef("Bad arguments for robots*n")
    RESULTIS 0
  }

  bottles := 35
  robots := 7
  //bottles := 20
  //robots := 6
  //bottles := 1
  //robots := 1

  xsize := 700
  ysize := 500

  IF argv!0 DO bottles := !(argv!0) // -b/n
  IF argv!1 DO robots := !(argv!1) // -r/n
  IF argv!2 DO xsize := !(argv!2) // -sx/n
  IF argv!3 DO ysize := !(argv!3) // -sy/n
  IF argv!4 DO seed := !(argv!4) // -s/n
  debugging := argv!5 // -d/s
}

```

```

help := FALSE

IF bottles < 0 DO bottles := 0
IF bottles > 100 DO bottles := 100
IF robots < 1 DO robots := 1
IF robots > 30 DO robots := 30

freebottles := bottles
bottlecount := bottles
setseed(seed)

UNLESS sys(Sys_sdl, sdl_avail) DO
{ writef("The SDL features are not available\n")
  RESULTIS 0
}

spacev := getvec(spacevupb)

UNLESS spacev DO
{ writef("Insufficient space available\n")
  RESULTIS 0
}

spacep, spacet := spacev, spacev+spacevupb

IF FALSE DO
{ // Code to test the cosines function
  LET e1, e2, rsq = One, One, One
  LET x, y, xdot, ydot, c, s = 0, 0, One, 0, One, 0
  LET p = @x
  FOR dy = 0 TO One BY One/100 DO
  { ydot := dy
    c := cosines(xdot, ydot)
    s := result2
    rsq := inprod(c,s, c,s)
    writef("dx=%8.3d dy=%8.3d cos=%8.3d sin=%8.3d rsq=%8.3d\n",
          One, dy, c, s, rsq)
    IF e1 < rsq DO e1 := rsq
    IF e2 > rsq DO e2 := rsq
  }
  writef("Errors +%7.3d -%7.3d\n", e1-One, One-e2)
abort(1000)
  RESULTIS 0
}

```

```

}

// Initialise the priority queue
priq := mkvec(200)
priqn, priqpb := 0, 200

initsdl()
mkscreen("Robots -- Press H for Help", xsize, ysize)

backcolour      := maprgb(100,100,100)
col_red         := maprgb(255, 0, 0)
col_darkred     := maprgb(196, 0, 0)
col_black       := maprgb( 0, 0, 0)
col_brown       := maprgb(100, 50, 20)
col_gray1       := maprgb(110,110,110)
col_gray2       := maprgb(120,120,120)
col_gray3       := maprgb(130,130,130)
col_gray4       := maprgb(140,140,140)
pitcolour       := maprgb( 20, 20,100)
robotcolour     := maprgb( 0,255, 0)
robot1colour    := maprgb( 0,120, 40)
grabbercolour   := maprgb(200,200, 40)

bottlesurfR := initbottlesurf(col_red)
bottlesurfDR := initbottlesurf(col_darkred)
bottlesurfK := initbottlesurf(col_black)
bottlesurfB := initbottlesurf(col_brown)
pitsurf      := initpitsurf(pitcolour)

pit_x, pit_y := xsize*One/2, ysize*One/2
pit_xdot, pit_ydot := 0, 0
thepit := @pit_x

// Initialise robotv
robotv := mkvec(robots)
robotv!0 := 0
FOR i = 1 TO robots DO
{ LET r = mkvec(r_upb)
  LET x = ?
  LET y = ?

  UNLESS r DO
  { sawritef("More space needed*n")
    abort(999)
  }
}

```

```

FOR j = 0 TO r_upb DO r!j := 0

FOR k = 1 TO 200 DO
  { x := randno(xsize*One)
    y := randno(ysize*One)
    UNLESS nearedge (x, y, robotradius) |
      nearthepit (x, y, pitradius+2*robotradius) |
      nearanyrobot(i, x, y, 3*robotradius) BREAK
  //writef("R%i2: x=%8.3d y=%8.3d no good*n", i, x, y)
  //abort(1000)
  IF k>150 DO
    { writef("Too many robots to place*n")
      abort(999)
    }
  }
}

//writef("R%i2: x=%8.3d y=%8.3d good*n", i, x, y)
//abort(1005)

robotv!0 := i
robotv!i := r

// Position
r!r_cgx      := x
r!r_cgy      := y

// Motion
r!r_cgxdot   := randno(40_000) - 20_000
r!r_cgydot   := randno(40_000) - 20_000

// grabber
r!r_grabpos  := 1_000      // The grabber is fully open
r!r_grabposdot := 0_000
r!r_bottle   := 0          // No grabbed bottle
r!r_id := i
robotcoords(r)
}
//abort(1001)
// Initialise bottlev
bottlev := mkvec(bottles)
bottlev!0 := 0
FOR i = 1 TO bottles DO
  { LET b = mkvec(b_upb)
    LET x = ?

```

```

LET y = ?

UNLESS b DO
{ sawritef("More space needed*n")
  abort(999)
}

FOR j = 0 TO b_upb DO b!j := 0

//FOR k = 1 TO 1000 DO
{ // Choose a random position for the next bottle
  x := randno(xsize*One)
  y := randno(ysize*One)
//sawritef("Calling nearedge*n")
  UNLESS nearedge (x, y, 4*bottleradius) |
    nearthepit(x, y, 4*bottleradius) |
    nearanyrobot (0, x, y, 2*robotradius) |
    nearanybottle(i, x, y, 4*bottleradius) BREAK
  //IF k > 200 DO
  //{ writef("Too many bottles to place*n")
  // abort(999)
  // BREAK
  //}
} REPEAT

bottlev!0 := i
bottlev!i := b
b!b_cgxx := x
b!b_cgyy := y
b!b_cgxdot := randno(50_000) - 25_000
b!b_cgydot := randno(50_000) - 25_000
b!b_grabbed := FALSE
b!b_robot := 0 // No grabbing robot
b!b_dropped := FALSE
b!b_id := i
}
//abort(1002)

stepping := TRUE // =FALSE if not stepping
usage := 0
//debugging := FALSE
displayusage := FALSE
sps := 10 // Initial setting
stepmsecs := 1000/sps

```



```

wall_wx := 0
wall_ex := (screenxsize-1)*One // East wall

wall_sy := 0 // South wall
wall_ny := (screenysize-1)*One // North wall

done := FALSE

//{ LET r1, r2 = robotv!1, robotv!2
//r1!r_cgx, r1!r_cgy := 400_000, 100_000
//r2!r_cgx, r2!r_cgy := 400_000+robotradius*5, 100_000+00_000
//r1!r_cgxdot, r1!r_cgydot := 10_000, 0_000
//r2!r_cgxdot, r2!r_cgydot := 0, -1_000
//}

//abort(1003)
UNTIL done DO
{ LET t0 = sdlmsecs()
  LET t1 = ?

  processevents()

  IF stepping DO step()
//abort(922)
  usage := 100*comptime/stepmsecs

  plotscreen()
  updatescreen()

  UNLESS 80<usage<95 DO
  { TEST usage>90
    THEN sps := sps-1
    ELSE sps := sps+1
    IF sps<1 DO sps := 1 // To stop division by zero
    stepmsecs := 1000/sps
  }

  t1 := sdlmsecs()

  comptime := t1 - t0
  IF t0+stepmsecs > t1 DO sdlldelay(t0+stepmsecs-t1)
}

writef("*nQuitting*n")
sdlldelay(0_200)

```

```

IF bottlesurfR D0 freesurface(bottlesurfR)
IF bottlesurfDR D0 freesurface(bottlesurfDR)
IF bottlesurfK D0 freesurface(bottlesurfK)
IF bottlesurfB D0 freesurface(bottlesurfB)
IF pitsurf      D0 freesurface(pitsurf)

closesdl()

fin:
  IF spacev D0 freevec(spacev)
  RESULTIS 0
}

```

5.16 Moon Lander

This is a re-implementation of a moon lander program originally written in September 1973 for the PDP-7 and the Vector General display. It now uses the SDL graphics library and runs under Linux, the Raspberry Pi and Windows. If you run the program (`bcplprogs/raspi/lander.b`) without touching any of the controls the lander makes a perfect landing.

```

GET "libhdr"
GET "sdl.h"
GET "sdl.b"           // Insert the library source code
.
GET "libhdr"
GET "sdl.h"

MANIFEST {
  fuelmax=4000000
}

STATIC {
  shape=9111
  rotforce=0//50

  /* Perfect landing
  cgx= 322_855_260 // in millimetres
  cgy= 129_712_464 -16000 +3000
  theta= 3232
  cgxdot=-526_837 // in millimetres per second
  cgydot= -0_357
  thetadot= 32

```

```
/**/

/* Take off
cgx=-37000000
cgy=28001
theta=64*1000
cgxdot=0
cgydot=1
thetadot=-32
*/

minscale = 400

fuel=fuelmax
thrust=450
dthrust=50
target=-37000000
halftargetsize=30_000 // in millimetres
scale=4
weight=300
mass=1
moonradius = 8000*#x1000 * 7 / 22 // circumference/pi
costheta=0
sintheta=0
flamelength=0
x0=0
y0=0
thrustmax=2000
thrustmin=100
single=FALSE
novice=FALSE
delay=1
offscreen=TRUE
ch=0
tracing=FALSE
}

GLOBAL {
  done:ug
  rotleft
  rotright

  landed // Quality of the landing
  toofast // Quality of the landing
```

```
    badsite
    badorientation
    goodlanding
    stepping

    col_black
    col_blue
    col_green
    col_yellow
    col_red
    col_magenta
    col_cyan
    col_white
    col_darkgray
    col_darkblue
    col_darkgreen
    col_darkyellow
    col_darkred
    col_darkmagenta
    col_darkcyan
    col_gray
    col_lightgray
    col_lightblue
    col_lightgreen
    col_lightyellow
    col_lightred
    col_lightmagenta
    col_lightcyan
}

LET start() = VALOF
{ LET mes = VEC 256/bytesperword

  writes("*nMoon Lander*n")

  initsdl()

  mkscreen("Moon Lander", 640, 480)

  rotleft, rotright := FALSE, TRUE

  startlander(format)

  //Update screen
  updatescreen()
```

```

//Pause for 10 secs
sdlldelay(10_000);

//Quit SDL
closesdl()

writef("Done!*n")

RESULTIS 0
}

AND startlander(fmt) = VALOF
{ LET count = 0

  // Declare a few colours in the pixel format of the screen
  col_black      := maprgb( 0,  0,  0)
  col_blue       := maprgb( 0,  0, 255)
  col_green      := maprgb( 0, 255,  0)
  col_yellow     := maprgb( 0, 255, 255)
  col_red        := maprgb(255,  0,  0)
  col_majenta    := maprgb(255,  0, 255)
  col_cyan       := maprgb(255, 255,  0)
  col_white      := maprgb(255, 255, 255)
  col_darkgray   := maprgb( 64,  64,  64)
  col_darkblue   := maprgb(  0,  0,  64)
  col_darkgreen  := maprgb(  0,  64,  0)
  col_darkyellow := maprgb(  0,  64,  64)
  col_darkred    := maprgb( 64,  0,  0)
  col_darkmajenta := maprgb( 64,  0,  64)
  col_darkcyan   := maprgb( 64,  64,  0)
  col_gray       := maprgb(128, 128, 128)
  col_lightblue  := maprgb(128, 128, 255)
  col_lightgreen := maprgb(128, 255, 128)
  col_lightyellow := maprgb(128, 255, 255)
  col_lightred   := maprgb(255, 128, 128)
  col_lightmajenta:= maprgb(255, 128, 255)
  col_lightcyan  := maprgb(255, 255, 128)

  fillscreen(col_gray)

  IF FALSE DO
  { LET days, msecs, flag = ?, ?, ?
    datstamp(@days)
  }
}

```

```

// Draw some random coloured lines rapidly
setcolour(col_blue)
drawpoint(screenxsize/2, screenysize/2)
FOR i = 1 TO 100_000 DO
{ LET col = maprgb(randno(255),randno(255),randno(255))
  LET x, y = randno(screenxsize)-1, randno(screenysize)-1
  IF i=10 DO setcaption("Hello World Again")
  setcolour(col)
  drawto(x, y)
  updatescreen()
  //sdlldelay(100)
  IF i MOD 100 = 99 DO
  { LET d, m, f = ?, ?, ?
    datstamp(@d)
    writef("%8.3d frames per second*n", 100000_000/(m-msecs))
    days, msecs, flag := d, m, f
  }
}
RESULTIS 0
}

lander()
RESULTIS 0
}

AND lander() BE
{ single := TRUE
  delay := 0
  landed := FALSE
  stepping := TRUE

  done := FALSE
  UNTIL done DO
  { readcontrols()
    IF stepping DO step()
    sdlldelay(100)
  }

  WHILE sys(Sys_pollsardch)=pollingch LOOP
  writes("*nPress any key*n")
  sys(Sys_sardch)
  newline()
}

AND setwindow() BE

```

```

{ // Set the position and scale of the window to display
  // ie set x0, y0 and scale.
  LET x, y = x0, y0
  LET h = height(cgx)
  LET relheight = ABS(cgy-h)

  // Choose scale so that relheight appears no larger than half screenysize
  LET s = relheight*2/screenysize
  scale := minscale
  UNTIL scale > s DO scale := scale*2

  // Adjust y so that the moon's surface is suitably placed
  UNLESS screenysize*2/10 < (h-y)/scale < screenysize*4/10 DO
    y := h - (screenysize*3/10)*scale

  UNLESS screenysize/ 8 < (h-y0)/scale < screenysize/3 &
    screenysize/10 < (cgy-y0)/scale < screenysize*9/10 DO y0 := y

  IF screenxsize/4 > (cgx-x0)/scale DO x0 := cgx - (screenxsize*3/5)*scale
  IF screenxsize*3/4 < (cgx-x0)/scale DO x0 := cgx - (screenxsize*2/5)*scale

  IF tracing DO
  { writef("cgx=%n cgy=%n h=%n scale=%n x=%n y=%n*n",
          cgx, cgy, h, scale, (cgx-x0)/scale, (cgy-y0)/scale)
    writef("screenxsize=%n screenysize=%n*n", screenxsize, screenysize)
  }
}

AND readcontrols() BE
{ WHILE getevent(@eventtype) SWITCHON eventtype INTO
  { DEFAULT:
    writef("Unknown event type = %n*n", eventtype)
    LOOP

  CASE sdle_active: // => 1
    //writef("active %d %d*n", eventa1, eventa2)
    LOOP

  CASE sdle_keydown: // => 2 mod ch
    SWITCHON capitalch(eventa2) INTO
    { DEFAULT: LOOP
      CASE '.',': rotforce := rotforce - 1
        IF rotforce<-1 DO rotforce := -1
        LOOP
      CASE ',': rotforce := rotforce + 1
    }
  }
}

```

```

                IF rotforce>1 DO rotforce := 1
                LOOP
CASE 'Z': thrust := thrust - dthrust; LOOP
CASE 'X': thrust := thrust + dthrust; LOOP
CASE 'T': tracing := ~tracing; LOOP
CASE 'P': stepping := ~stepping LOOP
CASE 'Q': done := TRUE; LOOP
}
LOOP

CASE sdle_keyup: // => 3 mod ch
//writef("keyup %d %d*n", eventa1, eventa2)
LOOP

CASE sdle_mousemotion: // 4
//writef("mousemotion %n %n %n*n", eventa1, eventa2, eventa3)
LOOP

CASE sdle_mousebuttondown: // 5
//writef("mousebuttondown*n", eventa1, eventa2, eventa3)
LOOP

CASE sdle_mousebuttonup: // 6
//writef("mousebuttonup*n", eventa1, eventa2, eventa3)
LOOP

CASE sdle_joyaxismotion: // 7
{ LET which = eventa1
LET axis = eventa2
LET value = eventa3
//writef("joyaxismotion %n %n %n*n", eventa1, eventa2, eventa3)

SWITCHON axis INTO
{ DEFAULT:
LOOP

CASE 0: // Aileron
rotforce := 0
IF value > 0 DO rotforce := -1
IF value < 0 DO rotforce := +1
LOOP

CASE 1: // Elevator
LOOP

```



```

        CASE 2: // Throttle
            thrust := thrustmax - muldiv(thrustmax-thrustmin, value+32769, 32768+32767)
            LOOP
        }
    }

CASE sdle_joyballmotion: // 8
    //writef("joyballmotion*n", eventa1, eventa2, eventa3)
    LOOP

CASE sdle_joyhatmotion: // 9
    //writef("joyhatmotion*n", eventa1, eventa2, eventa3)
    LOOP

CASE sdle_joybuttondown: // 10
    //writef("joybuttondown*n", eventa1, eventa2, eventa3)
    LOOP

CASE sdle_joybuttonup: // 11
    //writef("joybuttonup*n", eventa1, eventa2, eventa3)
    LOOP

CASE sdle_quit: // 12
    writef("QUIT*n");
    LOOP

CASE sdle_syswmevent: // 13
    //writef("syswmevent*n", eventa1, eventa2, eventa3)
    LOOP

CASE sdle_videoresize: // 14
    //writef("videoresize*n", eventa1, eventa2, eventa3)
    LOOP

CASE sdle_userevent: // 15
    //writef("userevent*n", eventa1, eventa2, eventa3)
    LOOP
}
}

AND step() BE
{ thetadot := thetadot + 20*rotforce

theta := theta + thetadot
IF novice DO theta, thetadot := theta+15*thetadot, 0

```

```

costheta := cosine(theta) // scaled d.ddd
sintheta := sine(theta)

IF thrust > thrustmax DO thrust := thrustmax
IF thrust < thrustmin DO thrust := thrustmin
IF fuel>0 DO { fuel := fuel - thrust
              IF fuel<0 DO fuel := 0
              }
IF fuel<=0 DO thrust := 0
flamlength := thrust*30000/thrustmax
cgxdot := cgxdot + (thrust*costheta/1000          )/mass
cgydot := cgydot + (thrust*sintheta/1000 - weight)/mass
// Add the effect of centrifugal force.
// This should allow the lander to remain in orbit, if cgxdot large enough.
///cgydot := cgydot + muldiv(cgxdot, cgxdot, cgy+moonradius)

cgx := cgx + cgxdot
cgy := cgy + cgydot

//writef("x=%n, y=%n*n", cgx, cgy)

IF tracing DO
{ writef("*nxdot= %n, %n*n", cgxdot, cgydot)
  writef("t,tdot = %n, %n*n", theta, thetadot)
  writef("x=%n, y=%n*n", cgx, cgy)
  writef("h = %n*n", height(cgx))
//   writef("x0y0= %n, %n*n", x0, y0)
//   writef("scale = %n*n", scale)
}

// The CG of the lander is 3 metre above the feet.
IF cgy <= height(cgx)+3_000 DO
{ toofast := FALSE
  badsite := FALSE
  badorientation := FALSE
  goodlanding := TRUE
  landed, thrust := TRUE, 0
  stepping := FALSE
  writes("*nLanded*n")
  writef("xdot = %7.3d ydot = %7.3d*n", cgxdot, cgydot)
  UNLESS 0 < cgxdot*cgxdot+cgydot*cgydot < 1_500*1_500 DO
  { goodlanding := FALSE // Speed greater than 1.5 metre per second
    toofast := TRUE
    writef("Too fast*n")
  }
}

```

```

    }
    // The craft width is 12 metres
    UNLESS ABS(height(cgx-6_000) - height(cgx)) +
        ABS(height(cgx+6_000) - height(cgx)) < 1000 DO
    { // Not level enough
        goodlanding := FALSE
        badsite := TRUE
        writef("Bad landing site*n")
    }
    UNLESS sintheta>950 DO
    { // Bad orientation
        goodlanding := FALSE
        badorientation := TRUE
        writes("Bad orientation*n")
    }
    IF goodlanding DO writes("Perfect, Well done!!*n")
}

displayall()
}

AND height(x) = VALOF
{ IF -halftargetsize < x-target < halftargetsize DO x := target

x := x/8000

{ LET ra, rb, rc = x&#777, x&#77, x&#7
  LET a, b, c = x-ra, x-rb, x-rc
  LET h = (hf(a)*(&#777-ra) + hf(a+&#1000)*ra +
            hf(b)*(&#77 -rb) + hf(b+&#100) *rb +
            hf(c)*(&#7 -rc) + hf(c+&#10) *rc)/512
  h := h*h/100
  IF (hf(x&-2)&#71)=0 DO h := h+4
  RESULTIS h*6*1000
}
}

AND hf(n) = VALOF
{ LET a = n XOR shape
  LET b = a*(a XOR &#4132)/100 + a
  RESULTIS (b*b/313*a) & 255
}

AND cdrawto(x, y) BE
{ LET tx = x / minscale

```

```

    AND ty = y / minscale
//writef("cdrawto: %n,%n ", x, y)
    x := (+tx*sintheta + ty*costheta)/1000 + (cgx-x0)/scale
    y := (-tx*costheta + ty*sintheta)/1000 + (cgy-y0)/scale
//writef(" %n,%n*n", x, y)
    drawto(x, y)
}

```

```

AND cpoint(x, y) BE
{ LET tx = x / minscale
  AND ty = y / minscale
  x := (+tx*sintheta + ty*costheta)/1000 + (cgx-x0)/scale
  y := (-tx*costheta + ty*sintheta)/1000 + (cgy-y0)/scale
  drawpoint(x, y)
}

```

```

AND plotcraft() BE
{ setcolour(col_white)

```

```

// The units are millimetres
// The craft width is 12 metres (-6 to +6)
cpoint( -3000, -2000) // The base
cdrawto ( 3000, -2000)
cdrawto ( 3000, 0)
cdrawto ( -3000, 0)
cdrawto ( -3000, -2000)

```

```

cpoint( 1000, 0) // The return module
cdrawto ( 2000, 1000)
cdrawto ( 2000, 3000)
cdrawto ( 1000, 4000)
cdrawto ( -1000, 4000)
cdrawto ( -2000, 3000)
cdrawto ( -2000, 1000)
cdrawto ( -1000, 0)

```

```

cpoint( -3000, -1000) // Lhe legs
cdrawto ( -5000, -3000)
cpoint( -6000, -3000)
cdrawto ( -4000, -3000)
cpoint( 3000, -1000)
cdrawto ( 5000, -3000)
cpoint( 4000, -3000)
cdrawto ( 6000, -3000)

```

```

setcolour(col_cyan)
IF thrust DO
{ cpoint(    0, -3000) // The flame
  cdrawto ( -2000, -flamelength-3000)
  cdrawto (    0, -flamelength/2-3000)
  cdrawto ( 2000, -flamelength-3000)
  cdrawto (    0, -3000)
}

IF thrust DO
{ IF rotforce>0 DO
  { setcolour(col_yellow)
    cpoint(-3000,    0) // Rotate left jets
    cdrawto( -3500, 2000)
    cdrawto( -2500, 2000)
    cdrawto( -3000,    0)
    cpoint( 3000,-2000)
    cdrawto( 2500,-4000)
    cdrawto( 3500,-4000)
    cdrawto( 3000,-2000)
  }
}

IF rotforce<0 DO
{ setcolour(col_yellow)
  cpoint( 3000,    0) // Rotate right jets
  cdrawto( 3500, 2000)
  cdrawto( 2500, 2000)
  cdrawto( 3000,    0)
  cpoint(-3000,-2000)
  cdrawto( -2500,-4000)
  cdrawto( -3500,-4000)
  cdrawto( -3000,-2000)
}
}

}

AND plotmoon() BE
{ LET x, dx = 0, 4//screenxsize/128

  setcolour(col_lightblue)

```

```

drawpoint(x, (height(x0)-y0)/scale)
WHILE x<screenxsize DO
{ x := x+dx
  drawto(x, (height(x0+scale*x)-y0)/scale)
}

setcolour(col_lightmagenta)
drawpoint((target-halftargetsize-x0)/scale, (height(target)-y0)/scale)
drawto ((target+halftargetsize-x0)/scale, (height(target)-y0)/scale)
}

AND displayall() BE
{ LET xm = screenxsize/2
  LET targy = screenysize - 60
  LET fuely = screenysize - 30
  LET fuelxl = xm - 100
  LET fuelxh = xm + 100
  LET fuelx = fuelxl + muldiv(200, fuel, fuelmax)
  LET targx = xm + (target-cgx)/100000
  LET targx1 = xm + (target-cgx)/1000000
  LET tdotx = xm - thetadot/8
  LET tdoty = fuely-15
  LET flx0, fly0 = xm, fuely-100
  LET flxs, flys = flamelength*costheta/1000, flamelength*sintheta/1000

  sys(Sys_sdl, sdl_fillsurf, screen, col_darkgray)
  setwindow()

  setcolour(col_cyan)          // Fuel
  drawpoint(fuelxl, fuely)
  drawby(200, 0)
  setcolour(col_red)
  drawpoint(fuelx, fuely)
  drawby(0, 20)

  setcolour(col_lightmagenta) // Target
  drawpoint(targx-10, targy)
  drawby(20, 0)
  drawpoint(targx1-5, targy-2)
  drawby(5, 0)

  setcolour(col_cyan)          // Thetadot
  drawpoint(xm, fuely)
  drawby(0, -15)
  setcolour(col_red)

```

```

drawpoint(tdotx, tdoty)
drawby(0, -15)

setcolour(col_lightgreen) // Acceleration
drawpoint(flx0, fly0)
drawby(flxs/200, flys/200)

setcolour(col_red) // Velocity
drawpoint(flx0, fly0)
drawby(cgxdot/10_000, cgydot/10_000)

{ LET x = flx0+cgxdot/200-1
  LET y = fly0+cgydot/200-1
  drawfillrect(x, y, x+3, y+3) // Velocity/200
}

setcolour(col_white)
plotf(10, 75, "target %11.3d", target-cgx)
plotf(10, 60, "cgx= %11.3d xdot=%9.3d", cgx, cgxdot)
plotf(10, 45, "cgy= %11.3d ydot=%9.3d", cgy, cgydot)
plotf(10, 30, "fuel= %11.3d", fuel)
//plotf(10, 15, "scale= %11.3d", scale)

IF landed DO
{ LET x = screenxsize/2
  LET y = screenysize/2
  plotf(x, y, "Landed")
  IF toofast DO { y := y-15; plotf(x, y, "Too fast") }
  IF badsite DO { y := y-15; plotf(x, y, "Bad site") }
  IF badorientation DO { y := y-15; plotf(x, y, "Bad orientation") }
  IF goodlanding DO { y := y-15; plotf(x, y, "Perfect landing -- well done!") }
}

plotmoon()
plotcraft()

ret1:
  updatescreen()
}

AND rdjoystick() = 0

AND rdn() = VALOF
{ LET res = 0
  ch := sys(10)

```

```

    WHILE '0'<=ch<='9' DO { res := 10*res + ch - '0'
                          ch := sys(10)
                          }
    RESULTIS res
}

AND sine(theta) = VALOF
// theta =      0 for 0 degrees
//      = 64000 for 90 degrees
// Returns a value in range -1000 to 1000
{ LET a = theta / 1000
  LET r = theta REM 1000
  LET s = rawsine(a)
  RESULTIS s + (rawsine(a+1)-s)*r/1000
}

AND cosine(x) = sine(x+64_000)

AND rawsine(x) = VALOF
{ // x is scaled d.ddd with 64.000 representing 90 degrees
  // The result is scaled d.ddd, ie 1000 represents 1.000
  LET t = TABLE  0,  25,  49,  74,  98, 122, 147, 171,
                 195, 219, 243, 267, 290, 314, 337, 360,
                 383, 405, 428, 450, 471, 493, 514, 535,
                 556, 576, 596, 615, 634, 653, 672, 690,
                 707, 724, 741, 757, 773, 788, 803, 818,
                 831, 845, 858, 870, 882, 893, 904, 914,
                 924, 933, 942, 950, 957, 964, 970, 976,
                 981, 985, 989, 992, 995, 997, 999, 1000,
                 1000

  LET a = x&63
  UNLESS (x&64)=0 DO a := 64-a
  a := t!a
  UNLESS (x&128)=0 DO a := -a
  RESULTIS a
}

```

As the lander approaches the landing site, the screen should look something like the following.

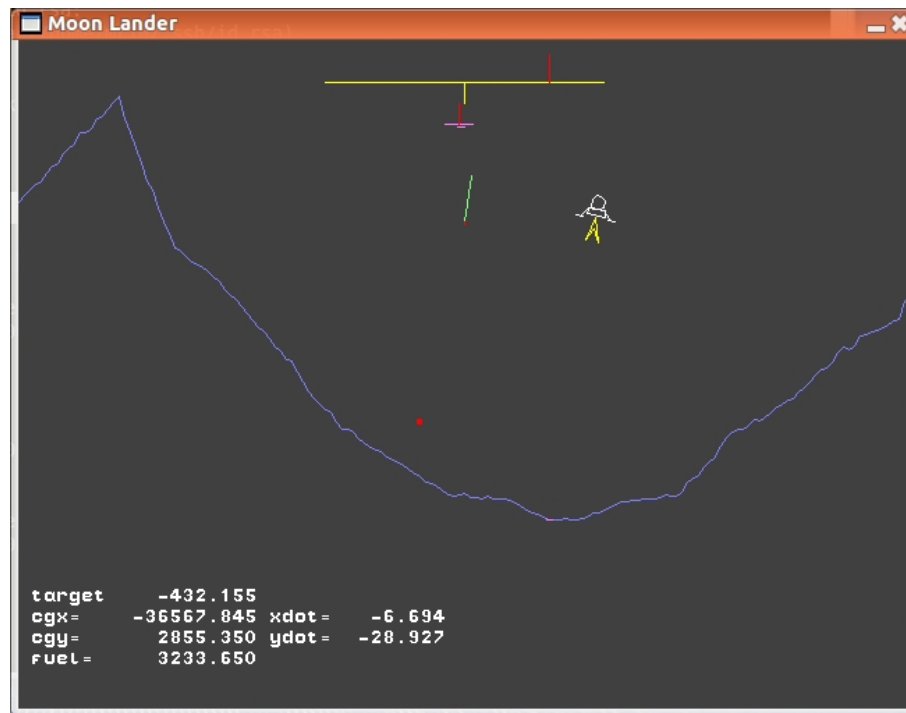

5.17 A Library for High Precision Arithmetic

You may well wonder why there is a section here covering a library for high precision arithmetic when we have seen simple examples of such arithmetic already. The reason is that the next two sections concern the tracing of rays of light through a catadioptric telescope and optics is renowned for needing high precision arithmetic including functions for division and square root. Efficient implementations of these two functions make use of Newton-Raphson iterations which have only recently been covered in page 360. The programs also use of SDL graphics which have only just been covered.

For convenience, the library is located in `BCPL/cintcode/g` and consists of a `arith.b` and a header file `arith.h`. Programs using this library should typically start as follows.

```

GET "libhdr"
MANIFEST {
  ArithGlobs=350 // The first global used by the arith library
  numupb=2+25   // Room for the sign, the exponent and 25 radix
                // digits, equivalent to 100 decimal digits.
}
                // Each radix digit is in the range 0 to 9999
GET "arith.h"
GET "arith.b"

```

The constant `ArithGlobs` allows the user to avoid global number clashes with other libraries. The constant `numupb` specifies the precision of numbers used internally by the library particularly in the implementation of divide and square root. Numbers in the user's program will normally use a slightly lower precision.

The header file `arith.h` contains the following declarations.

```
GLOBAL {
  str2num: ArithGlobs
  setzero
  settok
  copy
  copyu
  addcarry
  roundnum
  standardize
  addu
  add
  subu
  sub
  neg
  mul
  mulbyk
  div
  divbyk
  exptok
  sqrt
  inprod
  radius
  normalize
  iszero
  numcmpu
  numcmp
  integerpart
  roundtoint
  prnum
  checknum
}
```

The file `arith.b` contains the definitions of all the `arith` library functions. Numbers processed by this library are represented by variable length vectors containing the sign, the exponent and fractional part. Typically, a number is passed to the functions in this library as a pair (N, upb) where N is the vector and `upb` is its upperbound. For such a number the following holds:

N!0 = TRUE if the number is negative.
 = FALSE if the number is greater than or equal to 0.
N!1 is the exponent e , ie the value of the number is
 fractional_part $\times 10000^e$.
 The exponent may be positive or negative.
N!2 to N!upb hold the fractional part with an assumed decimal point
 to the left of the first digit in N!2. The digits
 are in the range 0 to 9999.

If N is in standard form then either N!2 is non zero or all its elements are zero.
 The fractional part contains digits of radix 10000 so the approximate precision
 of the number is slightly less than $4 \times (\text{upb} - 2)$ decimal digits. Rounding errors
 cause some loss of precision and also N!2 may contain fewer the 4 significant
 decimal digits.

After some comments, `arith.b` starts with the definition of `str2num` as follows.

```

LET str2num(s, n1, upb1) = VALOF
{ LET p = 0      // Count of decimal digits not including
                // leading zeroes
  LET fp = -1 // Count of decimal digits after the decimal point, if any.
  LET pos = 2 // Position of next radix digit
  LET dig = 0 // To hold the next radix digit
  LET dexp = ?
  LET e = 0    // For the exponent specified by En
  n1!0 := -2   // No sign yet
  FOR i = 1 TO upb1 DO n1!i := 0

  FOR i = 1 TO s%0 DO
  { LET ch = s%i

    SWITCHON ch INTO
    { DEFAULT: RESULTIS FALSE

      CASE ' ': LOOP // Ignore spaces

      CASE '-': UNLESS n1!0=-2 RESULTIS FALSE
                n1!0 := TRUE
                LOOP

      CASE '+': UNLESS n1!0=-2 RESULTIS FALSE
                n1!0 := FALSE
                LOOP

      CASE '.': IF fp>=0 RESULTIS FALSE // Invalid decimal point
                fp := 0 // Count of digits after the decimal point.

```

```

        LOOP
CASE 'E':
CASE 'e': { // Read a possibly signed exponent leaving
           // its value in e.
           LET nege = -2
           FOR j = i+1 TO s%0 DO
           { ch := s%j
             SWITCHON ch INTO
             { DEFAULT: RESULTIS FALSE

              CASE ' ': LOOP // Ignore spaces

              CASE '-': UNLESS nege=-2 RESULTIS FALSE
                        nege := TRUE
                        LOOP

              CASE '+': UNLESS nege=-2 RESULTIS FALSE
                        nege := FALSE
                        LOOP

              CASE '0':CASE '1':CASE '2':CASE '3':CASE '4':
              CASE '5':CASE '6':CASE '7':CASE '8':CASE '9':
                IF nege=-2 DO nege := FALSE
                e := 10*e + ch - '0'
                LOOP
            }
          }
          IF nege DO e := -e
          BREAK
        }

CASE '0': IF p=0 DO
          { // No significant decimal digits yet
            // If sign unset make it positive
            IF n1!0=-2 DO n1!0 := FALSE
            IF fp>=0 DO fp := fp+1
            LOOP
          }

CASE '1':CASE '2':CASE '3':CASE '4':
CASE '5':CASE '6':CASE '7':CASE '8':CASE '9':
          { // A significant digit
            // If sign unset make it positive
            IF n1!0=-2 DO n1!0 := FALSE
            p := p+1 // Increment count of significant digits

```

```

        IF fp>=0 DO fp := fp+1 // Count of fractional digit
        dig := 10*dig + ch - '0'
        IF p MOD 4 = 0 DO
        { // Just completed a radix digit
          // Store it digit, if possible
          IF pos<=upb1 DO n1!pos := dig
          dig := 0
          pos := pos+1
        }
        LOOP
      }
    }

    IF p=0 DO
    { // No significant digits, so the result is zero.
      setzero(n1,upb1)
      RESULTIS TRUE
    }

    // Place a decimal point here if not already present.
    IF fp<0 DO fp := 0

    // Pad last radix digit by adding fractional decimal zeroes.

    UNTIL p MOD 4 = 0 DO
    { dig := dig * 10
      p := p+1
      IF fp >= 0 DO fp := fp+1
    }

    // Store the last digit, if room.
    IF pos<= upb1 DO n1!pos := dig

    // n1!2 contains 4 decimal digits including the padding zeroes.

    dexp := p-fp // Decimal exponent

    // p is the number of decimal digits including padding.
    // p is a multiple of 4.
    // fp is the number of fractional decimal digits including padding.

    // We require dexp to be a multiple of 4, so
    // until dexp is a multiple of 4, increment dexp and divide
    // the fractional value by 10.

```

```

UNTIL dexp MOD 4 = 0 DO
{ divbyk(10, n1, upb1)
  dexp:= dexp+1
}

// The decimal exponent dexp is now a multiple of 4.

n1!1 := dexp/4 // Set the radix exponent.

// Now add in the En exponent
n1!1 := n1!1 + e

//checknum(n1, upb1)
RESULTIS TRUE
}

```

This function converts a string representing a high precision number into its vector form. The number starts with an optional sign followed by decimal digits and at most one decimal point. An explicit exponent can then be given consisting of E or e followed by a possibly signed integer. The exponent represents a power of 10000. Spaces are ignored, so for instance: `str2num("-12.3456 789 E3", N,5)` will set the elements of N to:

```
[TRUE, 4, 0012, 3456 7890, 0000]
```

A vector representation of a number in the range -9999 to +9999 may be set using the function `settok` defined as follows.

```

AND settok(k, n1, upb1) = VALOF
{ // k must be in range -9999 to +9999
  // Return TRUE is k is in range
  setzero(n1, upb1)
  IF k=0 RESULTIS TRUE
  IF k<0 DO n1!0, k := TRUE, -k
  IF k>=10000 RESULTIS FALSE
  n1!1, n1!2 := 1, k
  RESULTIS TRUE
}

```

The integer part of a number can be found using `integerpart` defined below. This function requires the number to be in standard form and in the range -9999_9999 to +9999_9999. If the integer part is out of range the result is either +1_0000_0000 or -1_0000_0000.

```
AND integerpart(n1, upb1) = VALOF
```

```

{ LET e = n1!1
  LET x = n1!2 * 10000
  IF upb1>=3 DO x := x + n1!3
  IF e > 2 DO x := 1_0000_0000
  IF n1!0 DO x := -x
  IF e <= 0 RESULTIS 0
  IF e = 1 RESULTIS x / 10000
  RESULTIS x
}

```

The following function rounds its argument to the nearest integer, returning a value representing the first 8 decimal digits after the decimal point before rounding takes place.

```

AND roundtoint(n1,upb1) = VALOF
{ LET e = n1!1 // The exponent
  LET frac = 0

  IF e > 0 DO
  { // The integer part is non zero

    // e > 0
    LET p = e+2 // Position of the first fractional radix digit
    LET carry = p<upb1 & n1!p>=5000 -> 1, 0
    IF p <= upb1 DO frac := n1!p * 10000 // Fractional digits 1 to 4
    IF p < upb1 DO frac := frac + n1!(p+1) // Fractional digits 5 to 8

    FOR i = p TO upb1 DO n1!i := 0
    IF carry DO addcarry(n1,p-1)

    //checknum(n1,upb1)
    RESULTIS frac
  }

  // The unrounded integer part is zero, so the rounded
  // integer part is zero or 1.
  // e <= 0
  IF e = 0 DO frac := n1!2*10000 + n1!3 // 8 fractional digits
  IF e=-1 DO frac := n1!2 // 4 fractional digits

  TEST e=0 & frac >= 50000000
  THEN settok(1, n1,upb1) // n1 was in range 0.5 to 0.99999999
  ELSE setzero(n1,upb1) // n1 was in range 0.0 to 0.49999999

  //checknum(n1,upb1)
}

```

```

    RESULTIS frac
}

```

The next function outputs a character representation of the high precision number it is given.

```

AND prnum(n, upb) BE
{ // Output a number n of size upb, followed by a newline().
  writef("%c0.", n!0->'-', '+')
  FOR i = 2 TO upb DO
  { writef("%z4 ", n!i)
    IF (i-2) MOD 10 = 9 DO writef("*n ")
  }
  IF n!1 DO writef("E%n", n!1)
  newline()
}

```

For example, if N points to: [TRUE, 4, 0012, 3456 7890, 0000], prnum(N,5) outputs: -0.0012 3456 7890 0000 E4.

The function defined below compares the magnitude of two high precision numbers returning -1, 0 or +1 depending on whether the absolute value of the first number is less, equal, or greater than the absolute value of the second.

```

AND numcmpu(n1,upb1, n2,upb2) = VALOF
{ // Return 1 if abs n1 > abs n2
  // Return 0 if abs n1 = abs n2
  // Return -1 if abs n1 < abs n2
  // n1 and n2 are assumed to be in standard form.
  LET upb = upb1<=upb2 -> upb1, upb2
  // upb is the smaller upper bound

  // Deal with the cases when n1 or n2 is zero.
  IF n1!2=0 DO
  { IF n2!2=0 RESULTIS 0 // n1= 0 n2= 0
    RESULTIS -1 // n1= 0 n2~=0
  }

  IF n2!2=0 RESULTIS 1 // n1~=0 n2= 0

  // Neither n1 nor n2 is zero
  FOR i = 1 TO upb DO
  { // Compare the exponents and digit os n1 and n2.
    LET a, b = n1!i, n2!i
    IF a > b RESULTIS 1 // n1 > n2
    IF a < b RESULTIS -1 // n1 < n2
  }
}

```



```

}

IF upb1=upb2 RESULTIS 0

TEST upb1>upb
THEN FOR i = upb+1 TO upb1 IF n1!i RESULTIS 1
ELSE FOR i = upb+1 TO upb2 IF n2!i RESULTIS -1

RESULTIS 0
}

```

The function defined below compares two standardized signed numbers, returning -1, 0 or +1.

```

AND numcmp(n1,upb1, n2,upb2) = VALOF
{ // Return 1 if n1 > n2
  // Return 0 if n1 = n2
  // Return -1 if n1 < n2
  // n1 and n2 are assumed to be in standard form.
  IF n1!0 DO
  { IF n2!0 RESULTIS - numcmppu(n1,upb1, n2,upb2) // n1< 0, n2< 0
    RESULTIS -1 // n1< 0, n2>=0
  }

  IF n2!0 RESULTIS 1 // n1>=0, n2< 0

  RESULTIS numcmppu(n1,upb1, n2,upb2) // n1>=0 n2>=0
}

```

The next function standardizes n1 then sets n2 = -n1.

```

AND neg(n1,upb1) = VALOF
{ // Standardize n1 and the set n1 = -n1
  standardize(n1,upb1)
  IF n1!2 DO n1!0 := ~ n1!0
  RESULTIS TRUE
}

```

The function `iszero` defined below returns TRUE if n1 is zero. If n1 is known to be in standard form, it is more efficient just to test n1!2.

```

AND iszero(n1,upb1) = VALOF
{ // n1 is zero if all the fraction digits are zero
  FOR i = 2 TO upb1 UNLESS n1!i=0 RESULTIS FALSE
  RESULTIS TRUE
}

```

The next function sets n_3 to $ABS\ n_1 + ABS\ n_2$, assuming n_1 and n_2 are in standard form. The result is rounded.

```

AND addu(n1,upb1, n2,upb2, n3,upb3) = VALOF
{ // Set n3 to abs n1 + abs n2 rounded
  // n1 and n2 are assumed to be in standard form.
  LET carry = 0
  LET t1,u1 = n1,upb1 // To hold the number with the larger exponent
  LET t2,u2 = n2,upb2 // To hold the number with the smaller exponent
  LET offset = ?
  LET p, q = ?, ?
  LET tmp = VEC numupb

  //checknum(n1,upb1)
  //checknum(n2,upb2)

  IF n1!2=0 RESULTIS copyu(n2,upb2, n3,upb3)
  IF n2!2=0 RESULTIS copyu(n1,upb1, n3,upb3)

  // Neither n1 nor n2 are zero.

  IF n1!1<n2!1 DO // Compare their exponents
  { t1,u1 := n2,upb2
    t2,u2 := n1,upb1
  }

  // t1!1 >= t2!1    So t1 has the larger exponent

  offset := t1!1-t2!1
  // offset is >= 0
  // It is the amount t2 must be shifted before adding to t1

  p := u2          // Position of the last digit of t2
  q := u2+offset  // Position in tmp of where to add it.

  IF q > numupb DO
  { // Reduce both p and q so the q=numupb
    p := p - (u2+offset-numupb)
    q := numupb
  }

  // Form the sum in tmp
  copyu(t1,u1, tmp,numupb)

  // Add t2 suitably shifted into tmp
  WHILE p >= 2 DO

```

```

{ LET x = tmp!q + t2!p + carry
  tmp!q := x MOD 10000
  carry := x / 10000
  p, q := p-1, q-1
}

// There are no more digits of t2, but the may still be a carry
// to deal with
WHILE carry & q >= 2 DO
{ LET x = tmp!q + carry
  tmp!q := x MOD 10000
  carry := x / 10000
  q := q-1
}

// If there is a carry out of the senior digit, tmp must be
// shifted right and the exponent corrected.
IF carry DO
{ // Shift the radix digits to the right by one position.
  FOR i = numupb-1 TO 2 BY -1 DO tmp!(i+1) := tmp!i
  tmp!2 := carry
  tmp!1 := tmp!1 + 1 // Adjust the exponent
}

copy(tmp,numupb, n3,upb3) // Set n3 = tmp rounded

//checknum(n3,upb3)
RESULTIS TRUE
}

```

The next function sets `n3` to `ABS n1 - ABS n2` assuming the result is greater than or equal to zero. Both `n1` and `n2` are assumed to be in standard form. The result is rounded.

```

AND subu(n1,upb1, n2,upb2, n3,upb3) = VALOF
{ LET borrow = 0
  LET t1,u1 = n1,upb1 // To hold the number with the larger exponent
  LET t2,u2 = n2,upb2 // To hold the number with the smaller exponent
  LET offset = ?
  LET p, q = ?, ?
  LET tmp = VEC numupb

  //checknum(n1,upb1)
  //checknum(n2,upb2)

```

```

IF n2!2=0 RESULTIS copyu(n1,upb1, n3,upb3)

IF n1!2=0 DO
{ // Since abs n1 >= abs n2 and n1=0 the so does n2.
  setzero(n3,upb3)
  RESULTIS TRUE
}

// Neither n1 nor n2 are zero.

// Since abs n1 >= abs n2 and they are both non zero,
// the exponent of n1 must be >= exponent of n2

// is n1!1 >= n2!1      So t1 has the larger exponent

offset := n1!1-n2!1
// offset is >= 0
// It is the amount n2 must be shifted before adding to n1

p := upb2          // Position of the last digit of n2
q := upb2+offset  // Position in tmp of where to subtract it.

IF q > numupb DO
{ // Reduce both p and q so the q=numupb
  p := p - (u2+offset-numupb)
  q := numupb
}

// Form the difference in tmp
copyu(t1,u1, tmp,numupb)

// Subtract n2 suitably shifted from tmp
WHILE p >= 2 DO
{ LET x = tmp!q - borrow - t2!p
  borrow := 0
  IF x < 0 DO borrow, x := 1, x + 10000
  tmp!q := x
  p, q := p-1, q-1
}

// There are no more digits of n2, but the may still be a borrow
// to deal with
WHILE borrow & q >= 2 DO
{ LET x = tmp!q - borrow
  borrow := 0

```

```

    IF x < 0 DO borrow, x := 1, x + 10000
    tmp!q := x
    q := q-1
}

IF borrow DO
{ // There was a borrow out of the senior radix digit.
  // This is a system error since abs n1 is >= abs n2.
  writef("SYSTEM ERROR: in subu*n")
  abort(999)
  RESULTIS FALSE
}

standardize(tmp,numupb)

copy(tmp,numupb, n3,upb3) // Set n3 = tmp rounded

//checknum(n3,upb3)
RESULTIS TRUE
}

```

The next function sets its argument to 0.0.

```
AND setzero(n1, upb1) BE FOR i = 0 TO upb1 DO n1!i := 0
```

The next function sets $n3$ to $n1 + n2$ using signed arithmetic. Both $n1$ and $n2$ are assumed to be in standard form. The result is rounded.

```

AND add(n1,upb1, n2,upb2, n3,upb3) = VALOF
{ // Add signed numbers n1 and n2 placing the rounded result in n3

  LET rc = ?
  LET t = VEC numupb

  //checknum(n1,upb1)
  //checknum(n2,upb2)

  IF n1!2=0 DO
  { copy(n2,upb2, n3,upb3) // n1 is zero
    RESULTIS TRUE
  }

  IF n2!2=0 DO
  { copy(n1,upb1, n3,upb3) // n2 is zero
    RESULTIS TRUE
  }
}

```

```

}

// Neither n1 nor n2 are zero

IF n1!0=n2!0 DO
{ // eg +5 + +3 => + (5+3)
  // eg -3 + -5 => - (5+3)
  // So add the absolute values and then set the sign
  rc := addu(n1,upb1, n2,upb2, n3,upb3)
  UNLESS n3!2=0 DO n3!0 := n1!0
  RESULTIS rc
}

// The signs are different
rc := numcmptu(n1,upb1, n2,upb2)

IF rc=0 RESULTIS setzero(n3,upb3)

TEST n1!0
THEN TEST rc>0
  THEN { // eg -5 + +3 => - (5-3)
    rc := subu(n1,upb1, n2,upb2, n3,upb3)
    UNLESS n3!2=0 DO n3!0 := TRUE
    RESULTIS rc
  }
  ELSE { // eg -3 + +5 => + (5-3)
    rc := subu(n2,upb2, n1,upb1, n3,upb3)
    n3!0 := FALSE
    RESULTIS rc
  }
ELSE TEST rc<0
  THEN { // eg +5 + -3 => + (5-3)
    rc := subu(n1,upb1, n2,upb2, n3,upb3)
    n3!0 := FALSE
    RESULTIS rc
  }
  ELSE { // eg +3 + -5 => - (5-3)
    rc := subu(n2,upb2, n1,upb1, n3,upb3)
    UNLESS n3!2=0 DO n3!0 := TRUE
    RESULTIS rc
  }
}

```

The next function sets $n3$ to $n1 - n2$ using signed arithmetic. Both $n1$ and $n2$ are assumed to be in standard form. The result is rounded.

```

AND sub(n1,upb1, n2,upb2, n3,upb3) = VALOF
{ // Subtract n2 from n1 using signed arithmetic placing
  // the rounded result in n3.
  LET rc = ?
  LET n2sign = n2!0

  //checknum(n1,upb1)
  //checknum(n2,upb2)

  IF n2!2=0 DO
  { copy(n1,upb1, n3,upb3) // n2 is zero
    RESULTIS TRUE
  }

  // n2 is non zero
  n2!0 := ~ n2!0 // Negate n2

  rc := add(n1,upb1, n2,upb2, n3,upb3)
  //checknum(n3,upb3)
  n2!0 := n2sign // Restore the sign of n2

  // No need to call checknum since add has already done so.
  standardize(n3,upb3)

  //checknum(n3,upb3)
  RESULTIS rc
}

```

The next function sets $n3$ to $n1 * n2$ using signed arithmetic. Both $n1$ and $n2$ are assumed to be in standard form. The result is rounded.

It does this by clearing an accumulator $t1$ and the successively adding the product of radix digits from $n1$ and $n2$ into appropriate positions in $t1$. These products are typically larger than 9999 and so a carry operation is performed occasionally to ensure all fraction digits in $t1$ are in the range 0 to 9999. Notice that if the exponents of $n1$ and $n2$ are both zero then the result will have exponent zero. Unless the result is zero the exponent of the result will be the sum of the exponents of the two operands. Having computed the product in $t1$, this result is copied to $n3$, rounding it if $upb3$ is smaller the $numupb$.

```

AND mul(n1,upb1, n2,upb2, n3,upb3) = VALOF
{ LET sign = n1!0 XOR n2!0 // Set the sign of the result
  LET e1 = n1!1
  LET e2 = n2!1
  LET exponent = e1 + e2 // Initial exponent
  LET carry = ?

```

```

LET t1 = VEC numupb

IF iszero(n1,upb1) | iszero(n2,upb2) DO
{ setzero(n3,upb3)
  RESULTIS TRUE
}

setzero(t1,numupb)

// Neither n1 nor n2 are zero.

// Set the exponents of n1 and n2 to zero
n1!1, n2!1 := 0, 0
// Form the product n1*n2 in t1.
// Both n1 and n2 are less than 1.0 so the product will be less than 1.0.
FOR i = 2 TO upb1 DO
{ // Take each digit of n1
  LET n1i = n1!i
  IF n1i DO
  { LET p, x = ?, ?
    LET jlim = numupb+1-i
    IF jlim > upb2 DO jlim := upb2
    // j is in the range 2 to upb2, but the destination
    // position i+j-1 must be <= numupb, so
    // i+j-1 <= numupb  ie j <= numupb+1-i
    // j must also be <= upb2
    FOR j = jlim TO 2 BY -1 DO
    { p := i + j - 1 // The destination position
      t1!p := t1!p + n1i * n2!j
    }

    carry := 0
    FOR j = numupb TO 1 BY -1 DO
    { LET x = t1!j + carry
      t1!j := x MOD 10000
      carry := x / 10000
    }
  }
}

t1!0 := sign
t1!1 := t1!1 + exponent
standardize(t1,numupb)
copy(t1,numupb, n3,upb3)

// Restore the exponents of n1 and n2

```



```

n1!1, n2!1 := e1, e2

//checknum(n3,upb3)
RESULTIS TRUE
}

```

The next function set $n1 = k * n1$ where k is in the range -9999 to $=9999$.

```

AND mulbyk(k, n1,upb1) = VALOF
{ LET sign = n1!0
  LET carry = 0

  standardize(n1,upb1)

  IF n1!2=0 RESULTIS TRUE

  IF k=0 DO
  { setzero(n1,upb1)
    RESULTIS TRUE
  }

  IF k<0 DO n1!0, k := ~n1!0, -k

  // The result sign is correct and k is non zero.
  // Multiply digits from the least significant end
  // dealing with carry.
  FOR i = upb1 TO 2 BY -1 DO
  { LET x = n1!i * k + carry
    n1!i := x MOD 10000
    carry := x / 10000
  }

  IF carry DO
  { // Shift the fractional part to the right one place
    // and adjust the exponent.
    LET lsdig = n1!upb1
    FOR i = upb1-1 TO 2 BY -1 DO n1!(i+1) := n1!i
    n1!1 := n1!1 + 1
    n1!2 := carry
    IF lsdig >= 5000 DO addcarry(n1,upb1)
  }

  //checknum(n1,upb1)
  RESULTIS TRUE
}

```

The next function sets $n2 = 1/n1$. It uses a Newton-Raphson iteration based on finding the value of x for which $f(x) = (1/x-a) = 0$. The slope (or differential) of this function at x is $-1/x^2$ and this leads to the iteration: $x_{n+1} = x_n + x_n(1 - a \times x_n)$. This iteration require a good initial guess since it is easy to choose a value that causes the iteration to diverge. Luckily we can use ordinary single length division to help provide a good initial guess using the first 8 significant decimal digits of $n1$. The implementation is otherwise quite straightforward. If $upb2 < numupb$ the result is rounded.

```

AND inv(n1,upb1, n2,upb2) = VALOF
{ // Standardize n1 if necessary, then if n1 is zero return FALSE,
  // otherwise standardize set n2 = 1/n1.
  // upb1 is assumed to be > 2.
  LET one = TABLE FALSE, 1, 0001 // The number +1.0
  LET sign = n1!0 // The sign of n1
  LET e = ? // To hold the exponent of n1
  LET elim = -(numupb - 2 - numupb/4)

  LET t1 = VEC numupb
  AND t2 = VEC numupb
  AND t3 = VEC numupb
  AND t4 = VEC numupb

  //checknum(n1,upb1)

  IF n1!2=0 RESULTIS FALSE // Cannot take the inverse of zero.

  IF numcmp(one,2, n1,upb1)=0 DO
  { settok(1, n2,upb2) // The inverse of 1.0 is 1.0.
    RESULTIS TRUE
  }

  e := n1!1
  n1!0, n1!1 := FALSE, 0 // Set n1 to be in the range +0.0001 to +1.0000

  // Select initial guess
  { LET w = n1!2 * 1_0000 + n1!3
    // 10000 <= w <= 99999999
    LET a = muldiv(9999_9999, 1_0000, w)
    setzero(t1,numupb)
    t1!0 := FALSE // Set positive
    t1!1 := 1 // Set the exponent
    t1!2 := a / 1_0000 // and two radix digits
    t1!3 := a MOD 1_0000 // of the initial guess.
  }
}

```

```

    { // Start of Newton-Raphson loop

again:
    mul(t1,numupb, n1,upb1, t2,numupb) // Set t2 = t1*n1
    sub(one,2, t2,numupb, t3,numupb) // Set t3 := 1 - t1*n1
    mul(t1,numupb, t3,numupb, t2,numupb)
    add(t1,numupb, t2,numupb, t3,numupb)
    IF t3!1>100 DO
    { // The iteration for 1/n1 has diverged
      newline()
      writef("The iteration for 1/n1 has diverged*n")
      writef("n1= "); prnum(n1,upb1)
      abort(999)
    }
    sub(t3,numupb, t1,numupb, t2,numupb)
    UNLESS iszero(t2,numupb) DO
    { IF t2!1 > elim DO
      { copy(t3,numupb, t1,numupb)
        GOTO again
      }
    }
  }
}

t3!0, t3!1 := sign, 1-e // Set the sign and exponent of the result
copy(t3,numupb, n2,upb2)

n1!0, n1!1 := sign, e // Restore the sign and exponent of n1

//checknum(n2,upb2)
RESULTIS TRUE
}

```

The next function divides $n1$ by a single radix digit k leaving the result in $n1$. It does this using, so called, short division which is quite straightforward to implement. The divisor can be negative.

```

AND divbyk(k, n1,upb1) = VALOF
{ LET sign, carry = ?, 0
  LET e = n1!1

  standardize(n1,upb1)

  IF k=0 RESULTIS FALSE
  IF n1!2=0 RESULTIS TRUE

```

```

sign := n1!0

IF k<0 DO sign, k := ~sign, -k

FOR i = 1 TO upb1-1 DO
{ LET x = carry*10000 + n1!(i+1)
  n1!i := x / k
  carry := x MOD k
}
n1!upb1 := carry

TEST n1!1
THEN FOR i = upb1-1 TO 1 BY -1 DO n1!(i+1) := n1!i
ELSE e := e-1

n1!0 := sign
n1!1 := e

//checknum(n1,upb1)
RESULTIS TRUE
}

```

The next function sets $n3 = n1 / n2$ using signed arithmetic. After dealing with the special case of $n1=0$, it does this by first calculating the inverse of $n2$ and then multiplying it by $n1$. This method is used since there is a good Newton-Raphson iteration to calculate an inverse but not for a general division.

```

AND div(n1,upb1, n2,upb2, n3,upb3) = VALOF
{ LET t1 = VEC numupb
  LET t2 = VEC numupb

  //checknum(n1,upb1)
  //checknum(n2,upb2)

  IF n1!2=0 DO
  { setzero(n3,upb3) // If n1 is zero the result is zero
    RESULTIS TRUE
  }

  IF n2!2=0 RESULTIS FALSE // Cannot divide by zero

  inv(n2,upb2, t1,numupb) // t1 = 1/n2
  mul(n1,upb1, t1,numupb, t2,numupb) // t2 = n1 * 1/n2
  copy(t2,numupb, n3,upb3) // n3 = t2 rounded
}

```

```

//checknum(n3,upb3)
RESULTIS TRUE
}

```

The next function calculates the square root of **n1** leaving the result in **n2**. It uses a Newton-Raphson iteration based on finding the value of x that causes $f(x) = x^2 - a$ to be zero. The differential (the slope at x) of this function $2x$ and this leads to the iteration: $x_{n+1} = (x_n + a/x_n)/2$. After dealing with the simple special case of **n1=0**, the function remembers the exponent of **n1** in **e** then sets **n1!1** to zero causing **n1** to be in range 0.0001 to 0.9999. A reasonable initial guess is then chosen based on the first 8 decimal digits of **n1** and the iteration started. Once the iteration is complete, the exponent of the result is set. As can be seen special care is needed if the original exponent was an odd number. The final call of **copy** rounds the result, if necessary.

```

AND sqrt(n1,upb1, n2,upb2) = VALOF
{ // Set n2 to the square root of n1.
  LET rc, prevrc = ?, -2
  LET e = ?
  LET elim = -(numupb - 2 - numupb/4)
  LET t1 = VEC numupb
  AND t2 = VEC numupb
  AND t3 = VEC numupb

  setzero(n2,upb2)

  IF iszero(n1) RESULTIS TRUE // sqrt(0) = 0

  standardize(n1,upb1)
  // n1!2 will certainly be non zero

  IF n1!0 RESULTIS FALSE // n1 must be positive

  e := n1!1 // Remember the exponent of n1 in e
  n1!1 := 0 // Cause n1 to be in range 0001 to 9999

  // n1 is greater than zero

  { // Choose a reasonable initial guess
    LET a = n1!2 * 10000 + n1!3 // 0001 <= a <= 9999_9999
    LET guess = 100_0000

    UNTIL muldiv(guess, guess, 1_0000_0000) >= a DO
      guess := guess + guess
  }
}

```

```

    guess := (guess + muldiv(a, 1_0000_0000, guess))>>1
    guess := (guess + muldiv(a, 1_0000_0000, guess))>>1
    guess := (guess + muldiv(a, 1_0000_0000, guess))>>1
    guess := (guess + muldiv(a, 1_0000_0000, guess))>>1

    // Place the initial guess in t1
    setzero(t1,numupb)
    t1!2, t1!3 := guess/10000, guess MOD 10000
}

setzero(t2,numupb)
setzero(t3,numupb)

{ // Start of Newton=Raphson sqrt loop
again:
    div(n1,upb1, t1,numupb, t2,numupb) // t2 = n1/t1
    add(t1,numupb, t2,numupb, t3,numupb) // t3 = t1 + n1/t1
    divbyk(2, t3,numupb) // Set t3 := (t1 + n1/t1)/2

    sub(t3,numupb, t1,numupb, t2,numupb)
    UNLESS iszero(t2,numupb) DO
    { IF t3!1 + elim < t2!1 DO
        { copy(t3,numupb, t1,numupb)
          GOTO again
        }
    }
}

t3!1 := e>=0 -> (e+1)/2, (e-1)/2
n1!1 := e // Restore the exponent of n1
UNLESS (e&1)=0 TEST e>0 THEN divbyk(100, t3,numupb)
                        ELSE mulbyk(100, t3,numupb)

copy(t3,numupb, n2,upb2)

//checknum(n2,upb2)
RESULTIS TRUE
}

```

The next function set $n2 = n1$ rounding if necessary.

```

AND copy(n1,upb1, n2,upb2) = VALOF
{ LET p = upb1
  IF p > upb2 DO p := upb2

```

```

FOR i = 0 TO p DO n2!i := n1!i
FOR i = p+1 TO upb2 DO n2!i := 0 // Pad with zeroes

IF p>upb2 & n1!(upb2+1) > 5000 DO addcarry(n2,p)

IF n2!2=0 RESULTIS standardize(n2,upb2)
//checknum(n2,upb2)
RESULTIS TRUE
}

```

The next function sets $n2 = \text{ABS } n1$, rounding if necessary.

```

AND copyu(n1,upb1, n2,upb2) = VALOF
{ LET p = upb1
  IF p > upb2 DO p := upb2

  FOR i = 1 TO p DO n2!i := n1!i
  FOR i = p+1 TO upb2 DO n2!i := 0 // Pad with zeroes

  IF p>upb2 & n1!(upb2+1) > 5000 DO addcarry(n2,p)

  n2!0 := FALSE // Set the result to be positive
  IF n2!2=0 RESULTIS standardize(n2,upb2)
  //checknum(n2,upb2)
  RESULTIS TRUE
}

```

The next function is mainly used internally in the `arith` library to help implement rounding. It adds one at position p of the fraction digits of $n1$. Note that if p is less than the upperbound of $n1$, the radix digits from position $p+1$ to the end are not changed.

```

AND addcarry(n1,p) = VALOF
{ FOR i = p TO 2 BY -1 DO
  { LET x = n1!i
    UNLESS x = 9999 DO { n1!i := x+1; RESULTIS TRUE }
    n1!i := 0
  }
}

// There is a carry out of the senior digit position.
// This can only happen if 1 was added to 9999 9999 .. 9999
// so n1!2 to n1!upb1 are all zero.
n1!2 := 0001
n1!1 := n1!1 + 1 // Correct the exponent

```

```

//checknum(n1,p)
RESULTIS TRUE
}

```

The next function standardizes the high precision number it is given. It either sets `n1` to zero or ensures that `n1!2` is non zero, shifting the fraction digits and adjusting the exponent, if necessary.

```

AND standardize(n1,upb1) = VALOF
{ LET p = 2
  UNTIL p>upb1 | n1!p DO p := p+1

  IF p>upb1 DO
  { // The number is zero if every radix digit is zero.
    n1!0, n1!1 := FALSE, 0 // Other elements are already zero.
    RESULTIS TRUE
  }

  UNLESS p=2 DO
  { // Shift the fractional part to the left
    // and adjust the exponent.
    FOR i = p TO upb1 DO n1!(2+i-p) := n1!i
    FOR i = upb1-p+1 TO upb1 DO n1!i := 0
    n1!1 := n1!1 - p + 2 // Correct the exponent
  }

  RESULTIS TRUE
}

```

The next function sets `d` to the radius of a sphere centred at the origin that has point `p` on its surface. If `p` represents the point (x, y, z) then `d` is given the value representing $\sqrt{x^2 + y^2 + z^2}$.

```

AND radius(p,upb1, d,upb2) = VALOF
{ LET t1 = VEC numupb
  LET t2 = VEC numupb
  LET t3 = VEC numupb
  LET t4 = VEC numupb
  LET t5 = VEC numupb

  UNLESS mul(p!0,upb1, p!0,upb1, t1,numupb) RESULTIS FALSE
  UNLESS mul(p!1,upb1, p!1,upb1, t2,numupb) RESULTIS FALSE
  UNLESS mul(p!2,upb1, p!2,upb1, t3,numupb) RESULTIS FALSE
  UNLESS add(t1,numupb, t2,numupb, t4,numupb) RESULTIS FALSE

```



```

UNLESS add(t3,numupb, t4,numupb, t5,numupb) RESULTIS FALSE
UNLESS sqrt(t5,numupb, d,upb2) RESULTIS FALSE

RESULTIS TRUE
}

```

The function `inprod`, defined below, computes the inner product of two 3D vectors `dir1` and `dir2` leaving the result in `n3`. The components of `dir1` and `dir2` have upperbounds `upb1` and `upb2`, respectively. If `dir1` and `dir2` represent (a, b, c) and (x, y, z) , respectively, the result placed in `n3` represents $ax + by + cz$. As will be shown on page 602, if (a, b, c) and (x, y, z) are direction cosines, the result is the cosine of the angle between them.

```

AND inprod(dir1,upb1, dir2,upb2, n3,upb3) = VALOF
{ // dir1 and dir2 are 3D vectors.
  // ie dir1 -> [dx1,dy1,dz1] and dir2 -> [dx2,dy2,dz2] where
  // upb1 is the upperbounds of dx1, dy1 and dz1
  // upb2 is the upperbounds of dx2, dy2 and dz2
  // n3 is set to the dx1*dx2+dy1*dy2*dz1*dz2
  // If dir1 and dir2 represent direction cosines, n3 will be the
  // cosine of the angle between them.
  LET t1 = VEC numupb
  AND t2 = VEC numupb
  AND t3 = VEC numupb
  AND t4 = VEC numupb

  mul(dir1!0,upb1, dir2!0,upb2, t1,numupb)
  mul(dir1!1,upb1, dir2!1,upb2, t2,numupb)
  mul(dir1!2,upb1, dir2!2,upb2, t3,numupb)
  add(t1,numupb, t2,numupb, t4,numupb)
  add(t3,numupb, t4,numupb, n3,upb3)
  RESULTIS TRUE
}

```

The function `crossprod`, defined below, calculates the cross product of two 3D vectors `dir1` and `dir2` leaving the result in `dir3`. The upperbounds of the components of these three vectors are `upb1`, `upb2` and `upb3`, respectively.

If `dir1` and `dir2` represent (a, b, c) and (x, y, z) , respectively, then the components of `dir3` are set to represent $(bz - cy, cx - az, ay - bx)$. The direction of `dir3` will be orthogonal to the plane specified by `dir1` and `dir2`, and its length will be the product of the lengths of `dir1` and `dir2` multiplied by the sine of the angle between them. As a special case, if `dir1` = $(1, 0, 0)$ and `dir2` = $(0, 1, 0)$, then `dir3` will represent $(0, 0, 1)$.

```

AND crossprod(dir1,upb1, dir2,upb2, dir3,upb3) = VALOF
{ LET t1 = VEC numupb
  AND t2 = VEC numupb

  mul(dir1!1,upb1, dir2!2,upb2, t1,numupb) // t1 = bz
  mul(dir1!2,upb1, dir2!1,upb2, t2,numupb) // t2 = cy, cx-az and ay-bx,
  sub(t1,numupb, t2,numupb, dir3!0,upb3) // dir3!0 = bz-cy

  mul(dir1!2,upb1, dir2!0,upb2, t1,numupb) // t1 = cx
  mul(dir1!1,upb1, dir2!2,upb2, t2,numupb) // t2 = az
  sub(t1,numupb, t2,numupb, dir3!1,upb3) // dir3!0 = cx-az

  mul(dir1!0,upb1, dir2!1,upb2, t1,numupb) // t1 = ay
  mul(dir1!1,upb1, dir2!2,upb2, t2,numupb) // t2 = bx
  sub(t1,numupb, t2,numupb, dir3!2,upb3) // dir3!0 = ay-bx

  RESULTIS TRUE
}

```

The function `normalize`, defined below, converts an arbitrary 3D vector to one of unit length pointing in the same direction. Its implementation is straightforward.

```

AND normalize(dir, upb) = VALOF
{ // This function causes a 3D vector dir to be scaled to make it
  // unit length. dir!0, dir!1 and dir!2 are the three components
  // of the vector and each have uprbound upb. It is implemented
  // dividing these numbers by radius(dir!0,upb, dir!1,upb, dir!2,upb)
  // The resulting values are often call direction cosines.
  LET d = VEC numupb
  LET t = VEC numupb

  UNLESS radius(dir,upb, d,numupb) RESULTIS FALSE

  IF iszero(d,numupb) DO
  { settok(1, dir!0,upb)
    setzero(dir!1,upb)
    setzero(dir!2,upb)
    //writef("Set dir to (1,0,0) since dir was too small*n")
    RESULTIS TRUE
  }

  UNLESS div(dir!0,upb, d,numupb, t,numupb) RESULTIS FALSE
  copy(t,numupb, dir!0,upb)
}

```

```

UNLESS div(dir!1,upb, d,numupb, t,numupb) RESULTIS FALSE
copy(t,numupb, dir!1,upb)

UNLESS div(dir!2,upb, d,numupb, t,numupb) RESULTIS FALSE
copy(t,numupb, dir!2,upb)

RESULTIS TRUE
}

```

The function `exptok`, defined below, computes $n1^k$ by the reasonably efficient method described on page 65.

```

AND exptok(k, n1,upb1, n2,upb2) BE
{ // Set n2 to  $n1^n$  rounded where n is an integer  $\geq 0$ .
  LET P = VEC numupb
  AND R = VEC numupb
  AND T = VEC numupb

  copy(n1,upb1, P,numupb) // To hold the next power of n1

  settok(1, R,numupb) // To hold the result

  WHILE k DO
  { IF (k & 1)>0 DO
    { // Set R = R * P ie multiply R by the current power of n1
      mul(R,numupb, P,numupb, T,numupb)
      copy(T,numupb, R,numupb)
    }
    // Set P to P * P
    mul(P,numupb, P,numupb, T,numupb)
    copy(T,numupb, P,numupb)
    k := k>>1
  }
  copy(R,numupb, n2,upb2)
}

```

The function `checknum`, defined below, is primarily a debugging aid that checks that its argument is valid standardized number.

```

AND checknum(n1,upb1) BE
{ // The calls abort(999) if n1 is not in standard form.
  LET sign, e, d1 = n1!0, n1!1, n1!2
  UNLESS sign=TRUE | sign=FALSE DO
  { writef("n1 has a bad sign field*n")
    writef("n1= "); prnum(n1,upb1)
  }
}

```

```

    abort(999)
    RETURN
}
IF d1=0 DO
{ // Check n1 represents zero.
  FOR i = 0 TO upb1 UNLESS n1!!i=0 DO
  { writef("n1!!2 is zero but other elements are not*n")
    writef("n1= "); prnum(n1,upb1)
    abort(999)
    RETURN
  }
  RETURN
}
// Check that all radix digits are in range 0 to 9999
FOR i = 2 TO upb1 UNLESS 0 <= n1!!i <= 9999 DO
{ writef("Not all radix digits of n1 are in range 0 to 9999*n")
  writef("n1= "); prnum(n1,upb1)
  abort(999)
  RETURN
}
}
}

```

5.17.1 A Simple Example

The `arith` library was developed and tested using a variant of the program in `bcplprogs/tests/testarith.b`, but rather than describing this program, a more interesting program called `fastfib.b` will be presented. This program exercises most of the `arith` library including particularly the functions `div`, `sqrt` and `exptok`. It computes high precision Fibonacci numbers and can be used to find the position of the first Fibonacci number that has 1000 decimal digits which corresponds to problem 25 in the interesting collection of over 500 somewhat mathematical programming problems set in www.ProjectEuler.net These problems range from being quite simple to extremely challenging, and are well worth looking at. This program is as follows.

```

GET "libhdr"

MANIFEST {
  ArithGlobs=350
  numupb = 2+250+10 // Size of numbers used in the library,
                   // good for 1000 decimals 40 check digits.
  nupb   = numupb-5 // Size of numbers used in this program,
                   // allowing 5 guard digits
}

```

```

GET "arith.h"
GET "arith.b"          // Get the high precision library

GLOBAL {
  tracing:ug

  root5
  invroot5
  P          // To hold (1+sqrt(5))/2
  Q          // To hold (1-sqrt(5))/2
  One       // To hold 1.0
  pos      // Position of the fibonacci number
  F        // To hold fib(pos)
  T1       // Temp value
}

LET start() = VALOF
{ LET argv = VEC 50

  UNLESS rdargs("n/N,-t/S", argv, 50) DO
  { writef("Bad arguments*n")
    RESULTIS 0
  }

  pos := 5
  IF argv!0 DO pos := !(argv!0) // pos/N
  tracing := argv!1           // -t/S

  root5 := getvec(nupb)
  invroot5 := getvec(nupb)
  P := getvec(nupb)
  Q := getvec(nupb)
  F := getvec(nupb)
  One := getvec(nupb)
  T1 := getvec(nupb)

  settok(5, T1,nupb)
  sqrt(T1,nupb, root5,nupb)
  inv(root5,nupb, invroot5,nupb)

  IF tracing DO
  { writef("root5=*n")
    prnum(root5,nupb)
    // Check root5
    mul(root5,nupb, root5,nupb, T1,nupb)
  }
}

```

```

writef("root5^2=*n"); prnum(T1,nupb)
newline()

// Check invroot5
writef("invroot5=*n")
prnum(invroot5,nupb)
mul(invroot5,nupb, invroot5,nupb, T1,nupb)
writef("invroot5^2=*n")
prnum(T1,nupb)
}

settok(1, One,nupb)

// Set P to (1 + sqrt(5))/2
add(One,nupb, root5,nupb, P,nupb)
divbyk(2, P,nupb)
IF tracing DO
{ writef("P = (1 + sqrt(5))/2 =*n")
  prnum(P,nupb)
  newline()
}
// Set Q to (1 - sqrt(5))/2
sub(One,nupb, root5,nupb, Q,nupb)
divbyk(2, Q,nupb)
IF tracing DO
{ writef("Q = (1 - sqrt(5))/2 =*n")
  prnum(Q,nupb)
  newline()
}

//writef("Calling fib(%n, F,%n)*n", pos, nupb)
fib(pos, F,nupb) // Compute fibonacci of pos

writef("fib(%n) =*n", pos)
prnum(F,nupb)

{ LET k, d1 = 4*F!1-4, F!2
  UNTIL d1 = 0 DO k, d1 := k+1, d1/10
  IF k<=0 DO k := 1
  writef("Number of decimal digits: %n*n", k)
}

freevec(root5)
freevec(invroot5)
freevec(One)

```

```

freevec(P)
freevec(Q)
freevec(F)
freevec(T1)

RESULTIS 0
}

AND fib(n, n1,upb1) BE
{ LET rc = 0
  LET t1 = VEC numupb
  AND t2 = VEC numupb
  AND t3 = VEC numupb

  exptok(n, P,nupb, t1,nupb)
  IF tracing DO
  { writef("P^%n:*n", n)
    prnum(t1,nupb)
  }
  exptok(n, Q,nupb, t2,nupb)
  IF tracing DO
  { writef("Q^%n=*n",n)
    prnum(t2,nupb)
  }
  sub(t1,nupb, t2,nupb, t3,nupb)
  IF tracing DO
  { writef("P^%n-Q^%n=*n",n,n)
    prnum(t3,nupb)
  }
  mul(t3,nupb, invroot5,nupb, n1,upb1)
  IF tracing DO
  { writef("(P^%n-Q^%n) by sqrt(5) unrounded*n",n,n)
    prnum(n1,upb1)
  }
  rc := roundtoint(n1,upb1)

  UNLESS rc=0 | rc=9999_9999 DO
  { writef("Higer precision required, rc=%z8*n", rc)
    abort(999)
  }
}
}

```

As can be seen it computes $fib(n)$ using the formula derived on page 64, namely:

$$fib(n) = \frac{(1+\sqrt{5})^n - (1-\sqrt{5})^n}{2^n \sqrt{5}}.$$

When this program is run with argument 4782 it generates the following output.

```
0.000> fastfib 4782
fib(4782) =
+0.1070 0662 6638 2758 9367 6498 0584 4573 9688 5083
 6838 9663 2151 6650 1323 5203 3753 1452 0604 6940
 4062 1889 1475 8248 9792 6578 0469 4888 1775 9195
 7484 3364 6667 2569 9595 1299 6030 4612 6274 8092
 4821 8614 4069 4330 5123 4774 4427 5027 3781 7530
 8757 9391 6661 9214 9259 1867 5955 3966 4228 3714
 8943 1130 7469 9503 4395 4700 1985 4326 0972 3067
 2901 9287 0526 4472 4372 6117 7158 2182 5548 4911
 2052 5013 2014 7861 2965 9313 8179 2235 5596 5745
 2039 5061 3755 1467 8375 4322 9119 6021 2993 4048
 2607 0617 5397 7068 4706 8202 8954 8690 2666 1854
 3512 4521 9003 6948 0641 3574 4747 0911 7076 1976
 6945 6910 7009 8024 3934 3961 7474 1037 3691 2503
 2313 6553 2164 7736 9702 3167 7550 5159 5173 5184
 6057 9954 9194 1096 7778 3732 2966 5796 5816 4651
 3903 4881 5425 6310 1842 2419 0259 8460 8800 0110
 1862 5555 0245 4939 3711 3651 6570 3944 7629 5847
 1454 8523 4259 5042 8582 4253 0608 3544 4354 2821
 2611 0089 9286 3795 0480 0689 4330 3097 7321 7834
 8645 4311 3205 7656 5986 8456 2886 1680 8718 6938
 3529 7350 6439 8629 7640 6600 0072 3562 9179 0520
 7051 1640 7761 4812 4918 8583 0945 9405 6668 8339
 1093 5094 4456 5763 5766 6151 6193 1775 3792 8916
 6158 1327 1596 1687 7487 9838 2182 0492 5203 4847
 3874 3847 3677 1934 5127 8702 9218 6362 5062 7816
 0000 0000 0000 0000 0000 0000 E250
Number of decimal digits: 1000
1.550>
```

Although this program may be good for really large fibonacci numbers with perhaps a million digits, the following naive program (`fib1000.b`) is much faster for a mere 1000 digits.

```
/*
This program finds the position of the first fibonacci number having
1000 decimal digits. The first fibonacci number has position zero.
Ie fib(0)=0, fib(1)=1, fib(2)=1, fib(3)=2, fib(4)=3, fib(5)=5, etc

This is a naive implemetation using vectors of digits of radix 100_00_000.
*/
```



```

GET "libhdr"

MANIFEST {
  radix = 100_000_000
  digs  = 1000      // Number of decimal digits
  upb   = digs / 8  // 8 decimal digits per word
}

LET start() = VALOF
{ LET a = getvec(upb)
  AND b = getvec(upb)
  LET upba, upbb = ?, ?
  LET t, upbt = ?, ?
  LET n = ?
  LET w = 1
  LET k = (digs-1) / 8
  FOR i = 1 TO (digs-1) MOD 8 DO w := 10*w

  // Set a=0 and b=1
  FOR i = 0 TO upb DO a!i, b!i := 0, 0
  b!0 := 1
  upba, upbb := 0, 0
  n := 1 // n is the position of the fibonacci number in b

  { IF b!k >= w BREAK

    // b is greater than a
    upba := add(b,upbb, a,upba) // Set a to b + a

    n := n+1 // n is now the position of the fibonacci number in a
    //pr(n, a, upba)

    // Swap a and b
    t, upbt := a, upba
    a, upba := b, upbb
    b, upbb := t, upbt
  } REPEAT

  writef("The first fibonacci number with %n digits is at position %n*n",
        digs, n)

  freevec(a)
  freevec(b)
  RESULTIS TRUE
}

```

```

AND add(a,upba, b,upbb) = VALOF
{ // Add a to b assuming a is greater than b, ie upba>=upbb
  LET carry = 0

  FOR i = 0 TO upba DO
  { LET x = a!i + b!i + carry
    b!i := x MOD radix
    carry := x / radix
  }
  IF carry DO
  { upba := upba+1
    b!upba := carry
  }

  RESULTIS upba
}

AND pr(n, a, upb) BE
{ writef("%i5: ", n)
  FOR i = upb TO 0 BY -1 DO writef(" %i8", a!i)
  newline()
}

```

5.18 The Airy Disk

This program uses the `arith` library described in the previous section to calculate the diffraction pattern caused by a point source of light at infinity observed by a telescope with an aperture of 100mm and focal length of 1000mm.

It does this by considering many rays of light with wave length 550nm passing through an assumed perfect circular objective lens of diameter 100mm causing the wave front to become spherical with a radius of 1000mm centred at the focal point. The effect of rays reaching nearby points on the focal plane are summed taking account of their different phases. The resulting intensities are plotted to show the size of the central spot and the radius of some of the surrounding diffraction rings. The central spot is called the Airy disk named after George Airy who, in 1835, was the first to give a mathematical explanation of this pattern. The mathematical theory states that the radius of the innermost dark ring should be

$$r = 1.22\lambda \times F/A$$

where λ is the wave length of the light (=550nm)
 F is the focal length (=1000mm)
 A is the aperture (=100mm)
 (The ratio F/A is commonly called the F number of
 a camera or telescope)

So for the telescope under consideration

$$r = 1.22 \times (550 \times 10^{-6}) \times 1000/100 = 0.00671mm$$

The program confirms this result. The Rayleigh criterion of barely being able to resolve two close stars is when the centre of the Airy disk of one of the stars is on the edge of the Airy disk of the other. Increasing the magnification of the image will not help.

The program starts as follows.

```
MANIFEST {
  ArithGlobs=350
  numupb = 2+10 // Allow a maximum precision of about 40 decimal digits.
}

GET "libhdr"
GET "arith.h" // Insert the arith high precision library
GET "arith.b"

GET "sdl.h" // Insert the SDL library
GET "sdl.b"

GLOBAL {
  stdin:ug
  stdout

  tracing

  // Colours
  c_black
  c_white
  c_gray
  c_blue
  c_red

  screen // For the SDL graphics
  fmt // The graphics format

  // All numerical values use high precision numbers.
```

```

pvx; pvy; pvz // Vectors holding the coordinates of points
               // on the spherical wave front touching the objective

pvcount       // Count of the number of point in pvx, pvy and pvz.

qvx           // X coordinates of points in the focal plane
qvcount       // Count of the number of points in qvx
intensityv    // Diffraction intensity of points in the focal plane

spacev
spacet
spacep

centrex // Position of (0,0) in the SDL screen
centrey
}

```

The z axis is the axis of the telescope in direction from the objective lens towards the mirror. The x axis is to the right when viewing the objective in the z direction, and y is upwards. The origin is on the z axis in the plane of the thin perfect objective lens. The focal point has coordinates $(0, 0, F)$, where F is 1000mm.

The vectors `pvx`, `pvz` and `pvz` hold the coordinates of thousands of points on the spherical wave front touching the objective lens. Each point is derived from a lattice point in the plane of the objective lens within 50mm of the z axis.

The program continues as follows.

```

MANIFEST {
  pvupb = 101*100 // UPB of the vectors holding the coordinated
                 // of points on the spherical wave front.

  nupb = 2+8     // The size of most high precision numbers used
                 // in the calculation. This setting allows about
                 // 32 decimal digits of precision.

  spacevupb = 1000000

  F = 1000 // The focal length
  A = 100  // The aperture
  Ar = A/2 // Objective lens radius
}

LET drawdot(x, y) BE
{ // Draw a 3x3 dot at (x,y) relative to (centrex,centrey).

```

```

    // This function is used to plot points on the graph.
    LET sx = centrex + x
    LET sy = centrey + y
    drawfillrect(sx-1, sy-1, sx+1, sy+1)
    updatescreen()
}

LET initscreen() BE
{ initsdl()
  mkscreen("Airy Diffraction Pattern", 800, 400)
  // Define some colours
  c_black := maprgb( 0, 0, 0)
  c_white := maprgb(255, 255, 255)
  c_gray  := maprgb(200, 200, 200)
  c_blue  := maprgb( 0, 0, 255)
  c_red   := maprgb(255, 0, 0)

  // Choose the screen position of (0,0)
  centrex := screenxsize/2
  centrey := 60

  writef("screenxsize=%n screenysize=%n*n", screenxsize,screenysize)
  writef("centrex=%n centrey=%n*n", centrex, centrey)

  fillsurf(c_gray)
  updatescreen()
}

LET start() = VALOF
{ LET argv = VEC 50

  stdin  := input()
  stdout := output()

  UNLESS rdargs("-t/s", argv, 50) DO
  { writef("Bad arguments for airy*n")
    RESULTIS 0
  }

  tracing := argv!0 // -t/s

  initscreen()

  spacev := getvec(spacevupb)
  spacet := spacev+spacevupb

```

```

spacep := spacet

mkfront()
drawgraph()

freevec(spacev)

writef("Space used = %n out of %n*n", spacet-spacep, spacevupb)
RESULTIS 0
}

AND newvec(upb) = VALOF
{ LET p = spacep - upb - 1
  IF p < spacev DO
  { writef("*nMore space needed*n")
    abort(999)
    RESULTIS 0
  }
  spacep := p
  FOR i = 0 TO upb DO p!i := 0
  RESULTIS p
}

AND newnum(upb) = newvec(upb)

```

The function `initscreen` creates a suitable SDL window that will be used to draw a graph showing the intensity of points in the focal plane near the z axis. The function `drawdot` draws a 3x3 square representing a point on the intensity curve. The main function `start` reads the command arguments setting the variable `tracing`, but currently this variable is not used. It also allocated some space using `getvec` for use by `newvec` which is mainly used to allocate the vectors holding high precision numbers. Before returning from `start` it calls `freevec` to return the space obtained by `getvec`.

```

AND mkfront() BE
{ // Create the coordinates of all the points on the
  // spherical wave front.
  LET t1 = VEC nupb
  AND t2 = VEC nupb
  AND t3 = VEC nupb

  MANIFEST { step=4 }

  // step controls the number of points chosen in the objective lens.
  // The larger step is the faster the program runs but the resulting

```

```

// graph becomes less accurate.

pvcount := 0
pvx := newvec(pvupb) // These will hold the x, y and z coordinated
pvy := newvec(pvupb) // of points on the spherical wave front.
pvz := newvec(pvupb)

FOR x = 0 TO +Ar BY step DO
  FOR y = 0 TO +Ar BY step IF x*x+y*y <= Ar*Ar DO
  { // (x,y) are the coordinates of a lattice point in the plane of
    // the objective lens within a distance Ar from the z axis.
    LET Fnum = TABLE FALSE, 1, F // F as a high precision number.

    // (x,y,0) is a point in the first quadrant of the objective lens
    LET dx = VEC nupb
    AND dy = VEC nupb
    AND dz = VEC nupb

    LET nx, ny, nz = ?, ?, ? // Three will hold the x,y and z
                                // coordinates of a point on the
                                // spherical wave front.

    //writef("nx=%i3 y=%i3*n", x, y)
    //abort(1000)

    settok( x, dx,nupb) // Direction of the line from the focal point
    settok( y, dy,nupb) // to the point (x,y,0) in the objective lens.
    settok(-1000, dz,nupb)

    //writef("dx= "); prnum(dx, nupb)
    //writef("dy= "); prnum(dy, nupb)
    //writef("dz= "); prnum(dz, nupb)

    normalize(@dx,nupb)

    //writef("nAfter normalisation we have direction cosines*n")
    //writef("dx= "); prnum(dx, nupb)
    //writef("dy= "); prnum(dy, nupb)
    //writef("dz= "); prnum(dz, nupb)
    //newline()
    // (dx,dy,dz) is now a unit vector in direction focal point to (x,y,0)

    // Multiply dx by F
    mulbyk(F, dx,nupb)
    //writef("Multiply dx by F where F=%n*n", F)

```

```

//writef("dx= ");prnum(dx,nupb)
//newline()

// Multiply dy by F
mulbyk(F, dy,nupb)
//writef("Multiply dy by F where F=%n*n", F)
//writef("dy= ");prnum(dy,nupb)
//newline()

mulbyk(F, dz,nupb)
//writef("Multiply dz by F where F=%n*n", F)
//writef("dz= ");prnum(dz,nupb)
//newline()

// Add the coordinates (0,0,1000) of the focal point
add(Fnum,2, dz,nupb, t1,nupb)
copy(t1,nupb, dz,nupb)
//writef("Add F to the z coordinate where F=%n*n", F)
//writef("dz= ");prnum(dz,nupb)

// (dx,dy,dz) is now a point on the spherical wave front in
// the first quadrant.

nx := newnum(nupb) // Allocate the numbers to hold the
ny := newnum(nupb) // x, y and z coordinates of a point
nz := newnum(nupb) // on the spherical wave front.

copy(dx,nupb, nx,nupb)
copy(dy,nupb, ny,nupb)
copy(dz,nupb, nz,nupb)

// Store these coordinates in pvx, pvy and pvz.
pvcount := pvcount+1
pvx!pvcount := nx // A point in the first quadrant
pvy!pvcount := ny // ie nx>=0 and ny>=0
pvz!pvcount := nz
//writef("Wave front point %i4 for (%i3,%i3)*n", pvcount, x,y)
//writef("x= "); prnum(nx, 4)
//writef("y= "); prnum(ny, 4)
//writef("z= "); prnum(nz, 4)

IF x=0 & y=0 LOOP

UNLESS x=0 DO
{ nx := newnum(nupb) // Allocate the numbers to hold the

```



```

ny := newnum(nupb) // x, y and z coordinates of a point
nz := newnum(nupb) // on the spherical wave front.

copy(dx,nupb, nx,nupb)
copy(dy,nupb, ny,nupb)
copy(dz,nupb, nz,nupb)

nx!0 := TRUE // Negate just x -- second quadrant
pvcount := pvcount+1
pvx!pvcount := nx // A point in the second quadrant
pvy!pvcount := ny // ie nx<0 and ny>=0
pvz!pvcount := nz
//writef("Wave front point %i4 for (%i3,%i3)*n", pvcount, -x,y)
//writef("x= "); prnum(nx, 4)
//writef("y= "); prnum(ny, 4)
//writef("z= "); prnum(nz, 4)
}

IF x>0 & y>0 DO
{ nx := newnum(nupb) // Allocate the numbers to hold the
ny := newnum(nupb) // x, y and z coordinates of a point
nz := newnum(nupb) // on the spherical wave front.

copy(dx,nupb, nx,nupb)
copy(dy,nupb, ny,nupb)
copy(dz,nupb, nz,nupb)

nx!0, ny!0 := TRUE, TRUE // Negate x and y -- third quadrant
pvcount := pvcount+1
pvx!pvcount := nx // A point in the third quadrant
pvy!pvcount := ny // ie nx<0 and ny<0
pvz!pvcount := nz
//writef("Wave front point %i4 for (%i3,%i3)*n", pvcount, -x,-y)
//writef("x= "); prnum(nx, 4)
//writef("y= "); prnum(ny, 4)
//writef("z= "); prnum(nz, 4)
}

IF x>=0 & y>0 DO
{ nx := newnum(nupb) // Allocate the numbers to hold the
ny := newnum(nupb) // x, y and z coordinates of a point
nz := newnum(nupb) // on the spherical wave front.

copy(dx,nupb, nx,nupb)
copy(dy,nupb, ny,nupb)

```

```

copy(dz,nupb, nz,nupb)

ny!0 := TRUE          // Negate just y -- Fourth quadrant
pvcount := pvcount+1
pvx!pvcount := nx    // A point in the fourth quadrant
pvy!pvcount := ny    // is nx>=0 and ny<0
pvz!pvcount := nz
//writef("Wave front point %i4 for (%i3,%i3)*n", pvcount, x,-y)
//writef("x= "); prnum(nx, 4)
//writef("y= "); prnum(ny, 4)
//writef("z= "); prnum(nz, 4)
}
}

writef("Number of points on the wave front = %n*n", pvcount)
//abort(1001)
}

```

This function considers every grid point in the plane of the objective lens that is no more than A_r (50mm) from the z axis. For each point it constructs a line to the focal point and computes the coordinates of the point on this line that is 1000mm from the focal point. These coordinates are placed in the vectors `pvx`, `pvy` and `pvz`. Since the telescope is symmetric about the z axis, the computation is only done for points in the first quadrant (when $x \geq 0$ and $y \geq 0$). The coordinates of points on the wave front in the other quadrants just involve sign changes.

You can imagine the result is a circular disc with a shallow spherical depression uniformly covered with thousands of point sources of light, and since they are on the wave front they will all be in phase.

The next function `drawgraph` draws the graph showing the intensity of the resulting image at points in the focal plane close to the z axis.

```

AND drawgraph() BE
{
  moveto(0, centrey)
  drawto(screenxsize, centrey)
  moveto(centrex, 0)
  drawto(centrex, screenysize)

  setcolour(c_black)
  moveto(centrex- 671*3/10, centrey-20)
  drawto(centrex- 671*3/10, centrey+20)
  plotf (centrex- 671*3/10 - 40, centrey-40, "-0.00671mm")

  moveto(centrex+ 671*3/10, centrey-20)

```

```

drawto(centrex+ 671*3/10, centrey+20)
plotf (centrex+ 671*3/10 - 40, centrey-40, "+0.00671mm")

updatescreen()

// Plot the intensity points
FOR r = 0 TO 126 BY 1 DO // r is in units of 0.0001mm
{ LET fx = VEC nupb // To hold the coordinates of a point on the focal
  LET fy = VEC nupb // plane at a distance r from the z axis.
  LET fz = VEC nupb

  LET t1 = VEC nupb
  LET lambda = VEC nupb // To hold the wave length 550nm.
  LET angle = 0
  LET sum = 0

  str2num("0.000550", lambda,nupb) // Average wave length of visible light
  //writef("lambda= "); prnum(lambda, nupb)

  settok(r, fx,nupb)
  UNLESS r=0 DO fx!1 := fx!1 - 1 // Divide fx by 10000
  setzero(fy,nupb)
  settok(1000, fz,nupb)

  // Iterate through all the points on the wave front.
  FOR i = 1 TO pvcount DO
  { LET x = pvx!i // Coordinates of the next point
    LET y = pvy!i
    LET z = pvz!i

    LET dx = VEC nupb
    AND dy = VEC nupb
    AND dz = VEC nupb
    AND d = VEC nupb

    AND diff = VEC nupb // The difference between the length
                        // the ray from the selected point on
                        // the wave front to the selected point
                        // the focal plane.

    //writef("ni=%i4 r=%7.4dmm*n", i, r)
    //writef("fx= "); prnum(fx, nupb)
    //writef("fy= "); prnum(fy, nupb)
    //writef("fz= "); prnum(fz, nupb)

```

```

//writef("x= "); prnum(x, nupb)
//writef("y= "); prnum(y, nupb)
//writef("z= "); prnum(z, nupb)

//writef("Calling sub(x,nupb, fx,nupb, dx,nupb)*n")
//writef("x= "); prnum(x, nupb)
//writef("fx= "); prnum(fx, nupb)

sub(x,nupb, fx,nupb, dx,nupb)
sub(y,nupb, fy,nupb, dy,nupb)
sub(z,nupb, fz,nupb, dz,nupb)

//writef("dx= "); prnum(dx, nupb)
//IF i=54 D0 abort(5544)
//writef("dy= "); prnum(dy, nupb)
//writef("dz= "); prnum(dz, nupb)
radius(@dx,nupb, d,nupb)
//writef("d= "); prnum(d, nupb)

// d is the distance between the selected point on the wave front
// and the selected point in the focal plane.

sub(d,nupb, fz,nupb, diff,nupb)
//writef("diff="); prnum(diff, nupb)
div(diff,nupb, lambda,nupb, t1,nupb)
//writef("t1= "); prnum(t1, nupb)

// t1 is diff divided by the wavelength of light.
// The integer part of t1 is the number of complete wavelengths
// in diff, and the fractional part is the phase represents
// as a number in the range -0.9999 to +0.9999. For digits
// of precision is sufficient so we set angle to the
// first 4 decimal digits after the decimal point. -1.0000
// represents -180 degrees and +1.0000 represents +180 degrees.

angle := -1
IF t1!1= 1 D0 angle := t1!3
IF t1!1= 0 D0 angle := t1!2
IF t1!1< 0 D0 angle := 0

IF angle<0 D0
{ writef("System error: angle too large*n")
  abort(999)
}

```

```

    IF t1!0 DO angle := -angle

    // angle is in the range -9999 to +9999,
    // representing -180 to +180 degrees.
//writef("fx= "); prnum(fx, nupb)
//writef("t1= "); prnum(t1, nupb)
    //writef("angle=%8.4d*n", angle)
//abort(1000)

    // We now convert this angle to radians and take the cosine
    // which we then convert to a number in the range -1_0000 to +1_0000.
    { LET fangle = sys(Sys_flt, fl_float, angle)
      LET x = sys(Sys_flt, fl_cos,
                  2.0 ** 3.14159 ** fangle #/ 1_0000.0)
      LET cosangle = sys(Sys_flt, fl_fix, x ** 10000.0)
      // We add all the cosines
      sum := sum + cosangle
      //writef("%i4/%i4: %8.4d sum=%8.4d*n", i, pvcount, cosangle, sum)
    }
//IF i>=53 DO
    //IF r=126 DO abort(1001)
}

sum := sum / pvcount // Take the average cosine
sum := sum*sum/10000 // and square it to give the intensity.
writef("r=%7.4d mm intensity= %i6*n", r, sum)
//abort(1001)
setcolour(c_black)
drawdot(+r*3, sum/30) // Plot the resulting two points
drawdot(-r*3, sum/30)
updatescreen()
//abort(1002)
}
}

```

Strictly speaking, we should take the average of intensities over many different phases of the wave front. But even without doing this the resulting graph is reasonably accurate. Note that the point on the z axis will give the maximum intensity and points at a distance of 0.00671mm where the first dark ring occurs has intensity zero corresponding to an amplitude of zero for all phases of the wave front.

When this program, runs it generates the following window showing a graphs that confirms that, for a telescope with a 100mm objective lens and a focal length of 1000mm, the Airy disk has a radius of 0.00671mm.

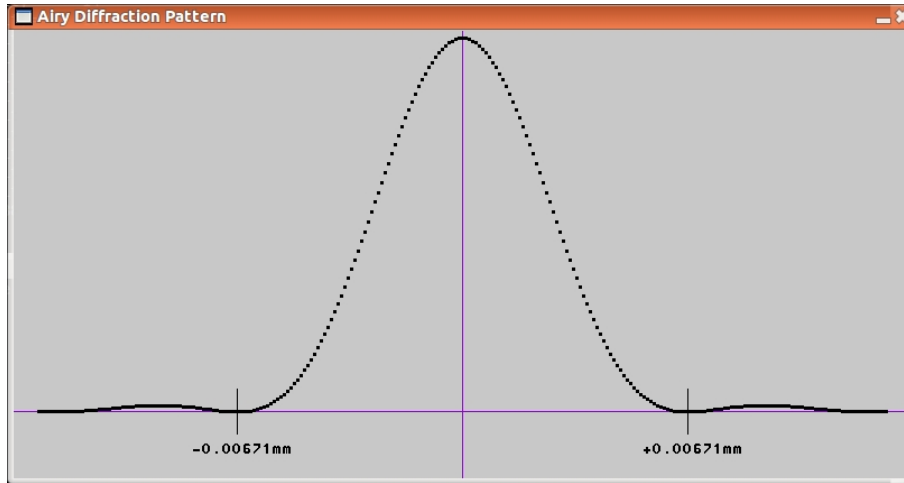

5.19 A Catadioptric Telescope

This program is a demonstration of ray tracing through lenses and mirrors. It concentrates on the design of a Hamiltonian catadioptric telescope consisting of a convex objective made of crown glass and a mirror made of flint glass silvered on its back surface. All the surfaces are spherical but the resulting spherical aberration can be minimised by careful placement of the mirror and the choice of the radii of four optical surface. At the same time chromatic aberration can also be minimized. The objective lens and mirror are arranged as follows.

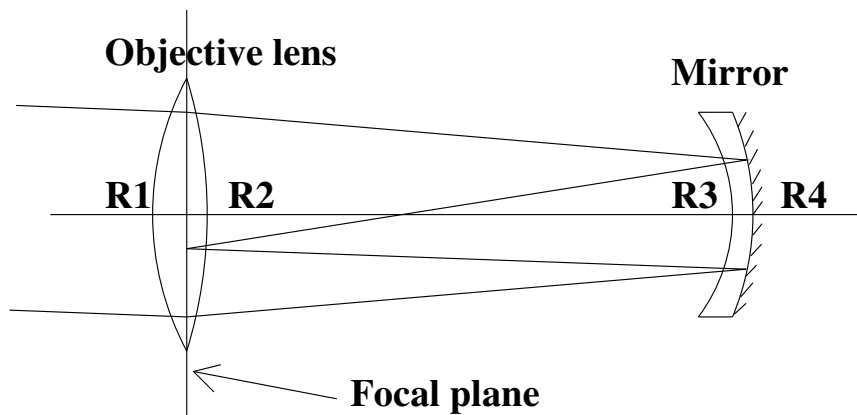

Analysis of optical instruments is renowned for requiring high precision arithmetic, so the `arith` is used library to perform the calculations to sufficient precision. Currently numbers with with about 60 significant decimal digits are used while allowing the library functions to use upto 72. This precision can be changed easily if required.

The program uses a BCPL system that includes the SDL graphics library since it draws an image on the focal plane resulting from point sources of blue and red light light at infinity from directions on or near the axis of the telescope.

For each direction, 17 rays are chosen using different entry points through the objective lens. Since spherical and chromatic aberration cannot be fully corrected the images contain scatterings of blue and red dots. The program attempts to improve the geometry of the telescope iteratively minimising this scattering. The iteration only changes the radii of the spherical front and rear surfaces of the objective lens and the front and rear surfaces of the mirror. From a well chosen initial setting the program can find a near optimum design for the telescope. If we can obtain a design that causes the scattering to be no larger than the size of the corresponding Airy disk, further optimization will not improve the resolution of the telescope.

The program is called `cataopt.b` and starts as follows, declaring all the global variables and manifest constants needed.

```
MANIFEST {
    ArithGlobs=350
    numupb = 2+18    // Allow a maximum precision of about 72 decimal digits
}

GET "libhdr"
GET "arith.h"
GET "arith.b"

GET "sdl.h"
GET "sdl.b"

// Compile the arith library as a separate section.
.

MANIFEST {
    ArithGlobs=350
    numupb = 2+18    // Allow a maximum precision of about 72 decimal digits
}

GET "libhdr"
GET "arith.h"
GET "sdl.h"

GLOBAL {
    stdin:ug
    stdout

    spotmag          // This specified the magnification of spot
                    // drawn by drawdot.

    pausing          // Pause when the geometry improves

    tracing
```

```

reduced          // =TRUE when the geometry improves

// Colours
c_black
c_white
c_gray
c_blue
c_red

screen // For the SDL graphics
fmt    // The graphics format

R1 // Objective lens front radius
prevR1
C1 // Centre of objective lens front
R2 // Objective lens rear radius
prevR2
C2 // Centre of objective lens rear surface
R3 // Concave mirror front radius
prevR3
C3 // Centre of concave mirror front surface
R4 // Concave mirror silvered surface radius
prevR4
C4 // Centre of concave mirror silvered surface
T1 // Objective thickness
T2 // Mirror thickness

MirrorRadius // Actual mirror radius

D // The distance between the objective and mirror.
  // Typically about 700mm
F // The z coordinate of the focus plane. Typically F=0

deltaR1
deltaR2
deltaR3
deltaR4

factor          // A power of ten used in computing the next delta
initfactor      // This hold the value of the f argument

spotsize        // Current spot size or -1

dist            // Distance from y average to theoretical y centre.
spotvalue       // Set to spotsize+5*dist

```



```

bestspotvalue // The best spotvalue so far
bestdist      // Set to dist of the best spotvalue.
bestspotsizes // Set to spotsizes of the best spotvalue.

// Directions at small angles in the y-z plane
dir0cx; dir0cy; dir0cz // Parallel to the telescope axis.
dir1cx; dir1cy; dir1cz // about 1/8 degrees of the axis.
dir2cx; dir2cy; dir2cz // about 1/4 degrees off the axis.

Inx; Iny; Inz // Coordinates of the entry point in plane z=0
Outx; Outy; Outz // Coordinates of the exit point on the front
                // surface of the mirror.
outdircx; outdircy; outdircz // Direction of the out ray

Arad // Radius of the A circle in the objective, typically 50mm
Brad // Radius of the B circle in the objective, typically 25mm

root2 // Two useful constants
one

spacev
spacet
spacep

currentline // A byte vector with upb=255, used
            // when reading catageometry.txt

iterations // Number of iterations to perform

spot0vx // Dot coordinates in the focal plane
spot0vy // resulting from point light sources
spot1vx // from three directions, 0, 1/8 and
spot1vy // 1/4 degree from the axis. Note the
spot2vx // moon has an angular radius of
spot2vy // about 1/4 degree.

geometrystream // Used when reading or writing catageometry.txt
              // This holds the latest setting of R1 to R4.

// The refractive indices of crown and flint glass
// for both air to glass and glass to air.
crownblueindex; crownblueinindex
crownredindex; crownredinindex
flintblueindex; flintblueinindex
flintredindex; flintredinindex

```

```

centrex // Centre of the SDL screen
centrey
}

MANIFEST {

nupb = 2+15 // Size of most high precision numbers, allowing
           // about 60 decimal digits of precision.
// If p is a number
// p!0      TRUE is negative, = FALSE otherwise
// p!1      The exponent, ie the power of 10000 to multiple or
//          divide the fractinal part by.
// p!2 .. p!upb is the fractional part representing a
//          value in the range 0 to 1.0

spacevupb = 10000

Blue=1    // Specifying colours used in raytrace.
Red=2
}

```

The z -axis is the axis of the telescope in direction from the centre of the objective lens towards the mirror. The x -axis is to the right when viewing the objective in the z direction, and y is upwards. The origin is on the z axis at the centre of the objective lens. The separation D is the z coordinate of where the silvered surface of the mirror intersects the z -axis. The focal plane is at $z=0$ and the setting of $D=700$ allows the telescope to have a focal length of between 700mm and 1400mm. The optimisation process aims for a focal length of 1000mm.

The program continues as follows.

```

LET drawdot(dir, x, y) BE
{ // Draw a 3x3 dot at (x,y) relative to (centrex,centrey)
  // x and y are in units of 1/10000mm.
  // dir = 0, 1 or 2 specifying the direction of the
  // incoming ray.
  // Direction 1 the image spot on the focal plane is centred
  // at x=0 and y = - 1000*/(8*60) = -2.0833mm
  // For direction 2 the y coordinate is -4.1666mm

  LET spotcentrex = centrex
  LET spotcentrey = centrey - muldiv(screenysize, 2_0833*dir, 8_0000)

  // Place the dot relative to the origin
  y := y + 2_0833*dir
}

```

```

// Magnify the spot dot
x, y := x * spotmag, y * spotmag

// These are in units of 1/10000mm relative to the spot centre.

// Convert to screen coordinates assuming screen size is
// equivalent to 8mm
x := spotcentrex + (screen size * x) / 8_0000
y := spotcentrey + (screen size * y) / 8_0000

drawfillrect(x-1, y-1, x+1, y+1) // Draw a 3x3 dot

setcolour(c_black)
moveto(spotcentrex-10, spotcentrey)
drawto(spotcentrex+10, spotcentrey)

updatescreen()
IF tracing DO
{ writef("drawdot: x=%n y=%n*n", x,y)
  //abort(1077)
}
}

```

The function `drawdot`, defined above, plots a the point on the focal plane corresponding to a ray through the telescope originating from a blue or red point source at infinity. The argument `dir` is 0, 1 or 2 specifies the direction of the incoming ray. The function also draws a short horizontal line through the y -axis indicating the theoretical position of the centre of the image of a star from this direction assuming the focal length of the telescope is 1000mm. To make the scattering of points more visible their distance from the theoretical centre is magnified by the factor `spotmag` whose default value is 20. It can be changed using the `mag` option when `cataopt` is called. For a reasonable telescope design each image spot has a size of about two pixels when `spotmag=1`.

Since `cataopt` draws and image on the screen using the SDL graphics library, it must initialise SDL and create a window in which to draw it. This is done by the function defined below.

```

LET initscreen() BE
{ initsdl()
  mkscreen("Catadioptric", 500, 500)

  // Define some colours
  c_black := maprgb( 0, 0, 0)
  c_white := maprgb(255, 255, 255)
}

```

```

c_gray := maprgb(200, 200, 200)
c_blue := maprgb( 0,  0, 255)
c_red  := maprgb(255,  0,  0)

// Choose the screen position of (0,0)
centrex := screenxsize/2
centrey := screenysize - 60
fillsurf(c_gray)
updatescreen()
}

```

The next function `start` is the main function of `cataopt`. It reads the command arguments using `rdargs` and after setting `iterations` and `spotmag` and initialising SDL by the call `initsdl()`. It enters the function `telescope` to optimise the geometry of the telescope. The `f` argument overrides the setting `t` factor that controls the maximum size for the delta values used in choosing another setting of R1 to R4. The `-p` argument causes the program to pause every time a new setting of R1 to R4 has been processed. The `-t` argument causes some debugging output to be generated while the program runs. More debugging output can be generated by uncommenting various `writeln` and `abort`. Since the program allocates space for many high precision numbers, it is convenient to allocate one area for the using `getvec`. This space is used by `newvec` and `newnum` that are defined later.

```

LET start() = VALOF
{ LET argv = VEC 50
  LET str = VEC 255/bytesperword
  currentline := str

  stdin := input()
  stdout := output()

  UNLESS rdargs("mag/n,n/n,f/n,-p/s,-t/s", argv, 50) DO
  { writeln("Bad arguments for cataopt*n")
    RESULTIS 0
  }

  spotmag := 20
  IF argv!0 DO spotmag := !argv!0 // mag/n

  iterations := 1000
  IF argv!1 DO iterations := !argv!1 // n/n

  initfactor := 0
  IF argv!2 DO initfactor := !argv!2 // f/n

```

```

pausing := argv!3           // -p/s
tracing := argv!4          // -t/s

spacev := getvec(spacevupb)
spacet := spacev + spacevupb
spacep := spacet

UNLESS spacev DO
{ writef("nERROR: More memory is needed*n")
  RESULTIS 0
}

initscreen()

// Analyse the catadioptric telescope, hopefully optimising its
// geometry.

telescope()

IF spacev DO
{ writef("Space used is %n out of %n*n", spacet-spacep, spacevupb)
  freevec(spacev)
}

RESULTIS 0
}

```

The program spends most of its time tracing rays of blue and red light through the telescope. The effect of refraction must be calculated as the ray enters or leaves the objective lens. It must also deal with the refraction and reflection as the ray passes through the mirror. Luckily the underlying mathematics is quite simple making the program easy to write and understand, even though it is quite long.

We must first choose a way to represent a ray. Our selected method is to choose a point, P , on the ray specified by coordinate (x, y, z) and the direction of the ray using direction cosines (u, v, w) . You will remember that direction cosines represent a 3D vector of unit length, so $(x, y, z) + (u, v, w)t = (x + ut, y + vt, z + wt)$ represent the coordinates of a point on the ray at a distance t from P . In this program, P is always either a point in the focal plane ($z = 0$) or a point on the spherical surface of the lens or mirror.

Having chosen our representation of a ray, we need a mathematical representation of a spherical surface. This is simple since every point (x, y, z) on it must be at a constant distance R from the centre of the sphere. Assuming the centre is at coordinate $(0, 0, c)$, the resulting equation is: $x^2 + y^2 + (z - c)^2 = R^2$. The centre of each spherical surface is always on the z axis, so both its x and y coordinates are zero.

We will frequently need to calculate the coordinates of the point where a ray intersects the spherical surface of a lens or mirror. This is easily done by substituting the

coordinates of the point on the ray at distance t from P in the equation of the sphere. This gives us the following equation:

$$(x + vt)^2 + (y + wt)^2 + (z + wt - c)^2 = R^2$$

which simplifies to the following quadratic in t :

$$At^2 + Bt + C = 0$$

where

$$\begin{aligned} A &= u^2 + v^2 + w^2 = 1 \\ B &= 2(xu + yv + (z - c)w) \\ C &= x^2 + y^2 + (z - c)^2 - R^2 \end{aligned}$$

Since $A = 1$, the quadratic equation yield two solutions for t , namely:

$$\begin{aligned} t &= (-B + \sqrt{B^2 - 4C})/2 \\ t &= (-B - \sqrt{B^2 - 4C})/2 \end{aligned}$$

The function places the two solutions in the given high precision numbers `t1` and `t2`, returning `TRUE` if successful. If the ray does not intersect the sphere the result is `FALSE`, but in this program this never happens. The definition of `intersect` is as follows.

```

AND intersect(dir, P, c, r, t1, t2) = VALOF
{ // This calculates the intersection points of a line and
  // a sphere.
  // dir!0,dir!1,dir!2 are the direction cosines of the line
  // P!0,P!1,P!2 is a point on it.
  // c is the z coordinate of the centre of the lens surface
  // r is the radius of the lens surface.
  // P+t1*dir and P+t2*dir are the intersection points, if any.
  // The result is TRUE is t1 and t2 exist.

  // All the numbers above have upperbound nupb.

  // A point on the line has coordinates
  // x = P!0 + dir!0*t
  // y = P!1 + dir!1*t
  // z = P!2 + dir!2*t

  // These must be on the surface of the sphere, so
  // x^2 + y^2 + (z-c)^2 = r^2

  // This gives a quadratic of the form At^2 + Bt + C = 0

  // where

```

```

// A = dx^2 + dy^2 + dz^2 = 1

// B = 2(xdx + ydy + (z-c)dz)

// C = x^2 + y^2 + (z-c)^2 - r^2

// giving the solutions:  t = (-B +/- sqrt(B^2 - 4AC))/2A
// and since A=1          t = (-B +/- sqrt(B^2 - 4C))/2
LET x      = P!0
LET y      = P!1
LET z      = P!2
LET dx     = dir!0
LET dy     = dir!1
LET dz     = dir!2
LET tmp1   = VEC numupb
LET tmp2   = VEC numupb
LET tmp3   = VEC numupb
LET tmp4   = VEC numupb
LET tmp5   = VEC numupb
LET B      = VEC nupb
LET C      = VEC nupb

mul(x,nupb, dx,nupb, tmp1,numupb)      // tmp1 = x dx
mul(y,nupb, dy,nupb, tmp2,numupb)      // tmp2 = y dy
sub(z,nupb, c,nupb, tmp3,numupb)       // tmp3 = z - c
mul(tmp3,numupb, dz,nupb, tmp4,numupb) // tmp4 = (z - c)dz

add(tmp1,numupb, tmp2,numupb, tmp3,numupb) // tmp3 = xdx + ydy
add(tmp3,numupb, tmp4,numupb, B,nupb)      // B = xdx + ydy + (z - c)dz
mulbyk(2, B,nupb)                          // B = 2(xdx + ydy + (z - c)dz)

mul(x,nupb, x,nupb, tmp1,numupb)        // tmp1 = x^2
mul(y,nupb, y,nupb, tmp2,numupb)        // tmp2 = y^2
sub(z,nupb, c,nupb, tmp3,numupb)        // tmp3 = z-c
mul(tmp3,nupb, tmp3,nupb, tmp4,numupb)   // tmp4 = (z-c)^2
mul(r,nupb, r,nupb, tmp5,numupb)        // tmp5 = r^2
add(tmp1,numupb, tmp2,numupb, C,nupb)    // C = x^2+y^2
add(C,nupb, tmp4,numupb, tmp1,numupb)    // tmp1 = x^2+y^2+(z-c)^2
sub(tmp1,numupb, tmp5,numupb, C,nupb)    // C = x^2+y^2+(z-c)^2-r^2

mul(B,nupb, B,nupb, tmp1,numupb)        // tmp1 = B^2
mulbyk(4, C,nupb)                       // C = 4C
sub(tmp1,numupb, C,nupb, tmp2,numupb)    // tmp2 = B^2 - 4C
sqrt(tmp2,numupb, tmp3,numupb)          //tmp3 = sqrt(B^2 - 4C)
neg(B,nupb)                              // B = -B

```

```

sub(B,nupb, tmp3,numupb, t1,nupb)
divbyk(2, t1,nupb)          // t1 = (-B - sqrt(B^2 - 4C))/2
add(B,nupb, tmp3,numupb, t2,nupb)
divbyk(2, t2,nupb)          // t2 = (-B + sqrt(B^2 - 4C))/2
RESULTIS TRUE
}

```

The next function, `refract`, takes arguments specifying the inward direction (`indir`) of a ray, the coordinates of the intersection point (`point`) on a spherical surface, the z coordinate of the centre of the sphere and the inverse of the refractive index (`index`) of boundary. The inverse is used since this allows `mul` to be used instead of `div` which is more efficient. These quantities allow the function to calculate the direction cosines of the outgoing ray using Snell's law. This law states that, when a ray of light passes through the boundary between two media such as air to glass, the ratio of the sines of the angles of incidence and refraction is the refractive index of the boundary. The boundary from air to crown glass has a refractive index is about 1.5 but this varies slightly on the wavelength of the light. For the the boundary glass to air the inverse $1/1.5$ is used.

The angle on incidence is the angle between the ray and the normal at the point P where the ray intersects the boundary. Normal is a mathematical term for the direction perpendicular to a surface. For all our surfaces the normal is easy to calculate since its direction is from the centre of the spherical surface to P . If $P = (x, y, z)$ and the centre is at $(0, 0, c)$ then a 3D vector in the direction of the normal is $(x, y, z - c)$ and this can be converted to direction cosines by calling `standardize`. We can calculate the cosine of the angle of incidence (θ) by evaluating the inner produce of `indir` and the normal, but we may have to negate the normal first so that they are both advancing more or less the same direction. Why the inner product of two direction cosines yields the cosine of the angle between them is explained on page 602. Having calculated $\cos \theta$ we can easily compute $\sin \theta$ using the formula: $\cos^2 \theta + \sin^2 \theta = 1$ that was derived on page 326.

Assuming P is the intersection point on the lens surface we can calculate a point $P1$ on the incoming ray one unit from P by subtracting the direction cosines `indir` from P . We have already calculated $\cos \theta$ so we can easily calculate the coordinates of a point $P2$ on the normal a distance of $\cos \theta$ from P and on the same side of the surface as $P1$. We now have a right angled triangle with vertices P , $P1$ and $P2$, and the length of the edge from $P1$ to $P2$ is $\sin \theta$. Snell's law tells us that $\sin \phi$, where ϕ is the angle of refraction, equals $\sin \theta$ divided by the refractive index. We can easily construct a triangle with vertices P , $Q1$ and $Q2$ in the same plane as the first triangle $P - P1 - P2$ with $Q2$ on the normal at a distance $\cos \phi$ from P , and $Q1$ chosen to be on the line through $Q2$ parallel to $P1 - P2$ with the length of $Q1 - Q2$ equal to $\sin \phi$. The triangle $P - Q1 - Q2$ is thus a right angled triangle with the outgoing ray lying along $P - Q1$, and since

$P - Q1$ is already of unit length the components are the direction cosines of the refracted ray. The definition of `refract` is as follows.

```

AND refract(indir, P, c, invindex, outdir) = VALOF
{ // indir!0,indir!1,indir!2 are the direction cosines
  //                               of the in ray.
  // P!0,P!1,P!2 are the coordinates of the entry
  //                               point P on the lens surface.
  // c       is the z coordinate of the lens surface centre.
  // invindex is the inverse of the refractive index air to glass.
  // outdir!0,outdir!1,outdir!2 will be the direction cosines
  //                               of the out ray.
  // All numbers have upper bound nupb.
  // The result is TRUE if refract is successful.

  LET indx = indir!0 // The direction cosines of the in ray.
  AND indy = indir!1
  AND indz = indir!2

  LET Px = P!0 // The coordinates of the entry point.
  AND Py = P!1
  AND Pz = P!2

  LET outdx = outdir!0 // To hold the direction cosines of the out ray.
  AND outdy = outdir!1
  AND outdz = outdir!2

  LET ndx      = VEC nupb // The surface normal direction cosines
  AND ndy      = VEC nupb // with the same z sign as for indir.
  AND ndz      = VEC nupb

  AND costheta = VEC numupb // The in ray
  AND sintheta = VEC numupb
  AND cosphi   = VEC numupb // The out ray
  AND sinphi   = VEC numupb

  LET P1x      = VEC nupb // The point P1 on the in ray
  AND P1y      = VEC nupb // costheta away from P
  AND P1z      = VEC nupb

  LET P2x      = VEC nupb // The point P2 on the in normal
  AND P2y      = VEC nupb // at distance 1 from P
  AND P2z      = VEC nupb

  LET Q1x      = VEC nupb // The point Q1 on the out normal
  AND Q1y      = VEC nupb // cosphi away from P

```

```

AND Q1z      = VEC nupb

LET Q2x      = VEC nupb    // The point Q2 on the out ray
AND Q2y      = VEC nupb    // at distance 1 from P
AND Q2z      = VEC nupb

// Note that P-P1-P2 and P-Q1-Q2 are both right
// angle triangles lying in the same plane, and that
// P1-P2 has length sintheta and Q1-Q2 has length sinphi.
// By Snell's law, the ratio of these lengths is the
// refractive index.
// ie sintheta = sinphi / index = sinphi * invindex

AND tmp1 = VEC numupb
AND tmp2 = VEC numupb
AND tmp3 = VEC numupb
AND tmp4 = VEC numupb

copy(Px,nupb,      ndx,nupb)
copy(Py,nupb,      ndy,nupb)
sub (Pz,nupb, c,nupb, ndz,nupb)
// (Px,Py,Pz are the coordinates of
// the entry point on the lens.
// (ndx,ndy,ndz) is a vector parallel to the normal.

// Ensure that the normal and indir have the same z sign,
// negating (ndx,ndy,ndz) if necessary.
UNLESS indz!0=ndz!0 DO
{ // The z signs are different, so negate the normal.
  neg(ndx)
  neg(ndy)
  neg(ndz)
}

normalize(@ndx,nupb) // Direction cosines of the normal
// (ndx,ndy,ndz) are now direction cosines.

inprod(indir,nupb, @ndx,nupb, costheta,numupb)
// theta is the angle between the incident ray and the normal.
mul(costheta,numupb, costheta,numupb, tmp1,numupb)
sub(one,nupb, tmp1,numupb, tmp3,numupb)
sqrt(tmp3,numupb, sintheta,numupb)

mul(sintheta,numupb, invindex,nupb, sinphi,numupb) // Apply Snell's law

```

```

mul(sinphi,numupb, sinphi,numupb, tmp1,numupb)
sub(one,nupb, tmp1,numupb, tmp3,numupb)
sqrt(tmp3,numupb, cosphi,numupb)

// P1 is on the in ray at distance 1 from P
sub(Px,nupb, indx,nupb, P1x,nupb)
sub(Py,nupb, indy,nupb, P1y,nupb)
sub(Pz,nupb, indz,nupb, P1z,nupb)

// Point P2 is on the normal at distance costheta from P
mul(ndx,nupb, costheta,numupb, tmp1,numupb)
sub(Px,nupb, tmp1,numupb, P2x,nupb)
mul(ndy,nupb, costheta,numupb, tmp1,numupb)
sub(Py,nupb, tmp1,numupb, P2y,nupb)
mul(ndz,nupb, costheta,numupb, tmp1,numupb)
sub(Pz,nupb, tmp1,numupb, P2z,nupb)

// Point Q1 is on the normal at distance cosphi from P.
mul(ndx,nupb, cosphi,numupb, tmp1,numupb)
add(Px,nupb, tmp1,numupb, Q1x,nupb)
mul(ndy,nupb, cosphi,numupb, tmp1,numupb)
add(Py,nupb, tmp1,numupb, Q1y,nupb)
mul(ndz,nupb, cosphi,numupb, tmp1,numupb)
add(Pz,nupb, tmp1,numupb, Q1z,nupb)

// Calculate Q2 = Q1 + (P2-P1)*invindex
sub(P2x,nupb, P1x,nupb, tmp1,numupb)
mul(tmp1,numupb, invindex,nupb, tmp2,numupb)
add(Q1x,nupb, tmp2,numupb, Q2x,nupb) // Q2x = Q1x + (P2x-P1x)*invindex

sub(P2y,nupb, P1y,nupb, tmp1,numupb)
mul(tmp1,numupb, invindex,nupb, tmp2,numupb)
add(Q1y,nupb, tmp2,numupb, Q2y,nupb) // Q2y = Q1y + (P2y-P1y)*invindex

sub(P2z,nupb, P1z,nupb, tmp1,numupb)
mul(tmp1,numupb, invindex,nupb, tmp2,numupb)
add(Q1z,nupb, tmp2,numupb, Q2z,nupb) // Q2z = Q1z + (P2z-P1z)*invindex

sub(Q2x,nupb, Px,nupb, outdx,nupb)
sub(Q2y,nupb, Py,nupb, outdy,nupb)
sub(Q2z,nupb, Pz,nupb, outdz,nupb)
normalize(outdir,nupb)

RESULTIS TRUE
}

```

The next function, `reflect`, deals with the reflection of a ray by the silvered surface of the mirror.

Its arguments specifying the inward direction (`indir`) of a ray, the coordinates of the intersection point (`P`) on a spherical surface, and `c` is the z coordinate of the centre of the sphere. These quantities allow it to calculate the direction cosines of the reflected ray. The calculation is easy since the angle of reflection is equal to the angle of incidence. As in `refract` we calculate the normal at the intersection point and then $\cos \theta$ where θ is the angle of incidence. Then, as before, we construct a right angled triangle $P - A - B$ where P is the intersection point, A is the point on the incoming ray one unit from P and B is the point on the normal at a distance $\cos \theta$ from P and on the same side of the mirror as A . We then construct the point C equal to $B - (A - B) = 2B - A$. The triangle $P - C - B$ is clearly a mirror image of $P - A - B$ and they are both in the same plane, so the line $P - C$ lies in the reflected ray, giving us the required direction to place in `outdir`. The definition of `reflect` is as follows.

```

AND reflect(indir, P, c, outdir) = VALOF
{ // This computes the direction cosines of a reflected ray.
  // indir!0,indir!1,indir!2 hold the direction cosines of the in ray.
  // P!0,P!1,P!2 hold the coordinates of the intersection point on
  //           the mirror surface.
  // c           is the z coordinate of the centre of the mirror surface.
  // outdir!0,outdir!1,outdir!2 will hold the direction cosines
  //           of the reflected ray.
  // All the numbers above have upperbound nupb.
  // The result is TRUE if the reflection is successful.
  LET costheta = VEC numupb

  LET indx = indir!0 // The direction cosines of the incident ray.
  AND indy = indir!1
  AND indz = indir!2

  LET Px = P!0 // The coordinates of the entry point.
  AND Py = P!1
  AND Pz = P!2

  LET outdx = outdir!0 // To hold the out direction cosines.
  AND outdy = outdir!1
  AND outdz = outdir!2

  LET Nx = VEC nupb // The direction cosines of the normal
  AND Ny = VEC nupb // at the intersection point P.
  AND Nz = VEC nupb

  LET Ax = VEC nupb // The coordinates of the point on the

```

```

AND Ay = VEC nupb // inray one unit from P
AND Az = VEC nupb

LET Bx = VEC nupb // The coordinates of the point on the
AND By = VEC nupb // the normal costheta from P
AND Bz = VEC nupb

LET Cx = VEC nupb // The coordinates of the point on the
AND Cy = VEC nupb // reflected ray one unit from P.
AND Cz = VEC nupb // Note B is the mid point of A and C.

AND tmp1 = VEC numupb

// Compute the normal.
copy(Px,nupb,      Nx,nupb)
copy(Py,nupb,      Ny,nupb)
sub(Pz,nupb, c,nupb, Nz,nupb)
normalize(@Nx,nupb)

// Calculate the coordinates of A = P - indir
sub(Px,nupb, indx,nupb, Ax,nupb)
sub(Py,nupb, indy,nupb, Ay,nupb)
sub(Pz,nupb, indz,nupb, Az,nupb)

// Calculate the coordinated of B = point - N * costheta
inprod(indir,nupb, @Nx,nupb, costheta,numupb)
mul(Nx,nupb, costheta,numupb, tmp1,numupb)
sub(Px,nupb, tmp1,numupb, Bx,nupb)
mul(Ny,nupb, costheta,numupb, tmp1,numupb)
sub(Py,nupb, tmp1,numupb, By,nupb)
mul(Nz,nupb, costheta,numupb, tmp1,numupb)

sub(Pz,nupb, tmp1,numupb, Bz,nupb)

// Calculate the coordinates of C = 2B - A
mulbyk(2, Bx,nupb)
mulbyk(2, By,nupb)
mulbyk(2, Bz,nupb)
sub(Bx,nupb, Ax,nupb, Cx,nupb)
sub(By,nupb, Ay,nupb, Cy,nupb)
sub(Bz,nupb, Az,nupb, Cz,nupb)

// Calculate the direction of the reflected ray normalize(C - P)

sub(Cx,nupb, Px,nupb, outdx,nupb)

```

```

sub(Cy,nupb, Py,nupb, outdy,nupb)
sub(Cz,nupb, Pz,nupb, outdz,nupb)
normalize(outdir,nupb)

RESULTIS TRUE
}

```

The function `raytrace` follows a ray from its initial refraction at the front surface of the objective lens through the other refractions and the reflection in the mirror until it finally leaves the front surface of the mirror and hits the focal plane at $z = 0$. The x and y coordinates in the focal plane are copied to the arguments `focalx` and `focaly`. The function, although quite long, is simple using `intersect`, `refract` and `reflect` where needed as the ray passes through the five spherical surfaces.

```

AND raytrace(indir, P, colour, focalx, focaly) = VALOF
{ // Trace a ray all the way through the telescope
  // indir!0,indir!1,indir!2 are the direction cosines of the
  //                               incoming ray.
  // P!0,P!1,P!2 are the coordinates of a point on the incoming ray.
  // colour is either Blue or Red.
  // focalx,focaly are the coordinates in the focal plane resulting
  //                               from the incoming ray.
  // The result is TRUE if the raytracing was successful.

  // The ray passes through the following
  // (1) the front surface of the objective lens, crown glass
  // (2) the rear surface of the objective lens
  // (3) the front surface of the mirror, flint glass
  // (4) the reflective surface of the mirror
  // (5) back through the front surface of the mirror

  LET t1    = VEC nupb
  LET t2    = VEC nupb
  LET tmp1  = VEC numupb
  LET tmp2  = VEC numupb
  LET tmp3  = VEC numupb

  LET indx  = VEC nupb // Private in direction cosines
  AND indy  = VEC nupb
  AND indz  = VEC nupb

  LET inptx = VEC nupb // Point on an in ray
  AND inpty = VEC nupb
  AND inptz = VEC nupb
}

```

```

LET x      = VEC nupb // For intersection points
AND y      = VEC nupb
AND z      = VEC nupb

LET outdx  = VEC nupb // Direction cosines of an out ray.
AND outdy  = VEC nupb
AND outdz  = VEC nupb

AND invindex = ? // The inverse of the refractive index of
                // the current surface depending on colour
                // and crown or flint glass.

// Front surface of the objective lens

copy(indir!0,nupb, indx,nupb) // In direction to front surface of objective
copy(indir!1,nupb, indy,nupb)
copy(indir!2,nupb, indz,nupb)

copy(P!0,nupb, inptx,nupb) // A point on the incident ray.
copy(P!1,nupb, inpty,nupb)
copy(P!2,nupb, inptz,nupb)

UNLESS intersect(@indx, @inptx, C1, R1, t1, t2) RESULTIS FALSE

// Select the negative root
IF t2!0 DO copy(t2,nupb, t1,nupb)

IF tracing DO
  writef("*nObjective front surface intersection point (x,y,z) is:*n")

mul(indx,nupb, t1,nupb, tmp1,numupb)
add(inptx,nupb, tmp1,numupb, x,nupb)
IF tracing DO
{ writef("x=          "); prnum(x,8) }

mul(indy,nupb, t1,nupb, tmp1,numupb)
add(inpty,nupb, tmp1,numupb, y,nupb)
IF tracing DO
{ writef("y=          "); prnum(y,8) }

mul(indz,nupb, t1,nupb, tmp1,numupb)
add(inptz,nupb, tmp1,numupb, z,nupb)
IF tracing DO
{ writef("z=          "); prnum(z,8) }

```

```

// Apply Snell's law to obtain the transmitted direction

// indx,indy,indz hold the direction cosines of the in ray.
// outdir will hold the direction cosines of the out ray.
// (x,y,z) are the coordinates of the entry point on the
//      objective lens front surface.
// C1 is the z coordinate of the centre of the lens front surface.
// invindex is the inverse of the refractive index.

// Set the air to glass refractive index for crown glass
// depending on the colour.
invindex := colour=Blue -> crownblueinvindex, crownredinvindex

refract(@indx, @x, C1, invindex, @outdx)

// Now deal with the rear surface of the objective lens.

copy(outdx,nupb, indx,nupb) // Out ray of front surface becomes
copy(outdy,nupb, indy,nupb) // the in ray of the rear surface.
copy(outdz,nupb, indz,nupb)

copy(x,nupb, inptx,nupb) // The intersection point on the front surface
copy(y,nupb, inpty,nupb) // is a point on the in ray of the rear surface.
copy(z,nupb, inptz,nupb)

UNLESS intersect(@indx, @inptx, C2, R2, t1, t2) RESULTIS FALSE

// Select the positive root.
UNLESS t2!0 DO copy(t2,nupb, t1,nupb)
//writef("t1=      "); prnum(t1,nupb)

IF tracing DO
  writef("*nObjective rear surface intersection point (x,y,z) is:*n")

mul(indx,nupb, t1,nupb, tmp1,numupb)
add(inptx,nupb, tmp1,numupb, x,nupb)
IF tracing DO
{ writef("x=      "); prnum(x,8) }

mul(indy,nupb, t1,nupb, tmp1,numupb)
add(inpty,nupb, tmp1,numupb, y,nupb)
IF tracing DO
{ writef("y=      "); prnum(y,8) }

```



```

mul(indz,nupb, t1,nupb, tmp1,numupb)
add(inptz,nupb, tmp1,numupb, z,nupb)
IF tracing DO
{ writef("z=          "); prnum(z,8) }

// Set the inverse of the glass to air refractive index for
// crown glass depending on the colour.
invindex := colour=Blue -> crownblueindex, crownredindex

// Calculate the new out direction.
refract(@indx, @x, C2, invindex, @outdx)

// Now deal with the front surface of the mirror.

copy(outdx,nupb, indx,nupb)
copy(outdy,nupb, indy,nupb)
copy(outdz,nupb, indz,nupb)

copy(x,nupb, inptx,nupb) // The intersection point on the
copy(y,nupb, inpty,nupb) // rear surface of the objective lens.
copy(z,nupb, inptz,nupb)

UNLESS intersect(@indx, @inptx, C3, R3, t1, t2) RESULTIS FALSE

// Select the positive root, one of t1 or t2 is positive.
IF t1!0 DO copy(t2,nupb, t1,nupb)

IF tracing DO
  writef("The mirror front surface intersection point (x,y,z) is:n")

mul(indx,nupb, t1,nupb, tmp1,nupb)
add(inptx,nupb, tmp1,nupb, x,nupb) // x = inptx + t1*indx
IF tracing DO
{ writef("x=          "); prnum(x, 8) }

mul(indy,nupb, t1,nupb, tmp1,nupb)
add(inpty,nupb, tmp1,nupb, y,nupb) // y = inpty + t1*indy
IF tracing DO
{ writef("y=          "); prnum(y, 8) }

mul(indz,nupb, t1,nupb, tmp1,nupb)
add(inptz,nupb, tmp1,nupb, z,nupb) // z = inptz + t1*indz
IF tracing DO
{ writef("z=          "); prnum(z, 8) }

```

```

// Calculate the distance from the z axis.
mul(x,nupb, x,nupb, tmp1,numupb) //tmp1 = x^2
mul(y,nupb, y,nupb, tmp2,numupb) //tmp2 = y^2
add(tmp1,numupb, tmp2,numupb, tmp3,numupb) // tmp3 = x^2 + y^2
sqrt(tmp3,numupb, tmp1,numupb) // tmp1 = the radius

IF numcmp(tmp1,numupb, MirrorRadius,nupb) > 0 DO
    copy(tmp1,numupb, MirrorRadius,nupb)

IF tracing DO
{ writef("\nMirror radius= "); prnum(MirrorRadius,8) }

// Set the air to glass refractive index for flint glass
// depending on the colour.
invindex := colour=Blue -> flintblueinvindex, flintredinvindex

// Calculate the new out direction
refract(@indx, @x, C3, invindex, @outdx)

// Now deal with the reflecting surface of the mirror.

copy(outdx,nupb, indx,nupb) // Out direction of the front surface is
copy(outdy,nupb, indy,nupb) // the in direction to the silvered surface.
copy(outdz,nupb, indz,nupb)

copy(x,nupb, inptx,nupb) // The intersection point on the front
copy(y,nupb, inpty,nupb) // surface of the mirror.
copy(z,nupb, inptz,nupb)

UNLESS intersect(@indx, @inptx, C4, R4, t1, t2) RESULTIS FALSE

// Select the positive root. One of t1 or t2 is positive.
IF t1!0 DO copy(t2,nupb, t1,nupb)

IF tracing DO
    writef("\nThe mirror reflective surface intersection point (x,y,z) is:\n")

mul(indx,nupb, t1,nupb, tmp1,nupb)
add(inptx,nupb, tmp1,nupb, x,nupb) // x = inptx + t1*indx
IF tracing DO
{ writef("x=          "); prnum(x, 8) }

mul(indy,nupb, t1,nupb, tmp1,nupb)
add(inpty,nupb, tmp1,nupb, y,nupb) // y = inpty + t1*indy

```

```

IF tracing DO
{ writef("y=          "); prnum(y, 8) }

mul(indz,nupb, t1,nupb, tmp1,nupb)
add(inptz,nupb, tmp1,nupb, z,nupb) // y = inptz + t1*indz
IF tracing DO
{ writef("z=          "); prnum(z, 8) }

// Calculate the new out direction.
reflect(@indx, @x, C4, @outdx)

// Now deal with the front surface of the mirror again.

copy(outdx,nupb, indx,nupb)
copy(outdy,nupb, indy,nupb)
copy(outdz,nupb, indz,nupb)

copy(x,nupb, inptx,nupb) // the intersection point on the front surface
copy(y,nupb, inpty,nupb)
UNLESS intersect(@indx, @inptx, C3, R3, t1, t2) RESULTIS FALSE

// Select the smaller root
IF numcmp(t2,nupb, t1,nupb)<0 DO copy(t2,nupb, t1,nupb)

IF tracing DO
  writef("*nThe mirror front surface intersection point (x,y,z) is:*n")

mul(indx,nupb, t1,nupb, tmp1,nupb)
add(inptx,nupb, tmp1,nupb, x,nupb)
IF tracing DO
{ writef("x=          "); prnum(x, 8) }

mul(indy,nupb, t1,nupb, tmp1,nupb)
add(inpty,nupb, tmp1,nupb, y,nupb)
IF tracing DO
{ writef("y=          "); prnum(y,8) }

mul(indz,nupb, t1,nupb, tmp1,nupb)
add(inptz,nupb, tmp1,nupb, z,nupb)
IF tracing DO
{ writef("z=          "); prnum(z,8) }

// Set the inverse of the glass to air refractive index for flint glass
// depending on the colour.

```

```

inindex := colour=Blue -> flintblueindex, flintredindex

// Calculate the new out direction
refract(@indx, @x, C3, inindex, @outdx)

TEST iszero(outdz,nupb)
THEN { // In the exceptional case where outdz is zero,
      // focalx and focaly are just x and y.
      copy(x,nupb, focalx,nupb)
      copy(y,nupb, focaly,nupb)
    }
ELSE { div(z,nupb, outdz,nupb, tmp1,numupb)
      mul(outdx,nupb, tmp1,numupb, tmp2,numupb)
      sub(x,nupb, tmp2,numupb, focalx,nupb)
      mul(outdy,nupb, tmp1,numupb, tmp2,numupb)
      sub(y,nupb, tmp2,numupb, focaly,nupb)
    }

RESULTIS TRUE
}

```

The next two functions allocate cleared vectors with a specified upperbound.

```

AND newvec(upb) = VALOF
{ LET p = spacep - upb - 1
  IF p<spacev DO
  { writef("*nMore space needed*n")
    abort(999)
    RESULTIS 0
  }
  spacep := p
  FOR i = 0 TO nupb DO p!i := 0
  RESULTIS p
}

AND newnum(upb) = newvec(upb)

```

The next function, `telescope`, attempts to optimise the design of the telescope by successively making small changes to R1, R2, R3 and R4, preferring the settings that reduce the size of the scattering of points resulting from rays entering the objective lens at different positions. Three point sources are chosen, one on the axis of the telescope and the other two at about 1/8 and 1/4 degree off the axis (in the y direction). Rays of both blue and red light are used. If the optics of the telescope were perfect and if the focal length was 1000mm, then the three point sources would produce single point images on the focal plane at

about $x = 0$, $z = 0$ and $y = 0$, -2.0833 and -4.1666 mm. The program traces each ray through the telescope measuring its distance from its focal point. The largest of these distances is placed in `spotsize`. Circles of this radius centred at each of the three focal points will enclose all the scattered points. How the program selects better values for R1 to R4 is explained later.

The function starts as follows.

```

AND telescope() BE
{ LET tmp1 = VEC nupb
  AND tmp2 = VEC nupb
  AND tmp3 = VEC nupb
  AND tmp4 = VEC nupb
  AND tmp5 = VEC nupb

  LET delta = VEC nupb          // Current change in a radius value
  LET initdelta = VEC nupb      // Current initial setting of delta
  LET failcount = -1           // Unset

  // The idea is to try changing each radius R1 to R4 by a small amount delta
  // either positive or negative. The distance between the average y coordinates
  // of an image spot and the theoretical position of its centre assuming a
  // focal length of 1000mm is placed in dist. spotsize+dist is placed in
  // spotvalue giving a measure of how good the optics are. If spotvalue reduces,
  // the current delta values are doubled and a new setting of R1 to R4 tried,
  // otherwise start again with a new set of small random delta values, and
  // start again.

  // Every time the sizes of the spots reduce, the file catageometry.txt is
  // written with the new radii R1 to R4.

  // If the file catageometry.txt exists, it is used to set the initial values
  // of R1 to R4.

  // Typically every time cataopt runs these radii are improved.

  // Directions 0, 1 and 2 are small angles in the y-z plane
  // used to generate test in rays.

  dir0cx := newnum(nupb) // Direction parallel to the telescope axis
  dir0cy := newnum(nupb)
  dir0cz := newnum(nupb)
  settok(0, dir0cx,nupb)
  settok(0, dir0cy,nupb)
  settok(1, dir0cz,nupb)

```

```

dir1cx := newnum(nupb)
dir1cy := newnum(nupb)
dir1cz := newnum(nupb)
settok( 0, dir1cx,nupb) // Direction about 1/8 degree off the telescope axis.
settok( -1, dir1cy,nupb) // Note that 1 in 60 is about 1 degree
settok(480, dir1cz,nupb) // so 1 in 480 is about 1/8 degree
normalize(@dir1cx,nupb)

dir2cx := newnum(nupb)
dir2cy := newnum(nupb)
dir2cz := newnum(nupb)
settok( 0, dir2cx,nupb) // Direction about 1/4 degree off the telescope axis.
settok( -1, dir2cy,nupb) // This is a field of view about the size of the moon.
settok(240, dir2cz,nupb) // Note that 1 in 60 is about 1 degree
                        // so 1 in 240 is about 1/4 degree
normalize(@dir2cx,nupb)

Arad := newnum(nupb) // Radius of the A circle in the objective
settok(50, Arad,nupb)
Brad := newnum(nupb) // Radius of the B circle in the objective
settok(25, Brad,nupb)

R1 := newnum(nupb) // Objective lens front radius
prevR1 := newnum(nupb)
C1 := newnum(nupb) // Centre of objective lens front
R2 := newnum(nupb) // Objective lens rear radius
prevR2 := newnum(nupb)
C2 := newnum(nupb) // Centre of objective lens rear surface
R3 := newnum(nupb) // Concave mirror front radius
prevR3 := newnum(nupb)
C3 := newnum(nupb) // Centre of concave mirror front surface
R4 := newnum(nupb) // Concave mirror silvered surface radius
prevR4 := newnum(nupb)
C4 := newnum(nupb) // Centre of concave mirror silvered surface
T1 := newnum(nupb) // Objective thickness
T2 := newnum(nupb) // Mirror thickness

MirrorRadius := newnum(nupb) // Radius of mirror

D := newnum(nupb) // The distance between the objective and mirror.
                // This is typically 700mm.
F := newnum(nupb) // The z coordinate of the focus plane, typically F=0
                // This typically give a focal length of 1000mm.

Inx := newnum(nupb) // The direction cosines of an in going ray to a

```

```

Iny := newnum(nupb) // lens or mirror surface.
Inz := newnum(nupb)

Outx := newnum(nupb) // The direction cosines of an out going ray to a
Outy := newnum(nupb) // lens or mirror surface.
Outz := newnum(nupb)

outdircx := newnum(nupb)
outdircy := newnum(nupb)
outdircz := newnum(nupb)

deltaR1 := newnum(nupb) // Used to make small changes to R1 to R4
deltaR2 := newnum(nupb)
deltaR3 := newnum(nupb)
deltaR4 := newnum(nupb)

root2 := newnum(nupb)
one := newnum(nupb)

// Allocate numbers for the refractive indexes
crownblueindex := newnum(nupb)
crownredindex := newnum(nupb)
flintblueindex := newnum(nupb)
flintredindex := newnum(nupb)

// Allocate numbers for the inverse refractive indexes
crownblueinvindex := newnum(nupb)
crownredinvindex := newnum(nupb)
flintblueinvindex := newnum(nupb)
flintredinvindex := newnum(nupb)

spot0vx := newvec(16+16+2-1) // Space for points of spot0
spot0vy := newvec(16+16+2-1)
spot1vx := newvec(16+16+2-1) // Space for points of spot1
spot1vy := newvec(16+16+2-1)
spot2vx := newvec(16+16+2-1) // Space for points of spot2
spot2vy := newvec(16+16+2-1)

// Note that for spot0 the x coordinates in the focal plane
// are held in spot0vx. The table of subscripts is as follows

// 0 to 7 A circle Blue dots
// 8 to 15 A circle Red dots
// 16 to 23 B circle Blue dots
// 24 to 31 B circle Red dots

```

```

// 32      C ray   Blue dot
// 33      C ray   Red  dot

// spot0vy holds the y coordinates of spot0 dots

// spot1vx, spot1vy, spot2vx and spot2vy hold the coordinates
// of the spot1 and spot2 Blue and Red dots

FOR i = 0 TO 16+16+2-1 DO
{ // Allocate space for all the spot dot coordinates
  spot0vx!i := newnum(nupb)
  spot0vy!i := newnum(nupb)
  spot1vx!i := newnum(nupb)
  spot1vy!i := newnum(nupb)
  spot2vx!i := newnum(nupb)
  spot2vy!i := newnum(nupb)
}

bestspotsize := newnum(nupb)
spotsize     := newnum(nupb)
dist         := newnum(nupb)
bestdist     := newnum(nupb)
bestspotvalue := newnum(nupb)
spotvalue    := newnum(nupb)

UNLESS spotsize DO
{ writef("More space needed*n")
  abort(999)
  RETURN
}

```

The program continues as follows initialising several global values such as T1 and T2 the thicknesses of the objective lens and mirror measured at their centres. D is set to 700, the z position of the mirror. The square root of 2 is placed in `root2` and a high precision representation of the constant 1 is placed in `one`. The refractive indices for blue and red light for crown and flint glass are placed in suitable variables, and it is also convenient to hold the inverse versions of these values. The program goes on to set well chosen initial values to the radii of the lens and mirror surfaces in R1 to R4. These settings cause each of the selected rays to hit the focal plane at a distance no greater than 0.0217mm from the theoretical centre of the image for a point source from its direction.

```

// All numbers have been created successfully

// Set the unchanging geometry of the telescope

```



```

settok( 4, T1,nupb) // Objective lens thickness 4mm at centre.
settok( 4, T2,nupb) // Mirror thickness 4mm at centre.
settok(700, D,nupb) // z coordinate of the mirror silvered surface

settok(2, tmp1,nupb)
sqrt(tmp1,nupb, root2,nupb)

settok(1, one,nupb)

// Refractive indices.
// The objective glass is crown and the mirror glass is flint.

//
//          crown      flint
// blue 486 nm  1.51690  1.6321
// red  640 nm  1.50917  1.6161

str2num("1.51690", crownblueindex,nupb)
str2num("1.50917", crownredindex,nupb)
str2num("1.6321",  flintblueindex,nupb)
str2num("1.6161",  flintredindex,nupb)

inv(crownblueindex,nupb, crownblueinvindex,nupb)
inv(crownredindex,nupb,  crownredinvindex,nupb)
inv(flintblueindex,nupb, flintblueinvindex,nupb)
inv(flintredindex,nupb,  flintredinvindex,nupb)

IF tracing DO
{ writef("crownblueindex=   "); prnum(crownblueindex, 6)
  writef("crownredindex=   "); prnum(crownredindex, 6)
  writef("flintblueindex=  "); prnum(flintblueindex, 6)
  writef("flintredindex=    "); prnum(flintredindex, 6)

  writef("crownblueinvindex= "); prnum(crownblueinvindex, 6)
  writef("crownredinvindex=  "); prnum(crownredinvindex, 6)
  writef("flintblueinvindex= "); prnum(flintblueinvindex, 6)
  writef("flintredinvindex=  "); prnum(flintredinvindex, 6)
}

// Initialize the setting of the lens and mirror surface radii.
// These are overwritten if file catagemetry.txt exists.

// It seems that the initial settings of R1 to R4 often cause
// the iterations to lead to a false minimum. So some
// experimentation was needed before a good result was obtained.

```

```

//str2num("5000", R1,nupb) // Objective front surface radius
//str2num("5000", R2,nupb) // Objective rear surface radius
//str2num("1100", R3,nupb) // Radius of mirror front surface
//str2num("1200", R4,nupb) // Radius of mirror silvered surface
// This give a spot size of about 0.0173mm after many hours

str2num("+0.1537 9603 6301 4326 5100 0000 0000 E1", R1,nupb)
str2num("+0.4978 7269 7214 4032 0700 0000 0000 E1", R2,nupb)
str2num("+0.0926 7191 6585 7604 6700 0000 0000 E1", R3,nupb)
str2num("+0.1505 7199 0416 5610 7700 0000 0000 E1", R4,nupb)
// This give a spot radius of about 0.0173mm

//str2num("+0.1545 1166 8077 8501 2000 0000 0000 E1", R1,nupb)
//str2num("+0.4969 1626 0425 6302 7000 0000 0000 E1", R2,nupb)
//str2num("+0.0946 9427 9298 7956 8000 0000 0000 E1", R3,nupb)
//str2num("+0.1523 9989 0724 6298 1000 0000 0000 E1", R4,nupb)
// This give a spot radius of about
// 0.0217mm for A2 and 0.0153mm for A1 and 0.0082mm for A0
// The Airy disc radius is 0.00671mm

// To show that this is close to the theoretical optimum for a
// telescope with an aperture of 100m consider the following.

// Light is electromagnetic radiation but, unlike radio waves
// which have wave lengths measured in metres, visible light
// has a wave length measured in nano-metres. Blue light is
// typically 486nm and red light is about 640nm.

// If we consider a point source of light with a wave length of
// 550nm at infinity on the axis of a optically perfect telescope,
// rays passing through every point the objective lens will be in
// phase when they reach the focus point. As a result of
// diffraction the image is not a tiny spot but a rather larger
// spot surrounded by light and dark rings. A point of the
// innermost dark ring is where the path lengths from opposite
// edges of the objective lens differ by about one wave length of
// the colour being considered. This is because rays being received
// at this point are out of phase with other rays and so are
// partially cancelled. The size of the bright spot at the centre
// is thus somewhat smaller than the size of the innermost dark
// diffraction ring. By applying simple geometry we can estimate
// the radius of the innermost diffraction ring as  $(1000/100)*(550/2)$ 
// which is about 2750nm. This is  $2750*10^{-9}m = 2750*10^{-6}mm$ 
// = 0.00275mm. The diameter of the bright spot will thus be about

```

```
// 0.0055mm. Since our best spot size of 0.0093mm is not much
// larger than this, so we are close to the theoretical limit
// of a telescope with an aperture of 100mm.

// As a rule of thumb the maximum usable magnification of a
// telescope is between about 1 and 1.2 times its aperture in
// millimetres. In practice it is far less that because of
// the disturbance caused the atmosphere.
```

The next part of the program checks if the file `catageometry.txt` exists, creating it if necessary using `wrgeometry()`. It then sets `factor`, `R1`, `R2`, `R3` and `R4` from the values specified in this file.

```
factor := 5          // A power of ten
                    // The initial values of the deltas are random
                    // integers in the range 0 to 9999 which are then divided
                    // by 10^factor.
                    // factor was incremented every time no improvement
                    // is made after 300 iterations.
                    // The delta values are doubled every time spotvalue
                    // reduces.
                    // Every time an improvement is made, factor, R1, R2, R3
                    // and R4 are written to the file catageometry.txt.
                    // If this file exists it is used to set the starting
                    // values the next time cataopt is run.

geometrystream := findinput("catageometry.txt")

UNLESS geometrystream DO
{ writef("Calling wrgeometry()*n")
  wrgeometry()
  geometrystream := findinput("catageometry.txt")
}

IF geometrystream DO
{ // File catageometry.txt exists so update factor, factor, R1, R2, R3 and R4
  // from values in this file.
  selectinput(geometrystream)

  factor := readn()
  rdch()

  readline(currentline)
  str2num(currentline, R1,nupb)
```

```

    readline(currentline)
    str2num(currentline, R2,nupb)

    readline(currentline)
    str2num(currentline, R3,nupb)

    readline(currentline)
    str2num(currentline, R4,nupb)

    endstream(geometrystream)

    writef("\nInitial state set from file catageometry.txt*\n*\n")
}

IF initfactor>0 DO factor := initfactor

writef("factor = %n*\n", factor)
writef("R1=      "); prnum(R1, 8)
writef("R2=      "); prnum(R2, 8)
writef("R3=      "); prnum(R3, 8)
writef("R4=      "); prnum(R4, 8)

settok(100, bestspotsize,nupb) // Unset the best spot size
settok( 0, dist,nupb)          // Unset dist
settok( 9, bestdist,nupb)     // Unset bestdist
settok( 99, bestspotvalue,nupb) // Unset bestspotvalue

setzero(spotsize,nupb)
setzero(dist,nupb)
setzero(spotvalue,nupb)

setzero(deltaR1,nupb) // This causes the first setting of
setzero(deltaR2,nupb) // the spotsize to correspond to the
setzero(deltaR3,nupb) // initial setting of R1 to R4 before
setzero(deltaR4,nupb) // any deltas are applied.
reduced := TRUE

again: // Enter here if R1 to R4 have their initial values or
      // have values that improved the gemometry of the telescope.

// Save current values of R1 to R4
copy(R1,nupb, prevR1,nupb)
copy(R2,nupb, prevR2,nupb)
copy(R3,nupb, prevR3,nupb)

```

```

copy(R4,nupb, prevR4,nupb)

// prevR1 to prevR4 are the best values so far.

newdelta:

TEST reduced
THEN { // Previous setting of the delta values caused an improvement
      // so double them.
      //writef("nreduced=TRUE so double the delta values*n")
      mulbyk(2, deltaR1,nupb)
      mulbyk(2, deltaR2,nupb)
      mulbyk(2, deltaR3,nupb)
      mulbyk(2, deltaR4,nupb)
    }
ELSE { // The previous setting, if any, made no improvement
      // so choose a new random setting, ensuring that
      // deltaR3 > deltaR4
      LET k = factor

      //writef("nChoosing a new random setting of the delta values*n")
      settok((randno(9999)-5000) | 1, deltaR1,nupb)
      settok((randno(9999)-5000) | 1, deltaR2,nupb)
      settok((randno(9999)-5000) | 1, deltaR3,nupb)
      settok((randno(9999)-5000) | 1, deltaR4,nupb)
      // Note that "| 1" above ensures all the deltas are nonzero.

      // 70% of the time only change R1 and R2 or R3 and R4.
      IF randno(101)<=70 DO
      TEST randno(101)<=50
      THEN { setzero(deltaR1,nupb)
            setzero(deltaR2,nupb)
          }
      ELSE { setzero(deltaR3,nupb)
            setzero(deltaR4,nupb)
          }

      // Divide the delta values by 10^factor

      IF k>=4 DO
      { LET e = k/4
        // Divide each delta by 10000^e
        deltaR1!1 := deltaR1!1 - e
        deltaR2!1 := deltaR2!1 - e
        deltaR3!1 := deltaR3!1 - e
      }
    }

```

```

    deltaR4!1 := deltaR4!1 - e
    k := k MOD 4
}

// Divide each delta by 10^k
UNTIL k<=0 DO
{ divbyk(10, deltaR1,nupb)
  divbyk(10, deltaR2,nupb)
  divbyk(10, deltaR3,nupb)
  divbyk(10, deltaR4,nupb)
  k := k-1
}
}

// Add the delta values to the radii.
add(deltaR1,nupb, prevR1,nupb, R1,nupb)
add(deltaR2,nupb, prevR2,nupb, R2,nupb)
add(deltaR3,nupb, prevR3,nupb, R3,nupb)
add(deltaR4,nupb, prevR4,nupb, R4,nupb)

IF R1!0 | R2!0 | R3!0 | R4!0 DO
{ // One of the radii has become negative
  writef("One of R1 to R4 has become negative, so choose a different delta*n")
  writef("R1= "); prnum(R1, 8)
  writef("R2= "); prnum(R2, 8)
  writef("R3= "); prnum(R3, 8)
  writef("R4= "); prnum(R4, 8)
  failcount := failcount+1
  abort(9999)
  GOTO newdelta
}

// Insist that R3 is greater than R4
IF numcmp(R3,nupb, R4,nupb) > 0 DO
{ failcount := failcount+1
  writef("R3 is greater than R4*n")
  writef("R3= "); prnum(R3, 8)
  writef("R4= "); prnum(R4, 8)
abort(1000)
  failcount := failcount+1
  GOTO newdelta
}

// Initialize the focal plane image

```

```

fillsurf(c_gray)

setcolour(c_black)
plotf(10,310, "spotmag = %n", spotmag)
plotf(10,290, "factor = %n", factor)

{ LET n, f1, f2 = 0, 0, 0
  IF dist!1= 1 DO n, f1, f2 := dist!2, dist!3, dist!4
  IF dist!1= 0 DO n, f1, f2 :=      0, dist!2, dist!3
  IF dist!1=-1 DO n, f1, f2 :=      0,      0, dist!2
  plotf(10,270, "dist =%i2.%z4 %z4 mm", n,f1, f2)
  n, f1, f2 := 0, 0, 0
  IF bestdist!1= 1 DO n, f1, f2 := bestdist!2, bestdist!3, bestdist!4
  IF bestdist!1= 0 DO n, f1, f2 :=      0, bestdist!2, bestdist!3
  IF bestdist!1=-1 DO n, f1, f2 :=      0,      0, bestdist!2
  plotf(10,250, "best =%i2.%z4 %z4 mm", n,f1, f2)
}

plotf(centrex-85,110, "R1      %i4.%z4 %z4 %z4 mm*n",
      R1!2, R1!3, R1!4, R1!5)
plotf(centrex-85, 90, "R2      %i4.%z4 %z4 %z4 mm*n",
      R2!2, R2!3, R2!4, R2!5)
plotf(centrex-85, 70, "R3      %i4.%z4 %z4 %z4 mm*n",
      R3!2, R3!3, R3!4, R3!5)
plotf(centrex-85, 50, "R4      %i4.%z4 %z4 %z4 mm*n",
      R4!2, R4!3, R4!4, R4!5)

IF spotsize!1=1 TEST spotsize!2>9
THEN plotf(centrex-85, 30, "Spot size  %i4.%z4 %z4 %z4 mm",
          spotsize!2, spotsize!3, spotsize!4, spotsize!5)
ELSE plotf(centrex-85, 30, "Spot size %n.%z4 %z4 %z4 %z4 mm",
          spotsize!2, spotsize!3, spotsize!4, spotsize!5, spotsize!6)
IF spotsize!1=0 DO
  plotf(centrex-85, 30, "Spot size 0.%z4 %z4 %z4 %z4 mm",
        spotsize!2, spotsize!3, spotsize!4, spotsize!5)
IF spotsize!1=-1 DO
  plotf(centrex-85, 30, "Spot size 0.0000 %z4 %z4 %z4 mm",
        spotsize!2, spotsize!3, spotsize!4)

IF bestspotsize!1=1 TEST bestspotsize!2>9
THEN plotf(centrex-85, 10, "Spot size  %i4.%z4 %z4 %z4 mm",
          bestspotsize!2, bestspotsize!3, bestspotsize!4, bestspotsize!5)
ELSE plotf(centrex-85, 10, "Spot size %n.%z4 %z4 %z4 %z4 mm",
          bestspotsize!2, bestspotsize!3, bestspotsize!4,
          bestspotsize!5, bestspotsize!6)

```

```

IF bestspots!1=0 DO
  plotf(centrex-85, 10, "Best size 0.%z4 %z4 %z4 %z4 mm",
        bestspots!2, bestspots!3, bestspots!4, bestspots!5)
IF bestspots!1=-1 DO
  plotf(centrex-85, 10, "Best size 0.0000 %z4 %z4 %z4 mm",
        bestspots!2, bestspots!3, bestspots!4)

setcolour(c_black)
moveto(0, centrey)
drawby( screenxsize, 0)
moveto(centrex, 0)
drawby(0, screensize)

updatescreen()

// Calculate the values that depend on the radii R1 to R4

// Calculate the z coordinate of the objective front surface centre
copy(T1,nupb, tmp1,nupb) // The thickness of the objective lens
divbyk(2, tmp1,nupb) // Half of its thickness

sub(R1,nupb, tmp1,nupb, C1,nupb) // Centre of the objective front surface.

sub(tmp1,nupb, R2,nupb, C2,nupb) // Centre of the objective rear surface.

sub(D,nupb, T2,nupb, tmp1,nupb)
sub(tmp1,nupb, R3,nupb, C3,nupb) // Centre of mirror front surface

sub( D,nupb, R4,nupb, C4,nupb) // Centre of mirror silvered surface

```

The optimisation process involves tracing a selection of rays through the telescope that originate from up to three point sources and entering the telescope at different positions on the objective lens. Each ray arrives as a dot on the focal plane. The program tries to minimise the scattering of these dots. The x and y coordinates of each dot is saved in the vectors such as `spot0vx` and `spot0vy`. There are a total of 34 rays for each of the three point sources, but normally, to improve the rate of convergence, only a subset of the possible rays are used. The rays are processed by calls of `doray` and normally many of these are commented out. The call `calcspotsize(spotno)` where `spotno` is 0, 1 or 2, determines the size of the image generated from each of the three directions. The coordinate vectors are initialised with x values of 100 which will never result from a valid ray to allow `calcspotsize` to ignore coordinates not resulting from calls of `doray`. The program thus continues as follows.

```

// Mark all dot coordinates as unset so that calcspotsize

```



```

// will only use those that have been defined.
FOR i = 0 TO 16+16+2-1 DO
{ // Unset image points have x set to 100.
  settok(100, spot0vx!i)
  settok(100, spot1vx!i)
  settok(100, spot2vx!i)
}

setzero(MirrorRadius,nupb)

// The rate of convergence is greatly improved by commenting
// out most of the call of doray, but at least two should be
// left in. Leaving them mostly uncommented causes a prettier
// picture to be drawn. If you leave only two call of doray,
// it is probably best to leave:
// doray(2,'A',0) and doray(2,'A',4).

// Now trace several rays through the telescope, storing the
// image dots in the focal plane coordinate vectors.

doray(0, 'A', 0)
doray(0, 'A', 1)
doray(0, 'A', 2)
doray(0, 'A', 3)
doray(0, 'A', 4)
doray(0, 'A', 5)
doray(0, 'A', 6)
doray(0, 'A', 7)

//doray(0, 'B', 0)
//doray(0, 'B', 1)
//doray(0, 'B', 2)
//doray(0, 'B', 3)
//doray(0, 'B', 4)
//doray(0, 'B', 5)
//doray(0, 'B', 6)
//doray(0, 'B', 7)

doray(0, 'C', 0)

doray(1, 'A', 0)
doray(1, 'A', 1)
doray(1, 'A', 2)
doray(1, 'A', 3)
doray(1, 'A', 4)

```

```
doray(1, 'A', 5)
doray(1, 'A', 6)
doray(1, 'A', 7)

//doray(1, 'B', 0)
//doray(1, 'B', 1)
//doray(1, 'B', 2)
//doray(1, 'B', 3)
//doray(1, 'B', 4)
//doray(1, 'B', 5)
//doray(1, 'B', 6)
//doray(1, 'B', 7)

doray(1, 'C', 0)

doray(2, 'A', 0)
doray(2, 'A', 1)
doray(2, 'A', 2)
doray(2, 'A', 3)
doray(2, 'A', 4)
doray(2, 'A', 5)
doray(2, 'A', 6)
doray(2, 'A', 7)

//doray(2, 'B', 0)
//doray(2, 'B', 1)
//doray(2, 'B', 2)
//doray(2, 'B', 3)
//doray(2, 'B', 4)
//doray(2, 'B', 5)
//doray(2, 'B', 6)
//doray(2, 'B', 7)

doray(2, 'C', 0)

IF tracing DO
{ writef("\nMirrorRadius= "); prnum(MirrorRadius,8)
  newline()
//abort(5100)
}

// Calculate spotsize and dist.

setzero(spotsize,nupb)
setzero(dist,nupb)
```

```

calcspotsize(0)
calcspotsize(1)
calcspotsize(2)

// For the current setting of R1 to R4, spotsize is now
// the size of the largest of the images from the selected
// directions, and dist is greatest distance the
// average y is from the theoretical centre of its spot.

// Set spotvalue to spotsize + dist
// It is a measure of how good the optics of the telescope is.

//writef("dist=          "); prnum(dist, 8)
//writef("spotsize=      "); prnum(spotsize, 8)

add(spotsize,nupb, dist,nupb, spotvalue,nupb)
//writef("spotsize=      "); prnum(spotsize, 8)
//writef("spotvalue=     "); prnum(spotvalue, 8)
//writef("bestspotvalue= "); prnum(bestspotvalue, 8)

// If spotvalue is smaller than bestspotvalue, the optics of
// the telescope has improved, so the current settings of
// {\tt R1} to {\tt R4} are are remembered and bestspotsize,
// bestdist and bestspotvalue updated.

TEST numcmp(spotvalue,nupb, bestspotvalue,nupb) < 0
THEN { reduced := TRUE
      writef("%i4 Spotvalue has reduced*n", iterations)

      //writef("%i4 spotvalue=      ", iterations); prnum(spotvalue,8)
      //writef("%i4 bestspotvalue= ", iterations); prnum(bestspotvalue,8)

      //writef("%i4 spotsize=      ", iterations); prnum(spotsize,8)
      //writef("%i4 bestspotsize= ", iterations); prnum(bestspotsize,8)

      //writef("%i4 dist=          ", iterations); prnum(dist,8)
      //writef("%i4 bestdist=      ", iterations); prnum(bestdist,8)

      copy(spotsize,nupb, bestspotsize,nupb)
      copy(dist,nupb, bestdist,nupb)
      copy(spotvalue,nupb, bestspotvalue,nupb)
      wrgeometry()
      iterations := iterations-1
      failcount := 0

```

```

    }
ELSE { // No improvement so re-instate the previous radii.
    reduced := FALSE
    copy(prevR1,nupb, R1,nupb)
    copy(prevR2,nupb, R2,nupb)
    copy(prevR3,nupb, R3,nupb)
    copy(prevR4,nupb, R4,nupb)
    failcount := failcount+1
    writef("%i4 This delta failed, failcount=%n*n", iterations, failcount)
    //writef("spotsizes= "); prnum(spotsizes,8)
    //writef("bestspotsizes= "); prnum(bestspotsizes,8)

    IF failcount>500 DO
    { // Make the delta values smaller
        factor := factor + 1
        IF factor > 14 RETURN // Return from telescope
        failcount := 0
        writef("*n*nSetting new factor=%n*n", factor)
        GOTO again
    }
}

IF pausing DO abort(1235)

IF iterations>0 GOTO again

fin:
}

```

The next function calculates the size of the image generated by a collection of rays taken from a point source of blue and red light from a direction specified by the argument `spotno` which is 0, 1 or 2. The size is the largest distance of a dot in the focal plane from the theoretical centre for the specified direction. The y coordinated of the centres resulting from directions 0, 1 and 2 are 0mm, -2.0833mm and -4.1866mm, respectively. The x and y coordinates of dots in the focal plane resulting from rays from direction 0 are in `spot0vx` and `spot0vy`. For directions 1 and 2, the vectors are `spot1vx` and `spot1vy`, and `spot2vx` and `spot2vy`.

```

AND calcspotsizes(spotno) BE
{ // This function finds average y coordinate for the current spot
  // placing it in avgy. It then calculates its distance from the
  // theoretical centre of the spot, dist is updated.

  // It then inspects each dot belonging to the specified spot. If

```

```

// its distance from (0,avgy) is greater than spotsize, spotsize
// is updated.

// The algorithm attempts to minimise both dist and spotsize
// placing more significance on dist since this is a measure
// of how close the focal length is to 1000mm.

LET tmp1 = VEC nupb
LET tmp2 = VEC nupb
LET tmp3 = VEC nupb
LET tmp4 = VEC nupb
LET tmp5 = VEC nupb
LET tmp6 = VEC nupb
LET avgy = VEC nupb
LET count = 0      // Count of dots in this spot
LET spotsizesq = VEC nupb

// Set the theoretical centre of the specified spot to (0,cgy).
LET cgy = spotno=0 ->
      (TABLE FALSE, 0, 0, 0000), // 0.0000 for direction 0
      spotno=1 ->
      (TABLE TRUE, 1, 2, 0833), // -2.0833 for direction 1
      (TABLE TRUE, 1, 4, 1666) // -4.1666 for direction 2
// Note that cgy has upb=3.

// Select the coordinate vectors for the specified spot
LET px = spotno=0 -> spot0vx,
      spotno=1 -> spot1vx,
      spot2vx
LET py = spotno=0 -> spot0vy,
      spotno=1 -> spot1vy,
      spot2vy
setzero(avgy,nupb)

// Calculate avgy and hence dist
FOR i = 0 TO 16+16+2-1 DO
{ // i = 0 to 7   Blue A rays
  // i = 8 to 15  Red A rays
  // i = 16 to 23 Blue B rays
  // i = 24 to 31 Red B rays
  // i = 32 to 33 Blue and Red C rays
  LET x = px!i
  LET y = py!i

  IF x!1=1 & x!2=100 LOOP // An unset dot has x=100.

```

```

    add(y,nupb, avgy,nupb, tmp1,nupb)
    copy(tmp1,nupb, avgy,nupb)
    count := count+1
//writef("%i2 count=%i2 y= ",i, count); prnum(y, 5)
//writef("avgy=          ",i); prnum(avgy, 5)
}

//writef("count=%n*n", count)

IF count D0
{ divbyk(count, avgy,nupb) // Compute the average
//writef("average y=          "); prnum(avgy, 5)
  sub(cgy,3, avgy,nupb, tmp1,nupb)
  //writef("tmp1=          "); prnum(tmp1,5)
  // Take its absolute value
  tmp1!0 := FALSE
  //writef("centre dist= "); prnum(tmp1, 5)
  // If greater than dist, update dist.
  IF numcmp(tmp1,nupb, dist,nupb) > 0 D0 copy(tmp1,nupb, dist,nupb)
  //writef("dist=          "); prnum(dist, 5)
//abort(8888)
}

//writef("dist=          "); prnum(dist, 5)
//abort(8888)
setzero(spotsizesq,nupb)

// Calculate the radius squared
FOR i = 0 TO 16+16+2-1 DO
{ // i = 0 to 7   Blue A rays
  // i = 8 to 15  Red  A rays
  // i = 16 to 23 Blue B rays
  // i = 24 to 31 Red  B rays
  // i = 32 to 33 Blue and Red C rays
  LET x = px!i
  LET y = py!i

  IF x!1=1 & x!2=100 LOOP // An unset dot has x coordinate equal to 100.

  //writef("x=          "); prnum(x, 8)
  mul(x,nupb, x,nupb, tmp1,nupb) // tmp1 = x^2
  //writef("x^2=          "); prnum(tmp1, 8)

  //writef("avgy=          "); prnum(avgy, 8)

```

```

//writef("y=                "); prnum(y, 8)
sub(y,nupb, avgy,nupb, tmp2,nupb) // tmp2 = y-avgy
//writef("y-avgy=          "); prnum(tmp2, 8)
mul(tmp2,nupb, tmp2,nupb, tmp3,nupb) // tmp3 = (y-avgy)^2
//writef("(y-avgy)^2=      "); prnum(tmp3, 8)

add(tmp1,nupb, tmp3,nupb, tmp4,nupb) // tmp4 = x^2 + (y-avgy)^2
//writef("spot%n i=%i2 x^2 + (y-avgy)^2= ", spotno, i); prnum(tmp4, 8)

//sqrt(tmp4,nupb, tmp5,nupb)
//writef("tmp5=            "); prnum(tmp5, 8)

IF numcmp(tmp4,nupb, spotsizesq,nupb) > 0 DO copy(tmp4,nupb, spotsizesq,nupb)
//abort(1276)
}

// spotsizesq is the square of the largest distance.

sqrt(spotsizesq,nupb, tmp1,nupb)
//writef("spot%n size=      ", spotno); prnum(tmp1,8)

// tmp1 is the largest distance for the current spot.

// If it is larger than spotsize, update spotsize.
IF numcmp(tmp1,nupb, spotsize,nupb) > 0 DO copy(tmp1,nupb, spotsize,nupb)

//abort(1277)
}

```

The next function just creates the file `catageometry.txt` writing to it the current values of `factor`, `R1`, `R2`, `R3` and `R4`.

```

AND wrgeometry() BE
{ // Create file catageometry.txt with the current settings
  // of factor and R1 to R4.
  LET filename = "catageometry.txt"
  //writef("Calling findoutput(*"%s*")*n", filename)
  geometrystream := findoutput(filename)
  UNLESS geometrystream DO
  { writef(*nUnable to create file: *"%s*"*n", filename)
    abort(999)
    RETURN
  }
  selectoutput(geometrystream)
  writef("%n*n", factor)
}

```

```

prnum(R1,8)
prnum(R2,8)
prnum(R3,8)
prnum(R4,8)

writef(" *nGives spotsize: "); prnum(spotsize, 8)

endstream(geometrystream)
selectoutput(stdout)
}

AND readline(str) BE
{ LET len = 0

  { LET ch = rdch()
    IF ch = '*n' | ch=endstreamch | len>=255 BREAK
    len := len + 1
    str%len := ch
  } REPEAT

  str%0 := len
}

AND doray(n, ch, pos) BE // direction, radius ch, point number
{ LET dir = n=0 -> @dir0cx,
      n=1 -> @dir1cx,
      @dir2cx
  LET radius = ch='A' -> Arad, // Outer circle
              ch='B' -> Brad, // Inner circle
              0 // Centre point

  LET tmp1 = VEC nupb
  LET raddiv = VEC nupb
  LET focalx = ?
  AND focaly = ?

  LET px = n=0 -> spot0vx,
          n=1 -> spot1vx,
          spot2vx

  LET py = n=0 -> spot0vy,
          n=1 -> spot1vy,
          spot2vy

```



```

// Calculate the position of the dot coordinates
px, py := px+pos, py+pos // Add the position (0 to 7) in the circle
IF ch = 'A' DO px, py := px+ 0, py+ 0 // pos of dot pos circle A
IF ch = 'B' DO px, py := px+16, py+16 // pos of dot pos circle B
IF ch = 'C' DO px, py := px+32, py+32 // pos of then dot ray C
//abort(9999)
TEST radius=0
THEN setzero(raddiv,nupb)
ELSE div(radius,nupb, root2,nupb, raddiv,nupb)

IF tracing DO
{ writef("*ndoray: %c%n pos=%n*n", ch, n, pos)
  writef("root2= "); prnum(root2,8)
  writef("raddiv= "); prnum(raddiv,8)
}

setzero(Inz,nupb) // All entry points are in the plane z=0
SWITCHON pos INTO
{ DEFAULT: RETURN
  CASE 0: setzero(Inx,nupb)
    TEST radius=0
    THEN setzero(Iny,nupb)
    ELSE copy(radius,nupb, Iny,nupb)
    ENDCASE
  CASE 1: copy(raddiv,nupb, Inx,nupb)
    copy(raddiv,nupb, Iny,nupb)
    ENDCASE
  CASE 2: copy(radius,nupb, Inx,nupb)
    setzero(Iny,nupb)
    ENDCASE
  CASE 3: copy(raddiv,nupb, Inx,nupb)
    copy(raddiv,nupb, Iny,nupb); Iny!0 := TRUE
    ENDCASE
  CASE 4: setzero(Inx,nupb)
    copy(radius,nupb, Iny,nupb); Iny!0 := TRUE
    ENDCASE
  CASE 5: copy(raddiv,nupb, Inx,nupb); Inx!0 := TRUE
    copy(raddiv,nupb, Iny,nupb); Iny!0 := TRUE
    ENDCASE
  CASE 6: copy(radius,nupb, Inx,nupb); Inx!0 := TRUE
    setzero(Iny,nupb)
    ENDCASE
  CASE 7: copy(raddiv,nupb, Inx,nupb); Inx!0 := TRUE
    copy(raddiv,nupb, Iny,nupb)
    ENDCASE
}

```

```

}

//writef("nIncident ray intersection with the plane z=0n")
//writef("Inx= "); prnum(Inx,8)
//writef("Iny= "); prnum(Iny,8)
//writef("Inz= "); prnum(Inz,8)

//writef("nDirection of the incident rayn")
//writef("dir!0= "); prnum(dir!0,8)
//writef("dir!1= "); prnum(dir!1,8)
//writef("dir!2= "); prnum(dir!2,8)

//writef("nEntry point %cn, Direction %n, Blue*n", ch, pos, n)
focalx, focaly := px!0, py!0 // Location of a blue dot
raytrace(dir, @Inx, Blue, focalx, focaly)

IF tracing DO
{ newline()
  writef("%cn Blue x= ",ch,pos); prnum(focalx,8)
  writef("%cn Blue y= ",ch,pos); prnum(focaly,8)
}

setcolour(c_blue)
//IF pos<4 DO
  drawdot(n, scale(focalx), scale(focaly))

//IF tracing DO
// abort(5000)

//writef("nEntry point %cn, Direction %n, Red*n", ch, pos, n)

TEST ch='C'
THEN focalx, focaly := px!1, py!1 // Location of a red dot for C
ELSE focalx, focaly := px!8, py!8 // Location of a red dot for A or B
raytrace(dir, @Inx, Red, focalx, focaly)

IF tracing DO
{ newline()
  writef("%cn Red x= ",ch,pos); prnum(focalx,8)
  writef("%cn Red y= ",ch,pos); prnum(focaly,8)
}

setcolour(c_red)
//IF pos<4 DO
  drawdot(n, scale(focalx), scale(focaly))

```

```

//IF tracing DO
// abort(5001)
}

AND scale(num) = VALOF
{ LET res = ?
  LET e = num!1
  IF e>1 DO res := 9999_9999
  IF e=1 DO res := num!2 * 10000 + num!3
  IF e=0 DO res := num!2
  IF e<0 DO res := 0
  IF num!0 DO res := -res
  // res is in unit of 1/10000 mm
  //writef("scale: num= "); prnum(num, 5)
  //writef("scale: res=%n*n", res)
  RESULTIS res
}

```

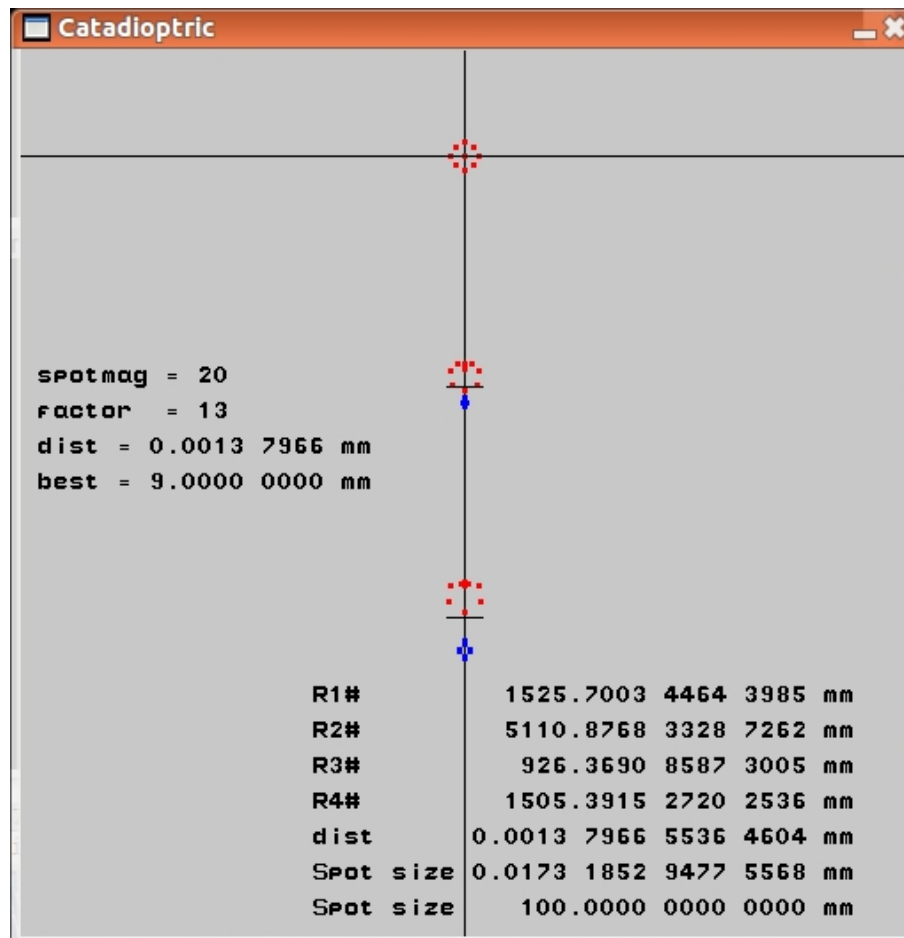

This screenshot shows the scattering of blue and red dots corresponding to rays passing through centre and eight equally placed positions on the objective lens 50mm from the z axis from point sources of light on the axis and 1/8 and 1/4 degree off the axis. To make the patterns for each light source more visible they have been magnified by a factor of 20. Without this magnification they would have a size of about 2 pixels. The size of the central image is only about 50% larger than the Airy disc for this telescope. The other two images are about 2 and 3 times the Airy disc size. So the resolution of this telescope is quite good.

5.20 A 3D Demo using SDL

The example in this section illustrates how to display a three dimensional object with hidden surface removal. When compiled and run the program will create a window containing an image of a simple model of an aircraft similar to the following.

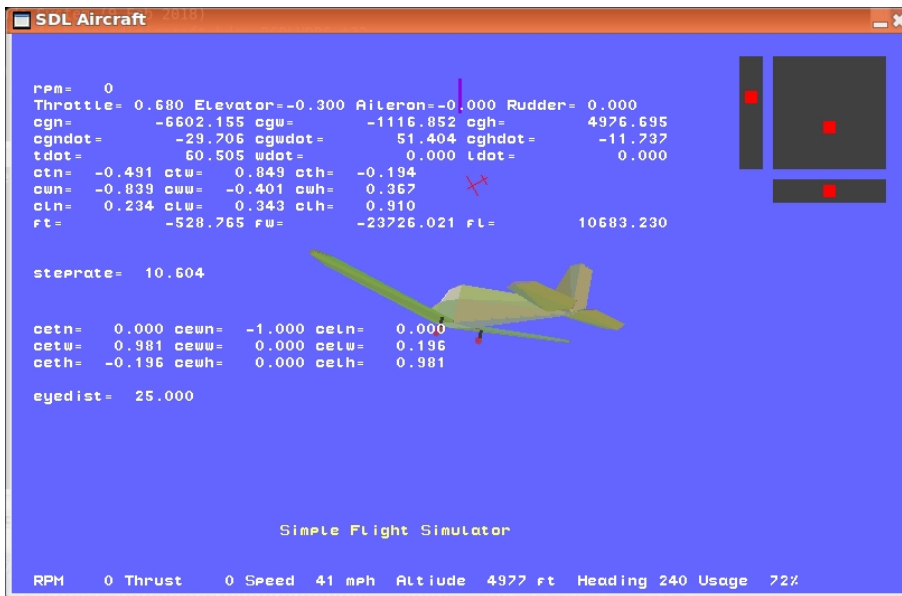

The whole of this section needs to be re-written.

It will rotate with increasing speed but may be paused by pressing P and the orientation and speed of rotation may be reset by pressing R. The eye position may be moved further from the object by pressing F making it look smaller, and N moves the eye position closer. You can exit from the program by pressing Q.

An important aspect of the problem is how to represent the orientation of the object being displayed. For simplicity, let us assume the object to display is an aircraft with three embedded axes, \mathbf{t} in the direction of thrust, \mathbf{w} in the direction of the left (port) wing and \mathbf{l} in the direction of lift, assumed to be orthogonal to both \mathbf{t} and \mathbf{w} . We will call the \mathbf{t} , \mathbf{w} and \mathbf{l} the body axes, not to be confused with the real world axes \mathbf{x} , \mathbf{y} and \mathbf{z} . For our purposes we will assume the world

is not a sphere like the earth but flat with \mathbf{x} pointing north, \mathbf{y} pointing west and \mathbf{z} pointing up. The orientation of the aircraft can be specified in various ways. A common way is to use *Euler angles* which give the amount of rotation needed to move the aircraft from a state pointing north with wings level to the required orientation. The rotations are done in a defined order such as (1) rotate about axis \mathbf{w} , then (2) rotate about axis \mathbf{l} and finally (3) rotate about axis \mathbf{t} . By this means any orientation can be reached. But notice that the order in which the rotations are done is significant.

Another method, particularly favoured by implementers of flight simulators, is to use *quarternions*. These were discovered by an Irish mathematician William Rowan Hamilton in 1843. We are used to the idea of representing complex numbers in two dimensions with the \mathbf{i} axis orthogonal to the real axis, and we have seen multiplication of complex numbers can represent rotations and possible scaling in two dimensions. Quarternions are like complex numbers but in a higher number of dimensions. While complex numbers are typically written as $a + ib$, quarternions are written as $a + ib + jc + kd$. With complex numbers the \mathbf{i} axis is orthogonal to the real axis, but with quarternions the mind blowing idea is that \mathbf{i} is still orthogonal to the real axis but so are \mathbf{j} and \mathbf{k} and furthermore \mathbf{i} , \mathbf{j} and \mathbf{k} are orthogonal to each other, so must live in a four dimensional space which is hard to visualise. As with complex numbers, multiplying by i corresponds to a rotation of 90 degrees, and $i^2 = -1$. With quarternions, multiplying by i , j and k correspond to different rotations of 90 degrees and $i^2 = j^2 = k^2 = -1$. Furthermore, Hamilton's major breakthrough was the realisation that ijk also equals -1. He was so excited by this discovery that he could not resist the urge to carve $i^2 = j^2 = k^2 = ijk = -1$ into the stone of Brougham Bridge in Dublin. Unfortunately his carving is no longer visible. From these equations it is easy to deduce that $ij = k$, $ji = -k$, $jk = i$, $kj = -i$, $ki = j$ and $ik = -j$. Notice that $ij \neq ji$, so the algebra is not commutative which is, of course, also true of rotations in three dimensions. If we multiply two quarterions $a_1 + b_1i + c_1j + d_1k$ by $a_2 + b_2i + c_2j + d_2k$ using the normal rules of algebra and simplify the result using the above equations, we obtain

$$\begin{aligned} &(a_1a_2 - b_1b_2 - c_1c_2 + d_1d_2)+ \\ &(a_1b_2 + b_1a_2 + c_1d_2 - d_1c_2)i+ \\ &(a_1c_2 - b_1d_2 + c_1a_2 + d_1b_2)j+ \\ &(a_1d_2 + b_1c_2 - c_1b_2 + d_1a_2)k \end{aligned}$$

Just as any non zero complex number has an inverse that corresponds to undoing a rotation on 2D, any non zero quarternion also has an inverse corresponding to undoing a 3D rotation. Indeed, there are two inverses depending on whether pre- or post- multiplication is used.

Having just given a very brief introduction to quaternions with hints as to why they are useful for describing 3D rotations, I am going to drop the idea and use yet another mechanism for describing the orientation of the aircraft.

In the programs that follow, I use *direction cosines*. If we want to specify the direction of thrust \mathbf{t} we can use the coordinates of a point T on the unit sphere centred at the origin O with OT parallel to the directions of thrust. In the programs that follows these coordinates are held in the variables `ctx`, `cty` and `ctz`. They are called direction cosines because, for instance, `ctx` is the cosine of the angle between the x axis and the direction of thrust. The variables `ctx`, `cty` and `ctz` hold the cosines for direction \mathbf{w} and `clx`, `cly` and `clz` hold the cosines for \mathbf{l} .

They are held as 32-bit floating point numbers which provides adequate precision for our purposes. Using direction cosines may seem inefficient since they require 9 variables rather than the three for Euler angles or four for quaternions, but they are easier to understand and use, particularly for the calculations needed to plot instruments such as the artificial horizon or points on the ground as viewed by the pilot. The cost of performing rotations is insignificant compared to other computations performed by the flight simulator.

The program that drew the picture given above is called `sdlaircraft.b` and it starts as follows.

```

/*
This is a simple demonstration of drawing in 3D using
the SDL graphics library.

Implemented by Martin Richards (c) January 2012

History

31/05/2018
Significant reimplementatation of the program.

12/03/2018
Extensively modified to use floating point and the new FLT feature.

Controls

Either use a USB Joystick for elevator, ailerons and throttle, or
use the keyboard as follows:

Up arrow      Trim joystick forward a bit
Down arrow    Trim joystick backward a bit
Left arrow    Trim joystick left a bit

```

```

Right arrow  Trim joystick right a bit

, or <      Trim rudder left
. or >      Trim rudder right

p           pause/unpause the simulation
u           Toggle plot usage
d           Toggle debugging
g           Toggle gear down
s           Toggle start engine
x           More throttle
z           Less throttle

0           Display the pilot's view
1,2,3,4,5,6,7,8 Display the aircraft viewed from various angles

f           View aircraft from a greater distance
n           View aircraft from a closer position
g           Reset the aircraft on the glide path
t           Reset the aircraft ready for take off -- default
            ie stationary on the ground at the end of the runway

q           Quit

```

There are joystick buttons equivalent to Up arrow, Down arrow, Left Arrow and Right arrow. There are also joystick buttons to trim the rudder left and right, useful for steering on the runway.

The display shows various beacons on the ground including the lights on the sides and the ends of the runway.

The display also shows various flight instruments including the artificial horizon, the height and speed and various navigational aids to help the pilot find the runway.

*/

```

GET "libhdr"
GET "sdl.h"
GET "sdl.b"          // Insert the SDL BCPL library
.
GET "libhdr"
GET "sdl.h"

MANIFEST {

```

```

FLT D45 = 0.70710678 // cosine of pi/4 = sqrt(2)

// Most measurements are in feet, held as floating point numbers.

FLT k_g = 32.0 // Acceleration due to gravity, 32 ft per sec per sec

FLT mass = 2000.0 // Mass of the aircraft. This should perhaps be a
// variable since it depends on the weight of the
// pilot and how much fuel is in the tank.

// Conversion factors
FLT fps2mph = 60*60/5280.0
FLT mph2fps = 1.0/fps2mph

FLT Left = +1.0 // Used when drawing wings etc.
FLT Right = -1.0
}

GLOBAL {
  done:ug

  FLT One // Set to 1.0 Loading globals are cheaper than
  FLT Zro // Set to 0.0 loading 32-bit constants.

  stepping // =FALSE if not stepping the simulation
  stepcount
  msecsl // Used in the calculation of steprate
  FLT steprate

  crashed // =TRUE if crashed
  debugging // Toggled by the D command.
  geardown
  enginestarted // Toggled by S.

  col_black
  col_blue
  col_green
  col_yellow
  col_red
  col_majenta
  col_cyan
  col_white
  col_darkgray
  col_darkblue
  col_darkgreen

```



```

col_darkyellow
col_darkred
col_darkmagenta
col_darkcyan
col_gray
col_lightgray
col_lightblue
col_lightgreen
col_lightyellow
col_lightrred
col_lightmagenta
col_lightcyan

FLT c_throttle; FLT c_trimthrottle; FLT throttle // 0.0 to +1.0 zero to full power
FLT c_aileron; FLT c_trimaileron; FLT aileron // -1.0 to +1.0 stick left to right
FLT c_elevator; FLT c_trimelevator; FLT elevator // -1.0 to +1.0 stick back to forward
FLT c_rudder; FLT c_trimrudder; FLT rudder // -1.0 to +1.0 full left to right

FLT rpm; FLT targetrpm
FLT thrust

FLT coselevator; FLT sinelevator
FLT cosaileron; FLT sinaileron
FLT cosrudder; FLT sinrudder

FLT cockpitl // For the pilot's view

// Below t is the direction of the aircraft
FLT ctn; FLT ctw; FLT cth // Direction cosines of direction t (forward)
FLT cwn; FLT cww; FLT cwh // Direction cosines of direction w (left)
FLT cln; FLT clw; FLT clh // Direction cosines of direction l (lift)

// Below t is the direction of the eye
FLT cetn; FLT cetw; FLT ceth // Eye direction cosines of direction t (forward)
FLT cewn; FLT ceww; FLT cewh // Eye direction cosines of direction w (left)
FLT celn; FLT celw; FLT celh // Eye direction cosines of direction l (lift)

FLT eyedist // Eye distance from aircraft
FLT eyeheight // Eye height relative to cgh

// The following is the matrix used by screencoords when
// transforming either aircraft or ground points to
// screen coordinates.
FLT m00; FLT m01; FLT m02 // First row
FLT m10; FLT m11; FLT m12 // Second row

```

```

FLT m20; FLT m21; FLT m22          // Third row

setaircraftmat    // Use to set the above matrix.
setgroundmat

// The following take vertices of the aircraft model.
cdrawquad3d       // (x1,y1,z1, x2,y2,z2, x3,y3,z3, x4,y4,z4)
cdrawtriangle3d   // (x1,y1,z1, x2,y2,z2, x3,y3,z3)
                  // These use twl coordinates relative to the
                  // aircraft's origin.

// The following take vertices of points on the ground.
gdrawquad3d       // (x1,y1,z1, x2,y2,z2, x3,y3,z3, x4,y4,z4)
gdrawtriangle3d   // (x1,y1,z1, x2,y2,z2, x3,y3,z3)
                  // These use nwh world coordinates to draw
                  // the runway and other points on the ground.

                  // All these coordinates are floating point values.

FLT cgn; FLT cgw; FLT cgh          // Aircraft position in world coordinates
FLT cgndot; FLT cgwdot; FLT cghdot // Aircraft velocity in world coordinates

// Speed in various directions is measured in ft/s.
FLT tdot; FLT wdot; FLT ldot // Speed in the aircraft t, w and l directions
FLT ft; FLT fw; FLT fl // Linear forces on the aircraft
FLT rft; FLT rfw; FLT rfl // Rotational forces on the aircraft

FLT usage          // 0 to 100 percentage cpu usage

hatdir            // Hat direction given by the joystick.
hatmsecs         // msec of last hat change.
eyedir           // An integer specifying the eye direction
                  // 0 = cockpit view
                  // 1,...,8 looking N,NE,E,SE,S,SW,W and NW.
}

LET rotate(FLT rt, FLT rw, FLT rl) BE
{ // Rotate the aircraft about axes t, w and l.
  // rt, rw and rl are assumed to be small rotational angles
  // causing rotation about axes t, w, l. Positive values cause
  // anti-clockwise rotations about their axes.

  LET FLT tx =      ctn - rl * cwn + rw * cln
  LET FLT wx =     rl * ctn +      cwn - rt * cln
  LET FLT lx = -rw * ctn + rt * cwn +      cln

```

```

LET FLT ty =      ctw - rl * cww + rw * clw
LET FLT wy =  rl * ctw +      cww - rt * clw
LET FLT ly = -rw * ctw + rt * cww +      clw

LET FLT tz =      cth - rl * cwh + rw * clh
LET FLT wz =  rl * cth +      cwh - rt * clh
LET FLT lz = -rw * cth + rt * cwh +      clh

ctn, ctw, cth := tx, ty, tz
cwn, cww, cwh := wx, wy, wz
cln, clw, clh := lx, ly, lz

adjustorientation()
}

AND adjustorientation() BE
{ // Make minor corrections to ensure that the axes are orthogonal and
  // of unit length.
  adjustlength(@ctn);      adjustlength(@cwn);      adjustlength(@cln)
  adjustortho(@ctn, @cwn); adjustortho(@ctn, @cln); adjustortho(@cwn, @cln)
}

AND radius2(FLT x, FLT y) = sys(Sys_flt, fl_sqrt, x*x + y*y)

AND radius3(FLT x, FLT y, FLT z) = sys(Sys_flt, fl_sqrt, x*x + y*y + z*z)

AND adjustlength(v) BE
{ // This helps to keep vector v of unit length
  LET FLT x, FLT y, FLT z = v!0, v!1, v!2
  LET FLT r = radius3(x,y,z)
  v!0 := x / r
  v!1 := y / r
  v!2 := z / r
}

AND adjustortho(a, b) BE
{ // This helps to keep the unit vector b orthogonal to a
  LET FLT a0, FLT a1, FLT a2 = a!0, a!1, a!2
  LET FLT b0, FLT b1, FLT b2 = b!0, b!1, b!2
  LET FLT corr = a0*b0 + a1*b1 + a2*b2 // cos of angle between a and b.
  b!0 := b0 - a0 * corr
  b!1 := b1 - a1 * corr
  b!2 := b2 - a2 * corr
}

```

```

AND angle(FLT x, FLT y) = x=0 & y=0 -> 0.0, VALOF
{ // Calculate the angle in degrees between
  // point (x,y) and the x axis using atan2.
  // If (x,y) is above the x-axis the result is between 0 and +180
  // If (x,y) is below the x-axis the result is between 0 and -180
  LET FLT a = sys(Sys_flt, fl_atan2, y, x) * 180.0 / 3.14159
//plotf(20, 30, "angle: x=%13.3f y=%13.3f => angle = %8.3f*n",
//      x, y, a)
  RESULTIS a
}

LET step() BE
{ LET FLT speed = 0.0

  // The linear forces on the CG of the aircraft in directions
  // t, w and l initialised as follows.
  ft, fw, fl := Zro, Zro, Zro
  rft, rfw, rfl := Zro, Zro, Zro

  // These are in poundals.
  // 1 poundal will accelerate a mass of 1 lb at a rate
  // of 1 ft/s/s. A force of mass x g will just hold the aircraft
  // up against gravity.

  // First calculate the engine RPM.
  targetrpm := 0.0 // If engine is not started
  IF enginestarted DO
  { // The throttle is in the range 0.0 to 1.0
    targetrpm := 600.0 + 1700.0 * throttle +
                 0.7 * tdot // + air speed effect
  }

  // The rpm take time to change.
  rpm := rpm + (targetrpm - rpm) / (4.0*steprate) - 1.0
  //rpm := targetrpm // For debugging always set rpm to targetrpm
  IF rpm < 0.0 DO rpm := 0.0

  // Now calculate the thrust.
  thrust := VALOF
  { // At rpm=2200 the aircraft should reach a take off speed of 65mph after
    // travelling about 1700 ft along the runway.
    // Assume the angle of attack of the propeller is such that
    // when rpm=2500 the speed at which the thrust is zero is about 200mph
    // or 200*5280 / (60*60) = about 293.0 ft/s.

```

```

// At a speed of tdot ft/s, the rpm giving zero thrust is
// (2500/293) * tdot. Ie linear between 0 and 293.
// At a speed of 65mph = 95ft/s the rpm of zero thrust is thus
// (2500/293)*95 = 810 (rpm0)
// Assume that the thrust at this speed is Kt * (rpm-rpm0)^2
// and that the drag is Kd * tdot^2 = Kd * 95^2 = 9025*Kd
// Assume that at this speed with rpm=2000 the thrust-drag
// is sufficient to give the aircraft an acceleration of g/8.
// Thus mass*g/8 = Kt * (2000-810)^2 - 9025 * Kd
// Assume mass=2000 and g=32, this gives
// 2000*32/8 = Kt * (2000-810)^2 - 9025 * Kd
// or 8000 = Kt * 134300 = 9025 * Kd
LET FLT vmax = 293.0 * rpm / 2500 // Speed in ft/s at which thrust=0
LET FLT vmaxby2 = vmax/2 // use linear interpolation between
// vmax and vmaxby2
LET FLT tmax = 1.7 * mass * k_g // Thrust to give acceleration of
// 1.7 * g ignoring drag.

LET FLT t = ?
// IF rpm is too small or tdot is too great there is no thrust.
IF rpm<600 | tdot>vmax RESULTIS 0.0
// When rpm>=600 the thrust is proportional to the square of (rpm-600)
// When rpm=2200 the thrust is sufficient to accelerate the aircraft at g/8
t := tmax * (rpm-600)*(rpm-600) / ((2200-600) * (2200-600))
IF tdot<vmaxby2 RESULTIS t
RESULTIS t * (vmax-tdot) / vmaxby2
}

// Gravity effect
ft := ft - mass * k_g * cth // Gravity in direction t
fw := fw - mass * k_g * cwh // Gravity in direction w
fl := fl - mass * k_g * clh // Gravity in direction l

// Lift effect
{ LET FLT lift = 0.0

// Lift is proportional to speed above 30 ft/s and
// at 95 ft/s is just sufficient to hold the aircraft
// up against gravity.

IF tdot>30.0 DO lift := mass * k_g * (tdot-30.0) / (95.0-30.0)

// Lift and elevator effect
fl := fl + lift - mass * k_g * 1.00 * elevator * tdot/95.0
}

```

```

// Drag effect proportional to tdot squared.
// throttle at 0.5 gives rpm=1466 and level speed of 62 mph
// throttle at 1.0 gives rpm=2371 and level speed of 116 mph
ft := ft -
    mass * k_g * 0.50 * tdot * tdot / (95.0 * 95.0)

// Thrust effect
ft := ft + thrust

// Rudder effect
fw := fw -
    mass * k_g * 0.5 * rudder // Apply force in direction w to
                             // cause turning about axis l.

IF cgh < 20.0 DO
{ wheeleffect( 4.0, 0.0, -2.0) // Front wheel effect
  wheeleffect(-0.7, 3.0, -2.0) // Left wheel effect
  wheeleffect(-0.7, -3.0, -2.0) // Right wheel effect
}

// Aileron effect -- actually rotate the aircraft about axis t,
// also deal with dihedral effect.
rft := rft - 1.2 * aileron / steprate - 0.00001 * fw / steprate

rotate(rft, rfw, rfl)

tdot := tdot + 1.00 * ft / (mass * steprate)
wdot := wdot + 1.00 * fw / (mass * steprate)
ldot := ldot + 1.00 * fl / (mass * steprate)

// Calculate the real world velocity
cgndot := tdot*ctn + wdot*cwn + ldot*cln
cgwdot := tdot*ctw + wdot*cww + ldot*clw
cghdot := tdot*cth + wdot*cwh + ldot*clh

// Calculate new n, w and h positions.
cgn := cgn + cgndot / steprate
cgw := cgw + cgwdot / steprate
cgh := cgh + cghdot / steprate

IF radius3(cgndot, cgwdot, cghdot) > 9.0 DO
{ // Make the aircraft point in the direction of the velocity
  // vector unless the speed is less than 5 ft/s.

```

```

// OV is the velocity vector
// x, y and z are it coordinates in directions t, w and l.
// r3 is the length of OV
// r2 is the length of OP where P lies in the plane tw
//                               and VP is orthogonal to this plane.
// phi is the angle between OP and the t axis.
// theta is the angle between OP and the plane tw.
// To avoid overflow these angles have special values
// if r2 and/or r3 are too small.

LET FLT x = cgndot*ctn + cgwdot*ctw + cghdot*cth // = v.t
LET FLT y = cgndot*cwn + cgwdot*cww + cghdot*cwh // = v.w
LET FLT z = cgndot*cln + cgwdot*clw + cghdot*clh // = v.l
LET FLT r2 = radius2(x,y)
LET FLT r3 = radius3(x,y,z)
// If the speed is not sufficient the rotation angles are given
// special values.
LET FLT cphi = r3<1.0 | r2<0.001 -> 1.0, // No rotation about l
              x / r2 // phi is the rotation angle about l
LET FLT sph = r3<1.0 | r2<0.001 -> 0.0, // No rotation about l
              y / r2 // phi is the rotation angle about l

LET FLT ctheta = r3<1.0 -> 1.0, // No rotation about theta
              r2 / r3 // theta is the rotation angle about w
LET FLT stheta = r3<1.0 -> 0.0, // No rotation about theta
              z / r3 // theta is the rotation angle about w

// Matrix to rotate aircraft clockwise about axis l
// ( cphi  sph  0 )
// (-sph  cphi  0 )
// ( 0    0    1 )

// Matrix to rotate aircraft clockwise about axis w
// ( ctheta  0  stheta )
// ( 0    1    0 )
// (-stheta 0  ctheta )

// Combining these gives
// ( ctheta*cphi  ctheta*sph  stheta )
// ( -sph        cphi        0 )
// (-stheta*cphi -stheta*sph  ctheta )

// Apply this matrix to the old orientation

```

```

LET FLT nctn = ctheta*cphi*ctn + ctheta*sphi*cwn + stheta*cln
LET FLT nctw = ctheta*cphi*ctw + ctheta*sphi*cww + stheta*clw
LET FLT ncth = ctheta*cphi*cth + ctheta*sphi*cwh + stheta*clh

LET FLT ncwn = -sphi*ctn + cphi*cwn
LET FLT ncww = -sphi*ctw + cphi*cww
LET FLT ncwh = -sphi*cth + cphi*cwh

LET FLT ncln = -stheta*cphi*ctn - stheta*sphi*cwn + ctheta*cln
LET FLT nclw = -stheta*cphi*ctw - stheta*sphi*cww + ctheta*clw
LET FLT nclh = -stheta*cphi*cth - stheta*sphi*cwh + ctheta*clh

IF FALSE DO
{
newline()
writef("cgndot=%13.3f cgwdot=%13.3f cghdot=%13.3f*n", cgndot, cgwdot, cghdot)
newline()
writef("x= %13.3f y= %13.3f z= %13.3f*n", x, y, z)
writef("r2=%13.3f r3=%13.3f*n", r2, r3)
newline()
writef("cphi =%8.3f sphi= %8.3f*n", cphi, sphi)
writef("ctheta=%8.3f stheta=%8.3f*n", ctheta, stheta)
newline()
writef("ctn=%8.3f ctw=%8.3f cth=%8.3f*n", ctn, ctw, cth)
writef("cwn=%8.3f cww=%8.3f cwh=%8.3f*n", cwn, cww, cwh)
writef("cln=%8.3f clh=%8.3f clh=%8.3f*n", cln, clw, clh)
writef("rotation matrix about l*n")
writef("( %8.3f %8.3f %8.3f*n", cphi, sphi, 0.0)
writef("( %8.3f %8.3f %8.3f*n", -sphi, cphi, 0.0)
writef("( %8.3f %8.3f %8.3f*n", 0.0, 0.0, 1.0)
newline()
writef("rotation matrix about w*n")
writef("( %8.3f %8.3f %8.3f*n", ctheta, 0.0, stheta)
writef("( %8.3f %8.3f %8.3f*n", 0.0, 1.0, 0.0)
writef("( %8.3f %8.3f %8.3f*n", -stheta, 0.0, ctheta)
newline()
writef("combined rotation matrix*n")
writef("( %8.3f %8.3f %8.3f*n", ctheta*cphi, ctheta*sphi, stheta)
writef("( %8.3f %8.3f %8.3f*n", -sphi, cphi, 0.0)
writef("( %8.3f %8.3f %8.3f*n", -stheta*cphi, -stheta*sphi, ctheta)
newline()
writef("nctn=%8.3f nctw=%8.3f ncth=%8.3f*n", nctn, nctw, ncth)
writef("ncwn=%8.3f ncww=%8.3f ncwh=%8.3f*n", ncwn, ncww, ncwh)
writef("ncln=%8.3f nclw=%8.3f nclh=%8.3f*n", ncln, nclw, nclh)

```



```

newline()
}
    // Update the orientation with these values
    ctn, ctw, cth := nctn, nctw, ncth
    cwn, cww, cwh := ncwn, ncww, ncwh
    cln, clw, clh := ncln, nclw, nclh

    adjustorientation()

    // The aircraft is now pointing in the direction of its
    // velocity vector.
    wdot, ldot := 0.0, 0.0

    //cgndot, cgwdot, cghdot := tdot, 0.0, 0.0
//abort(6789)

}
}

AND wheeleffect(FLT t, FLT w, FLT l) BE
{ // (t,w,l) are the coordinates in aircraft of the
  // lowest point of a wheel.
  LET FLT h = t*cln + w*clw + l*clh + cgh // Height above the ground

writef("wheeleffect: clt=%6.3f clw=%6.3f clh=%6.3f cgh=%6.3f*n", cln, clw, clh, cgh)
writef("wheeleffect: t=%6.3f w=%6.3f l=%6.3f h=%6.3f*n", t, w, l, h)
  IF h < 0.0 DO
  { // The lift from the wheel is proportional to the depth -h
    // reduced if cghdot is positive.
    LET FLT f = -h * mass * k_g/100.0 // Depth of 1 ft gives an upward
                                     // force equal to the weight of
                                     // the aircraft

    IF cghdot > 0.0 DO f := f/2.0 // Reduce if moving upward
    //fl := fl + f
    //IF cghdot < 0.0 DO cghdot := 0

    // Apply rotational effect
    // The is an anticlockwise rotational force about w proportional
    // to t * f
    rfw := rfw + 0.0001*t*f
    // The is an clockwise rotational force about t proportional
    // to t * f
    rft := rft - 0.0001*w*f
    //rotate(rft, rfw, 0.0)
  }
}

```

```

newline()
writef("t=%6.2f w=%6.2f l=%6.2f depth=%9.3f cghdot=%9.3f cgh=%9.3f force=%9.3f*n",
      t,w,l, -h, cghdot, cgh, f)
writef("stepcount=%i5 rft=%9.6f rfw=%9.6f*n", stepcount, rft, rfw)
//abort(9765)

    IF clh<0.75 | cghdot < -10.0 DO
    { // The aircraft is not level enough or it is coming down
      // too fast.
writef("Crashed because clh=%9.3f cghdot=%9.3f*n", clh, cghdot)
      crashed := TRUE
      RETURN
    }
  }
}

AND cleardepthscreen() BE
{ LET FLT val = -1e10
  IF depthscreen FOR i = 0 TO screenxsize*screenysize-1 DO
    depthscreen!i := val
}

AND plotland() BE
{ setgroundmat()

/*
// Debugging code
setcolour(maprgb(255, 0, 0))
gdrawquad3d( 20.0, 5.0, -5.0, // Base of object
            20.0, -5.0, -5.0,
            50.0, -5.0, -5.0,
            50.0, 5.0, -5.0)

setcolour(maprgb(0, 0, 255))
gdrawtriangle3d( 50.0, 5.0, -5.0, // Blue triangular end
               50.0, 0.0, 5.0,
               50.0, -5.0, -5.0)

// RETURN
*/

// Draw the runway 2000 x 100 ft
FOR i = 0 TO 19 FOR j = 0 TO 4 DO
{ LET FLT n = 100.0 * FLOAT i
  LET FLT w = -50.0 + 20.0 * FLOAT j
  LET c = ((127*n XOR 541*j) MOD 13) * 4
  setcolour(maprgb(170+c, 170+c, 170+c))
}
}

```

```

    gdrawquad3d(      n,      w, 0.0, // The runway
                  n, 20.0+w, 0.0,
                  100.0+n, 20.0+w, 0.0,
                  100.0+n,      w, 0.0)
}
}

AND plotcraft() BE
{ coselevator := sys(Sys_flt, fl_cos, elevator*0.7)
  sinelevator := sys(Sys_flt, fl_sin, elevator*0.7)
  cosaileron  := sys(Sys_flt, fl_cos, aileron*0.7)
  sinaileron  := sys(Sys_flt, fl_sin, aileron*0.7)
  cosrudder   := sys(Sys_flt, fl_cos, rudder*0.7)
  sinrudder   := sys(Sys_flt, fl_sin, rudder*0.7)

//writef("plotcraft:  elevator =%8.3f      aileron= %8.3f      rudder= %8.3f*n",
//      elevator, aileron, rudder)
//writef("plotcraft: coselevator=%8.3f      sinelevator=%8.3f*n", coselevator, sinelevator)
//writef("plotcraft: cosaileron =%8.3f      sinaileron= %8.3f*n", cosaileron, sinaileron)
//writef("plotcraft: cosrudder  =%8.3f      sinrudder= %8.3f*n",  cosrudder, sinrudder)

setaircraftmat()

IF FALSE DO
{ // Debugging simple aircraft
  setcolour(maprgb(255,0,0)) //Red
  cdrawtriangle3d( 2.0,  0.0, 0.0, // left wing
                 0.0, 10.0, 0.0,
                 -2.0,  0.0, 0.0)

  setcolour(maprgb(0,255,0)) //Green
  cdrawtriangle3d( 2.0,  0.0, 0.0, // Right wing
                 0.0,-10.0, 0.0,
                 -2.0,  0.0, 0.0)

  setcolour(maprgb(0,0,255)) //Blue
  cdrawtriangle3d( 10.0,  0.0,  0.0, // Body
                 0.0,  0.0, -2.0,
                 -10.0,  0.0,  0.0)

  setcolour(maprgb(255,255,0)) //Yellow
  cdrawtriangle3d( -8.0,  0.0,  0.0, // Fin
                 -10.0,  0.0,  2.0,
                 -10.0,  0.0,  0.0)
}

```

```

    RETURN
  }

  drawcraftside(Left)
  drawcraftside(Right)
//updatescreen()
//abort(2345)
}

AND drawcraftside(side) BE
{ drawbody(side)
  drawing(side)
  drawelevator(side)
  drawfin(side)
}

AND drawwheel(t, w, l) BE IF geardown DO
{ LET FLT T1t, FLT T1w, FLT T1l = t, w, l
  LET FLT T2t, FLT T2w, FLT T2l = t-0.2, w-0.1, l
  LET FLT T3t, FLT T3w, FLT T3l = t-0.2, w+0.1, l

  LET FLT B1t, FLT B1w, FLT B1l = T1t, T1w, T1l-1.0
  LET FLT B2t, FLT B2w, FLT B2l = T2t, T2w, T3l-1.0
  LET FLT B3t, FLT B3w, FLT B3l = T3t, T3w, T3l-1.0

  LET FLT WRt, FLT WRw, FLT WRl = t-0.1, B1w-0.13, B1l
  LET FLT WLt, FLT WLw, FLT WLl = t-0.1, B1w+0.13, B1l

  // Draw strut
  setcolour(maprgb(84,84,84))
  cdrawquad3d(T1t, T1w, T1l,
              T2t, T2w, T2l,
              B2t, B2w, B2l,
              B1t, B1w, B2l)
  cdrawquad3d(T1t, T1w, T1l,
              T3t, T3w, T3l,
              B3t, B3w, B3l,
              B1t, B1w, B1l)
  setcolour(maprgb(54,54,54))
  cdrawquad3d(T3t, T3w, T3l,
              T2t, T2w, T2l,
              B2t, B2w, B2l,
              B3t, B3w, B3l)

  // Draw tyre

```

```

setcolour(maprgb(180,50,104))
cdrawtriangle3d(WRt,      WRw, WRl,      // Top quadrant
                WRt+0.000, WRw, WRl+0.282,
                WRt-0.200, WRw, WRl+0.200)
setcolour(maprgb(150,81,75))
cdrawquad3d(WRt+0.000, WRw, WRl+0.282,
            WRt-0.200, WRw, WRl+0.200,
            WLt-0.200, WLw, WLl+0.200,
            WLt+0.000, WLw, WLl+0.282)
setcolour(maprgb(180,50,104))
cdrawtriangle3d(WLt,      WLw, WLl,
                WLt+0.000, WLw, WLl+0.282,
                WLt-0.200, WLw, WLl+0.200)

setcolour(maprgb(180,50,104))
cdrawtriangle3d(WRt,      WRw, WRl,
                WRt+0.000, WRw, WRl+0.282,
                WRt+0.200, WRw, WRl+0.200)
setcolour(maprgb(150,81,75))
cdrawquad3d(WRt+0.000, WRw, WRl+0.282,
            WRt+0.200, WRw, WRl+0.200,
            WLt+0.200, WLw, WLl+0.200,
            WLt+0.000, WLw, WLl+0.282)
setcolour(maprgb(180,50,104))
cdrawtriangle3d(WLt,      WLw, WLl,
                WLt+0.000, WLw, WLl+0.282,
                WLt+0.200, WLw, WLl+0.200)

setcolour(maprgb(180,50,104))
cdrawtriangle3d(WRt,      WRw, WRl,      // Back quadrant
                WRt-0.282, WRw, WRl+0.000,
                WRt-0.200, WRw, WRl+0.200)
setcolour(maprgb(150,81,75))
cdrawquad3d(WRt-0.200, WRw, WRl+0.200,
            WRt-0.282, WRw, WRl+0.000,
            WLt-0.282, WLw, WLl+0.000,
            WLt-0.200, WLw, WLl+0.200)
setcolour(maprgb(180,50,104))
cdrawtriangle3d(WLt,      WLw, WLl,
                WLt-0.282, WLw, WLl+0.000,
                WLt-0.200, WLw, WLl+0.200)

cdrawtriangle3d(WRt,      WRw, WRl,
                WRt-0.282, WRw, WRl-0.000,
                WRt-0.200, WRw, WRl-0.200)

```

```

setcolour(maprgb(150,81,75))
cdrawquad3d(WRt-0.200, WRw, WRl-0.200,
            WRt-0.282, WRw, WRl-0.000,
            WLt-0.282, WLw, WLl-0.000,
            WLt-0.200, WLw, WLl-0.200)
setcolour(maprgb(180,50,104))
cdrawtriangle3d(WLt,      WLw, WLl,
               WLt-0.282, WLw, WLl-0.000,
               WLt-0.200, WLw, WLl-0.200)

cdrawtriangle3d(WRt,      WRw, WRl,      // Forward quadrant
               WRt+0.282, WRw, WRl+0.000,
               WRt+0.200, WRw, WRl+0.200)
setcolour(maprgb(150,81,75))
cdrawquad3d(WRt+0.200, WRw, WRl+0.200,
            WRt+0.282, WRw, WRl+0.000,
            WLt+0.282, WLw, WLl+0.000,
            WLt+0.200, WLw, WLl+0.200)
setcolour(maprgb(180,50,104))
cdrawtriangle3d(WLt,      WLw, WLl,
               WLt+0.282, WLw, WLl+0.000,
               WLt+0.200, WLw, WLl+0.200)
cdrawtriangle3d(WRt,      WRw, WRl,
               WRt+0.282, WRw, WRl-0.000,
               WRt+0.200, WRw, WRl-0.200)
setcolour(maprgb(150,81,75))
cdrawquad3d(WRt+0.200, WRw, WRl-0.200,
            WRt+0.282, WRw, WRl-0.000,
            WLt+0.282, WLw, WLl-0.000,
            WLt+0.200, WLw, WLl-0.200)
setcolour(maprgb(180,50,104))
cdrawtriangle3d(WLt,      WLw, WLl,
               WLt+0.282, WLw, WLl-0.000,
               WLt+0.200, WLw, WLl-0.200)

setcolour(maprgb(180,50,104))
cdrawtriangle3d(WRt,      WRw, WRl,      // Bottom quadrant
               WRt+0.000, WRw, WRl-0.282,
               WRt-0.200, WRw, WRl-0.200)
setcolour(maprgb(150,81,75))
cdrawquad3d(WRt+0.000, WRw, WRl-0.282,
            WRt-0.200, WRw, WRl-0.200,
            WLt-0.200, WLw, WLl-0.200,
            WLt+0.000, WLw, WLl-0.282)

```

```

setcolour(maprgb(180,50,104))
cdrawtriangle3d(WLt,      WLw, WLl,
                WLt+0.000, WLw, WLl-0.282,
                WLt-0.200, WLw, WLl-0.200)

setcolour(maprgb(180,50,104))
cdrawtriangle3d(WRt,      WRw, WRl,
                WRt+0.000, WRw, WRl-0.282,
                WRt+0.200, WRw, WRl-0.200)
setcolour(maprgb(150,81,75))
cdrawquad3d(WRt+0.000, WRw, WRl-0.282,
            WRt+0.200, WRw, WRl-0.200,
            WLt+0.200, WLw, WLl-0.200,
            WLt+0.000, WLw, WLl-0.282)
setcolour(maprgb(180,50,104))
cdrawtriangle3d(WLt,      WLw, WLl,
                WLt+0.000, WLw, WLl-0.282,
                WLt+0.200, WLw, WLl-0.200)
}

AND drawbody(FLT side) BE
{ LET FLT B1t, FLT B1w, FLT B1l = 6.0, side*0.50, 0.50
  LET FLT B2t, FLT B2w, FLT B2l = 6.0, side*0.30, -0.50
  LET FLT B3t, FLT B3w, FLT B3l = 3.2, side*1.00, -1.00
  LET FLT B4t, FLT B4w, FLT B4l = 2.5, side*1.00, 1.00
  LET FLT B5t, FLT B5w, FLT B5l = 1.8, side*0.70, 2.30
  LET FLT B6t, FLT B6w, FLT B6l = -0.5, side*0.70, 2.40
  LET FLT B7t, FLT B7w, FLT B7l = -1.0, side*1.00, 1.00
  LET FLT B8t, FLT B8w, FLT B8l = -1.0, side*1.00, -1.00
  LET FLT B9t, FLT B9w, FLT B9l = -12.0, side*0.06, -0.25
  LET FLT B10t, FLT B10w, FLT B10l = -12.0, side*0.06, +0.25

  // These vertices are numbered as follow

  //          5 - - - 6 - _
  //          /          \ - - - _
  //      _ - - 4 - - - - 7          - - - - - _
  //      1      |          |          - - - - - 10
  //      |      /          |          |
  //      2 _    |          |          - - - - - - - - - - - 9
  //          - 3 - - - - - 8 - - - - -

  setcolour(maprgb(164,160,114))
/*
  setcolour(maprgb(255,0,0))

```

```

    B1t, B1w, B1l := 2.0, 1.0, 0.0
    B2t, B2w, B2l := 2.0, 1.0, 3.0
    B3t, B3w, B3l := 6.0, 1.0, 0.0
newline()
writef("drawing triangle: %9.3f %9.3f %9.3f red*n", B1t, B1w, B1l)
writef("          %9.3f %9.3f %9.3f*n", B2t, B2w, B2l)
writef("          %9.3f %9.3f %9.3f*n", B3t, B3w, B3l)
    cdrawtriangle3d( B1t, B1w, B1l, // Engine
                    B2t, B2w, B2l,
                    B3t, B3w, B3l)
    setcolour(maprgb(0,0,255))
    B1t, B1w, B1l := 2.0, -1.0, 0.0
    B2t, B2w, B2l := 2.0, -1.0, 3.0
    B3t, B3w, B3l := 6.0, -1.0, 0.0
newline()
writef("drawing triangle: %9.3f %9.3f %9.3f blue*n", B1t, B1w, B1l)
writef("          %9.3f %9.3f %9.3f*n", B2t, B2w, B2l)
writef("          %9.3f %9.3f %9.3f*n", B3t, B3w, B3l)
    cdrawtriangle3d( B1t, B1w, B1l, // Engine
                    B2t, B2w, B2l,
                    B3t, B3w, B3l)

RETURN
*/
//newline()
//writef("drawing triangle: %9.3f %9.3f %9.3f*n", B1t, B1w, B1l)
//writef("          %9.3f %9.3f %9.3f*n", B2t, B2w, B2l)
//writef("          %9.3f %9.3f %9.3f*n", B3t, B3w, B3l)
    cdrawtriangle3d( B1t, B1w, B1l, // Engine
                    B2t, B2w, B2l,
                    B3t, B3w, B3l)

//updatescreen()
//abort(369)

    setcolour(maprgb(154,178,104))
    cdrawtriangle3d( B1t, B1w, B1l,
                    B3t, B3w, B3l,
                    B4t, B4w, B4l)
    setcolour(maprgb(190,190,170))
// setcolour(maprgb(0,0,255))
    cdrawtriangle3d( B4t, B4w, B4l, // Cockpit
                    B5t, B5w, B5l,
                    B7t, B7w, B7l)
    cdrawtriangle3d( B5t, B5w, B5l,
                    B6t, B6w, B6l,

```



```

        B7t, B7w, B7l)

setcolour(maprgb(144,168,124))
cdrawtriangle3d( B3t, B3w, B3l,
                 B4t, B4w, B4l,
                 B7t, B7w, B7l)
cdrawtriangle3d( B3t, B3w, B3l,
                 B7t, B7w, B7l,
                 B8t, B8w, B8l)

setcolour(maprgb(164,160,114))

cdrawtriangle3d( B8t, B8w, B8l, // Tail
                 B7t, B7w, B7l,
                 B9t, B9w, B9l)
setcolour(maprgb(154,168,114))
cdrawtriangle3d( B7t, B7w, B7l,
                 B9t, B9w, B9l,
                 B10t, B10w, B10l)
setcolour(maprgb(164,178,114))
cdrawtriangle3d( B7t, B7w, B7l,
                 B6t, B6w, B6l,
                 B10t, B10w, B10l)

IF side>0.0 DO
{ // Draw midline panels

    setcolour(maprgb(120,120,120))
    cdrawtriangle3d( B1t, B1w, B1l, // Engine front
                    B2t, B2w, B2l,
                    B2t, -B2w, B2l)
    cdrawtriangle3d( B1t, B1w, B1l,
                    B2t, -B2w, B2l,
                    B1t, -B1w, B1l)
    setcolour(maprgb(174,158,154))
    cdrawtriangle3d( B1t, B1w, B1l, // Engine top
                    B1t, -B1w, B1l,
                    B4t, B4w, B4l)
    cdrawtriangle3d( B1t, -B1w, B1l,
                    B4t, -B4w, B4l,
                    B4t, B4w, B4l)
    setcolour(maprgb(220,220,220))
    cdrawtriangle3d( B4t, B4w, B4l, // Wind shield
                    B4t, -B4w, B4l,
                    B5t, B5w, B5l)

```

```

cdrawtriangle3d( B4t, -B4w, B4l,
                 B5t, -B5w, B5l,
                 B5t, B5w, B5l)
setcolour(maprgb(164,158,134))
//setcolour(maprgb(255,0,0))
cdrawtriangle3d( B5t, B5w, B5l, // Cockpit top
                 B6t, B6w, B6l,
                 B6t, -B6w, B6l)
//setcolour(maprgb(0,0,255))
cdrawtriangle3d( B5t, B5w, B5l,
                 B5t, -B5w, B5l,
                 B6t, -B6w, B6l)
setcolour(maprgb(154,148,144))
cdrawtriangle3d( B6t, B6w, B6l, // Tail top
                 B10t, B10w, B10l,
                 B10t, -B10w, B10l)
cdrawtriangle3d( B6t, B6w, B6l,
                 B6t, -B6w, B6l,
                 B10t, -B10w, B10l)

setcolour(maprgb(184,178,84))
cdrawtriangle3d( B9t, B9w, B9l, // Tail end
                 B10t, B10w, B10l,
                 B10t, -B10w, B10l)
cdrawtriangle3d( B9t, B9w, B9l,
                 B9t, -B9w, B9l,
                 B10t, -B10w, B10l)

setcolour(maprgb(134,148,144))
cdrawtriangle3d( B8t, B8w, B8l, // Tail bottom surface
                 B8t, -B8w, B8l,
                 B9t, B9w, B9l)
cdrawtriangle3d( B8t, -B8w, B8l,
                 B9t, -B9w, B9l,
                 B9t, B9w, B9l)

setcolour(maprgb(144,168,134))
cdrawtriangle3d( B3t, B3w, B3l, // Cockpit bottom surface
                 B3t, -B3w, B3l,
                 B8t, B8w, B8l)
cdrawtriangle3d( B3t, -B3w, B3l,
                 B8t, -B8w, B8l,
                 B8t, B8w, B8l)

setcolour(maprgb(144,148,114))

```

```

    cdrawingtriangle3d( B2t, B2w, B2l, // Engine bottom surface
                       B2t, -B2w, B2l,
                       B3t, B3w, B3l)
    cdrawingtriangle3d( B2t, -B2w, B2l,
                       B3t, -B3w, B3l,
                       B3t, B3w, B3l)

    drawwheel(4.0, 0.0, -0.9)
  }
}

AND drawing(FLT side) BE
{ LET FLT W1t, FLT W1w, FLT W1l = 3.0, side*1.00, -1.00
  LET FLT W2t, FLT W2w, FLT W2l = 1.5, side*1.00, -0.55
  LET FLT W3t, FLT W3w, FLT W3l = 1.5, side*1.00, -1.00
  LET FLT W4t, FLT W4w, FLT W4l = -1.0, side*1.00, -0.90
  LET FLT W5t, FLT W5w, FLT W5l = -1.0, side*1.00, -1.00
  LET FLT W6t, FLT W6w, FLT W6l = -1.8, side*1.40, -1.00 // Aileron near edge
  LET FLT W7t, FLT W7w, FLT W7l = -2.8, side*11.30, 0.40 // Aileron near edge
  LET FLT W8t, FLT W8w, FLT W8l = -2.0, side*12.20, 0.60
  LET FLT W9t, FLT W9w, FLT W9l = -2.0, side*12.20, 0.50
  LET FLT W10t, FLT W10w, FLT W10l = -0.3, side*12.50, 0.85
  LET FLT W11t, FLT W11w, FLT W11l = -0.3, side*12.50, 0.65
  LET FLT W12t, FLT W12w, FLT W12l = 1.3, side*11.50, 0.55

  //      12-----1
  //      /                               |
  // 10/11      Left wing                2/3
  //      |                               |
  //      8/9-----4/5
  //      7-----6

  W6l := W6l + side*sinaileron*0.8 // Aileron adjustment
  W6t := W6t + side*(1.0-cosaileron)*0.8
  W7l := W7l + side*sinaileron*0.8
  W7t := W7t + side*(1.0-cosaileron)*0.8

  colour(120,150,140)
  //IF side = Left DO colour(255,0,0) // Debugging code
  //IF side = Right DO colour(0,255,0)

  cdrawingtriangle3d(W1t, W1w, W1l, // Top surface
                    W2t, W2w, W2l,
                    W12t, W12w, W12l)
  cdrawingtriangle3d(W2t, W2w, W2l,

```

```

                W10t, W10w, W10l,
                W12t, W12w, W12l)
colour(100,160,120)
cdrawtriangle3d(W2t,  W2w,  W2l,
                W4t,  W4w,  W4l,
                W10t, W10w, W10l)
cdrawtriangle3d(W4t,  W4w,  W4l,
                W10t, W10w, W10l,
                W8t,  W8w,  W8l)
colour(130,150,130)
cdrawtriangle3d(W4t,  W4w,  W4l,
                W8t,  W8w,  W8l,
                W6t,  W6w,  W6l)
cdrawtriangle3d(W8t,  W8w,  W8l,
                W6t,  W6w,  W6l,
                W7t,  W7w,  W7l)

colour(120,160,70)
cdrawtriangle3d(W1t,  W1w,  W1l,  // Bottom surface
                W3t,  W3w,  W3l,
                W12t, W12w, W12l)
colour(110,150,80)
cdrawtriangle3d(W3t,  W3w,  W3l,
                W11t, W11w, W11l,
                W12t, W12w, W12l)
colour(120,150,80)
cdrawtriangle3d(W3t,  W3w,  W3l,
                W5t,  W5w,  W5l,
                W11t, W11w, W11l)
colour(130,160,70)
cdrawtriangle3d(W5t,  W5w,  W5l,
                W11t, W11w, W11l,
                W9t,  W9w,  W9l)
colour(120,170,65)
cdrawtriangle3d(W5t,  W5w,  W5l,
                W9t,  W9w,  W9l,
                W6t,  W6w,  W6l)
colour(110,160,75)
cdrawtriangle3d(W9t,  W9w,  W9l,
                W6t,  W6w,  W6l,
                W7t,  W7w,  W7l)

colour(130,100,100)
cdrawtriangle3d(W4t, W4w, W4l,  // Root end triangles
                W5t, W5w, W5l,
```

```

        W6t, W6w, W6l)
colour(140,120,60)
cdrawtriangle3d(W10t, W10w, W10l, // Tip end triangles
               W11t, W11w, W11l,
               W12t, W12w, W12l)
colour(130,130,60)
cdrawtriangle3d(W10t, W10w, W10l,
               W11t, W11w, W11l,
               W8t, W8w, W8l)
colour(140,130,70)
cdrawtriangle3d(W8t, W8w, W8l,
               W9t, W9w, W9l,
               W11t, W11w, W11l)
colour(120,120,80)
cdrawtriangle3d(W7t, W7w, W7l, // Aileron tip
               W8t, W8w, W8l,
               W9t, W9w, W9l)

drawwheel(-0.7, side*2.0, -0.9)

}

AND drawelevator(FLT side) BE
{ LET FLT E1t, FLT E1w, FLT E1l = -10.0, side*0.00, 0.00
  LET FLT E2t, FLT E2w, FLT E2l = -12.0, side*0.10, 0.05
  LET FLT E3t, FLT E3w, FLT E3l = -12.0, side*0.10, -0.05
  LET FLT E4t, FLT E4w, FLT E4l = -12.7, side*0.70, 0.00
  LET FLT E5t, FLT E5w, FLT E5l = -12.7, side*3.50, 0.00
  LET FLT E6t, FLT E6w, FLT E6l = -12.0, side*4.05, 0.05
  LET FLT E7t, FLT E7w, FLT E7l = -12.0, side*4.05, -0.05
  LET FLT E8t, FLT E8w, FLT E8l = -11.1, side*3.75, 0.00

  //      8-----1
  //      / Elevator |
  //      6/7-----2/3
  //      \           /
  //      5-----4

  E4l := E4l - sinelevator*0.7 // Elevator adjustment
  E4t := E4t + (1.0-coselevator)*0.7
  E5l := E5l - sinelevator*0.7
  E5t := E5t + (1.0-coselevator)*0.7

  colour(133,155,70)
  cdrawtriangle3d(E1t, E1w, E1l, // Top surface

```

```

                E2t, E2w, E2l,
                E6t, E6w, E6l)
colour(155,178,90)
cdrawtriangle3d(E1t, E1w, E1l,
                E6t, E6w, E6l,
                E8t, E8w, E8l)
colour(154,150,60)
cdrawtriangle3d(E2t, E2w, E2l,
                E4t, E4w, E4l,
                E5t, E5w, E5l)
cdrawtriangle3d(E2t, E2w, E2l,
                E5t, E5w, E5l,
                E6t, E6w, E6l)

colour(140,150,80)
cdrawtriangle3d(E1t, E1w, E1l, // Bottom surface
                E3t, E3w, E3l,
                E7t, E7w, E7l)
colour(120,140,105)
cdrawtriangle3d(E1t, E1w, E1l,
                E7t, E7w, E7l,
                E8t, E8w, E8l)
colour(150,150,80)
cdrawtriangle3d(E3t, E3w, E3l,
                E4t, E4w, E4l,
                E5t, E5w, E5l)
cdrawtriangle3d(E3t, E3w, E3l,
                E5t, E5w, E5l,
                E7t, E7w, E7l)

colour(130,100,120)
cdrawtriangle3d(E2t, E2w, E2l, // end triangles
                E3t, E3w, E3l,
                E4t, E4w, E4l)
colour(140,130,160)
cdrawtriangle3d(E6t, E6w, E6l,
                E7t, E7w, E7l,
                E5t, E5w, E5l)
colour(150,120,160)
cdrawtriangle3d(E6t, E6w, E6l,
                E7t, E7w, E7l,
                E8t, E8w, E8l)
}

AND colour(r,g,b) BE setcolour(maprgb(r,g,b))

```

```

AND drawfin(FLT side) BE
{ LET FLT F1t, FLT F1w, FLT F1l = -10.0, side*0.00, 0.25
  LET FLT F2t, FLT F2w, FLT F2l = -12.0, side*0.05,-0.25
  LET FLT F3t, FLT F3w, FLT F3l = -12.7, side*0.00, 0.00
  LET FLT F4t, FLT F4w, FLT F4l = -12.7, side*0.00, 2.00
  LET FLT F5t, FLT F5w, FLT F5l = -12.0, side*0.05, 2.50
  LET FLT F6t, FLT F6w, FLT F6l = -11.3, side*0.00, 2.50

  //          6----5
  //         /      | \
  //        / side | 4
  //       /  of  | |
  //      /   fin | 3
  //     1____   | /
  //          ----2

  F3w := F3w - sinrudder*0.7      // Rudder adjustment
  F3t := F3t + (1.0-cosrudder)*0.7
  F4w := F4w - sinrudder*0.7
  F4t := F4t + (1.0-cosrudder)*0.7

  colour(135,135,100)
  cdrawtriangle3d(F1t, F1w, F1l,
                  F2t, F2w, F2l,
                  F6t, F6w, F6l)
  colour(135,145,120)
  cdrawtriangle3d(F2t, F2w, F2l,
                  F5t, F5w, F5l,
                  F6t, F6w, F6l)
  colour(165,155,110)
  cdrawtriangle3d(F2t, F2w, F2l,
                  F5t, F5w, F5l,
                  F3t, F3w, F3l)
  cdrawtriangle3d(F4t, F4w, F4l,
                  F5t, F5w, F5l,
                  F3t, F3w, F3l)

  IF side>0 DO
  { colour(105,135,120)
    cdrawtriangle3d(F2t, F2w, F2l, // Fin end triangles
                    F2t,-F2w, F2l,
                    F3t, F3w, F3l)
    cdrawtriangle3d(F5t, F5w, F5l,
                    F5t,-F5w, F5l,

```

```

        F4t, F4w, F4l)
colour(135,125,130)
cdrawtriangle3d(F5t, F5w, F5l,
               F5t,-F5w, F5l,
               F6t, F6w, F6l)

}

}

AND cdrawquad3d(FLT t1, FLT w1, FLT l1,
               FLT t2, FLT w2, FLT l2,
               FLT t3, FLT w3, FLT l3,
               FLT t4, FLT w4, FLT l4) BE
{ // The rotation matrix used by screencoords is already set
  // by setaircraftmat or setgroundmat in

  //      ( m00 m01 m02 )
  //      ( m10 m11 m12 )
  //      ( m20 m21 m22 )

  // Screen coordinates of the four vertices.
  LET FLT sx1, FLT sy1, FLT sz1 = ?,?,?
  LET FLT sx2, FLT sy2, FLT sz2 = ?,?,?
  LET FLT sx3, FLT sy3, FLT sz3 = ?,?,?
  LET FLT sx4, FLT sy4, FLT sz4 = ?,?,?

  // Calculate the screen coordinates
  UNLESS screencoords(t1, w1, l1, @sx1) RETURN
  UNLESS screencoords(t2, w2, l2, @sx2) RETURN
  UNLESS screencoords(t3, w3, l3, @sx3) RETURN
  UNLESS screencoords(t4, w4, l4, @sx4) RETURN

  //writef("cdrawtri3d: %13.3f %13.3f %13.3f*\n", t1, w1, l1)
  //writef("          %13.3f %13.3f %13.3f*\n", t2, w2, l2)
  //writef("          %13.3f %13.3f %13.3f*\n", t3, w3, l3)
  //writef("          %13.3f %13.3f %13.3f*\n", t4, w4, l4)

  //writef("cetn=%6.3f cewn=%6.3f celn=%6.3f*\n", cetn, cewn, celn)
  //writef("cetw=%6.3f ceww=%6.3f celw=%6.3f*\n", cetw, ceww, celw)
  //writef("ceth=%6.3f cewh=%6.3f celh=%6.3f*\n", ceth, cewh, celh)

  //writef("ctn=%6.3f cwn=%6.3f cln=%6.3f*\n", ctn, cwn, cln)
  //writef("ctw=%6.3f cww=%6.3f clw=%6.3f*\n", ctw, cww, clw)
  //writef("cth=%6.3f cwh=%6.3f clh=%6.3f*\n", cth, cwh, clh)

```



```

//writef("m00=%6.3f m01=%6.3f m02=%6.3f*n", m00, m01, m02)
//writef("m10=%6.3f m11=%6.3f m12=%6.3f*n", m10, m11, m12)
//writef("m20=%6.3f m21=%6.3f m22=%6.3f*n", m20, m21, m22)

//writef("sx1=%5i sy1=%5i sz1=%13.1f*n", FIX sx1, FIX sy1, sz1)
//writef("sx2=%5i sy2=%5i sz2=%13.1f*n", FIX sx2, FIX sy2, sz2)
//writef("sx3=%5i sy3=%5i sz2=%13.1f*n", FIX sx3, FIX sy3, sz3)
//writef("sx4=%5i sy4=%5i sz4=%13.1f*n", FIX sx4, FIX sy4, sz4)
//newline()

    drawquad3d(FIX sx1, FIX sy1, sz1,
               FIX sx2, FIX sy2, sz2,
               FIX sx3, FIX sy3, sz3,
               FIX sx4, FIX sy4, sz4)

//updatescreen()
//abort(2468)
}

AND cdrawtriangle3d(FLT t1, FLT w1, FLT l1,
                   FLT t2, FLT w2, FLT l2,
                   FLT t3, FLT w3, FLT l3) BE
{ // The rotation matrix used by screencoords is already set
  // by setaircraftmat or setgroundmat in

  //      ( m00 m01 m02 )
  //      ( m10 m11 m12 )
  //      ( m20 m21 m22 )

  // Screen coordinates of the three vertices.
  LET FLT sx1, FLT sy1, FLT sz1 = ?,?,?
  LET FLT sx2, FLT sy2, FLT sz2 = ?,?,?
  LET FLT sx3, FLT sy3, FLT sz3 = ?,?,?

  // Calculate the screen coordinates
  UNLESS screencoords(t1, w1, l1, @sx1) RETURN
  UNLESS screencoords(t2, w2, l2, @sx2) RETURN
  UNLESS screencoords(t3, w3, l3, @sx3) RETURN

//writef("cdrawtri3d: %13.3f %13.3f %13.3f*n", t1, w1, l1)
//writef("          %13.3f %13.3f %13.3f*n", t2, w2, l2)
//writef("          %13.3f %13.3f %13.3f*n", t3, w3, l3)

//writef("cetn=%6.3f cewn=%6.3f celn=%6.3f*n", cetn, cewn, celn)

```

```

//writef("cetw=%6.3f ceww=%6.3f celw=%6.3f*n", cetw, ceww, celw)
//writef("ceth=%6.3f cewh=%6.3f celh=%6.3f*n", ceth, cewh, celh)

//writef("ctn=%6.3f cwn=%6.3f cln=%6.3f*n", ctn, cwn, cln)
//writef("ctw=%6.3f cww=%6.3f clw=%6.3f*n", ctw, cww, clw)
//writef("cth=%6.3f cwh=%6.3f clh=%6.3f*n", cth, cwh, clh)

//writef("m00=%6.3f m01=%6.3f m02=%6.3f*n", m00, m01, m02)
//writef("m10=%6.3f m11=%6.3f m12=%6.3f*n", m10, m11, m12)
//writef("m20=%6.3f m21=%6.3f m22=%6.3f*n", m20, m21, m22)

//writef("sx1=%5i sy1=%5i sz1=%13.1f*n", FIX sx1, FIX sy1, sz1)
//writef("sx2=%5i sy2=%5i sz2=%13.1f*n", FIX sx2, FIX sy2, sz2)
//writef("sx3=%5i sy3=%5i sz2=%13.1f*n", FIX sx3, FIX sy3, sz3)
//newline()

    drawtriangle3d(FIX sx1, FIX sy1, sz1,
                  FIX sx2, FIX sy2, sz2,
                  FIX sx3, FIX sy3, sz3)

//updatescreen()
//abort(2468)
}

AND setaircraftmat() BE
{ // It is easy to see that

    // ( ctn ctw cth )   ( N )   ( t )
    // ( cwn cww cwh ) x ( W ) => ( w )       (equation 1)
    // ( cln clw clh )   ( H )   ( l )

    // where (N,W,H) are the real world coordinates of a
    // vertex and (t,w,l) are its coordinates with respect
    // to the aircraft axes with the same origin. To convert
    // aircraft coordinates to world coordinates we need the
    // inverse matrix, but this is simple since, in this
    // case, it just turns out to be its transpose.

    // ( ctn cwn cln )   ( t )   ( N )
    // ( ctw cww clw ) x ( w ) => ( W )
    // ( cth cwh clh )   ( l )   ( H )

    // We can see this by multiplying both sides of equation 1
    // by the transposed matrix.

```

```

// ( ctn cwn cln )   ( ctn ctw cth )   ( N )
// ( ctw cww clw ) x ( cwn cww cwh ) x ( W ) =>
// ( cth cwh clh )   ( cln clw clh )   ( H )

//
//           ( ctn cwn cln )   ( t )
//           ( ctw cww clw ) x ( w )
//           ( cth cwh clh )   ( l )

// The product of the two matrices on the left reduces to
// the identity matrix since their elements are all direction
// cosines of orthogonal unit vectors.

// The rotation matrix required by screencoords for vertices in
// the aircraft model is thus

// ( cetn cetw ceth )   ( ctn cwn cln )   ( m00 m01 m02 )
// ( cewn ceww cewh ) x ( ctw cww clw ) => ( m10 m11 m12 )
// ( celn celw celh )   ( cth cwh clh )   ( m20 m21 m22 )

m00 := cetn*ctn + cetw*ctw + ceth*cth
m01 := cetn*cwn + cetw*cww + ceth*cwh
m02 := cetn*cln + cetw*clw + ceth*clh

m10 := cewn*ctn + ceww*ctw + cewh*cth
m11 := cewn*cwn + ceww*cww + cewh*cwh
m12 := cewn*cln + ceww*clw + cewh*clh

m20 := celn*ctn + celw*ctw + celh*cth
m21 := celn*cwn + celw*cww + celh*cwh
m22 := celn*cln + celw*clw + celh*clh

//writef("nsetaircraftmat:*n")
//writef("          cetn=%9.3f  cetw=%9.3f  ceth=%9.3f*n", cetn,cetw,ceth)
//writef("          cewn=%9.3f  ceww=%9.3f  cewh=%9.3f*n", cewn,ceww,cewh)
//writef("          celn=%9.3f  celw=%9.3f  celh=%9.3f*n", celn,celw,celh)

//newline()
//writef("          ctn=%9.3f   ctw=%9.3f   cth=%9.3f*n", ctn,ctw,cth)
//writef("          cwn=%9.3f   cww=%9.3f   cwh=%9.3f*n", cwn,cww,cwh)
//writef("          cln=%9.3f   clw=%9.3f   clh=%9.3f*n", cln,clw,clh)

//writef("Transposed*n")
//writef("          ctn=%9.3f   ctw=%9.3f   cth=%9.3f*n", ctn,cwn,cln)
//writef("          cwn=%9.3f   cww=%9.3f   cwh=%9.3f*n", ctw,cww,clw)
//writef("          cln=%9.3f   clw=%9.3f   clh=%9.3f*n", cth,cwh,clh)

```

```
//newline()
//writef("          m00=%9.3f  m01=%9.3f  m02=%9.3f*n", m00,m01,m02)
//writef("          m10=%9.3f  m11=%9.3f  m12=%9.3f*n", m10,m11,m12)
//writef("          m20=%9.3f  m21=%9.3f  m22=%9.3f*n", m20,m21,m22)
}
```

```
AND setgroundmat() BE
{ // For ground points no aircraft rotation is necessary, so

  // ( cetn cetw ceth )    ( m00 m01 m02 )
  // ( cewn ceww cewh ) => ( m10 m11 m12 )
  // ( celn celw celh )    ( m20 m21 m22 )

  m00, m01, m02 := cetn, cetw, ceth
  m10, m11, m12 := cewn, ceww, cewh
  m20, m21, m22 := celn, celw, celh
}
```

```
AND screencoords(FLT x, FLT y, FLT z, v) = VALOF
{ // (x,y,z) are either the coordinates of a vertex in the aircraft
  // model or the coordinates of a point on the ground using
  // (cgn,cgw,cgh) as the origin. The eye is looking directly
  // at this origin. If the point is in view its screen coordinates
  // are placed in v!0, v!1 and v!2 and the result is TRUE. If the
  // point is not in view the result is FALSE.
  // The one or two rotations are performed by multiplying the
  // point by the matrix
  //      ( m00 m01 m02 )
  //      ( m10 m11 m12 )
  //      ( m20 m21 m22 )
```

```
LET FLT sizeby2 = (fscreenxsize<=fscreenysize ->
                  fscreenxsize, fscreenysize) / 2.0
```

```
LET FLT mx = fscreenxsize / 2.0 // The mid point of the screen
LET FLT my = fscreenysize / 2.0
```

```
LET FLT sx, FLT sy, FLT sz = ?, ?, ?
```

```
// Deal with eye orientation
sz := m00*x + m01*y + m02*z + eyedist // Positive depth
```

```
IF sz < 1.0 DO
```

```
{ // The point is behind the eye or less than 1 ft in front
```

```

    RESULTIS FALSE
}

sx := mx - sizeby2 * (m10*x + m11*y + m12*z) / sz // Horizontal
sy := my + sizeby2 * (m20*x + m21*y + m22*z) / sz // Vertical

//newline()
//writef("screencoords: x=%9.3f      y=%9.3f      z=%9.3f*n", x,y,z)
//newline()
//writef("          cetn=%9.3f  cetw=%9.3f  ceth=%9.3f*n", cetn,cetw,ceth)
//writef("          cewn=%9.3f  ceww=%9.3f  cewh=%9.3f*n", cewn,ceww,cewh)
//writef("          celn=%9.3f  celw=%9.3f  celh=%9.3f*n", celn,celw,celh)

//newline()
//writef("          ctn=%9.3f   ctw=%9.3f   cth=%9.3f*n", ctn,ctw,cth)
//writef("          cwn=%9.3f   cww=%9.3f   cwh=%9.3f*n", cwn,cww,cwh)
//writef("          cln=%9.3f   clw=%9.3f   clh=%9.3f*n", cln,clw,clh)

//writef("Transposed*n")
//writef("          ctn=%9.3f   ctw=%9.3f   cth=%9.3f*n", ctn,cwn,cln)
//writef("          cwn=%9.3f   cww=%9.3f   cwh=%9.3f*n", ctw,cww,clw)
//writef("          cln=%9.3f   clw=%9.3f   clh=%9.3f*n", cth,cwh,clh)

//newline()
//writef("          m00=%9.3f   m01=%9.3f   m02=%9.3f*n", m00,m01,m02)
//writef("          m10=%9.3f   m11=%9.3f   m12=%9.3f*n", m10,m11,m12)
//writef("          m20=%9.3f   m21=%9.3f   m22=%9.3f*n", m20,m21,m22)

// If the resulting (x,y) coordinate are not on the screen return FALSE
UNLESS 0.0 <= sx < fscreenxsize &
       0.0 <= sy < fscreenysize RESULTIS FALSE

// A point screensize pixels away from the centre of the screen is
// 45 degrees from the direction of view.
// Note that many pixels in this range are off the screen.
v!0 := sx
v!1 := sy
v!2 := -sz // This distance into the screen in arbitrary units, used
           // for hidden surface removal.

//newline()
//writef("          sizeby2=%9.3f   mx=%9.3f   my=%9.3f*n", sizeby2, mx, my)
//writef("          v!0=%9.3f   v!1=%9.3f   v!2=%9.3f*n", v!0, v!1, v!2)
//abort(1119)
    RESULTIS TRUE
}

```

```

AND gdrawquad3d(FLT x1, FLT y1, FLT z1,
                FLT x2, FLT y2, FLT z2,
                FLT x3, FLT y3, FLT z3,
                FLT x4, FLT y4, FLT z4) BE
{ cdrawquad3d(x1-cgn, y1-cgw, z1-cgh,
              x2-cgn, y2-cgw, z2-cgh,
              x3-cgn, y3-cgw, z3-cgh,
              x4-cgn, y4-cgw, z4-cgh)
}

AND gdrawtriangle3d(FLT x1, FLT y1, FLT z1,
                   FLT x2, FLT y2, FLT z2,
                   FLT x3, FLT y3, FLT z3) BE
{ cdrawtriangle3d(x1-cgn, y1-cgw, z1-cgh,
                  x2-cgn, y2-cgw, z2-cgh,
                  x3-cgn, y3-cgw, z3-cgh)
}

AND plotscreen() BE
{ fillsurf(maprgb(100,100,255))
  //seteyeposition()
  cleardepthscreen()

  //ctn, ctw, cth := 1.0, 0.0, 0.0 // Aircraft orientation pointing due north
  //cwn, cww, cwh := 0.0, 1.0, 0.0
  //cln, clw, clh := 0.0, 0.0, 1.0

  //cetn, cetw, ceth := 1.0, 0.0, 0.0 // Eye orientation pointing due north
  //cewn, ceww, cewh := 0.0, 1.0, 0.0
  //celn, celw, celh := 0.0, 0.0, 1.0

  //cgn, cgw, cgh := 0, 0, 0

  plotcraft()
  plotland()
}

AND orthocoords(FLT n, FLT w, FLT h, v) = VALOF
{ // (n,w,h) is a point relative to (cgn,cgw,cgh).
  // It is viewed with orientation (t,w,l) using an orthogonal projection.
  // The screen (x,y) coordinates are placed in v!0 and v!1.
  // The result is TRUE if (n,w,h) is in front.
  LET sx, sy = 0.0, 0.0

```

```

LET res = FALSE

// Screen z is the inner product of (n,w,h) and (ctn,ctw,cth)
IF n*ctn + w*ctw + h*cth > 0.0 DO
{ // The direction of motion circle is in front
  // Screen x is the inner product of (n,w,h) and (cwn,cww,cwh)
  sx := n*cwn + w*cww + h*cwh
  // Screen y is the inner product of (n,w,h) and (cln,clw,clh)
  sy := n*cln + w*clw + h*clh
  res := TRUE

  //writef("orthocoords:*n")
  //writef(" ctn=%6.3f ctw=%6.3f cth=%6.3f*n", ctn,ctw,cth)
  //writef(" cwn=%6.3f cww=%6.3f cwh=%6.3f*n", cwn,cww,cwh)
  //writef(" cln=%6.3f clw=%6.3f clh=%6.3f*n", cln,clw,clh)
  //writef(" n=%13.3f w=%13.3f h=%13.3f*n", n,w,h)
  //writef("sx=%13.3f sy=%13.3f*n", sx,sy)
  v!0 := FIX(fscreenxsize - 100 - sx)
  v!1 := FIX(fscreenysize * 0.5 + sy)
  //writef("v!0=%6i v!1=%6i*n", v!0,v!1)
  RESULTIS TRUE
}

v!0 := -1
v!1 := -1
//writef("v!0=%6i v!1=%6i*n", v!0,v!1)
RESULTIS FALSE
}

AND draw_artificial_horizon() BE
{ // This function draws the artificial horizon and a small circle
  // representing the direction of travel.
  // The n and w components of the direction of thrust t are used
  // to make a horizontal vector (n,w,0) which is above or below
  // the direction of thrust. This is then scaled to make it of
  // unit length. Suppose the resulting vector is d = (dn,dw,0).
  // Let P be a point in direction d 100 ft from the aircraft's CG,
  // ie (100dn, 100dw,0). This point will be above of below the
  // line in direction t from the CG.
  // P (cgn+100dn,cgw+100dw,cgh) is in world coordinates.
  // The artificial horizon is made up of four line segments
  // A-B, B-C, C-D and D-E where A, B, D and E are on
  // the horizontal line passing through P at right angles to d.
  // A is 30ft to the left of P and E is 30ft to the right of P.
  // On the screen, B, C and D form an equilateral triangle half

```

```

// way between A and E.

// The direction of motion is represented by a small circle at
// point X which has coordinates (cgn+100xn,cgw+100xw,cgh+100xh)
// where (xn,xw,xh) is a unit vector in direction
// (cgndot,cgwdot,cghdot). The screen position of X is calculated
// using the same orthogonal projection as the points A, B, C, D
// and E.

LET px, py = ?, ? // For screen coordinates
LET ax, ay = ?, ? // For screen coordinates
LET bx, by = ?, ? // For screen coordinates
LET cx, cy = ?, ? // For screen coordinates
LET dx, dy = ?, ? // For screen coordinates
LET ex, ey = ?, ? // For screen coordinates
LET FLT n, FLT w, FLT h = ctn, ctw, 0.0 // A horizontal vector
LET FLT a, FLT b, FLT c = ?, ?, ? // Unit vector orthogonal to (n,w,h)
LET FLT Pn, FLT Pw, FLT Ph = ?, ?, ?
LET FLT An, FLT Aw, FLT Ah = ?, ?, ?
LET FLT En, FLT Ew, FLT Eh = ?, ?, ?
LET FLT Xn, FLT Xw, FLT Xh = ?, ?, ? // A point in direction
// (cgndot,cgwdot,cghdot).

setcolour(col_white)

//{ moveto(100,200)
// drawto(110,210)
//}
//updatescreen()
//abort(1002)

adjustlength(@n) // Make (n,w,0) a unit vector, direction d.

// Make a unit vector in direction A->E (orthogonal to d).
a, b, c := w, -n, 0.0

// Set P to be 100ft from CG in direction d
Pn, Pw, Ph := cgn+100*n, cgw+100*w, cgh // A point on the horizon
// 100ft from CG.

// Set A 30ft left of from P.
An, Aw, Ah := Pn-30*a, Pw-30*b, Ph
// Set A 30ft left of from P.
En, Ew, Eh := Pn+30*a, Pw+30*b, Ph

```



```

//      A-----B P D-----E
//              \  /
//              C
//
// AE is othogonal to the line from CG to P.
//

orthocoords(An-cgn, Aw-cgw, Ah-cgh, @ax)
orthocoords(En-cgn, Ew-cgw, Eh-cgh, @ex)
px, py := (ax+ex)/2, (ay+ey)/2
bx, by := px + (ax-ex)*5/60, py + (ay-ey)*5/60
dx, dy := px - (ax-ex)*5/60, py - (ay-ey)*5/60
// BCD is an equilateral triangle with sides of length 10,
// CP has length appoximately 8.66.
// (ey-ay, ax-ay) is a vector of length 60 in direction PC
// so the screen coordinates of C can be calculated as follows.
cx, cy := px+(ey-ay)*8_66/60_00, py+(ax-ex)*8_66/60_00
// We can now draw the artificial horizon
moveto(ax,ay)
drawto(bx,by)
drawto(cx,cy)
drawto(dx,dy)
drawto(ex,ey)

// Set (n,w,h) to be a point in direction (cgndot,cgwdot,cghdot).
n, w, h := cgndot, cgwdot, cghdot
// Make (n,w,h) a unit vector
adjustlength(@n)
// X is the centre of the direction of motion circle.
Xn, Xw, Xh := cgn+100*n, cgw+100*w, cgh+100*h

//plotf(20, 85, "Xn=%i6 Xw=%i6 Dn=%i6", FIX (Xn-cgn), FIX (Xw-cgw), FIX (Xh-cgh))
IF orthocoords(Xn-cgn, Xw-cgw, Xh-cgh, @px) D0
{ drawcircle(px, py, 5)
//writef("Draw circle at %n %n*n", px,py)
}
//updatescreen()
//abort(1001)
}

AND draw_ground_point(FLT x, FLT y) BE
{ LET FLT gx, FLT gy, FLT gz = Zro, Zro, Zro
//newline()
//writef("draw_ground_point: x=%13.2f y=%13.2f*n", x, y)
}

```

```

//writef("draw_ground_point: cgn=%13.2f cgw=%13.2f cgh=%13.2f*n", cgn, cgw, cgh)
//abort(1001)
  IF screencoords(x-cgn, y-cgw, -cgh-cockpit1, @gx) DO
  {
//writef("gx=%13.3f gy=%13.3f gz=%13.3f*n", gx, gy, gz)
    drawrect(FIX gx, FIX gy, 2 + FIX gx, 2 + FIX gy)
    //updatescreen()
//abort(1000)
  }
}

```

```

AND drawgroundpoints() BE
{
  setcolour(col_red)
  gdrawquad3d( 0.0,   -5.0,  1.0,
              20.0,   -5.0,  1.0,
              20.0,    5.0,  1.0,
              0.0,    5.0,  1.0)
  setcolour(col_green)
  gdrawquad3d(20.0,   -5.0,  1.0,
              40.0,   -5.0,  1.0,
              40.0,    5.0,  1.0,
              20.0,    5.0,  1.0)
// updatescreen()

//IF FALSE DO
  FOR x = 0 TO 200-150 BY 20 DO
  { LET FLT fx = FLOAT x
    FOR y = -50 TO 45 BY 5 DO
    { LET FLT fy = FLOAT y
      LET r = ABS(3*x + 5*y) MOD 73
      LET g = ABS(53*x + 25*y) MOD 73
      LET b = ABS(103*x + 125*y) MOD 73
//sawritef("fx=%13.3f fy=%13.3f*n", fx, fy)
      setcolour(maprgb(30+r,30+g,30+b))
//writef("Calling gdrawquad3d*n")
      gdrawquad3d(fx,   fy,   Zro,
                  fx+20, fy,   Zro,
                  fx+20, fy+5, Zro,
                  fx,   fy+5, Zro)
      //updatescreen()
    }
  }
}

```

```

RETURN

```

```

    setcolour(col_white)
    ///draw_ground_point(      Zro,      Zro)
IF FALSE DO
  FOR x = 0 TO 3000 BY 100 DO
    { LET FLT fx = FLOAT x
      draw_ground_point(fx, -50.0)
      draw_ground_point(fx, +50.0)
    }
  // draw_ground_point(3000.0, Zro)

IF FALSE DO
  FOR k = 1000 TO 10000 BY 1000 DO
    { LET FLT fk = FLOAT k
      setcolour(col_lightmajenta)
      IF fk > 3000.0 DO draw_ground_point( k,  Zro)
      setcolour(col_white)
      draw_ground_point(-fk,  Zro)
      setcolour(col_red)
      draw_ground_point( Zro,  fk)
      setcolour(col_green)
      draw_ground_point( Zro, -fk)
    }
  }

AND seteyeposition() BE
{ cetn, cetw, ceth := One, Zro, Zro
  cewn, ceww, cewh := Zro, One, Zro
  celn, celw, celh := Zro, Zro, One

  IF FALSE DO
    { // Debugging eye orientation and distance
      cetn, cetw, ceth := One, Zro, Zro
      cewn, ceww, cewh := Zro, One, Zro
      celn, celw, celh := Zro, Zro, One
      eyedist := 30.0
      RETURN
    }
  }

UNLESS 0<=eyedir<=8 DO eyedir := 1

  IF hatdir & sdlmsecs(>)>hatmsecs+100 DO
    { eyedir := 0 //FIX((angle(ctn, ctw)+360.0+22.5) / 45.0) & 7
      // dir = 0 heading N

```

```

// dir = 1 heading NE
// dir = 2 heading E
// dir = 3 heading SE
// dir = 4 heading S
// dir = 5 heading SW
// dir = 6 heading W
// dir = 7 heading NW
SWITCHON hatdir INTO
{ DEFAULT:
  CASE #b0001:                                ENDCASE // Forward
  CASE #b0011: eyedir := eyedir+1; ENDCASE // Forward right
  CASE #b0010: eyedir := eyedir+2; ENDCASE // Right
  CASE #b0110: eyedir := eyedir+3; ENDCASE // Backward right
  CASE #b0100: eyedir := eyedir+4; ENDCASE // Backward
  CASE #b1100: eyedir := eyedir+5; ENDCASE // Backward left
  CASE #b1000: eyedir := eyedir+6; ENDCASE // Left
  CASE #b1001: eyedir := eyedir+7; ENDCASE // Forward left
}
eyedir := (eyedir & 7) + 1
hatdir := 0

//writef("ctn=%9.3f ctw=%9.3f eyedir=%9.1f*n", ctn, ctw, eyedir)
//abort(1009)
}

SWITCHON eyedir INTO
{ DEFAULT:

  CASE 0: // Pilot's view
    cetn, cetw, ceth := ctn, ctw, cth
    cewn, ceww, cewh := cwn, cww, cwh
    celn, celw, celh := cln, clw, clh
    RETURN

  CASE 1: // Looking North
    cetn, cetw, ceth := One, Zro, Zro
    cewn, ceww, cewh := Zro, One, Zro
    ENDCASE

  CASE 2: // North east
    cetn, cetw, ceth := D45, D45, Zro
    cewn, ceww, cewh := -D45, D45, Zro
    ENDCASE

  CASE 3: // East

```

```

    cetn, cetw, ceth := Zro, One, Zro
    cewn, ceww, cewh := -One, Zro, Zro
    ENDCASE

CASE 4: // South east
    cetn, cetw, ceth := -D45, D45, Zro
    cewn, ceww, cewh := -D45,-D45, Zro
    ENDCASE

CASE 5: // South
    cetn, cetw, ceth := -One, Zro, Zro
    cewn, ceww, cewh := Zro, -One, Zro
    ENDCASE

CASE 6: // South west
    cetn, cetw, ceth := -D45,-D45, Zro
    cewn, ceww, cewh := D45,-D45, Zro
    ENDCASE

CASE 7: // West
    cetn, cetw, ceth := Zro,-One, Zro
    cewn, ceww, cewh := One, Zro, Zro
    ENDCASE

CASE 8: // North west
    cetn, cetw, ceth := D45,-D45, Zro
    cewn, ceww, cewh := D45, D45, Zro
    ENDCASE
}

// make the eye look slightly down
ceth := ceth - eyeheight
standardize(@cetn)
crossprod(@cetn, @cewn, @celn)
}

AND processevents() BE WHILE getevent() SWITCHON eventtype INTO
{ DEFAULT:
    LOOP

CASE sdle_keydown:
    SWITCHON capitalch(eventa2) INTO
    { DEFAULT: LOOP

        CASE 'Q': done := TRUE

```

```

        LOOP

CASE 'P': // Toggle stepping
    stepping := ~stepping
    LOOP

CASE 'G': // Toggle stepping
    geardown := ~geardown
    LOOP

CASE 'D': // Toggle stepping
    debugging := ~debugging
    LOOP

CASE 'U': // Adjust eye height
    TEST eventa2='u' THEN eyeheight := eyeheight - 0.1
        ELSE eyeheight := eyeheight + 0.1
    LOOP

CASE 'S': // Toggle engin started
    enginestarted := ~enginestarted
    LOOP

CASE 'N': // Reduce eye distance
    eyedist := eyedist*5 / 6
    IF eyedist<5.0 DO eyedist := 5.0
    seteyeposition()
    LOOP

CASE 'F': // Increase eye distance
    eyedist := eyedist * 6 / 5
    seteyeposition()
    LOOP

CASE 'Z': c_trimthrottle := c_trimthrottle - 0.02
    throttle := c_trimthrottle+c_throttle
    IF throttle < 0.0 DO throttle, c_trimthrottle := 0.0, -c_throttle
    LOOP

CASE 'X': c_trimthrottle := c_trimthrottle + 0.02
    throttle := c_trimthrottle+c_throttle
    IF throttle > 1.0 DO throttle, c_trimthrottle := 1.0, 1.0-c_throttle
    LOOP

CASE ',':

```

```

CASE '<': c_trimrudder := c_trimrudder - 0.050
         rudder := c_trimrudder+c_rudder
         IF rudder < -1.0 DO rudder, c_trimrudder := -1.0, -1.0-c_rudder
//writef("Trim rudder left %6.3f*n", rudder)
         LOOP

CASE '.'':
CASE '>': c_trimrudder := c_trimrudder + 0.050
         rudder := c_trimrudder+c_rudder
         IF rudder > 1.0 DO rudder, c_trimrudder := 1.0, 1.0-c_rudder
//writef("Trim rudder right %6.3f*n", rudder)
         LOOP

CASE '0': eyedir, hatdir := 0, 0;          LOOP // Pilot's view
CASE '1': hatdir, hatmsecs := #b0001, 0; LOOP // From behind
CASE '2': hatdir, hatmsecs := #b0011, 0; LOOP // From behind right
CASE '3': hatdir, hatmsecs := #b0010, 0; LOOP // From right
CASE '4': hatdir, hatmsecs := #b0110, 0; LOOP // From in front right
CASE '5': hatdir, hatmsecs := #b0100, 0; LOOP // From in front
CASE '6': hatdir, hatmsecs := #b1100, 0; LOOP // From in front left
CASE '7': hatdir, hatmsecs := #b1000, 0; LOOP // From left
CASE '8': hatdir, hatmsecs := #b1001, 0; LOOP // From behind left

CASE 'T': initposition(1) // Set take off position
         LOOP

CASE 'A': initposition(2) // Set final approach position
         LOOP

CASE 'L': initposition(3) // Set level flight at 10000 ft.
         LOOP

CASE sdle_arrowup:
         c_trimelevator := c_trimelevator + 0.050
         elevator := c_trimelevator+c_elevator
         IF elevator > 1.0 DO elevator, c_trimelevator := 1.0, 1.0-c_elevator
         LOOP

CASE sdle_arrowdown:
         c_trimelevator := c_trimelevator - 0.050
         elevator := c_trimelevator+c_elevator
         IF elevator < -1.0 DO elevator, c_trimelevator := -1.0, -1.0-c_elevator
         LOOP

CASE sdle_arrowright:

```

```

        c_trimaileron := c_trimaileron + 0.050
        aileron := c_trimaileron+c_aileron
        IF aileron > 1.0 DO aileron, c_trimaileron := 1.0, 1.0-c_aileron
        LOOP

CASE sdle_arrowleft:
        c_trimaileron := c_trimaileron - 0.050
        aileron := c_trimaileron+c_aileron
        IF aileron < -1.0 DO aileron, c_trimaileron := -1.0, -1.0-c_aileron
        LOOP
}

CASE sdle_joyaxismotion: // 7
{ // This currently assumes that the joystick
  // is a CyborgX.
  LET which = eventa1
  LET axis = eventa2
  LET FLT value = (FLOAT eventa3) / 32768.0
//writef("axismotion: which=%n axis=%n value=%8.6f*n", which, axis, value)
  SWITCHON axis INTO
  { DEFAULT: LOOP
    CASE 0: c_aileron := value; // Aileron
            aileron := c_trimaileron+c_aileron
            IF aileron < -1.0 DO aileron, c_trimaileron := -1.0, -1.0-c_aileron
            IF aileron > 1.0 DO aileron, c_trimaileron := 1.0, 1.0-c_aileron
            LOOP
    CASE 1: c_elevator := -value; // Elevator
            elevator := c_trimelevator+c_elevator
            IF elevator < -1.0 DO elevator, c_trimelevator := -1.0, -1.0-c_elevator
            IF elevator > 1.0 DO elevator, c_trimelevator := 1.0, 1.0-c_elevator
            LOOP
    CASE 2: c_throttle := (1.0-value)/2.0; // Throttle
            throttle := c_trimthrottle+c_throttle
            IF throttle < 0.0 DO throttle, c_trimthrottle := 0.0, -c_throttle
            IF throttle > 1.0 DO throttle, c_trimthrottle := 1.0, 1.0-c_throttle
            LOOP
    CASE 3: c_rudder := value; // Rudder
            rudder := c_trimrudder+c_rudder
            IF rudder < -1.0 DO rudder, c_trimrudder := -1.0, -1.0-c_rudder
            IF rudder > 1.0 DO rudder, c_trimrudder := 1.0, 1.0-c_rudder
            LOOP
    CASE 4: LOOP // Right throttle
  }
}
}

```



```

CASE sdle_joyhatmotion:
{ LET which = eventa1
  LET axis = eventa2
  LET value = eventa3

  //writef("joyhatmotion %n %n %n*n", eventa1, eventa2, eventa3)

  SWITCHON value INTO
  { DEFAULT:
    CASE #b0000: // None
    CASE #b0001: // North
    CASE #b0011: // North east
    CASE #b0010: // East
    CASE #b0110: // South east
    CASE #b0100: // South
    CASE #b1100: // South west
    CASE #b1000: // West
    CASE #b1001: // North west
      IF value>hatdir DO
        { hatdir, hatmsecs := value, sdlmsecs()
//writef("hatdir=%b4 %n msecs*n", hatdir, hatmsecs)
        }
        LOOP
      }
  }
}

CASE sdle_joybuttondown: // 10
//writef("joybuttondown %n %n %n*n", eventa1, eventa2, eventa3)
SWITCHON eventa2 INTO
{ DEFAULT: LOOP
  CASE 7: // Left rudder trim
    c_trimrudder := c_trimrudder - 0.050
    rudder := c_trimrudder+c_rudder
    IF rudder < -1.0 DO rudder, c_trimrudder := -1.0, -1.0-c_rudder
    LOOP

  CASE 8: // Right rudder trim
    c_trimrudder := c_trimrudder + 0.050
    rudder := c_trimrudder+c_rudder
    IF rudder > 1.0 DO rudder, c_trimrudder := 1.0, 1.0-c_rudder
    LOOP

  CASE 11: // Reduce eye distance
    eyedist := eyedist*5/6
    IF eyedist < 60.0 DO eyedist := 60.0

```

```

//writef("eyedist=%9.3f*n", eyedist)
    LOOP
    CASE 12:    // Increase eye distance
        eyedist := eyedist*6/5
        IF eyedist > 1000.0 DO eyedist := 1000.0
//writef("eyedist=%9.3f*n", eyedist)
    LOOP
    CASE 13:    // Set pilot view
        eyedir, hatdir := 0, 0;                LOOP
}
LOOP

CASE sdle_joybuttonup:    // 11
//writef("joybuttonup*n", eventa1, eventa2, eventa3)
LOOP

CASE sdle_quit:          // 12
writef("QUIT*n");
LOOP

CASE sdle_videoresize:   // 14
//writef("videoresize*n", eventa1, eventa2, eventa3)
LOOP
}

AND initposition(n) BE SWITCHON n INTO
{ DEFAULT:

CASE 1: // Take off position
    cgn,    cgw,    cgh    := 100.0,    0,    3.0
    cgndot, cgwdot, cghdot := 10.0,    Zro, -0.1
    tdot,   wdot,   ldot   := cgndot,  0.0,  0.0

// The aircraft orientation -- level due north
ctn, ctw, cth := One, Zro, -0.001 // Direction cosines of aircraft
cwn, cww, cwh := Zro, One,    Zro
cln, clw, clh := 0.001, Zro,    One

stepping := TRUE
crashed := FALSE
enginestarted, rpm := FALSE, 0.0
targetrpm := rpm
thrust := 0.0
RETURN

```

```

CASE 2: // Position on the glide slope -- level due north
  cgn,   cgw,   cgh   := -4000.0, Zro,  1000.0   // Height of 1000 ft
  cgndot, cgwdot, cghdot :=   95.0, Zro,   Zro
  tdot,   wdot,   ldot :=  cgndot, 0.0,   0.0

  // The aircraft orientation
  ctn, ctw, cth := One, Zro, Zro // Direction cosines with
  cwn, cww, cwh := Zro, One, Zro // six decimal digits
  cln, clw, clh := Zro, Zro, One // after to decimal point.

  tdot, wdot, ldot := 95.0, 0.0, 0.0

  stepping := TRUE
  crashed := FALSE
  throttle := 0.5
  enginestarted, targetrpm := TRUE, 1600.0
  rpm := targetrpm
  thrust := 0.0
  RETURN

CASE 3: // Set flying level at 10000 ft at 65mph -- level due north
  cgn,   cgw,   cgh   := -20000.0, Zro, 10000.0 // Height of 10000 ft
  cgndot, cgwdot, cghdot :=   95.0, Zro,   Zro // 65mph = 95 ft/s
  tdot,   wdot,   ldot :=  cgndot, 0.0,   0.0

  // The aircraft orientation
  ctn, ctw, cth := One, Zro, Zro // Direction cosines of aircraft.
  cwn, cww, cwh := Zro, One, Zro
  cln, clw, clh := Zro, Zro, One

  //{ ctn, ctw, cth := One, Zro, Zro // Debugging values
  // cwn, cww, cwh := Zro, One, Zro
  // cln, clw, clh := Zro, Zro, One
  //}

  stepping := TRUE
  crashed := FALSE
  throttle := 0.5
  enginestarted, rpm := TRUE, 1900.0
  targetrpm := rpm
  thrust := 0.0
  RETURN
}

LET start() = VALOF

```

```

{ LET v = VEC 2
  datstamp(v)
  msecsl := v!1
  One := 1.0
  Zro := 0.0
  stepcount := 0
  steprate := 5.0
  crashed := FALSE
  geardown := TRUE
  debugging := TRUE
  enginestarted := FALSE

  c_throttle, c_elevator, c_aileron, c_rudder := Zro, Zro, Zro, Zro
  c_trimthrottle, c_trimelevator, c_trimaileron, c_trimrudder := Zro, Zro, Zro, Zro
  throttle, elevator, aileron, rudder := Zro, Zro, Zro, Zro

  //initposition(1) // Get ready for take off
  initposition(3) // Set flying level at 10000 ft at 65mph

  cetn, cetw, ceth := ctn, ctw, cth
  cewn, ceww, cewh := cwn, cww, cwh
  celn, celw, celh := cln, clw, clh

  hatdir, hatmsecs := #b0001, 0 // From behind
  eyedir := 1
  eyedist := 30.0 // Distance from the eye to the aircraft.
  eyeheight := 0.2 // Eye height above cgh
  seteyeposition()

  cockpitl := 6.0 // Cockpit 8 feet above the ground

  ft, fw, fl := Zro, Zro, Zro

  usage := 0

  initsdl()
  mkscreen("SDL Aircraft", 800, 500)

  fscreenxsize, fscreenysize := FLOAT screenxsize, FLOAT screenysize

  // Declare a few colours in the pixel format of the screen
  col_black := maprgb( 0, 0, 0)
  col_blue := maprgb( 0, 0, 255)
  col_green := maprgb( 0, 255, 0)

```

```

col_yellow      := maprgb( 0, 255, 255)
col_red         := maprgb(255,  0,  0)
col_magenta    := maprgb(255,  0, 255)
col_cyan       := maprgb(255, 255,  0)
col_white      := maprgb(255, 255, 255)
col_darkgray   := maprgb( 64,  64,  64)
col_darkblue   := maprgb(  0,  0,  64)
col_darkgreen  := maprgb(  0,  64,  0)
col_darkyellow := maprgb(  0,  64,  64)
col_darkred    := maprgb( 64,  0,  0)
col_darkmagenta := maprgb( 64,  0,  64)
col_darkcyan   := maprgb( 64,  64,  0)
col_gray       := maprgb(128, 128, 128)
col_lightblue  := maprgb(128, 128, 255)
col_lightgreen := maprgb(128, 255, 128)
col_lightyellow := maprgb(128, 255, 255)
col_lightred   := maprgb(255, 128, 128)
col_lightmagenta := maprgb(255, 128, 255)
col_lightcyan  := maprgb(255, 255, 128)

done := FALSE

UNTIL done DO
{ // Read joystick and keyboard events
  LET t0 = sdlmsecs()
  LET t1 = ?

  processevents()
  IF stepping UNLESS crashed DO step()
  plotscreen()
  drawcontrols()
  updatescreen()

  stepcount := stepcount + 1
  IF stepcount MOD 20 = 0 DO
  { LET prevmsecs = msecsl
    LET v = VEC 2
    LET s = VEC 15
    datstamp(v)
    msecsl := v!1
    datstring(s)
    steprate := 20 * 1000 / FLOAT(msecsl - prevmsecs)
    //sawritef("stepcount=%n msecsl diff=%i5 steprate = %6.3f %s*n",
    //          stepcount, msecsl-prevmsecs, steprate, s+5)
  }
}

```

```

    t1 := sdlmsecs()
//writef("time %9.3d %9.3d %9.3d %9.3d*n", t0, t1, t1-t0, t0+100-t1)
    usage := 100*(t1-t0)/100

    ///IF t0+100 < t1 DO sdlldelay(t0+100-t1)
    //sdlldelay(100)
    sdlldelay(20)
//abort(1120)
}

writef("*nQuitting*n")
sdlldelay(0_100)
closesdl()
RESULTIS 0
}

AND drawcontrols() BE
{ LET mx = screenxsize/2
  LET my = screenysize - 70 //- 100

  seteyeposition()

  setcolour(col_lightcyan)

  drawstring(240, 50, done -> "Quitting", "Simple Flight Simulator")

  setcolour(col_lightgray) // Draw runway line
  moveto(mx-1, my)
  drawby(0, FIX(3000.0/100.0))
  moveto(mx, my)
  drawby(0, FIX(3000.0/100.0))
  moveto(mx+1, my)
  drawby(0, FIX(3000.0/100.0))

  { LET dx = FIX(ctn*20) // Orientation of the aircraft
    LET dy = FIX(ctw*20)
    LET sdx = dx / 10 // Ground speed of the aircraft
    LET sdy = dy / 10
    LET x = mx-FIX(cgw/100)
    LET y = my+FIX(cgn/100)
    LET tx = x+5*dy/8
    LET ty = y-5*dx/8
    setcolour(col_red) // Draw aircraft symbol
    moveto(x-dy/4, y+dx/4) // Fuselage
  }
}

```

```

    drawby(+dy, -dx)
    moveto( x-dx/2, y-dy/2) // Wings
    drawby(+dx, +dy)
    moveto(tx, ty)          // Tail
    moveby(dx/4, dy/4)
    drawby(-dx/2, -dy/2)
}

// Draw the controls
setcolour(col_darkgray)
drawfillrect(screenxsize-20-100, screenysize-20-100, // Joystick
             screenxsize-20,      screenysize-20)
drawfillrect(screenxsize-50-100, screenysize-20-100, // Throttle
             screenxsize-30-100, screenysize-20)
drawfillrect(screenxsize-20-100, screenysize-50-100, // Rudder
             screenxsize-20,      screenysize-30-100)

IF crashed DO
{ setcolour(col_red)
  plotf(mx-50, my+50, "CRASHED")
}

{ LET pos = FIX(80 * throttle)
  setcolour(col_red)
  drawfillrect(screenxsize-45-100, pos+screenysize-15-100,
              screenxsize-35-100, pos+screenysize- 5-100)
}

{ LET pos = FIX(45 * rudder)
  setcolour(col_red)
  drawfillrect(pos+screenxsize-25-50, -5+screenysize-40-100,
              pos+screenxsize-15-50, +5+screenysize-40-100)
}

{ LET posx = FIX(45 * aileron)
  LET posy = FIX(45 * elevator)
  setcolour(col_red)
  drawfillrect(posx+screenxsize-25-50, posy+screenysize-25-50,
              posx+screenxsize-15-50, posy+screenysize-15-50)
}

setcolour(col_white)

IF debugging DO
{

```

```

plotf(20, my+15, "rpm=%i4", FIX rpm)
plotf(20, my, "Throttle=%6.3f Elevator=%6.3f Aileron=%6.3f Rudder=%6.3f",
        throttle, elevator, aileron, rudder)
plotf(20, my- 15, "cgn= %13.3f cgw= %13.3f cgh= %13.3f", cgn, cgw, cgh)
plotf(20, my- 30, "cgndot= %13.3f cgwdot=%13.3f cghdot=%13.3f", cgndot, cgwdot, cghdot)
plotf(20, my- 45, "tdot= %13.3f wdot= %13.3f ldot= %13.3f", tdot, wdot, ldot)
plotf(20, my- 60, "ctn= %7.3f ctw= %7.3f cth= %7.3f", ctn, ctw, cth)
plotf(20, my- 75, "cwn= %7.3f cww= %7.3f cwh= %7.3f", cwn, cww, cwh)
plotf(20, my- 90, "cln= %7.3f clw= %7.3f clh= %7.3f", cln, clw, clh)
plotf(20, my-105, "ft= %13.3f fw= %13.3f fl= %13.3f", ft, fw, fl)
plotf(20, my-150, "steprate=%8.3f", steprate)

plotf(20, my-200, "cetn= %7.3f cewn= %7.3f celn= %7.3f", cetn, cewn, celn)
plotf(20, my-215, "cetw= %7.3f ceww= %7.3f celw= %7.3f", cetw, ceww, celw)
plotf(20, my-230, "ceth= %7.3f cewh= %7.3f celh= %7.3f", ceth, cewh, celh)

plotf(20, my-260, "eyedist= %7.3f", eyedist)

}

{ LET heading = - FIX (angle(ctn,ctw))
  IF heading < 0 DO heading := 360 + heading
  plotf(20, 5, "RPM %4i Thrust %4i Speed %3i mph Altiude %i5 ft Heading %i3 Usage %3i%",
//      FIX rpm, FIX thrust, FIX (tdot*fps2mph), FIX cgh, heading, usage)
//      FIX rpm, FIX thrust, FIX (fps2mph*tdot), FIX cgh, heading, usage)
  }
//updatescreen()
}

```

The following sections require major revision

As can be seen this inserts the BCPL source of the SDL library and then declares the global variables used in the program.

The variable `done` is set to `TRUE` when `Q` is pressed causing the program to terminate. The variable `object` specified which of four possible objects is to be drawn. The default value selects a representation of a tiger moth aircraft.

The variable `stepping` can be set to `FALSE` by pressing `P` to temporarily stop the displayed image being rotated.

As stated above the orientation of the displayed object is specified by direction cosines held in the variables such as `ctx`, `cty` and `ctz`. Direction cosines have a remarkable and particularly useful property which is as follows. Suppose P and Q are two points on the unit sphere with coordinates (x, y, z) and (X, Y, Z) , respectively, the expression $xX + yY + zZ$ is called the *inner product* of (x, y, z) and (X, Y, Z) and is often written as $(x, y, z).(X, Y, Z)$. It turns out that its value is the cosine of the angle between the lines OP and OQ .

We can convince ourselves that this by the following observation. If we rotate P and Q about the \mathbf{z} -axis by some arbitrary angle α , they move to new positions P' and Q' with coordinates $(x \cos \alpha - y \sin \alpha, x \sin \alpha + y \cos \alpha, z)$ and $(X \cos \alpha - Y \sin \alpha, X \sin \alpha + Y \cos \alpha, Z)$. It is clear that the angle between OP' and OQ' is the same that between OP and OQ . We can see that this rotation did not change the inner product, since

$$\begin{aligned} & (x \cos \alpha - y \sin \alpha, x \sin \alpha + y \cos \alpha, z) \cdot (X \cos \alpha - Y \sin \alpha, X \sin \alpha + Y \cos \alpha, Z) = \\ & (x \cos \alpha - y \sin \alpha)(X \cos \alpha - Y \sin \alpha) + \\ & (x \sin \alpha + y \cos \alpha)(X \sin \alpha + Y \cos \alpha) + zZ = \\ & xX \cos^2 \alpha - xY \cos \alpha \sin \alpha - yX \sin \alpha \cos \alpha + yY \sin^2 \alpha + \\ & xX \sin^2 \alpha + xY \sin \alpha \cos \alpha + yX \cos \alpha \sin \alpha + yY \cos^2 \alpha + zZ = \\ & xX(\cos^2 \alpha + \sin^2 \alpha) + yY(\cos^2 \alpha + \sin^2 \alpha) + zZ = \\ & xX + yY + zZ \end{aligned}$$

So, if we take an arbitrary pair of points P and Q on the unit sphere and rotate them about the \mathbf{z} axis until Q is in the \mathbf{xz} plane, then rotate them about the \mathbf{y} -axis until Q is on the \mathbf{x} -axis and finally rotate them about the \mathbf{x} -axis until P is in the \mathbf{xy} plane. Assuming the angle between the original OP and OQ was θ , the angle between their new positions will still be θ and so the new coordinates of P and Q will be $(\cos \theta, \sin \theta, 0)$ and $(1, 0, 0)$, and their inner product will be $\cos \theta \times 1 + \sin \theta \times 0 + 0 \times 0 = \cos \theta$. This confirms that the inner product of two sets of direction cosines is the cosine of the angle between the two directions they specify.

The BCPL function to calculate the inner product is defined as follows.

If we write the distance from O to (x, y, z) as $(1 + \epsilon)$, the call `inprod(x,y,z, x,y,z)` yields the square of this length, namely $(1 + \epsilon)^2$ which equals $(1 + 2\epsilon + \epsilon^2)$. Provided ϵ is small this is approximately $(1 + 2\epsilon)$ and so an estimate of ϵ is $(\text{inprod}(x,y,z, x,y,z) - \text{One})/2$. The length correction requires us to divide \mathbf{x} by $(1 + \epsilon)$ which is exactly what `v!0 := muldiv(x, One, corr)` does since `corr` is set to $(1 + \epsilon)$. The corrections to \mathbf{y} and \mathbf{z} are done in the same way.

The number of times `step` is called per second is held in `Sps`. So on each call the angle of rotation about the \mathbf{t} -axis is `rtdot/Sps`. The rotational angles for the other two axes are calculated in the same way. Every time `step` is called the rotational rates are adjusted by rotational forces held in `rft`, `rftw` and `rfl`. These are in units of radians per second per second and are adjusted to suit the stepping rate. In a flight simulator these forces depend on the speed and direction of the airflow around the aircraft and the setting of the flying controls such as the elevator or rudder. In `draw3d.b` these controls can be modified using the

arrow keys and the characters '<' and '>'. The distance between the eye and the object can be modified by pressing 'F' and 'N'.

The program is controlled using the mouse and keyboard. These interactions are dealt with by `processevents` whose definition is as follows.

Events are read by calls of `getevent` which returns `TRUE` whenever another event is present. The type of event is placed in `eventtype`. If it is a key down event from the keyboard `eventtype=sdle_keydown` and `eventa2` identifies which key was pressed. The `SWITCHON` command has cases for each key that affects to program. The code for each is easy to follow. All other keys are ignored at the `DEFAULT` label. The only mouse event to be handled has type `sdle_quit` caused by clicking on the little cross at the top right hand corner of the window. As can be seen this sets `done` to `TRUE` causing the program to terminate.

Finally, there is the main program `start` which initialises the variables used by the program, creates a window entitled `Draw 3D Demo` and enters the main processing loop which repeatedly calls `processevents` to deal with keyboard and mouse events, before conditionally calling `step` to rotate the object, followed by calls `plotscreen` and `updatescreen` to draw the new state of the object and send it to the display hardware. It then issues a short delay before going round the loop again. It only leaves the loop when `done` becomes `TRUE`. This delays briefly before closing the SDL window and terminating the program. The definition of `start` is as follows.

This picture shows a Cyborg X USB joystick. It can control the aileron, elevator and rudder, and has two throttle levers which can be locked together. There is an eight direction hat buttons which can be used to change the direction of view of either the pilot or an observer, and there are 12 other buttons. It typically costs about £32.

More to follow.

This chapter has used the rather primitive SDL graphics library and has typically drawn everything pixel by pixel, even when drawing 3D images involving hidden surface removal. The result is quite slow but is educational since by looking at the BCPL graphics library (`sd1.h`, `sd1.b`) you can see how lines, circles and other shapes can be drawn. You can also see how hidden surface removal can be implemented. The disadvantage is that the library does not take advantage of the extraordinary power of the graphics hardware available on most modern machines. The next chapter presents a BCPL interface to the much more sophisticated OpenGL library that can take full advantage of the machine's graphics hardware. This give much improved performance and allows for much more realistic moving images.

Even without using OpenGL, you can considerably improve performance by using the native code implementation of BCPL. For instance, the `bucket` and `tiger` programs can be compiled and run by typing the following.

```
cd ../../natbcpl
make -f MakefileRaspiSDL clean
make -f MakefileRaspiSDL bucket
./bucket
./tiger
```

Chapter 6

Interactive Graphics in BCPL using OpenGL

This chapter and the software it describes is still under development but is at last beginning to work. It is possible that I will upgrade to SDL2, provided I can get it to work on the Raspberry Pi, since it has many advantages over the older SDL. In particular, it can interface with OpenGL ES. This upgrade will cause several changes in both this and the previous chapter.

A second major change is that I have at last decided, after 50 years, to add single length floating point operations to the standard BCPL distribution since these are useful when interacting with OpenGL. This is a fairly major change since it also requires an upgrade to the Sial system and the creation of sial-686.b and a major modification to sial-arm

OpenGL is a sophisticated library providing an efficient way of generating 3D graphical images using the full power of the graphics hardware available on most machines. Unfortunately this library comes in two forms. The full version, called OpenGL, is typically available on desktop and laptop computers while a cutdown version, called OpenGL ES, is typically available on smart phones and tablets where memory and computing power is more restricted. OpenGL ES is the version available on the Raspberry Pi.

Currently, OpenGL ES is often not available on the larger machines, so the BCPL GL library provides the same graphics facilities independent of which version of OpenGL is being used. OpenGL ES is mostly a subset of the features available in the full version of OpenGL. The BCPL GL library is designed to be easy to use and so only provides a subset of this subset.

Currently SDL can call OpenGL directly but not OpenGL ES. Although very simple, SDL provides a good interface with the keyboard, joysticks, the sound system and clocks. If SDL cannot be combined with OpenGL ES, other mechanisms (such as EGL) will be used to access these vital peripheral devices. Whichever version of OpenGL is used, the graphics features available to BCPL will be the same. To access these features the BCPL code will need to insert the

header files `cintcode/g/gl.h` and `cintcode/g/gl.b`. The low level OpenGL functions are available via `sys` calls as defined in `sysc/glfn.c`, but users will normally use the higher level BCPL functions defined in `g/gl.b`.

OpenGL makes extensive use of 32-bit floating point numbers but standard BCPL only provides limited floating point facilities via the `sys` interface. Where OpenGL requires floating point numbers, BCPL programs will normally use scaled fixed point values and have them converted to floating point by functions in the BCPL GL library.

6.1 Introduction to OpenGL

OpenGL is primarily designed to generate 2D images on the screen of 3D scenes composed of huge numbers of points, lines and triangles in three dimensions using the full power of the graphics hardware available on most computers. The graphics hardware is usually sufficiently powerful to display scenes involving hundreds of thousands of triangles with hidden surface removal and sophisticated lighting effects at a sufficient rate to provide smooth moving images.

OpenGL makes extensive use of vertices to represent points, ends of lines and the corners of triangles. Each vertex is specified by up to 8 *attributes* numbered from 0 to 7, each consisting of four components. Although OpenGL allows other data types, the BCPL interface insists that all attribute components are 32-bit floating point numbers. Attributes are used to represent the coordinates, colours and other properties of the vertices. The GL library provides facilities for defining vertices and transmitting them to the graphics hardware where they can be processed efficiently. Vertices are numbered from zero upwards. Points, lines and triangles can be specified using these vertex numbers. For scenes involving a huge number of triangles, it is usual to specify their vertex numbers in index arrays which can either be held in user memory, or, for greater efficiency, they can be transmitted to memory owned by the graphics hardware.

When the graphics hardware processes a triangle, it must first perform a calculation on each of its vertices to discover their pixel coordinates and other properties before it sets about the rasterisation process of calculating the position and colour of every pixel resulting from the triangle. The vertex computation is typically done by a user provided program called a *vertex shader* that runs on the graphics hardware. The BCPL GL library has a function to read a vertex shader program from file, compile it and transmit it to the graphics hardware. Each pixel generated during rasterisation involves the executions of another user provided program run on the graphics hardware called a *fragment shader*. As with vertex shaders, the BCPL GL library has a function to read a fragment shader program from file, compile it and transmit it to the graphics hardware. Vertex and fragment shaders use the same simple programming language that will be described later.

Vertex shaders can access the attributes of the vertex it is processing, and can also access global quantities, called *uniforms*, which are available for all vertices. Uniform variables typically contain data about the rotation and position of objects in the scene being displayed as well as information about how it is being viewed. This might, for instance, be the position and orientation of a camera that is viewing the scene. Every time the graphics hardware generates a new screen image the position and rotations of objects in the scene may change as well as the position and orientation of the camera. Provided the graphics hardware is efficient enough, the whole scene should seem to move smoothly.

The output of vertex shaders are passed to the fragment shader via, so called, *varying variables*. The vertex shader will calculate the value of each varying variable at the position of its vertex, but if a line or triangle is being drawn, the value received by the fragment shader for each pixel will be a linear interpolation of the corresponding varying variables of the vertices that define the line or triangle. So, for instance, the colour can change smoothly over the surface of a displayed triangle. The graphics hardware will perform this interpolation efficiently. Fragment shaders can also access uniform variables. Such data can, for instance, be used to control lighting effects.

In addition to the x-y screen coordinates of the apparent position of a vertex, the vertex shader often calculates the depth into the screen of its position. This value can be used to eliminate pixels that are hidden behind surfaces that are closer to the camera. Again, the graphics hardware can perform this hidden surface removal efficiently.

The shader language allows users to give names to attribute variables using declarations such as `attribute vec3 a_position` and `attribute vec4 a_colour`. Since the position and colour of vertices can be set up by the user, it is necessary to know which attribute locations are being used for these quantities. The BCPL GL library provides the function `glGetAttribLocation(...)` to find out where attributes were located after the shaders have been compiled and linked. An alternative mechanism in which the user chooses these locations before linking is available but is not recommended.

6.2 Geometric Transformations

Before giving an example program that uses OpenGL, we need to understand some of the mathematics involved in rotating a model in three dimensions and observing it from an eye position that can be moved.

We saw on page 336 that two dimensional rotations can be performed by multiplying the coordinates by a 2 by 2 matrix. It should be of little surprise to find the rotations in three dimensions can be performed using 3 by 3 matrices, however using 4 by 4 matrices turns out to be even better since it allows for other useful transformations to be performed in addition to simple rotations. OpenGL and

graphics hardware provide efficient implementations of 4 by 4 matrix operations so we will use these for most of the geometric transformations we need.

When 4 by 4 matrices are multiplied together and the rule is as follows.

$$\begin{pmatrix} \cdot & \cdot & \cdot & \cdot \\ \cdot & \cdot & \cdot & \cdot \\ a & b & c & d \\ \cdot & \cdot & \cdot & \cdot \end{pmatrix} \begin{pmatrix} \cdot & x & \cdot & \cdot \\ \cdot & y & \cdot & \cdot \\ \cdot & z & \cdot & \cdot \\ \cdot & w & \cdot & \cdot \end{pmatrix} = \begin{pmatrix} \cdot & \cdot & \cdot & \cdot \\ \cdot & \cdot & \cdot & \cdot \\ \cdot & t & \cdot & \cdot \\ \cdot & \cdot & \cdot & \cdot \end{pmatrix}$$

where $t = ax + by + cz + dw$, that is the value in the i^{th} row and j^{th} column of the result is the sum of the products of the elements of the i^{th} row of the left hand matrix with the corresponding elements of the j^{th} column of the right hand one. The matrices do not have to be square, all that is required is that the number of columns of the left hand matrix must equal the number of rows of the right hand one.

If **A**, **B** and **C** are three 4 by 4 matrices then $(\mathbf{AB})\mathbf{C}=\mathbf{A}(\mathbf{BC})$. This can be seen by considering the product:

$$\begin{pmatrix} a_{00} & a_{01} & a_{02} & a_{03} \\ a_{10} & a_{11} & a_{12} & a_{13} \\ a_{20} & a_{21} & a_{22} & a_{23} \\ a_{30} & a_{31} & a_{32} & a_{33} \end{pmatrix} \begin{pmatrix} b_{00} & b_{01} & b_{02} & b_{03} \\ b_{10} & b_{11} & b_{12} & b_{13} \\ b_{20} & b_{21} & b_{22} & b_{23} \\ b_{30} & b_{31} & b_{32} & b_{33} \end{pmatrix} \begin{pmatrix} c_{00} & c_{01} & c_{02} & b_{03} \\ c_{10} & c_{11} & c_{12} & b_{13} \\ c_{20} & c_{21} & c_{22} & b_{23} \\ c_{30} & c_{31} & c_{32} & b_{33} \end{pmatrix}$$

It is fairly easy to see that the value in the i^{th} row and j^{th} column of the result is the sum of 16 terms of the form $a_{ip}b_{pq}c_{qj}$ with p and q taking all values between 0 and 3 and this is independent of whether the left hand or right hand pair of matrices are multiplied first. This is analogous to the rule in ordinary arithmetic that, for instance, $(10 \times 11) \times 12 = 10 \times (11 \times 12)$. But note that with matrix multiplication \mathbf{AB} is typically not equal to \mathbf{BA} , just as rotating an object about the X-axis and then the Y-axis is usually different from first rotating about the Y-axis and then the X-axis.

To gain some feeling for what 4 by 4 matrix multiplication can do we will look at a few special cases. But first we should see how the four coordinates (x, y, z, w) are used to represent a point in three dimensions. The conventional approach is to regard them as, so called, *homogenous* coordinates in which only the ratios between them are significant. So, if all four coordinates are multiplied by the same constant, the result still represents the same point. By convention (x, y, z, w) represents the point whose three dimensional coordinates are $(x/w, y/w, z/w)$. We will often use $(x, y, z, 1)$ to represent a point with coordinates (x, y, z) .

The first special case is as follows.

$$\begin{pmatrix} 1 & 0 & 0 & 0 \\ 0 & 1 & 0 & 0 \\ 0 & 0 & 1 & 0 \\ 0 & 0 & 0 & 1 \end{pmatrix} \begin{pmatrix} a & b & c & d \\ e & f & g & h \\ i & j & k & l \\ m & n & o & p \end{pmatrix} = \begin{pmatrix} a & b & c & d \\ e & f & g & h \\ i & j & k & l \\ m & n & o & p \end{pmatrix}$$

Since this matrix leaves its operand unchanged it is called the identity matrix. Another special case is the following.

$$\begin{pmatrix} 1 & 0 & 0 & X \\ 0 & 1 & 0 & Y \\ 0 & 0 & 1 & Z \\ 0 & 0 & 0 & 1 \end{pmatrix} \begin{pmatrix} x \\ y \\ z \\ 1 \end{pmatrix} = \begin{pmatrix} x + X \\ y + Y \\ z + Z \\ 1 \end{pmatrix}$$

This is called a translation matrix since it moves every point of a model by the same amount in three dimensions without rotation. The following matrix will rotate every vertex of the model about the Z-axis by an angle θ .

$$\begin{pmatrix} \cos \theta & -\sin \theta & 0 & 0 \\ \sin \theta & \cos \theta & 0 & 0 \\ 0 & 0 & 1 & 0 \\ 0 & 0 & 0 & 1 \end{pmatrix} \begin{pmatrix} x \\ y \\ z \\ 1 \end{pmatrix} = \begin{pmatrix} x \cos \theta - y \sin \theta \\ x \sin \theta + y \cos \theta \\ z \\ 1 \end{pmatrix}$$

You can see this since it leaves z and w unchanged while replacing x and y by $x \cos \theta - y \sin \theta$ and $x \sin \theta + y \cos \theta$, respectively, which corresponds to a clockwise rotation of angle θ when viewing along the z-axis from the origin.

There are two other similar matrices for rotations about the X and Y axes, namely:

$$\begin{pmatrix} 1 & 0 & 0 & 0 \\ 0 & \cos \theta & -\sin \theta & 0 \\ 0 & \sin \theta & \cos \theta & 0 \\ 0 & 0 & 0 & 1 \end{pmatrix} \begin{pmatrix} x \\ y \\ z \\ 1 \end{pmatrix} = \begin{pmatrix} x \\ y \cos \theta - z \sin \theta \\ y \sin \theta + z \cos \theta \\ 1 \end{pmatrix}$$

and

$$\begin{pmatrix} \cos \theta & 0 & \sin \theta & 0 \\ 0 & 1 & 0 & 0 \\ -\sin \theta & 0 & \cos \theta & 0 \\ 0 & 0 & 0 & 1 \end{pmatrix} \begin{pmatrix} x \\ y \\ z \\ 1 \end{pmatrix} = \begin{pmatrix} x \cos \theta + z \sin \theta \\ y \\ -x \sin \theta + z \cos \theta \\ 1 \end{pmatrix}$$

If (a, b, c) , (d, e, f) and (g, h, i) are direction cosines, they will correspond to three mutually orthogonal points on the unit sphere centred at the origin. The following matrix will then rotate the model coordinates $(1, 0, 0, 1)$, $(0, 1, 0, 1)$ and $(0, 0, 1, 1)$ to $(a, b, c, 1)$, $(d, e, f, 1)$ and $(g, h, i, 1)$.

$$\begin{pmatrix} a & d & g & 0 \\ b & e & h & 0 \\ c & f & i & 0 \\ 0 & 0 & 0 & 1 \end{pmatrix}$$

Thus it will rotate the model about the origin, without deformation, to any desired orientation.

6.3 Viewing the Scene

Suppose we have a model specified by vertices with xyz coordinates near the origin (O) and we wish to view it from an eye position (P) whose coordinates are (a, b, c) as shown in the following diagram.

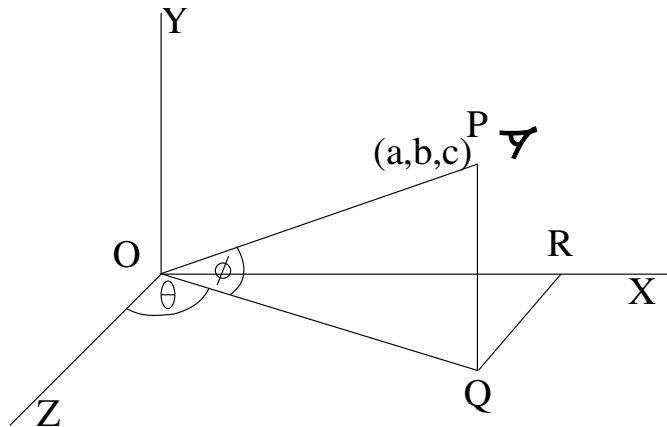

A good strategy is to think of the eye as rigidly attached to the model and perform two rotations of both the model and the eye. The first is an anticlockwise rotation (**R1**) of θ degrees about the Y-axis to bring the eye position into the YZ plane. The second rotation (**R2**) is of ϕ degrees clockwise about the X-axis to bring the eye position onto the Z-axis. Since the eye is rigidly connected to the model, its shape, as seen from the eye, will not have changed, however the XY plane will now be parallel to the display screen, so the x and y coordinates will respectively represent horizontal and vertical displacements on the screen, and z will be a measure of the depth of the vertex into the screen. Notice that we do not need to calculate the angles θ and ϕ since we only need their cosines and sines. These are as follows:

$$\begin{aligned}\cos \theta &= \frac{RQ}{OQ} = \frac{c}{\sqrt{a^2+c^2}} \\ \sin \theta &= \frac{RQ}{OQ} = \frac{a}{\sqrt{a^2+c^2}} \\ \cos \phi &= \frac{OQ}{OP} = \frac{\sqrt{a^2+c^2}}{\sqrt{a^2+b^2+c^2}} \\ \sin \phi &= \frac{QP}{OP} = \frac{b}{\sqrt{a^2+b^2+c^2}}\end{aligned}$$

We can thus easily construct the matrices for the two rotations **R1** and **R2** that will move the eye position from P to a point on the Z axis. These can be multiplied together to give a single matrix to perform both rotations. Care is needed since the first rotation is anti-clockwise about the Y axis while the second is clockwise about the X axis. After these two rotations the eye position will be on the z axis at the same distance from the origin as it was before the rotations. However, it is sometimes convenient to change the distance between the eye and the centre of the model to, say, d units. We can do this and change the origin to the eye position by multiplying by the matrix:

$$\begin{pmatrix} 1 & 0 & 0 & 0 \\ 0 & 1 & 0 & 0 \\ 0 & 0 & 1 & -d \\ 0 & 0 & 0 & 1 \end{pmatrix}$$

Notice that this moves every vertex of the model in the negative z direction by a distance d .

The next transformation to apply calculates the perspective view in which distant features of the model look smaller than those that are close to the eye. The following diagram shows the YZ plane when viewed from the X direction.

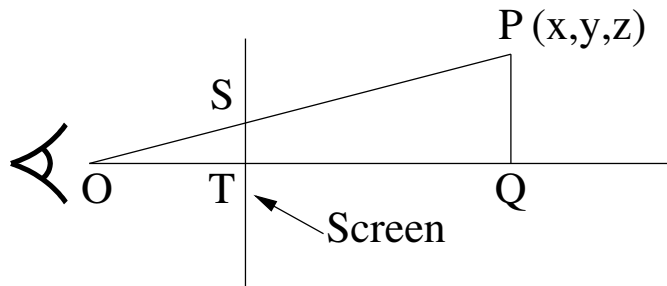

It is easy to see that the triangles OST and OPQ have the same shape (mathematically they are *similar*). This implies that

$$\frac{ST}{OT} = \frac{PQ}{OQ}$$

and so

$$ST = \frac{OT}{OQ} \times \frac{y}{z}$$

Thus the y position on the screen depends on the y value of the point divided by its z value and multiplied by a scaling factor. The important thing to note is that this projection requires a division by z but this cannot be done by matrix multiplication. However, all is not lost. The following diagram shows what is required.

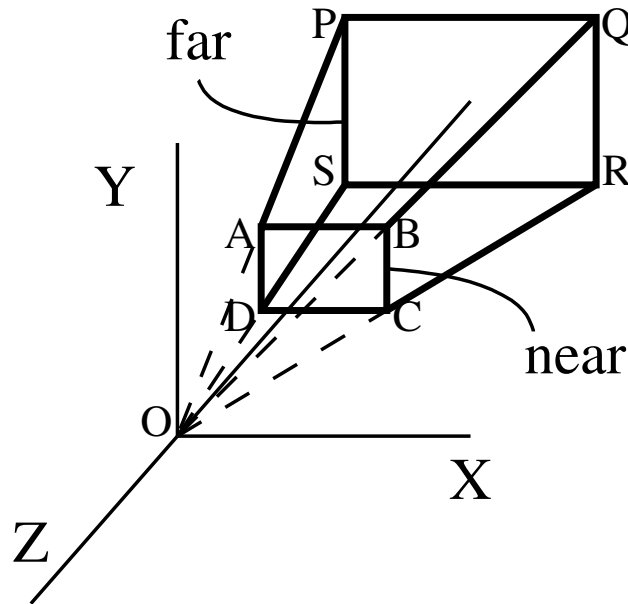

It shows a truncated pyramid with a face ($ABCD$) *near* the origin (where the eye is placed) and a more distant similar face ($PQRS$) labelled *far*. Parts of the scene that are behind the eye or too close will not be displayed, nor will parts that are too distant or out of the field of view. So only points inside the truncated pyramid contribute to the final image on the screen. All other parts of the scene are said to be *culled*.

The details of the truncated pyramid can be completely specified by n and f the distances from the origin of the near and far faces, and (l, b) and (r, t) the xy coordinates of D and B . Using these six values we can construct the following extraordinary 4 by 4 matrix.

$$\mathbf{P} = \begin{pmatrix} \frac{2n}{r-l} & 0 & \frac{r+l}{r-l} & 0 \\ 0 & \frac{2n}{t-b} & \frac{t+b}{t-b} & 0 \\ 0 & 0 & -\frac{f+n}{f-n} & -\frac{2nf}{f-n} \\ 0 & 0 & -1 & 0 \end{pmatrix}$$

The first thing to notice is that, once the six values n , f , l , r , b and t , are known, the matrix just contains 16 constant elements and so corresponds to a *linear* transformation, and linear transformations have the useful property that straight lines map into straight lines. It turns out that \mathbf{P} transforms the truncated pyramid into a cube whose x , y and z coordinates all range from -1 to +1.

We can see this by considering what happens to each of the 8 vertices of the truncated pyramid. But first observe what happens when \mathbf{P} is applied to a point with homogeneous coordinates $(x, y, z, 1)$.

$$\mathbf{P} \begin{pmatrix} x \\ y \\ z \\ 1 \end{pmatrix} = \begin{pmatrix} +\frac{2nx}{r-l} + \frac{(r+l)z}{r-l} \\ +\frac{2ny}{t-b} + \frac{(t+b)z}{t-b} \\ -\frac{2nf}{f-n} - \frac{(f+n)z}{f-n} \\ -z \end{pmatrix}$$

So the result represents a point with the following xyz coordinates.

$$\begin{pmatrix} -\frac{2nx}{(r-l)z} - \frac{r+l}{r-l} \\ -\frac{2ny}{(t-b)z} - \frac{t+b}{t-b} \\ +\frac{2nf}{(f-n)z} + \frac{f+n}{f-n} \end{pmatrix}$$

So when \mathbf{P} is applied to point A whose coordinates are $(l, t, -n)$ the result is:

$$\begin{pmatrix} +\frac{2nl}{(r-l)n} - \frac{r+l}{r-l} \\ +\frac{2nt}{(t-b)n} - \frac{t+b}{t-b} \\ -\frac{2nf}{(f-n)n} + \frac{f+n}{f-n} \end{pmatrix} = \begin{pmatrix} \frac{2l-r-l}{r-l} \\ \frac{2t-t-b}{t-b} \\ \frac{-2f+f+n}{f-n} \end{pmatrix} = \begin{pmatrix} -1 \\ +1 \\ -1 \end{pmatrix}$$

So $A(l, t, -n)$ maps to $(-1, +1, -1)$ and using similar algebra it is easy to see that the points $B(r, t, -n)$, $C(r, b, -n)$ and $D(l, b, -n)$ map into $(+1, +1, -1)$, $(+1, -1, -1)$ and $(-1, -1, -1)$, respectively.

Since OAP is a straight line, the coordinates of P are just those of A multiplied by a scaling factor of f/n . The coordinates of P are thus $(lf/n, tf/n, -f)$ and when we apply \mathbf{P} the result is:

$$\begin{pmatrix} +\frac{2nlf/n}{(r-l)f} - \frac{r+l}{r-l} \\ +\frac{2ntf/n}{(t-b)f} - \frac{t+b}{t-b} \\ -\frac{2nf}{(f-n)f} + \frac{f+n}{f-n} \end{pmatrix} = \begin{pmatrix} \frac{2l-r-l}{r-l} \\ \frac{2t-t-b}{t-b} \\ \frac{-2n+f+n}{f-n} \end{pmatrix} = \begin{pmatrix} -1 \\ +1 \\ +1 \end{pmatrix}$$

So $P(lf/n, tf/n, -f)$ maps to $(-1, +1, +1)$ and, using similar algebra, it is easy to see that the points $Q(rf/n, tf/n, -f)$, $R(rf/n, bf/n, -f)$ and $S(lf/n, bf/n, -f)$ map into $(+1, +1, +1)$, $(+1, -1, +1)$ and $(-1, -1, +1)$, respectively. Thus the eight vertices of the truncated pyramid map into the eight corners of a $2 \times 2 \times 2$ cube centred at the origin, and since the mapping is linear, the faces of the truncated pyramid map into the faces of the cube.

We can multiply all the transformation matrices described above to construct a single 4 by 4 matrix that will do the entire transformation. This can be transmitted to an OpenGL uniform variable where it can be used efficiently by the vertex shader for every vertex in the scene.

Finally, we can tell OpenGL the position, width and height of a rectangle on the screen to display the object. OpenGL will then efficiently transform the cube coordinates to screen coordinates using the z component to eliminate hidden surfaces.

6.4 A first OpenGL example

This example displays a rotating image containing a hollow coloured cube modified to look somewhat like a missile with control surfaces. The rate of rotation about the three axes can be controlled by pressing $<$, $>$ and the arrow keys. The eye looks toward the centre of the model in a direction controlled by 0, 1, 2, 3, 4, 5, 6 and 7. The eye distance is controlled by $+$ and $-$. The program can be compiled and run by typing the following two commands. You can toggle the stepping of the model by pressing S. The model can be moved forward, backwards, left, right, up and down by pressing F, B, L, R, U and D.

```
c b gltst
gltst -a
```

The following is a typical frame generated by this program.

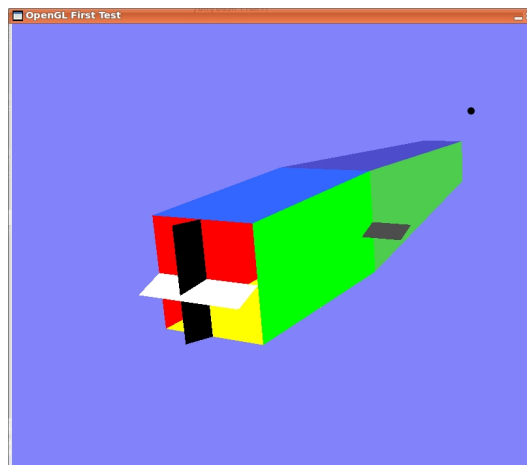

The vertex and index data will be copied to the graphics hardware where it will be processed efficiently. The source of the program is in `bcplprogs/raspi/gltst.b` and is as follows. Hopefully, the comments provide a sufficient description of how it works.

```
/*
```

```
This program is a simple demonstration of the OpenGL interface.
```

```
The BCPL GL library is in g/gl.b with header g/gl.h and is designed to
work unchanged with either OpenGL using SDL or OpenGL ES using EGL.
```

```
Implemented by Martin Richards (c) July 2014
```

```
History
```

```
03/05/18
```

```
Extensively modified to use floating point and the FLT feature.
```

```
23/03/15
```

```
Simplified this program to only display gltst.mdl with limited control.
```

```
20/12/14
```

```
Modified the cube to be like a square missile with control surfaces.
```

```
03/12/14
```

```
Began conversion to use floating point numbers.
```

```
Command argument:
```

```
-d      Turn on debugging
```

```
Controls:
```

```
Q  causes quit
```

```
P  Output debugging info to the terminal
```

```
S  Stop/start the stepping the image
```

```
Rotational controls
```

```
Right/left arrow Increase/decrease rotation rate about direction of thrust
```

```
Up/Down arrow   Increase/decrease rotation rate about direction of right wing
```

```
> <             Increase/decrease rotation rate about direction of lift
```

```
0,1,2,3,4,5,6,7 Set eye direction -- The eye is always looking
                    towards the origin.
```

+, - Increase/decrease eye distance

The transformations

The model is represented using three axes t (the direction of thrust), w the direction of the left wing and l (the direction of lift, orthogonal to t and w). These use the right hand convention, ie t is forward, w is left and l is up.

Real world coordinate use axes x (right), y(up) and z(towards the viewer). These also use the right hand convention.

```
ctx; cty; ctz // Direction cosines of direction t
cwx; cwz; cwz // Direction cosines of direction w
clx; cly; clz // Direction cosines of direction l
```

```
eyex, eyey, eyez specify a point on the line of sight
                    between the eye and the origin. The line of
                    sight is towards the origin from this point.
```

```
eyedistance holds the distance between the eye and the origin.
```

Since standard BCPL now supports floating point operations and the latest Raspberry Pi (Model B-2 and later) has proper support for floating point this program now uses floating point and the FLT feature.

```
*/
```

```
GET "libhdr"
GET "gl.h"
GET "gl.b" // Insert the library source code
```

```
.
GET "libhdr"
GET "gl.h"
```

```
GLOBAL {
  done:ug
  stepping
  debug
  glprog
  Vshader
  Fshader
```

```
VertexLoc // Attribute variable locations
ColorLoc
```

```

DataLoc    // data[0]=ctrl  data[1]=value

MatrixLoc  // Uniform variable locations
ControlLoc

FLT CosElevator
FLT SinElevator
FLT CosRudder
FLT SinRudder
FLT CosAileron
FLT SinAileron

modelfile // Holds the name of the model file, typically gltst.mdl

FLT ctx; FLT cty; FLT ctz // Direction cosines of direction t
FLT cwz; FLT cwy; FLT cwz // Direction cosines of direction w
FLT clx; FLT cly; FLT clz // Direction cosines of direction l

FLT rtdot; FLT rwdot; FLT rldot // Anti-clockwise rotation rates
                                // about the t, w and l axes

FLT eyex; FLT eyey; FLT eyez // Coordinates of a point on the
                                // line of sight from to eye to
                                // the origin (0.0, 0.0, 0.0).
FLT eyedistance // The distance between the eye
                                // and the origin.

FLT cent; FLT cenw; FLT cenl

// The next variables must be in consecutive locations
// since @vvec is passed to loadmodel.
vvec      // Vector of 32-bit floating point numbers
          // holding the vertex attributes.
vvecsize  // The number of numbers in vvec.
ivec      // Vector of 16-bit unsigned integers
ivecsize  // The number of 16-bit integers in ivec
dvec      // The display items vector
dvecsize  // The number of values in dvec

VertexBuffer // To hold all the vertex data we ever need.
IndexBuffer  // To hold all the index data we ever need.

projectionMatrix // is the matrix used by the vertex shader
                // to transform the vertex coordinates to
                // screen coordinates.

```



```

    workMatrix      // is used when constructing the projection matrix.
}

LET get16(v, i) = VALOF
{ LET w = 0
  LET p = 2*i
  LET a, b = v%p, v%(p+1)
  (@w)%0 := 1
  TEST (w & 1) = 0
  THEN RESULTIS (a<<8) + b // Big ender m/c
  ELSE RESULTIS (b<<8) + a // Little ender m/c
}

LET start() = VALOF
{ LET m1 = VEC 15
  LET m2 = VEC 15
  LET argv = VEC 50
  LET modelfile = "tigermothmodel.mdl"

  projectionMatrix, workMatrix := m1, m2

  UNLESS rdargs("-d/s,-a/s", argv, 50) DO
  { writef("Bad arguments for gltst*n")
    RETURN
  }

  debug := argv!0 // -d/s
  IF argv!1 DO // -a/s
    modelfile := "gltst.mdl"

  UNLESS glInit() DO
  { writef("nOpenGL not available*n")
    RESULTIS 0
  }

  writef("start: calling glMkScreen*n")
  // Create an OpenGL window
  screenxsize := glMkScreen("OpenGL First Test", 800, 680)
  screenysize := result2
  UNLESS screenxsize DO
  { writef("nUnable to create an OpenGL window*n")
    RESULTIS 0
  }
  writef("Screen Size is %n x %n*n", screenxsize, screenysize)
}

```

```

glprog := sys(Sys_gl, GL_MkProg)
writef("=> glprog=%n*n", glprog);

IF glprog<0 DO
{ writef("*nUnable to create a GL program*n")
  RESULTIS 0
}

// Read and Compile the vertex shader
writef("start: calling CompileV(%n,glstVshader.sdr) ",glprog)
Vshader := Compileshader(glprog, TRUE, "glstVshader.sdr")
writef("=> Vshader=%n*n", Vshader)

// Read and Compile the fragment shader
writef("start: calling CompileF(%n,glstFshader.sdr) ",glprog)
Fshader := Compileshader(glprog, FALSE, "glstFshader.sdr")
writef("=> Fshader=%n*n", Fshader)

// Link the program
writef("start: calling glLinkProg(%n)*n", glprog)
UNLESS sys(Sys_gl, GL_LinkProgram, glprog) DO
{ writef("*nUnable to link a GL program*n")
  RESULTIS 0
}

//writef("start: calling glUseProgram(%n)*n", glprog)
sys(Sys_gl, GL_UseProgram, glprog)

// Get attribute locations after linking
VertexLoc := sys(Sys_gl, GL_GetAttribLocation, glprog, "g_vVertex")
ColorLoc  := sys(Sys_gl, GL_GetAttribLocation, glprog, "g_vColor")
DataLoc   := sys(Sys_gl, GL_GetAttribLocation, glprog, "g_vData")

writef("VertexLoc=%n*n", VertexLoc)
writef("ColorLoc=%n*n", ColorLoc)
writef("DataLoc=%n*n", DataLoc)

// Get uniform locations after linking
MatrixLoc := sys(Sys_gl, GL_GetUniformLocation, glprog, "matrix")
ControlLoc := sys(Sys_gl, GL_GetUniformLocation, glprog, "control")

writef("MatrixLoc=%n*n", MatrixLoc)
writef("ControlLoc=%n*n", ControlLoc)

// Load model

```

```

writef("Calling loadmodel file=%s*n", modelfile)
UNLESS loadmodel(modelfile, @vvec) DO
{ writef("Unable to load model: %s*n", modelfile)
  RESULTIS 0
}

IF debug DO
{ // Output the vertex and index data
  // as a debugging aid
  writef("Vertex data*n")
  FOR i = 0 TO vvecsize-1 DO
  { IF i MOD 8 = 0 DO writef("i3: ", i)
    writef(" %8.3f", vvec!i)
  }
  writef("Index data*n")
  FOR i = 0 TO ivecsize-1 DO
  { IF i MOD 10 = 0 DO writef("i6: ", i)
    writef(" %i5", get16(ivec, i))
  }
  writef("Display data item*n")
  FOR i = 0 TO dvecsize-1 BY 3 DO
    writef(" %i5 %i5 %i5*n", dvec!i, dvec!(i+1), dvec!(i+2))
  newline()
}

sys(Sys_gl, GL_Enable, GL_DEPTH_TEST) // This call is necessary
sys(Sys_gl, GL_DepthFunc, GL_LESS)    // This the default

// A pixel written if incoming depth < buffer depth
// This assumes positive Z is into the screen, but
// remember the depth test is performed after all other
// transformations have been done.

// Setup the model using OpenGL objects in the graphics server's
// memory.
writef("start: vvecsize=%n*n", vvecsize)
VertexBuffer := sys(Sys_gl, GL_GenVertexBuffer, vvecsize, vvec)
// VertexBuffer is the name (a positive integer) of the vertex buffer.

// Tell GL the positions in vvec of the xyz fields,
// ie the first 3 words of each 8 word item in vvec
writef("start: GL_EnableVertexAttribArray VertexLoc==%n*n", VertexLoc)
// VertexLoc is the location of the variable g_vVertex used
// by the vertex shader.
sys(Sys_gl, GL_EnableVertexAttribArray, VertexLoc);

```

```

sys(Sys_gl, GL_VertexData,
    VertexLoc,    // Attribute number for xyz data
    3,            // 3 floats for xyz
    8,            // 8 floats per vertex item in vertexData
    0)           // Offset in words of the xyz data

writef("start: VertexData xyz data copied to graphics object %n*n", VertexBuffer)

// Tell GL the positions in vvec of the rgb fields,
// ie the second 3 words of each 8 word item in vvec
sys(Sys_gl, GL_EnableVertexAttribArray, ColorLoc);
sys(Sys_gl, GL_VertexData,
    ColorLoc,    // Attribute number rgb data
    3,            // 3 floats for rgb data
    8,            // 8 floats per vertex item in vertexData
    3)           // Offset in words of the rgb data

writef("start: ColourData rgb data copied to graphics object %n*n", VertexBuffer)

// Tell GL the positions in vvec of the kd fields,
// ie word 6 of each 8 word item in vvec
sys(Sys_gl, GL_EnableVertexAttribArray, DataLoc);
sys(Sys_gl, GL_VertexData,
    DataLoc,    // Attribute number kd data
    2,            // 2 floats for kd data
    8,            // 8 floats per vertex item in vertexData
    6)           // Offset in words of the kd data

writef("start: VertexData kd data copied to graphics object %n*n", VertexBuffer)

freevec(vvec) // Free vvec since all its elements have
              // been sent to the graphics server.
vvec := 0

writef("start: ivecsize=%n*n", ivecsize)
writef("start: GenIndexBuffer   ivec=%n ivecsize=%n*n", ivec, ivecsize)
IndexBuffer := sys(Sys_gl, GL_GenIndexBuffer, ivec, ivecsize)

writef("start: IndexData copied to graphics memory object %n*n", IndexBuffer)

freevec(ivec) // Free ivec since all its elements have
              // been sent to the graphics server.
ivec := 0

// Initialise the state

```

```

done      := FALSE
stepping := FALSE

// Set the initial direction cosines to orient t, w and l in
// directions -z, -x and y, ie viewing the aircraft from behind.

ctx, cty, ctz := 0.0, 0.0, -1.0
cwx, cwz := -1.0, 0.0, 0.0
clx, cly, clz := 0.0, 1.0, 0.0

rtdot, rwdot, rldot := 0.000, 0.001, 0.002 // Rotate the model slowly

cent, cenw, cenl := 0.0, 0.0, 0.0 // position in the aircraft to
// place at the centre of the screen.

eyex, eyey, eyez := 0.0, 0.0, 1.0

eyedistance := 80.000

IF debug DO
{ setvec( workMatrix, 16,
          2.0, 0.0, 0.0, 0.0, // Col 0
          1.0, 1.0, 1.0, 1.0, // Col 1
          0.0, 0.0, 1.0, 0.0, // Col 2
          0.0, 0.0, 0.0, 10.0) // Col 3

  setvec( projectionMatrix, 16,
          1.0, 2.0, 3.0, 4.0, // Col 0
          5.0, 6.0, 7.0, 8.0, // Col 1
          9.0, 10.0, 11.0, 12.0, // Col 2
          13.0, 14.0, 15.0, 16.0) // Col 3

  newline()
  prmat(workMatrix)
  writef("times*n")
  prmat(projectionMatrix)
  sys(Sys_gl, GL_M4mulM4, workMatrix, projectionMatrix, projectionMatrix)
  writef("gives*n")
  prmat(projectionMatrix)
  abort(1000)
}

UNTIL done DO
{ processevents()

```

```

// Only rotate the object if not stepping
UNLESS stepping DO
{ // If not stepping adjust the orientation of the model.
  rotate(rtdot, rwdot, rldot)
}

// Move the model frwad, left and up by specified amounts
setvec( projectionMatrix, 16,
        1.0,  0.0,  0.0, 0.0, // column 1
        0.0,  1.0,  0.0, 0.0, // column 2
        0.0,  0.0,  1.0, 0.0, // column 3
        cent, cenw, cenl, 1.0) // column 4

// Set the model rotation matrix from model
// coordinates (t,w,l) to world coordinates (x,y,z)
setvec( workMatrix, 16,
        ctx,  cty,  ctz, 0.0, // column 1
        cwx,  cwy,  cwz, 0.0, // column 2
        clx,  cly,  clz, 0.0, // column 3
        0.0,  0.0,  0.0, 1.0) // column 4

sys(Sys_gl, GL_M4mulM4, workMatrix, projectionMatrix, projectionMatrix)

// Rotate the model and eye until the eye is on the z axis

{ LET FLT ex, FLT ey, FLT ez = eyex, eyey, eyez
  LET FLT oq = glRadius2(ex, ez)
  LET FLT op = glRadius3(ex, ey, ez)
  LET FLT cos_theta = ez / oq
  LET FLT sin_theta = ex / oq
  LET FLT cos_phi   = oq / op
  LET FLT sin_phi   = ey / op

  // Rotate anti-clockwise about Y axis by angle theta
  setvec( workMatrix, 16,
          cos_theta, 0.0, sin_theta, 0.0, // column 1
          0.0, 1.0, 0.0, 0.0, // column 2
          -sin_theta, 0.0, cos_theta, 0.0, // column 3
          0.0, 0.0, 0.0, 1.0 // column 4
        )

  sys(Sys_gl, GL_M4mulM4, workMatrix, projectionMatrix, projectionMatrix)
}

```

```

// Rotate clockwise about X axis by angle phi
setvec( workMatrix, 16,
        1.0,    0.0,    0.0, 0.0,    // column 1
        0.0, cos_phi, -sin_phi, 0.0, // column 2
        0.0, sin_phi,  cos_phi, 0.0, // column 3
        0.0,    0.0,    0.0, 1.0)   // column 4

sys(Sys_gl, GL_M4mulM4, workMatrix, projectionMatrix, projectionMatrix)

// Change the origin to the eye position on the z axis by
// moving the model eyedistance in the negative z direction.
setvec( workMatrix, 16,
        1.0, 0.0,    0.0, 0.0, // column 1
        0.0, 1.0,    0.0, 0.0, // column 2
        0.0, 0.0,    1.0, 0.0, // column 3
        0.0, 0.0, -eyedistance, 1.0 // column 4
    )

sys(Sys_gl, GL_M4mulM4, workMatrix, projectionMatrix, projectionMatrix)
}

{ // Define the truncated pyramid for the view projection
  // using the frustrum transformation.
  LET FLT n, FLT f = 0.1, 5000.0
  LET FLT fan, FLT fsn = f+n, f-n
  LET FLT n2 = 2.0*n
  LET FLT l,  FLT r  = -0.5, 0.5
  LET FLT ral, FLT rsl = r+l, r-l
  LET FLT b,  FLT t  = -0.5, 0.5
  LET FLT tab, FLT tsb = t+b, t-b

  LET FLT aspect = FLOAT screenxsize / FLOAT screensize
  LET FLT fv = 2.0 / 0.5 // Half field of view at unit distance
  setvec( workMatrix, 16,
          fv/aspect, 0.0,    0.0, 0.0, // column 1
          0.0, fv,    0.0, 0.0, // column 2
          0.0, 0.0,    (f+n)/(n-f), -1.0, // column 3
          0.0, 0.0, (2.0*f*n)/(n-f), 0.0 // column 4
      )

  // This perspective matrix could be set more conveniently using
  // glSetPerspective library function defined in g/gl.b
  //glSetPerspective(workMatrix,
  //
  //                    aspect, // Aspect ratio

```

```

//          0.5, // Field of view at unit distance
//          0.1, // Distance to near limit
//          5000.0) // Distance to far limit

sys(Sys_gl, GL_M4mulM4, workMatrix, projectionMatrix, projectionMatrix)
}

// Send the resulting matrix to the uniform variable "matrix" for
// use by the vertex shader.
sys(Sys_gl, GL_UniformMatrix4fv, MatrixLoc, glprog, projectionMatrix)

// Calculate the cosines and sines of the control surfaces.
{ LET FLT RudderAngle = - rldot * 75.0
  CosRudder := sys(Sys_flt, fl_cos, RudderAngle)
  SinRudder := sys(Sys_flt, fl_sin, RudderAngle)
}

{ LET FLT ElevatorAngle = rwdot * 100.0
  CosElevator := sys(Sys_flt, fl_cos, ElevatorAngle)
  SinElevator := sys(Sys_flt, fl_sin, ElevatorAngle)
}

{ LET FLT AileronAngle = rtdot * 100.0
  CosAileron := sys(Sys_flt, fl_cos, AileronAngle)
  SinAileron := sys(Sys_flt, fl_sin, AileronAngle)
}

// Send them to the graphics hardware as elements of the
// uniform 4x4 matrix "control" for use by the vertex shader.
{ LET control = VEC 15
  FOR i = 0 TO 15 DO control!i := 0.0

  control!00 := CosRudder // 0 0
  control!01 := SinRudder // 0 1
  control!02 := CosElevator // 0 2
  control!03 := SinElevator // 0 3
  control!04 := CosAileron // 1 0
  control!05 := SinAileron // 1 1

  // Send the control values to the graphics hardware.
  sys(Sys_gl, GL_UniformMatrix4fv, ControlLoc, glprog, control)
}

// Draw a new image

```



```

    sys(Sys_gl, GL_ClearColour, 130, 130, 250, 255)
    sys(Sys_gl, GL_ClearBuffer) // Clear colour and depth buffers

    drawmodel()

    sys(Sys_gl, GL_SwapBuffers)
    //delay(0_020) // Delay for 1/50 sec
}

sys(Sys_gl, GL_DisableVertexAttribArray, VertexLoc)
sys(Sys_gl, GL_DisableVertexAttribArray, ColorLoc)
sys(Sys_gl, GL_DisableVertexAttribArray, DataLoc)

freevec(dvec) // Free the display items vector.
delay(0_050)
sys(Sys_gl, GL_Quit)

RESULTIS 0
}

AND Compileshader(prog, isVshader, filename) = VALOF
{ // Create and compile a shader whose source code is
  // in a given file.
  // isVshader=TRUE if compiling a vertex shader
  // isVshader=FALSE if compiling a fragment shader
  LET oldin = input()
  LET oldout = output()
  LET buf = 0
  LET shader = 0
  LET ramstream = findinoutput("RAM:")
  LET instream = findinput(filename)
  UNLESS ramstream & instream DO
  { writef("Compileshader: Trouble with i/o streams*n")
    RESULTIS -1
  }
}

//Copy shader program to RAM:
selectoutput(ramstream)
selectinput(instream)

{ LET ch = rdch()
  IF ch=endstreamch BREAK
  wrch(ch)
} REPEAT

```

```

wrch(0) // Place the terminating byte

selectoutput(oldout)
endstream(instream)
selectinput(oldin)

buf := ramstream!scb_buf

shader := sys(Sys_gl,
              (isVshader -> GL_CompileVshader, GL_CompileFshader),
              prog,
              buf)

endstream(ramstream)
RESULTIS shader
}

AND drawmodel() BE
{ // Draw the primitives using vertex and index data held in
  // graphics objects as specified by the display items in dvec.
  FOR p = 0 TO dvecsize-3 BY 3 DO
  { LET mode   = dvec!(p+0) // Points, Lines, Linestrip, etc.
    LET size   = dvec!(p+1) // Number of index elements.
    LET offset = dvec!(p+2) // Offset in the index vector.

//writef("drawmodel: mode=%n, offset=%n size=%n*n", mode, offset, size)

    sys(Sys_gl, GL_DrawElements,
        mode,      // 1=points, 2=lines, 3=linestrip, etc
        size,      // Number of index elements to use.
        2*offset) // The start position (bytes) in the index vector.
  }
}

AND processevents() BE WHILE getevent() SWITCHON eventtype INTO
{ DEFAULT:
  //writef("processevents: Unknown event type = %n*n", eventtype)
  LOOP

  CASE sdle_keydown:
    SWITCHON capitalch(eventa2) INTO
    { DEFAULT: LOOP

      CASE 'Q': done := TRUE
        LOOP

```

```

CASE 'A': abort(5555)
          LOOP

// Move the aircraft relative to the centre of the screen,
// 6 inches each time.
CASE 'F': cent := cent + 0.5; LOOP // Foward in direction t
CASE 'B': cent := cent - 0.5; LOOP // Backward
CASE 'L': cenw := cenw + 0.5; LOOP // To the left in direction w
CASE 'R': cenw := cenw - 0.5; LOOP // To the right
CASE 'U': cenl := cenl + 0.5; LOOP // Upward indirection l
CASE 'D': cenl := cenl - 0.5; LOOP // Downward

CASE 'P': // Print direction cosines and other data
          newline()
          writef("ct      %9.6f %9.6f %9.6f rtdot=%9.6f*n",
                  ctx, cty, ctz, rtdot)
          writef("cw      %9.6f %9.6f %9.6f rwdot=%9.6f*n",
                  cwz, cwz, cwz, rwdot)
          writef("cl      %9.6f %9.6f %9.6f rldot=%9.6f*n",
                  clx, cly, clz, rldot)
          newline()
          writef("eyepos %9.3f %9.3f %9.3f*n",
                  eyex, eyey, eyez)
          writef("eyedistance = %9.3f*n", eyedistance)
          LOOP

CASE 'S': stepping := ~stepping
          LOOP

CASE '0': eyex, eyez := 0.000, 1.000; LOOP
CASE '1': eyex, eyez := 0.707, 0.707; LOOP
CASE '2': eyex, eyez := 1.000, -0.000; LOOP
CASE '3': eyex, eyez := 0.707, -0.707; LOOP
CASE '4': eyex, eyez := 0.000, -1.000; LOOP
CASE '5': eyex, eyez := -0.707, -0.707; LOOP
CASE '6': eyex, eyez := -1.000, 0.000; LOOP
CASE '7': eyex, eyez := -0.707, 0.707; LOOP

CASE '=':
CASE '+': eyedistance := eyedistance * 1.1; LOOP

CASE '_':
CASE '-': IF eyedistance >= 1.0 DO
          eyedistance := eyedistance / 1.1

```

```

        LOOP

        CASE '>':CASE ',.':    rldot := rldot + 0.0005
                                IF rldot> 0.0060 DO rldot := 0.0060
                                LOOP
        CASE '<':CASE ',.':    rldot := rldot - 0.0005
                                IF rldot<-0.0060 DO rldot := -0.0060
                                LOOP

        CASE sdle_arrowdown:  rwdot := rwdot + 0.0005
                                IF rwdot> 0.0060 DO rwdot := 0.0060
                                LOOP
        CASE sdle_arrowup:    rwdot := rwdot - 0.0005
                                IF rwdot<-0.0060 DO rwdot := -0.0060
                                LOOP

        CASE sdle_arrowleft:  rtdot := rtdot + 0.0005
                                IF rtdot> 0.0060 DO rtdot := 0.0060
                                LOOP
        CASE sdle_arrowright: rtdot := rtdot - 0.0005
                                IF rtdot<-0.0060 DO rtdot := -0.0060
                                LOOP

    }
    LOOP

    CASE sdle_quit:           // 12
        writef("QUIT*n");
        sys(Sys_gl, GL_Quit)
        LOOP
}

AND rotate(FLT t, FLT w, FLT l) BE
{ // Rotate the orientation of the aircraft
  // t, w and l are assumed to be small and cause
  // rotation about axis t, w, l. Positive values cause
  // anti-clockwise rotations about their axes.

  LET FLT tx =   ctx - l*cwx + w*clx
  LET FLT wx =  l*ctx +   cwx - t*clx
  LET FLT lx = -w*ctx + t*cwx +   clx

  LET FLT ty =   cty - l*cwy + w*cly
  LET FLT wy =  l*cty +   cwy - t*cly
  LET FLT ly = -w*cty + t*cwy +   cly

```

```

LET FLT tz =    ctz - l*cwz + w*clz
LET FLT wz =  l*ctz +    cwz - t*clz
LET FLT lz = -w*ctz +  t*cwz +    clz

ctx, cty, ctz := tx, ty, tz
cwx, cwy, cwz := wx, wy, wz
clx, cly, clz := lx, ly, lz

adjustlength(@ctx);    adjustlength(@cwx);    adjustlength(@clx)
adjustortho(@ctx, @cwx); adjustortho(@ctx, @clx); adjustortho(@cwx, @clx)
}

AND adjustlength(v) BE
{ // Make v a vector of unit length
  LET FLT r = glRadius3(v!0, v!1, v!2)
  v!0 := v!0 / r
  v!1 := v!1 / r
  v!2 := v!2 / r
}

AND adjustortho(a, b) BE
{ // Attempt to keep the unit vector b orthogonal to a
  LET FLT a0, FLT a1, FLT a2 = a!0, a!1, a!2
  LET FLT b0, FLT b1, FLT b2 = b!0, b!1, b!2
  LET FLT corr = a0*b0 + a1*b1 + a2*b2
  b!0 := b0 - a0 * corr
  b!1 := b1 - a1 * corr
  b!2 := b2 - a2 * corr
}

AND prmat(m) BE
{ // m is a 4x4 matrix as a sequence of columns.
  writef(" %8.3f %8.3f %8.3f %8.3f*n", m!0, m!4, m! 8, m!12)
  writef(" %8.3f %8.3f %8.3f %8.3f*n", m!1, m!5, m! 9, m!13)
  writef(" %8.3f %8.3f %8.3f %8.3f*n", m!2, m!6, m!10, m!14)
  writef(" %8.3f %8.3f %8.3f %8.3f*n", m!3, m!7, m!11, m!15)
}

AND prv(v) BE
{ // v is a vector of four elements.
  writef(" %8.3f %8.3f %8.3f %8.3f*n", v!0, v!1, v!2, v!3)
}

```

If the `-a` option is given this program reads `glfst.mdl`, which was hand written, to obtain the vertex and index data representing the cube-like missile

with control surfaces. The file `gltst.mdl` is as follows.

```
// This file holds the specification of a model used by gltst.b
// It models a coloured cube somewhat modified to look like a
// missile with ailerons, elevator and rudder.

// .mdl files are normally created by program but this one
// is hand written.

// Implemented by Martin Richards (c) June 2014

// Modified 4 June 2018

// OpenGL uses the right hand convention so for world coordinates.

// With your right hand, point north with your first finger, point west
// with your second finger and point upwards with your thumb. These
// correspond to the directions of the first, second and third components
// of a right handed coordinate system.

// So our coordinate systems use the same convention.

// Real world coordinates

// n is towards the north
// w is towards the west
// h is upwards

// Screen coordinates

// x to the right
// y upwards
// z orthogonal to x and y towards the viewer, so
// negative z is into the screen.

// The model is at the origin in real world coordinates
// with the direction of thrust pointing north
// direction of the left wing pointing west
// and the direction of lift being up.

// Vertices are represented by 8 values
//      n w l  r g b  k d

//      k = 0   fixed surface
```

```

// k = 1  rudder      d is the distance from the rudder hinge
// k = 2  elevator   d is the distance from the elevator hinge
// k = 3  left aileron d is the distance from the aileron hinge
// k = 4  right aileron d is the distance from the aileron hinge
// k = 5  a point on the ground, d=0

// Syntax

// vs n      Set the size of the vertex vector.
// is n      Set the size of the index vector.
// ds n      Allocate the display items vector. n is the number of
//            display items required.
// rgb r g b Set the current colour.
// kd k d    Set current k and d.
// v  x y z  Specify a vertex with coords xyz with current rgb and kd
// n         Set another index vector element
// d m n offset A display item. mode is the mode to use eg 5 for triangles,
//            n is the number of index values to use and offset is
//            the starting position in the index vector.

// z          End of file

// Start of the model. The dimensions are in feet.

vs 384 // 48*8 48 vertices with 8 attributes each

kd 0.0 0.0

rgb 1.0 1.0 0.0 // yellow

v +10.000 +5.000 -5.000 // 0 front left bottom
v +10.000 -5.000 -5.000 // 1 front right bottom
v -10.000 -5.000 -5.000 // 2 back right bottom
v -10.000 +5.000 -5.000 // 3 back left bottom

rgb 0.0 1.0 0.0 // green

v +10.000 -5.000 -5.000 // 4 front right bottom
v +10.000 -5.000 +5.000 // 5 front right top
v -10.000 -5.000 +5.000 // 6 back right top
v -10.000 -5.000 -5.000 // 7 back right bottom

rgb 0.2 0.4 1.0 // light blue

```

```

v +10.000 -5.000 +5.000 // 8 front right top
v +10.000 +5.000 +5.000 // 9 front left top
v -10.000 +5.000 +5.000 // 10 back left top
v -10.000 -5.000 +5.000 // 11 back right top

rgb 1.0 0.0 0.0 // red

v +10.000 +5.000 -5.000 // 12 front left bottom
v -10.000 +5.000 -5.000 // 13 back left bottom
v -10.000 +5.000 +5.000 // 14 back left top
v +10.000 +5.000 +5.000 // 15 front left top

// Rudder

rgb 0.0 0.0 0.0 // black

v -10.000 0.000 -5.000 // 16 back middle bottom
v -10.000 0.000 5.000 // 17 back middle top
kd 1.0 2.5
v -12.500 0.000 5.000 // 18 end middle top
v -12.500 0.000 -5.000 // 19 end middle bottom
kd 0.0 0.0

// Elevator

rgb 1.0 1.0 1.0 // white

v -10.000 +5.000 0.000 // 20 back left middle
v -10.000 -5.000 0.000 // 21 back right middle
kd 2.0 3.0
v -13.000 -5.000 0.000 // 22 end right middle
v -13.000 +5.000 0.000 // 23 end left middle
kd 0.0 0.0

// Left Aileron

rgb 0.3 0.3 0.3 // gray

v +10.000 +5.000 0.000 // 24 back left middle
v +10.000 +9.000 0.000 // 25 back fleft middle
kd 3.0 2.5
v +7.500 +9.000 0.000 // 26 end fleft middle
v +7.500 +5.000 0.000 // 27 end left middle
kd 0.0 0.0

```



```
// Right Aileron

rgb 0.3 0.3 0.3 // gray

v +10.000 -5.000 0.000 // 28 back right middle
v +10.000 -9.000 0.000 // 29 back right middle
kd 4.0 2.5
v +7.500 -9.000 0.000 // 30 end right middle
v +7.500 -5.000 0.000 // 31 end right middle
kd 0.0 0.0

// nose top

rgb 0.3 0.3 0.8 // blue gray

v 10.000 5.000 5.000 // 32 front left top
v 10.000 -5.000 5.000 // 33 front right top
v 40.000 -2.500 2.500 // 34 nose right top
v 40.000 2.500 2.500 // 35 nose left top

// nose left

rgb 0.8 0.3 0.3 // red gray

v 10.000 5.000 5.000 // 36 front left top
v 10.000 5.000 -5.000 // 37 front left bottom
v 40.000 2.500 -2.500 // 38 nose left bottom
v 40.000 2.500 2.500 // 39 nose left top

// nose right

rgb 0.3 0.8 0.3 // green gray

v 10.000 -5.000 5.000 // 40 front right top
v 10.000 -5.000 -5.000 // 41 front right bottom
v 40.000 -2.500 -2.500 // 42 nose right low
v 40.000 -2.500 2.500 // 43 nose right high

// nose bottom

rgb 0.3 0.8 0.8 // yellow gray

v 10.000 5.000 -5.000 // 44 front left bottom
v 10.000 -5.000 -5.000 // 45 front right bottom
```

```

v 40.000 -2.500 -2.500 // 46 nose right low
v 40.000 2.500 -2.500 // 47 nose left low

// We will draw the to missile using a triangle strip for its
// main body followed by triangles for th control surfaces.
// Note that some of the triangles in the triangle strip are null.

is 63 // Number of 16--bit unsigned integers in the index array.

// Triangle strips at 0
0 3 1 2 // 0 yellow base
2
7 4 6 5 // 5 green right side
5
8 11 9 10 // 10 blue top
10
14 15 13 12 // 15 red left
12
44 45 47 46 // 20 yellow gray nose bottom
42
42 43 41 40 // 25 green gray nose right
40
33 34 32 35 // 30 blue gray nose top
35
39 38 36 37 // 35 red gray nose left

// Triangles starting at index position 39
16 17 18 16 18 19 // 39 Black rudder
20 21 22 20 22 23 // 45 white elevator
24 25 26 24 26 27 // 51 gray left aileron
28 29 30 28 30 31 // 57 gray right aileron
// 63

// The entire image could have been drawn using one display item
// specifying a single triangle strip, but, as a demonstration, we use
// two display items are used here. The first is a triangle strip and
// the second just specifies indeividual triangles.

ds 2 // The number of display items.
d 6 39 0 // The missile body as a triangle strip.
d 5 24 39 // The control surfaces as triangles.

z // End of mdl data.

```

The program also reads the vertex and fragment shader programs from file.

These are call `glTstVshader.sdr` and `glTstFshader.sdr`. The vertex shader is as follows.

```
uniform mat4 matrix; // Rotation and translation matrix
uniform mat4 control; // Control matrix

attribute vec4 g_vVertex;
attribute vec4 g_vColor;
attribute vec2 g_vData; // data[0]=ctrl data[1]=value

varying vec4 g_vVColor;

void main()
{ float ctrl = g_vData[0];
  // 1.0 rudder 2.0 elevator 3.0 left aileron 4.0 right aileron

  g_vVColor = g_vColor;

  // For fun, use the xyz coordinates to adjust the colour a little
  //g_vVColor = g_vColor*0.9 + g_vVertex * 0.40;

  // Deal with the control surfaces

  if(ctrl > 0.0) {
    float dist = g_vData[1]; // Distance from the hinge in feet

    vec4 Pos = g_vVertex; // Coords of the vertex

    Pos.w = 1.0;

    if(ctrl==1.0) { // Rudder
      float cr = control[0][0];
      float sr = control[0][1];
      Pos.x += dist * (1.0-cr);
      Pos.y += dist * sr;
    }
    if(ctrl==2.0) { // Elevator
      float ce = control[0][2];
      float se = control[0][3];
      Pos.x += dist * (1.0 - ce);
      Pos.z += dist * se;
    }
    if(ctrl==3.0) { // Left aileron
      float ca = control[1][0];
      float sa = control[1][1];
      Pos.x += dist * (1.0 - ca);
```

```

    Pos.z += dist * sa;
}
if(ctrl==4.0) { // Right aileron
    float ca = control[1][0];
    float sa = control[1][1];
    Pos.x += dist * (1.0 - ca);
    Pos.z -= dist * sa;
}
// Rotate and translate the control surface
gl_Position = (matrix * Pos);

} else {

    // Rotate and translate the model
    gl_Position = (matrix * g_vVertex);
}
}

```

The fragment shader is called `glTstFshader.sdr` and is as follows.

```

#ifdef GL_ES
//precision mediump float;
#endif

varying    vec4 g_vVColor;

void main()
{ vec4 Col = g_vVColor;
  //if ((g_vVColor.r<100.0) && (g_vVColor.g<100.0) && (g_vVColor.b<100.0))
  //{ Col.r = 0.5;
  //}
  gl_FragColor = Col;
}

```

```

#ifdef GL_ES
//precision mediump float;
#endif

varying    vec4 g_vVColor;

```

```

void main()
{ vec4 Col = g_vVColor;
  //if ((g_vVColor.r<100.0) && (g_vVColor.g<100.0) && (g_vVColor.b<100.0))
  //{ Col.r = 0.5;
  //}
  gl_FragColor = Col;
}

```

If `glfst` is called without the `-a` option it load the model from `tigermothmodel.mdl` giving a simple representation of a tigermoth biplane. The `.mdl` file was created by running the program `mktigermothmodel`. This model was developed using `glfst` but in due course it will be possible to fly it using `gltiger.b`, but this is still under development.

When `gltiger` is called it displays a tigermoth, a runway and some mountainous terrain. This image is composed of a large number of coloured triangles in 3D, giving a typical image such as the following.



The 3D triangles are specified in the file `tigermothmodel.mdl` whose structure is similar to that of `glfst.mdl` given above. It is convenient to generate `tigermothmodel.mdl` using a program (`mktigermothmodel.b`) whose is as follows.

```
/*
```

```
This program creates the file tigermothmodel.mdl representing a tiger
```

moth aircraft and the land in .mdl format for use by the OpenGL program `gltiger.b`

Implemented by Martin Richards (c) February 2014

History

08/05/18

Extensively modified to generate the new .mdl model file, using floating point and the FLT feature.

OpenGL vertex data is stored as follows

```
vec3 position -- t(direction of thrust), w(direction of left wing),
              -- and l(diretion of lift)    floating point values
vec3 colour  -- r, g, b    floating point values
int  k       -- =1 rudder,
              =2 elevator,
              =3 left aileron,
              =4 right aileron
              =5 landscape and runway
float d      -- distance from hinge in inches, to be multiplied
              by the sine or cosine of control surface angle.
```

The program outputs vertex and index items representing triangle. It used a self entending vector for the vertices so that when vertices can be reused.

The new version of the .mdl language is as follows.

```
// Vertices are represented by 8 values
//      n w l  r g b  k d

//  k = 0  fixed surface
//  k = 1  rudder      d is the distance from the rudder hinge
//  k = 2  elevator    d is the distance from the elevator hinge
//  k = 3  left aileron d is the distance from the aileron hinge
//  k = 4  right aileron d is the distance from the aileron hinge

// Syntax

// vs n          Set the size of the vertex vector
// is n          Set the six of the index data
// rgb r g b     Set the current colour
```

```

// kd k d          Set current k and d
// v  x y z        Specify a vertex with coords xyz with current rgb and kd
// n               Set an index value
// ds n           Set the size of the display items vector
// d mode size offset Set the mode, size and offset of a display item.

// z              End of file

*/

GET "libhdr"

GLOBAL {
  stdin:ug
  stdout

  FLT cur_r; FLT cur_g; FLT cur_b // The current colour.
  FLT cur_k; FLT cur_d           // The current k and d values

  addvertex // Find or create a vertex, returning the vertex number
  vertexcount // Index of the next vertex to be created
  indexcount // Count of index values
  hashtable // hash table for verices

  spacev // To hold vertices to be placed in the hash table
  spacet
  spacep
  newvec

  tracing
  tostream
}

MANIFEST {
// Vertex structure
v_next=0 // List of vertices in vertex number order.
v_x; v_y; v_z
v_r; v_g; v_b
v_k; v_d // Control surface, distance from hinge.
v_n // Vertex number.
v_chain // Hash chain to allow efficient lookup.
v_size // Number of words in a vertex node.
v_upb = v_size-1

// Vertices are held in a hash table so that their vertex numbers

```

```

// can be reused.
hashtabsize = 541
hashtabupb = hashtabsize-1

spaceupb = 100_000 * v_size

FLT runwaylength = 600.000
FLT runwaywidth  = 40.000
FLT landsize     = 20_000.000

FLT Left  = 1.0
FLT Right = -1.0
}

LET start() = VALOF
{ LET stdin = input()
  LET stdout = output()
  LET toname = "tigermothmodel.mdl" // The default target file.
  LET ht = VEC hashtabsize
  LET argv = VEC 50

  vertexcount := 0
  indexcount := 0

  // Initialize the vertex list.

  cur_r, cur_g, cur_b := -1.0, -1.0, -1.0 // The current colour.
  cur_k, cur_d      := -1.0, -1.0      // The current k and d values

  hashtab := ht
  FOR i = 0 TO hashtabupb DO hashtab!i := 0

  UNLESS rdargs("to/k,-t/s", argv, 50) DO
  { writef("Bad arguments for mktigermothmodel*n")
    RESULTIS 0
  }

  IF argv!0 DO toname := argv!0
  tracing := argv!1

  tostream := findoutput(toname)
  UNLESS toname DO
  { writef("trouble with file: %s*n", toname)
    RESULTIS 0
  }
}

```



```

spacev := getvec(spaceupb)
spacet := @spacev!spaceupb
spacep := spacet

UNLESS spacep DO
{ writef("Unable to allocate %n words of space*n")
  GOTO fin
}

selectoutput(tostream)

mktigermothmodel()

endstream(tostream)
selectoutput(stdout)
writef("Space used %n out of %n*n", spacet-spacep, spacet)

fin:
  IF spacev DO freevec(spacev)
  RESULTIS 0
}

AND newvec(upb) = VALOF
{ LET p = spacep - upb - 1
  IF p < spacev DO
  { writef("error: spacev is not large enough*n")
    abort(999)
  }
  spacep := p
//writef("newvec: spacev=%n spacep=%n*n", spacev, spacep)
  RESULTIS p
}

AND rgb(r, g, b) BE // r, g and b are integers in range 0..255
{ // First scale r, g and b to range 0.0 .. 1.0
  LET FLT new_r = (FLOAT r)/255.0
  LET FLT new_g = (FLOAT g)/255.0
  LET FLT new_b = (FLOAT b)/255.0
  UNLESS new_r=cur_r & new_g=cur_g & new_b=cur_b DO
  { cur_r, cur_g, cur_b := new_r, new_g, new_b
    writef("rgb %6.3f %6.3f %6.3f*n", cur_r, cur_g, cur_b)
  }
}
}

```

```

AND kd(FLT k, FLT d) BE
{ UNLESS k=cur_k & d=cur_d DO
  { writef("kd %6.3f %6.3f*n", k, d)
    cur_k, cur_d := k, d
  }
}

AND vertex(FLT t, FLT w, FLT l) = VALOF
{ // Find vertex t,w,l, cur_g,cur_g,cur_b, cur_k,cur_d
  // creating it if necessary and return its vertex number.

  LET hashval = ((FIX(t * 1234) +
    FIX(w * 2345) +
    FIX(l * 3456) +
    FIX(cur_r * 4567) +
    FIX(cur_g * 5678) +
    FIX(cur_b * 6789) +
    FIX(cur_k * 4321) +
    FIX(cur_d * 4321)) >> 1) MOD hashtabsize

  LET p = hashtab!hashval
  //writef("vertex: t=%9.3f w=%9.3f l=%9.3f hashval=%i3 p=%n*n", t, w, l, hashval, p)
  WHILE p DO // Search down the hash chain
  { IF p!v_x=t & p!v_y=w & p!v_z=l &
    p!v_r=cur_r & p!v_g=cur_g & p!v_b=cur_b &
    p!v_k=cur_k & p!v_d=cur_d RESULTIS p!v_n // Vertex found
    p := p!v_chain
  }

  // writef("vertex: p=0 so make a new vertex node*n")
  // Vertex not found, so create a new one.
  p := newvec(v_upb)
  // writef("vertex: new p = %n*n", p)
  //abort(1000)
  p!v_x, p!v_y, p!v_z := t, w, l
  p!v_r, p!v_g, p!v_b := cur_r, cur_g, cur_b
  p!v_k, p!v_d := cur_k, cur_d
  p!v_n := vertexcount
  p!v_chain := hashtab!hashval
  hashtab!hashval := p

  writef("v %13.3f %13.3f %13.3f // %i3*n", t,w,l, vertexcount)
  vertexcount := vertexcount+1
  RESULTIS p!v_n
}

```

```

AND vertexrgb(FLT t, FLT w, FLT l, r,g,b) = VALOF
{ rgb(r,g,b)
  RESULTIS vertex(t,w,l)
}

AND vertexkd(FLT t, FLT w, FLT l, k,d) = VALOF
{ kd(k, d)
  RESULTIS vertex(t,w,l)
}

AND landvertex(FLT n, FLT w, FLT h, r,g,b) = VALOF
{ rgb(r,g,b)
  RESULTIS vertexkd(n,w,h, 5.0, 0.0)
}

AND triangle(a,b,c, d,e,f, g,h,i) BE
{ // a, b, c are in directions forward, left and up
  // store as openGL t,w,l which are forward, left, up.
  // ie set t, w, l to a, b, c
  // do the same for def and ghi
  LET v0, v1, v2 = ?, ?, ?
  kd(0.0, 0.0)
  v0 := vertex(a,b,c)
  v1 := vertex(d,e,f)
  v2 := vertex(g,h,i)
  writef("%i4 %i4 %i4*n", v0, v1, v2)
  indexcount := indexcount+3
}

AND quad(a,b,c, d,e,f, g,h,i, j,k,l) BE
{ // a, b, c are in directions forward, left and up
  // store as openGL t,w,l which are forward,left, up
  // ie set x, y, z to a, b, c
  // do the same for def, ghi and jkl
  LET v0, v1, v2, v3 = ?, ?, ?, ?
  kd(0.0, 0.0)
  v0 := vertex(a,b,c)
  v1 := vertex(d,e,f)
  v2 := vertex(g,h,i)
  v3 := vertex(j,k,l)
  writef("%i4 %i4 %i4*n", v0, v1, v2)
  writef("%i4 %i4 %i4*n", v0, v2, v3)
  indexcount := indexcount+6
}

```

```

AND trianglekd(FLT a, FLT b, FLT c, FLT k1, FLT d1,
               FLT d, FLT e, FLT f, FLT k2, FLT d2,
               FLT g, FLT h, FLT i, FLT k3, FLT d3) BE
{ // a, b, c are in directions forward, left and up
  // store as OpenGL t,w,l which are forward, left, up
  // ie set x, y, z to a, b, c
  // do the same for def and ghi
  LET v0, v1, v2 = ?, ?, ?
  v0 := vertexkd(a,b,c, k1,d1)
  v1 := vertexkd(d,e,f, k2,d2)
  v2 := vertexkd(g,h,i, k3,d3)
  writef("%i4 %i4 %i4*n", v0, v1, v2)
  indexcount := indexcount+3
}

AND quadkd(FLT a, FLT b, FLT c, FLT k1, FLT d1,
           FLT d, FLT e, FLT f, FLT k2, FLT d2,
           FLT g, FLT h, FLT i, FLT k3, FLT d3,
           FLT j, FLT k, FLT l, FLT k4, FLT d4) BE
{ // a, b, c are in directions forward, left and up
  // store as OpenGL t,w,l which are forward, left, up
  // ie set x, y, z to a, b, c
  // do the same for def, ghi and jkl
  LET v0, v1, v2, v3 = ?, ?, ?, ?
  v0 := vertexkd(a,b,c, k1,d1)
  v1 := vertexkd(d,e,f, k2,d2)
  v2 := vertexkd(g,h,i, k3,d3)
  v3 := vertexkd(j,k,l, k4,d4)
  writef("%i4 %i4 %i4*n", v0, v1, v2)
  writef("%i4 %i4 %i4*n", v0, v2, v3)
  indexcount := indexcount+6
}

AND triangleland(FLT x1, FLT y1, FLT z1, r1,g1,b1,
                 FLT x2, FLT y2, FLT z2, r2,g2,b2,
                 FLT x3, FLT y3, FLT z3, r3,g3,b3) BE
{ // 3D coords and colours of the the vertices of a triangle
  // of landscape or runway (ie with k=5.0 and d=0.0
  LET v0, v1, v2 = ?, ?, ?
  kd(5.0, 0.0)
  v0 := vertexrgb(x1,y1,z1, r1,g1,b1)
  v1 := vertexrgb(x2,y2,z2, r2,g2,b2)
  v2 := vertexrgb(x3,y3,z3, r3,g3,b3)
  writef("%i4 %i4 %i4*n", v0, v1, v2)
  indexcount := indexcount+3
}

```

```

}

AND quadland(FLT x1, FLT y1, FLT z1, r1,g1,b1,
             FLT x2, FLT y2, FLT z2, r2,g2,b2,
             FLT x3, FLT y3, FLT z3, r3,g3,b3,
             FLT x4, FLT y4, FLT z4, r4,g4,b4) BE
{ // 3D coords and colours of the the vertices of a quad
  // of landscape or runway
  LET v0, v1, v2, v3 = ?, ?, ?, ?
  kd(5.0, 0.0)
  v0 := vertexrgb(x1,y1,z1, r1,g1,b1)
  v1 := vertexrgb(x2,y2,z2, r2,g2,b2)
  v2 := vertexrgb(x3,y3,z3, r3,g3,b3)
  v3 := vertexrgb(x4,y4,z4, r4,g4,b4)
  writef("%i4 %i4 %i4*n", v0, v1, v2)
  writef("%i4 %i4 %i4*n", v0, v2, v3)
  indexcount := indexcount+6
}

AND mktigermothmodel() BE
{ // The origin is the centre of the tigermoth
  // For landscape and the runway, the origin is the start of the runway

  // The tigermoth coordinates are as follows

  // first t is the distance forward of the centre of gravity
  // second w is the distance left of the centre of gravity
  // third l is the distance above the centre of gravity

  writef("// Tiger Moth Model*n")
  newline()

  // CORRECT THESE WHEN THE CORRECT VALUES ARE KNOWN.
  writef("vs 15000 // Size of the vertex vector in words*n")
  writef("is 4000 // Size of the index vector in half words*n")

  writef("// Cockpit floor*n")
  rgb(90,80,30)
  kd(0.0, 0.0)
  quad( 1.000, 0.800, 0.000,
        1.000,-0.800, 0.000,
        -5.800,-0.800, 0.000,
        -5.800, 0.800, 0.000)

  wings(Left)

```

```
wings(Right)

writef("// Wheel strut left*n")
rgb(80,80,80)
strut(-0.768, 1.000, -2.000,
      -0.068, 2.000, -3.800)

writef(" // Wheel strut diag left*n")
rgb(80,80,80)
strut( 1.600, 1.000, -2.000,
      -0.168, 2.000, -3.800)

writef("// Wheel strut centre left*n")
rgb(80,80,80)
strut(-0.500, 0.000, -2.900,
      -0.168, 2.000, -3.800)

writef("// Wheel strut right*n")
rgb(80,80,80)
strut(-0.768, -1.000, -2.000,
      -0.068, -2.000, -3.800)

writef("// Wheel strut diag right*n")
rgb(80,80,80)
strut( 1.600, -1.000, -2.000,
      -0.168, -2.000, -3.800)

writef("// Wheel strut centre right*n")
rgb(80,80,80)
strut(-0.500, -0.000, -2.900,
      -0.168, -2.000, -3.800)

writef("// Right wheel*n")
wheel(-0.268, -2.265, -3.800)
writef("// Left wheel*n")
wheel(-0.268, +2.265, -3.800)

fueltank()

writef("// Fuselage*n")

writef("// Prop shaft*n")
rgb(40,40,50)
triangle( 5.500, 0.000, 0.000,
          4.700, 0.200, 0.300,
```

```
        4.700, 0.200, -0.300)
rgb(60,60,40)
triangle( 5.500, 0.000,  0.000,
        4.700, 0.200, -0.300,
        4.700,-0.200, -0.300)
rgb(40,40,50)
triangle( 5.500, 0.000,  0.000,
        4.700,-0.200, -0.300,
        4.700,-0.200,  0.300)
rgb(60,60,40)
triangle( 5.500, 0.000,  0.000,
        4.700,-0.200,  0.300,
        4.700, 0.200,  0.300)

writef("// Engine front lower centre*n")
rgb(140,140,160)
triangle( 5.000, 0.000,  0.000,
        4.500, 0.350, -1.750,
        4.500,-0.350, -1.750)

writef("// Engine front lower left*n")
rgb(140,120,130)
triangle( 5.000, 0.000,  0.000,
        4.500, 0.350, -1.750,
        4.500, 0.550,  0.000)

writef("// Engine front lower right*n")
rgb(140,120,130)
triangle( 5.000, 0.000,  0.000,
        4.500,-0.350, -1.750,
        4.500,-0.550,  0.000)

writef("// Engine front upper centre*n")
rgb(140,140,160)
triangle( 5.000, 0.000,  0.000,
        4.500, 0.350,  0.500,
        4.500,-0.350,  0.500)

writef("// Engine front upper left and right*n")
rgb(100,140,130)
triangle( 5.000, 0.000,  0.000,
        4.500, 0.350,  0.500,
        4.500, 0.550,  0.000)
triangle( 5.000, 0.000,  0.000,
        4.500,-0.350,  0.500,
```

```
4.500,-0.550, 0.000)
```

```
writef("// Engine left lower*n")
rgb(80,80,60)
quad( 1.033, 1.000, 0.000,
      1.800, 1.000, -2.000,
      4.500, 0.350, -1.750,
      4.500, 0.550, 0.000)
```

```
writef(" // Engine right lower*n")
rgb(80,100,60)
quad( 1.033,-1.000, 0.000,
      1.800,-1.000, -2.000,
      4.500,-0.350, -1.750,
      4.500,-0.550, 0.000)
```

```
writef("// Engine top left*n")
rgb(100,130,60)
quad( 1.033, 0.750, 0.950,
      1.033, 1.000, 0.000,
      4.500, 0.550, 0.000,
      4.500, 0.350, 0.500)
```

```
writef("// Engine top centre*n")
rgb(130,160,90)
quad( 1.033, 0.750, 0.950,
      1.033,-0.750, 0.950,
      4.500,-0.350, 0.500,
      4.500, 0.350, 0.500)
```

```
writef("// Engine top right*n")
rgb(100,130,60)
quad( 1.033,-0.750, 0.950,
      1.033,-1.000, 0.000,
      4.500,-0.550, 0.000,
      4.500,-0.350, 0.500)
```

```
writef("// Engine bottom*n")
rgb(100,80,50)
quad( 4.500, 0.350, -1.750,
      4.500,-0.350, -1.750,
      1.800,-1.000, -2.000,
      1.800, 1.000, -2.000)
```



```
writeln("// Front cockpit left*n")
rgb(120,140,60)
quad( -2.000, 1.000, 0.000,
      -2.000, 0.853, 0.600,
      -3.300, 0.853, 0.600,
      -3.300, 1.000, 0.000)

writeln(" // Front cockpit right*n")
rgb(120,140,60)
quad( -2.000,-1.000, 0.000,
      -2.000,-0.853, 0.600,
      -3.300,-0.853, 0.600,
      -3.300,-1.000, 0.000)

writeln("// Top front left*n")
rgb(100,120,40)
quad( 1.033, 0.750, 0.950,
      -2.000, 0.750, 1.000,
      -2.000, 1.000, 0.000,
      1.033, 1.000, 0.000)

writeln("// Top front middle*n")
rgb(120,140,60)
quad( 1.033, 0.750, 0.950,
      1.033,-0.750, 0.950,
      -2.000,-0.750, 1.000,
      -2.000, 0.750, 1.000)

writeln("// Top front right*n")
rgb(100,120,40)
quad( 1.033,-0.750, 0.950,
      -2.000,-0.750, 1.000,
      -2.000,-1.000, 0.000,
      1.033,-1.000, 0.000)

writeln(" // Front wind shield*n")
rgb(180,200,150)
quad( -1.300, 0.450, 1.000, // Centre
      -2.000, 0.450, 1.400,
      -2.000,-0.450, 1.400,
      -1.300,-0.450, 1.000)
rgb(220,220,180)
triangle( -1.300, 0.450, 1.000, // Left
          -2.000, 0.450, 1.400,
```

```

        -2.000, 0.650,  1.000)
triangle( -1.300,-0.450,  1.000, // Right
        -2.000,-0.450,  1.400,
        -2.000,-0.650,  1.000)

writef("// Top left middle*n")
rgb(120,165,90)
quad( -3.300, 0.750,  1.000,
      -3.300, 1.000,  0.000,
      -4.300, 1.000,  0.000,
      -4.300, 0.750,  1.000)

writef("// Top centre middle*n")
rgb(120,140,60)
quad( -3.300, 0.750,  1.000,
      -3.300,-0.750,  1.000,
      -4.300,-0.750,  1.000,
      -4.300, 0.750,  1.000)

writef("// Top right middle*n")
rgb(130,160,90)
quad( -3.300,-0.750,  1.000,
      -3.300,-1.000,  0.000,
      -4.300,-1.000,  0.000,
      -4.300,-0.750,  1.000)

writef("// Rear cockpit left*n")
rgb(120,140,60)
quad( -4.300, 1.000,  0.000,
      -4.300, 0.840,  0.600,
      -5.583, 0.770,  0.600,
      -5.583, 1.000,  0.000)

writef("// Rear wind shield*n")
rgb(180,200,150)
quad( -3.600, 0.450,  1.000, // Centre
      -4.300, 0.450,  1.400,
      -4.300,-0.450,  1.400,
      -3.600,-0.450,  1.000)
rgb(220,220,180)
triangle( -3.600, 0.450,  1.000, // Left
        -4.300, 0.450,  1.400,
        -4.300, 0.650,  1.000)
triangle( -3.600,-0.450,  1.000, // Right

```

```
        -4.300,-0.450,  1.400,
        -4.300,-0.650,  1.000)

writef("// Rear cockpit right*n")
rgb(110,140,70)
quad( -4.300,-1.000,  0.000,
      -4.300,-0.840,  0.600,
      -5.583,-0.770,  0.600,
      -5.583,-1.000,  0.000)
writef("// Lower left middle*n")
rgb(140,110,70)
quad(  1.033,  1.000,  0.000,
      1.800,  1.000, -2.000,
     -3.583,  1.000, -2.238,
     -3.300,  1.000,  0.000)

rgb(155,100,70)
triangle( -3.300,  1.000,  0.000,
         -3.583,  1.000, -2.238,
         -5.583,  1.000,  0.000)

writef("// Bottom middle*n")
rgb(120,100,60)
quad(  1.800,  1.000, -2.000,
     -3.583,  1.000, -2.238,
     -3.583,-1.000, -2.238,
      1.800,-1.000, -2.000)

writef(" // Lower right middle*n")
rgb(140,100,70)
quad(  1.033,-1.000,  0.000,
      1.800,-1.000, -2.000,
     -3.583,-1.000, -2.238,
     -3.300,-1.000,  0.000)

rgb(120,100,70)
triangle( -3.300,-1.000,  0.000,
         -3.583,-1.000, -2.238,
         -5.583,-1.000,  0.000)

writef(" // Lower left back*n")
rgb(165,115,80)
quad( -5.583,  1.000,  0.000,
     -16.000,  0.050,  0.000,
     -16.000,  0.050, -0.667,
```

```

    -3.583, 1.000, -2.238)

writef(" // Bottom back*n")
rgb(130,90,60)
quad( -3.583, 1.000, -2.238,
      -16.000, 0.050, -0.667,
      -16.000,-0.050, -0.667,
      -3.583,-1.000, -2.238)

writef("// Lower right back*n")
rgb(150,140,80)
quad( -5.583,-1.000, 0.000,
      -16.000,-0.050, 0.000,
      -16.000,-0.050, -0.667,
      -3.583,-1.000, -2.238)

writef("// Top left back*n")
rgb(130,125,85)
triangle( -5.583, 0.650, 0.950,
          -5.583, 1.000, 0.000,
          -16.000, 0.050, 0.000)

writef("// Top centre back*n")
rgb(130,160,90)
quad( -5.583, 0.650, 0.950,
      -5.583,-0.650, 0.950,
      -16.000,-0.050, 0.000,
      -16.000, 0.050, 0.000)

writef("// Top right back*n")
rgb(130,120,80)
triangle( -5.583,-0.650, 0.950,
          -5.583,-1.000, 0.000,
          -16.000,-0.050, 0.000)

writef("// End back*n")
rgb(120,165,95)
quad(-16.000, 0.050, 0.000,
     -16.000,-0.050, 0.000,
     -16.000,-0.050, -0.667,
     -16.000, 0.050, -0.667)

writef("// Fin*n")

rgb(170,180,80)

```

```

quad(-14.000, 0.000, 0.000,      // Fin
     -16.000, 0.050, 0.000,
     -16.000, 0.100, 1.000,
     -15.200, 0.000, 1.000)
quad(-14.000, 0.000, 0.000,      // Fin
     -16.000,-0.050, 0.000,
     -16.000,-0.100, 1.000,
     -15.200, 0.000, 1.000)

rgb(70,120,40)
quadkd(-15.200, 0.000, 1.000, 1.0,-0.800, // Rudder R1 left
       -16.000, 0.100, 1.000, 1.0,-0.100,
       -16.800, 0.000, 3.100, 1.0, 0.800,
       -16.000, 0.000, 2.550, 0.0, 0.000)
quadkd(-15.200, 0.000, 1.000, 1.0,-0.800, // Rudder R1 right
       -16.000,-0.100, 1.000, 1.0,-0.100,
       -16.800, 0.000, 3.100, 1.0, 0.800,
       -16.000, 0.000, 2.550, 0.0, 0.000)

rgb(90,100,50)
trianglekd(-16.000, 0.100, 1.000, 0.0, 0.000,
           -15.200, 0.000, 1.000, 1.0,-0.800,
           -16.000,-0.100, 1.000, 0.0, 0.000)
rgb(70, 80,40)
quadkd(-16.000, 0.100, 1.000, 0.0, 0.000, // Rudder R2 left
       -16.800, 0.000, 3.100, 1.0, 0.800,
       -17.566, 0.000, 2.600, 1.0, 1.566,
       -17.816, 0.000, 1.667, 1.0, 1.816)
quadkd(-16.000,-0.100, 1.000, 0.0, 0.000, // Rudder R2 right
       -16.800, 0.000, 3.100, 1.0, 0.800,
       -17.566, 0.000, 2.600, 1.0, 1.566,
       -17.816, 0.000, 1.667, 1.0, 1.866)
rgb(70,120,40)
quadkd(-16.000, 0.100, 1.000, 0.0, 0.000, // Rudder R3 left
       -17.816, 0.000, 1.667, 1.0, 1.816,
       -17.816, 0.000, 1.000, 1.0, 1.816,
       -17.566, 0.000, 0.000, 1.0, 1.566)
quadkd(-16.000,-0.100, 1.000, 0.0, 0.000, // Rudder R3 right
       -17.816, 0.000, 1.667, 1.0, 1.816,
       -17.816, 0.000, 1.000, 1.0, 1.816,
       -17.566, 0.000, 0.000, 1.0, 1.566)
rgb(70, 80,40)
quadkd(-16.000, 0.100, 1.000, 0.0, 0.000, // Rudder R4 left
       -17.566, 0.000, 0.000, 1.0, 1.566,
       -17.000, 0.000,-0.583, 1.0, 1.000,

```

```

        -16.000, 0.000,-0.667, 0.0, 0.000)
quadkd(-16.000,-0.100, 1.000, 0.0, 0.000, // Rudder R5 right
        -17.566, 0.000, 0.000, 1.0, 1.566,
        -17.000, 0.000,-0.583, 1.0, 1.000,
        -16.000, 0.000,-0.667, 0.0, 0.000)

writef("// Tail skid*n")
rgb(40, 40, 40)
quadkd(-16.000, -0.050, -0.667, 0.0, 0.000,
        -16.000, 0.000, -0.627, 0.0, 0.000,
        -16.500, 0.000, -0.860, 1.0, 0.500,
        -16.500, -0.050, -0.900, 1.0, 0.500)
rgb(70, 70, 70)
quadkd(-16.000, 0.050, -0.667, 0.0, 0.000,
        -16.000, 0.000, -0.627, 0.0, 0.000,
        -16.500, 0.000, -0.860, 1.0, 0.500,
        -16.500, 0.050, -0.900, 1.0, 0.500)

rgb(50, 60, 50)
trianglekd(-16.500, 0.050, -0.900, 1.0, 0.500,
           -16.500, 0.000, -0.860, 1.0, 0.500,
           -16.700, 0.050, -0.900, 1.0, 0.700)
rgb(30, 50, 40)
trianglekd(-16.500, -0.050, -0.900, 1.0, 0.500,
           -16.500, 0.000, -0.860, 1.0, 0.500,
           -16.700, -0.050, -0.900, 1.0, 0.700)
rgb(30, 30, 30)
trianglekd(-16.700, -0.050, -0.900, 1.0, 0.700,
           -16.500, 0.000, -0.860, 1.0, 0.500,
           -16.700, 0.050, -0.900, 1.0, 0.700)

writef("// Tailplane and elevator*n")

rgb(120,180,50)
triangle(-16.000, 0.000, 0.100,
         -13.900, 0.600, 0.000,
         -13.900,-0.600, 0.000)
triangle(-16.000, 0.000,-0.100,
         -13.900, 0.600, 0.000,
         -13.900,-0.600, 0.000)

rgb(120,200,50)
quad(-16.000, 2.800, 0.100, // Left tailplane upper
     -13.900, 0.600, 0.000,
     -14.600, 2.800, 0.000,
```

```
        -16.000, 4.500, 0.000)
rgb(120,180,50)
triangle(-16.000, 0.000, 0.100,
         -13.900, 0.600, 0.000,
         -16.000, 2.800, 0.100)
rgb(100,200,50)
quad(-16.000, 2.800,-0.100, // Left tailplane lower
     -13.900, 0.600, 0.000,
     -14.600, 2.800, 0.000,
     -16.000, 4.500, 0.000)
rgb(120,200,70)
triangle(-16.000, 0.000,-0.100,
         -13.900, 0.600, 0.000,
         -16.000, 2.800,-0.100)

rgb(120,200,50)
quad(-16.000,-2.800, 0.100, // Right tailplane upper
     -13.900,-0.600, 0.000,
     -14.600,-2.800, 0.000,
     -16.000,-4.500, 0.000)
rgb(120,180,50)
triangle(-16.000, 0.000, 0.100,
         -13.900,-0.600, 0.000,
         -16.000,-2.800, 0.100)
rgb(100,200,50)
quad(-16.000,-2.800,-0.100, // Right tailplane lower
     -13.900,-0.600, 0.000,
     -14.600,-2.800, 0.000,
     -16.000,-4.500, 0.000)
rgb(120,200,70)
triangle(-16.000, 0.000,-0.100,
         -13.900,-0.600, 0.000,
         -16.000,-2.800,-0.100)

rgb(165,100,50)
quadkd(-16.000, 0.000, 0.100, 0.0, 0.000, // Left elevator
       -17.200, 0.600, 0.000, 2.0, 1.200, // pt 1
       -17.500, 0.900, 0.000, 2.0, 1.500, // pt 2
       -16.000, 2.800, 0.100, 0.0, 0.000)
quadkd(-16.000, 0.000,-0.100, 0.0, 0.000, // Left elevator
       -17.200, 0.600, 0.000, 2.0, 1.200, // pt 1
       -17.500, 0.900, 0.000, 2.0, 1.500, // pt 2
       -16.000, 2.800,-0.100, 0.0, 0.000)

rgb(150,140,100)
```

```

trianglekd(-16.000, 0.000, -0.100, 0.0, 0.000,
           -17.200, 0.600, 0.000, 2.0, 1.200,
           -16.000, 0.000, 0.100, 0.0, 0.000)

rgb(170,150,80)
quadkd(-16.000, 2.800, 0.100, 0.0, 0.000, // Left elevator
       -17.500, 0.900, 0.000, 2.0, 1.500, // pt 2
       -17.666, 2.000, 0.000, 2.0, 1.666, // pt 3
       -17.650, 3.500, 0.000, 2.0, 1.650) // pt 4
quadkd(-16.000, 2.800,-0.100, 0.0, 0.000, // Left elevator
       -17.500, 0.900, 0.000, 2.0, 1.500, // pt 2
       -17.666, 2.000, 0.000, 2.0, 1.666, // pt 3
       -17.650, 3.500, 0.000, 2.0, 1.650) // pt 4

rgb(120,170,60)
quadkd(-16.000, 2.800, 0.100, 0.0, 0.000, // Left elevator
       -17.650, 3.500, 0.000, 2.0, 1.650, // pt 4
       -17.200, 4.650, 0.000, 2.0, 1.200, // pt 5
       -16.700, 4.833, 0.000, 2.0, 0.700) // pt 6
quadkd(-16.000, 2.800,-0.100, 0.0, 0.000, // Left elevator
       -17.650, 3.500, 0.000, 2.0, 1.650, // pt 4
       -17.200, 4.650, 0.000, 2.0, 1.200, // pt 5
       -16.700, 4.833, 0.000, 2.0, 0.700) // pt 6

rgb(160,120,40)
quadkd(-16.000, 2.800, 0.100, 0.0, 0.000, // Left elevator
       -16.700, 4.833, 0.000, 2.0, 0.700, // pt 6
       -16.300, 4.750, 0.000, 2.0, 0.300, // pt 7
       -16.000, 4.500, 0.000, 0.0, 0.000) // pt 8
quadkd(-16.000, 2.800,-0.100, 0.0, 0.000, // Left elevator
       -16.700, 4.833, 0.000, 2.0, 0.700, // pt 6
       -16.300, 4.750, 0.000, 2.0, 0.300, // pt 7
       -16.000, 4.500, 0.000, 0.0, 0.000) // pt 8

rgb(165,100,50)
quadkd(-16.000, 0.000, 0.100, 0.0, 0.000, // Right elevator
       -17.200,-0.600, 0.000, 2.0, 1.200, // pt 1
       -17.500,-0.900, 0.000, 2.0, 1.500, // pt 2
       -16.000,-2.800, 0.100, 0.0, 0.000)
quadkd(-16.000, 0.000,-0.100, 0.0, 0.000, // Right elevator
       -17.200,-0.600, 0.000, 2.0, 1.200, // pt 1
       -17.500,-0.900, 0.000, 2.0, 1.500, // pt 2
       -16.000,-2.800,-0.100, 0.0, 0.000)

rgb(140,130,90)

```



```

trianglekd(-16.000, 0.000, -0.100, 0.0, 0.000,
           -17.200,-0.600,  0.000, 2.0, 1.200,
           -16.000, 0.000,  0.100, 0.0, 0.000)

rgb(170,150,80)
quadkd(-16.000,-2.800, 0.100, 0.0, 0.000, // Right elevator
       -17.500,-0.900, 0.000, 2.0, 1.500, // pt 2
       -17.666,-2.000, 0.000, 2.0, 1.666, // pt 3
       -17.650,-3.500, 0.000, 2.0, 1.650) // pt 4
quadkd(-16.000,-2.800,-0.100, 0.0, 0.000, // Right elevator
       -17.500,-0.900, 0.000, 2.0, 1.500, // pt 2
       -17.666,-2.000, 0.000, 2.0, 1.666, // pt 3
       -17.650,-3.500, 0.000, 2.0, 1.650) // pt 4

rgb(120,170,60)
quadkd(-16.000,-2.800, 0.100, 0.0, 0.000, // Right elevator
       -17.650,-3.500, 0.000, 2.0, 1.650, // pt 4
       -17.200,-4.650, 0.000, 2.0, 1.200, // pt 5
       -16.700,-4.833, 0.000, 2.0, 0.700) // pt 6
quadkd(-16.000,-2.800,-0.100, 0.0, 0.000, // Right elevator
       -17.650,-3.500, 0.000, 2.0, 1.650, // pt 4
       -17.200,-4.650, 0.000, 2.0, 1.200, // pt 5
       -16.700,-4.833, 0.000, 2.0, 0.700) // pt 6

rgb(160,120,40)
quadkd(-16.000,-2.800, 0.100, 0.0, 0.000, // Right elevator
       -16.700,-4.833, 0.000, 2.0, 0.700, // pt 6
       -16.300,-4.750, 0.000, 2.0, 0.300, // pt 7
       -16.000,-4.500, 0.000, 2.0, 0.000) // pt 8
quadkd(-16.000,-2.800,-0.100, 0.0, 0.000, // Right elevator
       -16.700,-4.833, 0.000, 2.0, 0.700, // pt 6
       -16.300,-4.750, 0.000, 2.0, 0.300, // pt 7
       -16.000,-4.500, 0.000, 0.0, 0.000) // pt 8

rgb(165,100,50)
quadkd(-16.000, 0.000, 0.100, 0.0, 0.000, // Right elevator
       -17.200,-0.600, 0.000, 2.0, 1.200, // pt 1
       -17.500,-0.900, 0.000, 2.0, 1.500, // pt 2
       -16.000,-2.800, 0.100, 0, 0.000)
quadkd(-16.000, 0.000,-0.100, 0.0, 0.000, // Right elevator
       -17.200,-0.600, 0.000, 2.0, 1.200, // pt 1
       -17.500,-0.900, 0.000, 2.0, 1.500, // pt 2
       -16.000,-2.800,-0.100, 0.0, 0.000)

```

```
/*
```

```

// Construct the landscape and runway
writef("// Runway*n")

{ MANIFEST { ns = 50.000
            ws = 5.000
            }
  FOR n = 0 TO 600.000-ns BY ns DO
    FOR w = -20.000 TO 20.000-ws BY ws DO
      { LET m = (17*n XOR 5*w)>>1
        LET r = 150 + m MOD 23
        LET g = 160 + m MOD 13
        LET b = 170 + m MOD 37
        quadland( n,      w, 1.000, r,  g, b,
                  n,      w+ws, 1.000, r,  g, b,
                  n+ns, w+ws, 1.000, r,  g, b,
                  n+ns,   w, 1.000, r,  g, b)
      }
    }
  writef("// The land*n")
  // Plot a square region of land
  plotland(-5.000.000, -5.000.000, 10.000.000)
*/

fin:
  writef("ds 3*n")           // Only one display item.
  writef("d 5 %n 0*n", indexcount) // Draw 21 (=63/3) triangle stating at index zero.
  writef("z*n")

  newline()
  sawritef("// vs %i5 // %n vertices*n", 8*vertexcount, vertexcount)
  sawritef("// is %i5*n", indexcount)
}

AND wings(FLT side) BE
{ // side=1.0 for left wings and -1.0 for right wings

  writef("// Lower wing*n")
  rgb(165,165,30) // Under surface
  quad(-0.500, side*1.000, -2.000, // Panel A
        -3.767, side*1.000, -2.218,
        -4.396, side*6.000, -1.745,
        -1.129, side*6.000, -1.527)

  rgb(155,150,40)
  quad(-3.767, side*1.000, -2.218, // Panel B

```

```
-4.917, side*1.000, -2.294,  
-5.546, side*6.000, -1.821,  
-4.396, side*6.000, -1.745)  
  
rgb(160,165,50)  
quad(-1.129, side*6.000, -1.527, // Panel C  
      -4.396, side*6.000, -1.745,  
      -5.147,side*14.166, -1.179,  
      -1.880,side*14.166, -0.961)  
  
rgb(155,155,20) // Under surface  
quadkd(-4.396, side*6.000, -1.745, 0.0, 0.000, // Panel D Aileron  
        -5.546, side*6.000, -1.821, 4.0, 1.150,  
        -6.297,side*13.766, -1.255, 4.0, 1.150,  
        -5.147,side*14.166, -1.179, 0.0, 0.000)  
  
writef("// Lower wing upper surface*n")  
rgb(120,140,60)  
  
quad(-0.500, side*1.000, -2.000, // Panel A1  
      -1.500, side*1.000, -1.800,  
      -2.129, side*6.000, -1.327,  
      -1.129, side*6.000, -1.527)  
  
rgb(120,130,50)  
quad(-1.500, side*1.000, -1.800, // Panel A2  
      -3.767, side*1.000, -2.118,  
      -4.396, side*6.000, -1.645,  
      -2.129, side*6.000, -1.327)  
  
rgb(110,140,50)  
quad(-3.767, side*1.000, -2.118, // Panel B  
      -4.917, side*1.000, -2.294,  
      -5.546, side*6.000, -1.821,  
      -4.396, side*6.000, -1.645)  
  
rgb(120,140,60)  
quad(-1.129, side*6.000, -1.527, // Panel C1  
      -2.129, side*6.000, -1.327,  
      -2.880,side*14.166, -0.761,  
      -1.880,side*14.166, -0.961)  
  
rgb(120,130,50)  
quad(-2.129, side*6.000, -1.327, // Panel C2  
      -4.396, side*6.000, -1.645,
```

```

    -5.147,side*14.166, -1.079,
    -2.880,side*14.166, -0.761)

rgb(110,140,40)
triangle(-3.767, side*1.000, -2.118, // Gusset low wing root
        -4.917, side*1.000, -2.294,
        -3.767, side*1.000, -2.218)

rgb(120,140,60)
quadkd(-4.396, side*6.000, -1.645, 0.0, 0.000, // Panel D Aileron
       -5.546, side*6.000, -1.821, 4.0, 1.150,
       -6.297,side*13.766, -1.255, 4.0, 1.150,
       -5.147,side*14.166, -1.079, 0.0, 0.000)

rgb(120,130,70)
trianglekd(-4.396, side*6.000, -1.745, 0.0, 0.000, // Aileron fixed end
         -5.546, side*6.000, -1.821, 0.0, 0.000,
         -4.396, side*6.000, -1.645, 0.0, 0.000)

rgb(110,120,50)
trianglekd(-4.396, side*6.000, -1.745, 0.0, 0.000, // Aileron near end
         -5.546, side*6.000, -1.821, 4.0, 1.150,
         -4.396, side*6.000, -1.645, 0.0, 0.000)

rgb(100,140,60)
trianglekd(-5.147, side*14.166, -1.079, 0.0, 0.000, // Aileron tip end
         -6.297, side*13.766, -1.255, 4.0, 1.150,
         -5.147, side*14.166, -1.179, 0.0, 0.000)

    writef("// Lower wing tip*n")
rgb(130,150,60)
triangle(-1.880,side*14.167,-0.961,//-1.006, // T1
        -2.880,side*14.167,-0.761,
        -3.880,side*14.467,-0.980)
rgb(130,150,60)
triangle(-2.880,side*14.167,-0.761,
        -5.147,side*14.167,-1.079,
        -3.880,side*14.467,-0.980)
rgb(160,160,40)
triangle(-5.147,side*14.167,-1.079,
        -5.147,side*14.167,-1.179,
        -3.880,side*14.467,-0.980)
rgb(170,170,50)
triangle(-5.147,side*14.167,-1.179,
        -1.880,side*14.167,-0.961,

```

```

        -3.880,side*14.467,-0.980)

writef("// Upper wing*n")
rgb(200,200,30)          // Under surface
quad( 1.333, side*1.000,  2.900,
      -1.967, side*1.000,  2.671,
      -3.297,side*14.167,  3.671,
       0.003,side*14.167,  3.894)
rgb(190,210,40)
quad(-1.967, side*1.000,  2.671,
      -3.084, side*2.200,  2.606,
      -4.414,side*13.767,  3.645,
      -3.297,side*14.167,  3.671)

rgb(150,170,90)        // Top surface
quad( 1.333, side*1.000,  2.900, // Panel A1
      0.333, side*1.000,  3.100,
      -0.997,side*14.167,  4.094,
       0.003,side*14.167,  3.894)

rgb(140,160,80)        // Top surface
quad( 0.333, side*1.000,  3.100, // Panel A2
      -1.967, side*1.000,  2.771,
      -3.297,side*14.167,  3.771,
      -0.997,side*14.167,  4.094)

rgb(150,170,90)        // Top surface
quad(-1.967, side*1.000,  2.771, // Panel B
      -3.084, side*2.200,  2.606,
      -4.414,side*13.767,  3.645,
      -3.297,side*14.167,  3.771)

rgb(140,180,100)
triangle(-1.967, side*1.000,  2.771, // Top right wing root gusset
        -3.084, side*2.200,  2.606,
        -1.967, side*1.000,  2.671)

writef("// Right upper wing tip*n")
rgb(130,150,60)
triangle( 0.003,side*14.167,  3.894,
        -0.997,side*14.167,  4.094,
        -1.997,side*14.467,  3.874)
rgb(130,150,60)
triangle(-0.997,side*14.167,  4.094,
        -3.297,side*14.167,  3.771,

```

```

        -1.997,side*14.467, 3.874)
rgb(160,160,40)
triangle(-3.297,side*14.167, 3.771,
        -3.297,side*14.167, 3.671,
        -1.997,side*14.467, 3.874)
rgb(170,170,50)
triangle(-3.297,side*14.167, 3.671,
        0.003,side*14.167, 3.894,
        -1.997,side*14.467, 3.874)

writef("// Wing root strut forward right*n")
rgb(80,80,80)
strut(0.433, side*0.950, 2.900,
      0.433, side*1.000, 0.000)

writef(" // Wing root strut rear right*n")
rgb(80,80,80)
strut(-1.967, side*0.950, 2.671,
      -1.068, side*1.000, 0.000)

writef("// Wing root strut diag right*n")
rgb(80,80,80)
strut( 0.433, side*0.950, 2.900,
      -1.068, side*1.000, 0.000)

writef("// Wing strut forward right*n")
rgb(80,80,80)
strut(-2.200, side*10.000, -1.120,
      -0.300, side*10.000, 3.445)

writef("// Wing strut rear right*n")
rgb(80,80,80)
strut(-4.500, side*10.000, -1.260,
      -2.500, side*10.000, 3.410)
}

AND fueltank() BE
{ LET FLT ft1, FLT fl1 = 1.333, 2.900
  LET FLT ft2, FLT fl2 = 1.100, 3.180
  LET FLT ft3, FLT fl3 = 0.500, 3.400
  LET FLT ft4, FLT fl4 = -0.700, 3.210
  LET FLT ft5, FLT fl5 = -1.967, 2.771
  LET FLT ft6, FLT fl6 = -1.967, 2.671
  LET FLT ft7, FLT fl7 = -0.700, 2.600

```

```
LET FLT ft8, FLT f18 = 0.500, 2.700

writef("// Fueltank top forward*n")
rgb(200,200,230)
quad( 1.333, 1.000, f11, // Top forward
      1.333, -1.000, f11,
      1.100, -1.000, f12,
      1.100, 1.000, f12)

writef("// Fueltank top middle forward*n")
rgb(190,200,220)
quad( 1.100, -1.000, f12, // Top middle forward
      1.100, 1.000, f12,
      0.500, 1.000, f13,
      0.500, -1.000, f13)

writef("// Fueltank top middle rear*n")
rgb(200,200,220)
quad( 0.500, 1.000, f13, // Top middle rear
      0.500, -1.000, f13,
      -0.700, -1.000, f14,
      -0.700, 1.000, f14)

writef("// Fueltank top back*n")
rgb(190,190,210)
quad(ft4, -1.000, f14, // Top back
      ft4, 1.000, f14,
      ft5, 1.000, f15,
      ft5, -1.000, f15)

writef("// Fueltank back*n")
rgb(210,220,240)
quad(ft5, -1.000, f15, // Under back
      ft5, 1.000, f15,
      ft6, 1.000, f16,
      ft6, -1.000, f16)

writef("// Fueltank under rear*n")
rgb(180,200,200)
quad(ft6, -1.000, f16, // Under back
      ft6, 1.000, f16,
      ft7, 1.000, f17,
      ft7, -1.000, f17)
```

```

writef("// Fueltank under middle*n")
rgb(170,190,190)
quad(ft7, -1.000, f17, // Under middle
      ft7,  1.000, f17,
      ft8,  1.000, f18,
      ft8, -1.000, f18)

writef("// Fueltank under front*n")
rgb(200,210,220)
quad(ft8, -1.000, f18, // Under front
      ft8,  1.000, f18,
      ft1,  1.000, f11,
      ft1, -1.000, f11)

writef("// Fueltank back*n")
rgb(220,190,250)
quad(ft5, -1.000, f15, // back
      ft5,  1.000, f15,
      ft6,  1.000, f16,
      ft6, -1.000, f16)

writef("// Fueltank left side*n")
rgb(200,220,230)
quad(ft1,  1.000, f11, // Forward
      ft2,  1.000, f12,
      ft3,  1.000, f13,
      ft8,  1.000, f18)
rgb(215,235,200)
quad(ft3,  1.000, f13, // Middle
      ft4,  1.000, f14,
      ft7,  1.000, f17,
      ft8,  1.000, f18)
rgb(210,220,240)
quad(ft4,  1.000, f14, // Rear
      ft5,  1.000, f15,
      ft6,  1.000, f16,
      ft7,  1.000, f17)

writef("// Fueltank right side*n")
rgb(200,220,230)
quad( 1.333, -1.000, f11, // Forward
      1.100, -1.000, f12,
      0.500, -1.000, f13,
      0.500, -1.000, f18)

```



```

rgb(215,235,200)
  quad( 0.500, -1.000, f13,  // Middle
        -0.700, -1.000, f14,
        -0.700, -1.000, f17,
        0.500, -1.000, f18)
rgb(210,220,240)
  quad(ft4, -1.000, f14,  // Rear
        ft5, -1.000, f15,
        ft6, -1.000, f16,
        ft7, -1.000, f17)
}

AND wheel(tpos, wpos, lpos) BE
{ rgb(60,20,20)
  //      t          w          l
  quad( tpos,      wpos+0.200, lpos,      // top back left
        tpos-0.500, wpos+0.250, lpos,
        tpos-0.350, wpos+0.250, lpos+0.350,
        tpos,      wpos+0.250, lpos+0.500)
  quad( tpos-0.500, wpos+0.250, lpos,
        tpos-0.650, wpos      , lpos,
        tpos-0.500, wpos,      lpos+0.500,
        tpos-0.350, wpos+0.250, lpos+0.350)
  quad( tpos-0.350, wpos+0.250, lpos+0.350,
        tpos-0.500, wpos      , lpos+0.500,
        tpos      , wpos,      lpos+0.650,
        tpos,      wpos+0.250, lpos+0.500)

  quad( tpos,      wpos-0.200, lpos,      // top back right
        tpos-0.500, wpos-0.250, lpos,
        tpos-0.350, wpos-0.250, lpos+0.350,
        tpos,      wpos-0.250, lpos+0.500)
  quad( tpos-0.500, wpos-0.250, lpos,
        tpos-0.650, wpos      , lpos,
        tpos-0.500, wpos,      lpos+0.500,
        tpos-0.350, wpos-0.250, lpos+0.350)
  quad( tpos-0.350, wpos-0.250, lpos+0.350,
        tpos-0.500, wpos      , lpos+0.500,
        tpos      , wpos,      lpos+0.650,
        tpos,      wpos-0.250, lpos+0.500)

  quad( tpos,      wpos+0.200, lpos,      // top front left
        tpos+0.500, wpos+0.250, lpos,
        tpos+0.350, wpos+0.250, lpos+0.350,
        tpos,      wpos+0.250, lpos+0.500)
}

```

```

quad( tpos+0.500, wpos+0.250, lpos,
      tpos+0.650, wpos      , lpos,
      tpos+0.500, wpos      , lpos+0.500,
      tpos+0.350, wpos+0.250, lpos+0.350)
quad( tpos+0.350, wpos+0.250, lpos+0.350,
      tpos+0.500, wpos      , lpos+0.500,
      tpos      , wpos      , lpos+0.650,
      tpos      , wpos+0.250, lpos+0.500)

quad( tpos,      wpos-0.200, lpos,      // top front right
      tpos+0.500, wpos-0.250, lpos,
      tpos+0.350, wpos-0.250, lpos+0.350,
      tpos,      wpos-0.250, lpos+0.500)
quad( tpos+0.500, wpos-0.250, lpos,
      tpos+0.650, wpos      , lpos,
      tpos+0.500, wpos      , lpos+0.500,
      tpos+0.350, wpos-0.250, lpos+0.350)
quad( tpos+0.350, wpos-0.250, lpos+0.350,
      tpos+0.500, wpos      , lpos+0.500,
      tpos      , wpos      , lpos+0.650,
      tpos      , wpos-0.250, lpos+0.500)

quad( tpos,      wpos+0.200, lpos,      // bottom back left
      tpos-0.500, wpos+0.250, lpos,
      tpos-0.350, wpos+0.250, lpos-0.350,
      tpos,      wpos+0.250, lpos-0.500)
quad( tpos-0.500, wpos+0.250, lpos,
      tpos-0.650, wpos      , lpos,
      tpos-0.500, wpos      , lpos-0.500,
      tpos-0.350, wpos+0.250, lpos-0.350)
quad( tpos-0.350, wpos+0.250, lpos-0.350,
      tpos-0.500, wpos      , lpos-0.500,
      tpos      , wpos      , lpos-0.650,
      tpos      , wpos+0.250, lpos-0.500)

quad( tpos,      wpos-0.200, lpos,      // bottom back right
      tpos-0.500, wpos-0.250, lpos,
      tpos-0.350, wpos-0.250, lpos-0.350,
      tpos,      wpos-0.250, lpos-0.500)
quad( tpos-0.500, wpos-0.250, lpos,
      tpos-0.650, wpos      , lpos,
      tpos-0.500, wpos      , lpos-0.500,
      tpos-0.350, wpos-0.250, lpos-0.350)
quad( tpos-0.350, wpos-0.250, lpos-0.350,

```

```

        tpos-0.500, wpos      , lpos-0.500,
        tpos      , wpos,      lpos-0.650,
        tpos,      wpos-0.250, lpos-0.500)

quad( tpos,      wpos+0.200, lpos,      // bottom front left
      tpos+0.500, wpos+0.250, lpos,
      tpos+0.350, wpos+0.250, lpos-0.350,
      tpos,      wpos+0.250, lpos-0.500)
quad( tpos+0.500, wpos+0.250, lpos,
      tpos+0.650, wpos      , lpos,
      tpos+0.500, wpos,      lpos-0.500,
      tpos+0.350, wpos+0.250, lpos-0.350)
quad( tpos+0.350, wpos+0.250, lpos-0.350,
      tpos+0.500, wpos      , lpos-0.500,
      tpos      , wpos,      lpos-0.650,
      tpos,      wpos+0.250, lpos-0.500)

quad( tpos,      wpos-0.200, lpos,      // bottom front right
      tpos+0.500, wpos-0.250, lpos,
      tpos+0.350, wpos-0.250, lpos-0.350,
      tpos,      wpos-0.250, lpos-0.500)
quad( tpos+0.500, wpos-0.250, lpos,
      tpos+0.650, wpos      , lpos,
      tpos+0.500, wpos,      lpos-0.500,
      tpos+0.350, wpos-0.250, lpos-0.350)
quad( tpos+0.350, wpos-0.250, lpos-0.350,
      tpos+0.500, wpos      , lpos-0.500,
      tpos      , wpos,      lpos-0.650,
      tpos,      wpos-0.250, lpos-0.500)
}

AND strut(FLT t1, FLT w1, FLT l1, FLT t4, FLT w4, FLT l4) BE
{ LET FLT t2 = (3*t1+t4)/4
  LET FLT w2 = (3*w1+w4)/4
  LET FLT l2 = (3*l1+l4)/4
  LET FLT t3 = (3*t4+t1)/4
  LET FLT w3 = (3*w4+w1)/4
  LET FLT l3 = (3*l4+l1)/4
  LET FLT ta, FLT wa = 0.050, 0.030
  LET FLT tb, FLT wb = 0.110, 0.050

  rgb(80,80,80)
  quad(t1-ta,w1,l1, t1,w1+wa,l1, t2,w2+wb,l2, t2-tb,w2,l2)
  rgb(85,75,80)
  quad(t1-ta,w1,l1, t1,w1-wa,l1, t2,w2-wb,l2, t2-tb,w2,l2)

```

```

    rgb(85,80,85)
    quad(t1,w1+wa,l1, t1+ta,w1,l1, t2+tb,w2,l2, t2,w2+wb,l2)
    rgb(75,80,80)
    quad(t1,w1-wa,l1, t1+ta,w1,l1, t2+tb,w2,l2, t2,w2-wb,l2)

    rgb(90,80,80)
    quad(t2-tb,w2,l2, t2,w2+wb,l2, t3,w3+wb,l3, t3-tb,w3,l3)
    rgb(95,75,80)
    quad(t2,w2+wb,l2, t2+tb,w2,l2, t3+tb,w3,l3, t3,w3+wb,l3)
    rgb(90,85,80)
    quad(t2+tb,w2,l2, t2,w2-wb,l2, t3,w3-wb,l3, t3+tb,w3,l3)
    rgb(80,80,85)
    quad(t2,w2-wb,l2, t2-tb,w2,l2, t3-tb,w3,l3, t3,w3-wb,l3)

    rgb(80,80,80)
    quad(t4-ta,w4,l4, t4,w4+wa,l4, t3,w3+wb,l3, t3-tb,w3,l3)
    rgb(85,75,80)
    quad(t4-ta,w4,l4, t4,w4-wa,l4, t3,w3-wb,l3, t3-tb,w3,l3)
    rgb(85,80,85)
    quad(t4,w4+wa,l4, t4+ta,w4,l4, t3+tb,w3,l3, t3,w3+wb,l3)
    rgb(75,80,80)
    quad(t4,w4-wa,l4, t4+ta,w4,l4, t3+tb,w3,l3, t3,w3-wb,l3)
}

/*
AND height(n, w) = VALOF
{ // Make it zero on or near the runway or more than landsize away
  // from the runway.
  // Make the height small near the runway and typically larger
  // away from the runway, but keep it small near the coast.
  // n is the distance north
  // w is the distance west
  LET halfsize = landsize/2
  LET h = randheight(n, w,
                    -halfsize, +halfsize, // x coords
                    -halfsize, +halfsize, // y coords
                    0, 0, 0, 0) // corner heights
  LET dist = (ABS(n - runwaylength/2)) + (ABS(w))
  // dist is the manhattan distance from the centre of the runway.
  LET factor = ? // Will be in the range 0 to 1.000 depending on dist
  LET d1, d2 = 600.000, 3.000.000
  LET d3 = landsize - dist
  IF dist <= d1 DO factor := 0
  IF dist >= d2 DO factor := 1.000

```

```

    IF d1<dist<d2 DO factor := muldiv(1.000, dist-d1, d2-d1)
    // factor is a function of dist. Below d1 it is zero. Between
    // d1 and d2 it grows linearly to 1.000. Above d2 it remains at 1.000.
//sawritef("dist=%9.3d factor=%6.3d h=%i9*n", dist, factor, h)
    IF d3<=0 RESULTIS 0 // Above the sea
    h := muldiv(h, factor, 1.000) / 1000

    IF d3 < 2.000.000 DO
    { // 0 < d3 < 2.000.000
      // So over land near the coast.
      // Reduce the height appropriately.
      h := muldiv(h, d3, 2.000.000)
    }
//sawritef("h=%i9 h^2=%i9*n", h, h*h)
    RESULTIS (h * h)
}

AND randvalue(x, y, max) = VALOF
{ LET a = 123*x >> 1
  LET b = 541*y >> 3
  LET hashval = ABS((a*b XOR b XOR #x1234567)/3)
  hashval := hashval MOD (max+1)
//sawritef("randvalue: (%i9 %i9 %i9) => %i4*n", x, y, max, hashval)
  RESULTIS hashval
}

AND randheight(x, y, x0, x1, y0, y1, h0, h1, h2, h3) = VALOF
{ // Return a random height depending on x and y only.
  // The result is in the range 0 to 1000
  LET k0, k1, k2, k3 = ?, ?, ?, ?
  LET size = x1-x0
  LET sz = size>1.000.000 -> 1.000.000, size/2
  LET sz2 = sz/2

  TEST sz < 100.000
  THEN { // Use linear interpolation based on the heights
        // of the corners.
        // The formula is
        //      h = a + bp + cq + dpq
        // where a = h0
        //      b = h1 - h0
        //      c = h2 - h0
        //      d = h3 - h2 - h1 + h0
        //      p = (x-x0)/(x1-x0)
        // and   q = (y-y0)/(y1-y0)

```

```

// This formula agrees with the heights at four the vertices,
// and for fixed x it is linear in y, and vice-versa.
LET a = h0
LET b = h1-h0
LET c = h2-h0
LET d = h3-h2-h1+h0
b := muldiv(b, x-x0, x1-x0)
c := muldiv(c, y-y0, y1-y0)
d := muldiv(muldiv(d, x-x0, x1-x0), y-y0, y1-y0)
RESULTIS a+b+c+d
}
ELSE { // Calculate the heights of the vertices of the 1/2 sized square
// containing x,y.
LET mx = (x0+x1)/2
LET my = (y0+y1)/2
LET mh = (h0+h1+h2+h3)/4 + randvalue(mx, my, sz) - sz2
TEST x<mx
THEN TEST y<my
    THEN { // Lower left
        LET k1 = (h0+h1)/2 + randvalue(mx, y0, sz) - sz2
        LET k2 = (h0+h2)/2 + randvalue(x0, my, sz) - sz2
        h1, h2, h3 := k1, k2, mh
        x1, y1 := mx, my
        LOOP
    }
    ELSE { // Upper left
        LET k0 = (h0+h2)/2 + randvalue(x0, my, sz) - sz2
        LET k3 = (h2+h3)/2 + randvalue(mx, y1, sz) - sz2
        h0, h1, h3 := k0, mh, k3
        x1, y0 := mx, my
        LOOP
    }
ELSE TEST y<my
    THEN { // Lower right
        LET k0 = (h0+h1)/2 + randvalue(mx, y0, sz) - sz2
        LET k3 = (h1+h3)/2 + randvalue(x1, my, sz) - sz2
        h0, h2, h3 := k0, mh, k3
        x0, y1 := mx, my
        LOOP
    }
    ELSE { // Upper right
        LET k1 = (h1+h3)/2 + randvalue(x1, my, sz) - sz2
        LET k2 = (h0+h2)/2 + randvalue(mx, y1, sz) - sz2
        h0, h1, h2 := mh, k1, k2
        x0, y0 := mx, my
    }
}

```

```

                                LOOP
                                }
                                }
} REPEAT

AND plotland(n, w, size) BE
{ LET sz = size/80

  // First plot the sea at level 0
  rgb(50, 0, 200) // Rad blue
  //size := 1.000.000
  triangleland(-size, -size, -2000, 50, 0, 200,
               +size, -size, -2000, 50, 0, 200,
               +size, +size, -2000, 50, 0, 200)
  triangleland(-size, -size, -2000, 50, 0, 200,
               +size, +size, -2000, 50, 0, 200,
               +size, +size, -2000, 50, 0, 200)

//RETURN

FOR i = 0 TO 79 DO
{ LET n0 = n + i*sz
  LET n1 = n0 + sz
  FOR j = 0 TO 79 DO
  { LET w0 = w + j*sz
    LET w1 = w0 + sz
    LET h0 = height(n0, w0)
    LET h1 = height(n0, w1)
    LET h2 = height(n1, w1)
    LET h3 = height(n1, w0)
    LET r, g, b = redefn(n0,w0,h0), greenfn(n0,w0,h0), bluefn(n0,w0,h0)
    IF h0<=0 DO r, g, b := 50, 100, 200
  //sawritef("calling qualdland(%n,%n,%n,...)*n", n0, w0, h0)
  //quadland(n0,w0,h0, r, g, b,
  //          n0,w1,h1, r, g, b,
  //          n1,w1,h2, r, g, b,
  //          n1,w0,h3, r, g, b)
  triangleland( n0,w0,h0, r, g, b,
               n0,w1,h1, r, g, b,
               n1,w1,h2, r, g, b)
  triangleland( n0,w0,h0, r XOR 16, g XOR 16, b XOR 16,
               n1,w1,h2, r XOR 16, g XOR 16, b XOR 16,
               n1,w0,h3, r XOR 16, g XOR 16, b XOR 16)

  }
}
}

```

```

    }
}

AND plotland1(x0, y0, sx, sy, h0, h1, h2, h3) BE
{ // This construct a rectangle of land with its south western corner
  // at (x0,y0) using world coordinates. The east-west size of the
  // square is sx, and sy is the north-south size. The vertices are
  // numbered 0 to 3 anticlockwise starting ar (x0,y0).
  LET x2, y2 = x0+sx, y0+sy

  TEST sx > 1000.000
  THEN { FOR i = 0 TO 9 DO
    { LET xa = (x0 * (10-i) + x2 * i ) / 10
      LET xb = (x0 * ( 9-i) + x2 * (i+1)) / 10
      LET sx1 = xb-xa

      LET ha = (h0 * (10-i) + h1 * i ) / 10
      LET hb = (h0 * ( 9-i) + h1 * (i+1)) / 10
      LET hc = (h2 * ( 9-i) + h2 * (i+1)) / 10
      LET hd = (h2 * (10-i) + h3 * i ) / 10

      ha := ha + height(xa, y0, sx1)
      hb := hb + height(xa, y0, sx1)
      hc := hc + height(xb, y2, sx1)
      hd := hd + height(xb, y2, sx1)

      FOR j = 0 TO 9 DO
      { LET ya = (y0 * (10-j) + y2 * j ) / 10
        LET yb = (y0 * ( 9-j) + y2 * (j+1)) / 10
        LET sy1 = yb-ya

        LET ka = (ha * (10-j) + hd * j ) / 10
        LET kb = (hb * ( 9-j) + hc * (j+1)) / 10
        LET kc = (hb * ( 9-j) + hc * (j+1)) / 10
        LET kd = (ha * (10-j) + hd * j ) / 10

        ka := ka + height(xa, ya, sy1)
        kb := kb + height(xb, ya, sy1)
        kc := kc + height(xb, yb, sy1)
        kd := kd + height(xa, yb, sy1)

        plotland(xa, ya, sx1, sy1, ka, kb, kc, kd)
      }
    }
  }
}
}

```



```

ELSE { LET r, g, b = redfn(x0,y0,h0), greenfn(x0,y0,h0), bluefn(x0,y0,h0)
sawritef("calling qualdland(%n,%n,%n,...)*n", x0, y0, h0)
    quadland(x0,y0,h0, r, g, b,
             x0,y2,h1, r, g, b,
             x2,y2,h2, r, g, b,
             x2,y0,h3, r, g, b)
    }
}

AND redfn(x,y,h) = VALOF
{ LET col = 10 + h/3.000 +
  ((x * 12345)>>1) MOD 17 +
  ((y * 23456)>>1) MOD 37 +
  ((h * 34567)>>1) MOD 53
  IF col > 255 DO col := 255
  RESULTIS col
}

AND greenfn(x,y,h) = VALOF
{ LET col = 150 + h/3.000 +
  ((x * 123456)>>1) MOD 17 +
  ((y * 234567)>>1) MOD 37 +
  ((h * 345678)>>1) MOD 53
  IF col > 255 DO col := 255
  RESULTIS col
}

AND bluefn(x,y,h) = VALOF
{ LET col = 20 + h/3.000 +
  ((x * 1234567)>>1) MOD 17 +
  ((y * 2345678)>>1) MOD 37 +
  ((h * 3456789)>>1) MOD 53
  IF col > 255 DO col := 255
  RESULTIS col
}
*/

```

The flight simulator program is currently under development and is called `tiger.b`, it is currently as follows. Currently you cannot fly the tigermoth but just move it and rotate it, and view it from various directions.

```

/*
##### THIS IS UNDER DEVELOPMENT #####

```

This is a flight simulator based on Jumbo that ran interactively on a

PDP 11 generating the pilots view on a Vector General Display.

Originally implemented by Martin Richards in mid 1970s.

Substantially modified by Martin Richards (c) October 2012.

It has been extended to use 32 rather than 16 bit arithmetic.

It is planned that this will simulate the flying characteristics of a De Havilland D.H.82A Tiger Moth which I learnt to fly as a teenager.

Change history

22/03/2018

Made extensive modifications based on the recent changes to draw3d.b.
It now makes use of floating point and the new FLT feature.

25/01/2013

Name changed to tiger.b

Controls

Either use a USB Joystick for elevator, ailerons and throttle, or use the keyboard as follows:

Up arrow	Trim joystick forward a bit
Down arrow	Trim joystick backward a bit
Left arrow	Trim joystick left a bit
Right arrow	Trim joystick right a bit
, or <	Trim rudder left
. or >	Trim rudder right
x	More throttle
z	Less throttle
0	Display the pilot's view
1,2,3,4,5,6,7,8	Display the aircraft viewed from various angles
f	View aircraft from a greater distance
n	View aircraft from a closer position
p	pause/unpause the simulation
g	Reset the aircraft on the glide path

```

t          Reset the aircraft ready for take off -- default
           ie stationary on the ground at the end of the runway

u          Plot usage

a, b, c    Rotate the aircraft anti-clockwise about axes t, w, l
A, B, C    Rotate the aircraft clockwise about axes t, w, l

q          Quit

```

There are joystick buttons equivalent to Up arrow, Down arrow, Left Arrow and Right arrow. There are also joystick buttons to trim the rudder left and right, useful for steering on the runway.

The display shows various beacons on the ground including the lights on the sides and the ends of the runway.

The display also shows various flight instruments including the artificial horizon, the height and speed and various navigational aids to help the pilot find the runway.

```
*/
```

```
GET "libhdr"
```

```
GET "sdl.h"
```

```
GET "sdl.b"
```

```
.
```

```
GET "libhdr"
```

```
GET "sdl.h"
```

```
MANIFEST {
```

```
  FLT D45 = 0.707107 // cosine of pi/4
```

```
  FLT Sps = 20.0     // Steps per second
```

```
  FLT Sps2 = 2 * Sps // Twice steps per second
```

```
  // Most measurements are in feet held as floating point numbers.
```

```
  FLT k_g = 32.0     // Acceleration due to gravity, 32 ft per sec per sec
```

```
                    // Scaled with 3 digits after the decimal point.
```

```
  FLT k_drag = k_g/15 // Acceleration due to drag as 100 ft per sec
```

```
                    // The drag is proportional to the square of the speed.
```

```
  // Conversion factors
```

```
  FLT mph2fps = 5280.0/(60*60)
```

```
  FLT mph2knots = 128.0/147
```

```

}
```

```

GLOBAL {
  done:ug

  FLT One      // Set to 1.0  Loading globals are cheaper than
  FLT Zro      // Set to 0.0  loading 32-bit constants.

  stepping     // =FALSE if not stepping the simulation
  stepcount
  msecsl
  FLT steprate

  crashed      // =TRUE if crashed
  debugging    // Toggled by the D command.
  plotusage    // Toggled by the U command.

  col_black
  col_blue
  col_green
  col_yellow
  col_red
  col_majenta
  col_cyan
  col_white
  col_darkgray
  col_darkblue
  col_darkgreen
  col_darkyellow
  col_darkred
  col_darkmajenta
  col_darkcyan
  col_gray
  col_lightgray
  col_lightblue
  col_lightgreen
  col_lightyellow
  col_lightred
  col_lightmajenta
  col_lightcyan

  FLT c_throttle; FLT c_trimthrottle; FLT throttle // 0.0 to +1.0
  FLT c_aileron; FLT c_trimaileron; FLT aileron // -1.0 to +1.0
  FLT c_elevator; FLT c_trimelevator; FLT elevator // -1.0 to +1.0

```

```

FLT c_rudder;   FLT c_trimrudder;   FLT rudder    // -1.0 to +1.0

enginestarted   // = TRUE or FALSE
FLT rpm; FLT targetrpm
FLT thrust

FLT rateofclimb // In ft/min

FLT ctn; FLT ctw; FLT cth // Direction cosines of direction t (forward)
FLT cwn; FLT cww; FLT cwh // Direction cosines of direction w (left)
FLT cln; FLT clw; FLT clh // Direction cosines of direction l (lift)

FLT cetn; FLT cetw; FLT ceth // Eye direction cosines of direction t (forward)
FLT cewn; FLT ceww; FLT cewh // Eye direction cosines of direction w (left)
FLT celn; FLT celw; FLT celh // Eye direction cosines of direction l (lift)

FLT eyen; FLT eyew; FLT eyeh // Position of the eye relative to the aircraft.
FLT eyedist // Eye distance from aircraft

FLT rtdot; FLT rwdot; FLT rldot // Anti-clockwise rotation rates about the
// t, w and l axes in radian per second.

// Rotational forces about the aircraft axes.
FLT rft; FLT rft1 // Rotational force about t axis in ft poundals
FLT rfw; FLT rfw1 // Rotational force about w axis
FLT rfl; FLT rfl1 // Rotational force about l axis

cdrawquad3d // (x1,y1,z1, x2,y2,z2, x3,y3,z3, x4,y4,z4)
cdrawtriangle3d // (x1,y1,z1, x2,y2,z2, x3,y3,z3)
// All floating point values.

FLT cockpitl // Height of the pilots eye in ft.

FLT posn; FLT posw; FLT posh // World coordinates of the aircraft origin.
FLT cgn; FLT cgw; FLT cgh // World coordinates of the aircraft CG.
// about 0.6 ft in negative t direction
// from the origin.

FLT cgndot; FLT cgwdot; FLT cghdot // Speeds in ft/s

hatdir // Hat direction
hatmsecs // msec of last hat change
eyedir // Eye direction
// 0 = cockpit view
// 1,...,8 view from behind, behind-left, etc

```

```

// Speed in various directions is measured in ft/s.
FLT tdot; FLT wdot; FLT ldot // Speed in t, w and l directions
FLT tdotsq; FLT wdotsq; FLT ldotsq // Speed squared in t, w and l directions

FLT mass // Mass of the aircraft, typically 2000 lbs

FLT mit; FLT miw; FLT mil // Moment of inertia about t, w and l axes
// 1 corresponds to a mass of 1 lb 1 ft from the axis.

FLT rtdot; FLT rwdot; FLT rldot // Rotation rates about t, w and l axes
// in radians per second.
FLT rdt; FLT rdw; FLT rdl // Rotational damping moment about
// the t, w and l axes

// Linear forces in the three directions
// These are in poundals. 1 poundal will accelerate a mass of 1 lb
// at a rate of 1 ft/s/s. The force of gravity on a mass of 1 lb is
// g poundals, giving an acceleration of g ft/s/s.
FLT ft; FLT ft1 // Force and previous force in t direction
FLT fw; FLT fw1 // Force and previous force in w direction
FLT fl; FLT fl1 // Force and previous force in l direction

// Rotational forces about the three axes.
FLT rft; FLT rft1 // Current and previous moments about t axis
FLT rfw; FLT rfw1 // Current and previous moments about w axis
FLT rfl; FLT rfl1 // Current and previous moments about l axis

FLT atl // Angle of attack

// Tables interpolated by rdtab(a, tab) giving the lift
// and drag coefficients for a given angle a in degrees.
lifftab // Tables giving the lift coefficient.
dragtab // Tables giving the drag coefficient.

// For instance the table lifftab give the lift coefficient caused by air
// coming towards the aircraft at an angle a is the angle between 0 and (ldot,tdot)
// and the direction t. If a>=0 the airflow is coming towards the upper
// of the wing. If a<0 the airflow is coming from the more normal
// direction toward the underside of the wing. If a=170 the air flow is
// from behind and 10 degrees above. If a=-170 the air flow is from behind
// and 10 degrees below.

//          l *(l,t)
//          - ^ / \ Positive angle airflow

```

```

//      / \      | / a )      toward upper surface of
//      | -----*-----> t  the wing.
//      \|
//

// The lift coefficient is greatest when a is about -15 degrees and
// falls off rapidly as a becomes more negative. The wings have a
// built-in angle of attack so even when a=0 the lift coefficient
// is positive.

// dragtab give the drag coefficient based on the airflow angle
// in the tl plane.

FLT usage          // 0 to 100 percentage cpu usage
}

// Insert the definition of drawtigermoth()
GET "drawtigermoth.b"

LET inprod(FLT a, FLT b, FLT c, FLT x, FLT y, FLT z) =
  // Return the cosine of the angle between two unit vectors.
  a*x + b*y + c*z

AND rotate(FLT rt, FLT rw, FLT rl) BE
{ // Rotate the aircraft about axes t, w and l.
  // rt, rw and rl are assumed to be small rotational angles
  // causing rotation about axes t, w, l. Positive values cause
  // anti-clockwise rotations about their axes.

  LET FLT tx =      ctn - rl * cwn + rw * cln
  LET FLT wx =   rl * ctn +      cwn - rt * cln
  LET FLT lx = -rw * ctn + rt * cwn +      cln

  LET FLT ty =      ctw - rl * cww + rw * clw
  LET FLT wy =   rl * ctw +      cww - rt * clw
  LET FLT ly = -rw * ctw + rt * cww +      clw

  LET FLT tz =      cth - rl * cwh + rw * clh
  LET FLT wz =   rl * cth +      cwh - rt * clh
  LET FLT lz = -rw * cth + rt * cwh +      clh

  ctn, ctw, cth := tx, ty, tz
  cwn, cww, cwh := wx, wy, wz
  cln, clw, clh := lx, ly, lz

```

```

adjustlength(@ctn);      adjustlength(@cwn);      adjustlength(@cln)
adjustortho(@ctn, @cwn); adjustortho(@ctn, @cln); adjustortho(@cwn, @cln)
}

```

```

AND radius2(FLT x, FLT y) = VALOF
{ LET FLT rsq = x*x + y*y
  RESULTIS sys(Sys_flt, fl_sqrt, rsq)
}

```

```

AND radius3(FLT x, FLT y, FLT z) = VALOF
{ LET FLT rsq = x*x + y*y + z*z
  RESULTIS sys(Sys_flt, fl_sqrt, rsq)
}

```

```

AND adjustlength(v) BE
{ // This helps to keep vector v of unit length
  LET FLT x, FLT y, FLT z = v!0, v!1, v!2
  LET FLT r = radius3(x,y,z)
  v!0 := x / r
  v!1 := y / r
  v!2 := z / r
}

```

```

AND adjustortho(a, b) BE
{ // This helps to keep the unit vector b orthogonal to a
  LET FLT a0, FLT a1, FLT a2 = a!0, a!1, a!2
  LET FLT b0, FLT b1, FLT b2 = b!0, b!1, b!2
  LET FLT corr = inprod(a0,a1,a2, b0,b1,b2)
  b!0 := b0 - a0 * corr
  b!1 := b1 - a1 * corr
  b!2 := b2 - a2 * corr
}

```

```

AND rdtab(FLT a, tab) = VALOF
{ // Perform linear interpolation between appropriate entries
  // in the given table.
  // tab -> [n, a0,r0, ..., a(n-1), r(n-1)]
  // n must be >= 0 and all ai's must be distinct and increasing.
  // All ai's and ri's are floating point numbers.
  // If a <= a1 return r1
  // If a >= an return rn
  LET n = tab!0
  LET p = tab+1 // First entry
  LET lp = p + 2*n - 2 // Last entry
  LET FLT x0, FLT r0, FLT x1, FLT r1 = ?, ?, ?, ?
}

```



```

IF n=0      RESULTIS 0.0 // No entries
IF a <= p!0 RESULTIS p!1 // a is too small
IF a >= lp!0 RESULTIS lp!1 // a is too large
UNTIL p!0 <= a <= p!2 DO p := p+2 // Find the right segment
x0, r0 := p!0, p!1 // x0 <= a <= x1
x1, r1 := p!2, p!3
// Use linear interpolation between these two entries.
RESULTIS r0 + (r1-r0) * (a-x0) / (x1-x0)
}

AND angle(FLT x, FLT y) = x=0 & y=0 -> 0.0, VALOF
{ // Calculate the angle in degrees between
  // point (x,y) and the x axis using atan2.
  // If (x,y) is above the x-axis the result is between 0 and +180
  // If (x,y) is below the x-axis the result is between 0 and -180
  LET FLT a = sys(Sys_flt, fl_atan2, y, x) * 180.0 / 3.14159
//plotf(20, 30, "angle: x=%13.3f y=%13.3f => angle = %8.3f*n",
//      x, y, a)
  RESULTIS a
}

LET step() BE
{ // Update the aircraft position, orientation and motion.

  // On entry,
  // the position of the aircraft is at cgn, cgw and cgh in
  // real word coordinates.
  // Its speed in directions n, w and h are cgndot, cgwdot and cghdot.
  // The orientation of the aircraft is given by the direction
  // cosines ctn, ctw, cth  direction of thrust
  //          cwn, cww, cwh  direction of the left wing
  //          cln, clw, clh  direction of lift
  // These three directions are orthogonal.

  // The rate of rotation of the aircraft in direction t, w and l
  // are rtdot, rwdot and rldot.

  // Compute the speeds in directions t, w and l from
  // cgndot, cgwdot and cghdot using the direction cosines.

  {
    stepcount := stepcount + 1
    IF stepcount MOD 20 = 0 DO
      { LET prevmsecs = msecs1
        LET v = VEC 2

```

```

    LET s = VEC 15
    datstamp(v)
    msecsl := v!1
    datstring(s)
    steprate := 20 * 1000 / FLOAT(msecsl - prevmsecs)
    //sawritef("stepcount=%n msecsl diff=%i5 steprate = %6.3f %s*n",
    //        stepcount, msecsl-prevmsecs, steprate, s+5)
}
}

tdot := cgndot*ctn + cgwdot*ctw + cghdot*cth
wdot := cgndot*cwn + cgwdot*cww + cghdot*cwh
ldot := cgndot*cln + cgwdot*clw + cghdot*clh

// Calculate the square of the speed in each direction.
tdotsq := tdot * tdot
wdotsq := wdot * wdot
ldotsq := ldot * ldot

//sawritef("tdotsq=%13.1f wdotsq=%13.1f ldotsq=%13.1f*n", tdotsq, wdotsq, ldotsq)

// Calculate the angle of attack in degrees.
// If tdot = 100.0 and ldot = 100.0, atl will be 45.0
// If tdot = 100.0 and ldot = -100.0, atl will be -45.0
//sawritef("angle(100.0, 100.0) = %8.2f*n", angle(100.0, 100.0))
//sawritef("angle(100.0, -100.0) = %8.2f*n", angle(100.0, -100.0))
atl := angle(tdot, ldot) // Positive is airflow is from below in t-l plane

//sawritef("angle(%13.2f, %13.2f) = %8.2f*n", tdot, ldot, angle(tdot, ldot))
//abort(1000)

// Now deal with the aerodynamic and gravity forces on the aircraft.

// The linear forces on the CG of the aircraft in directions
// t, w and l initialised as follows.
ft, fw, fl := Zro, Zro, Zro

// These are in poundals.
// 1 poundal will accelerate a mass of 1 lb at a rate
// of 1 ft/s/s. A force of mass x g will just hold the aircraft
// up against gravity.

// The rotational forces about axes t, w and l initialised as follows.
rft, rfw, rfl := Zro, Zro, Zro

```

```

// These are in ft-poundals.
// 1 ft-poundal will give a body with moment of inertia equivalent
// to a mass of 1 lb at a distance of 1 ft a rotational acceleration
// of 1 radian per second.

// First calculate the engine RPM.
targetrpm := 0.0 // If engine is not started
IF enginestarted DO
{ // The throttle is in the range 0.0 to 1.0
  targetrpm := 600.0 + 1700.0 * throttle +
               0.7 * tdot // + air speed effect
}

// The rpm take time to change.
rpm := rpm + (targetrpm - rpm) / 4.0 - 1.0
IF rpm < 0.0 DO rpm := 0.0
//rpm :=1800.0 // For debugging.

// Now calculate the thrust.
thrust := VALOF
{ // At rpm=2200 the aircraft should read a take off speed of 65mph after
  // travelling about 1700 ft along the runway.
  // Assume the angle of attack of the propeller is such that
  // when rpm=2500 the speed at which the thrust is zero is about 200mph
  // or  $200 * 5280 / (60 * 60) = \text{about } 293.0 \text{ ft/s}$ .

  // At a speed of tdot ft/s the rpm giving zero thrust is
  //  $(2500/293) * \text{tdot}$ . Ie linear between 0 and 293.
  // At a speed of 65mph = 95ft/s the rpm =  $(2500/293) * 95 = 810 \text{ (rpm0)}$ 
  // Assume the the thrust at this speed is  $Kt * (\text{rpm} - \text{rpm0})^2$ 
  // and that the drag is  $Kd * \text{tdot}^2 = Kd * 95^2 = 9025 * Kd$ 
  // Assume that at this speed with rpm=2000 the thrust-drag
  // is sufficient to give the aircraft an acceleration of g/8.
  // Thus  $\text{mass} * g/8 = Kt * (2000 - 810)^2 - 9025 * Kd$ 
  // Assume mass=2000 and g=32, this gives
  //  $2000 * 32/8 = Kt * (2000 - 810)^2 - 9025 * Kd$ 
  // or  $8000 = Kt * 134300 = 9025 * Kd$ 
  LET FLT vmax = 293.0 * rpm / 2500 // Speed in ft/s at which thrust=0
  LET FLT vmaxby2 = vmax/2 // use linear interpolation between vmax and vmaxby2
  LET FLT tmax = 1.7 * mass // Thrust to give acceleration of 1.7 * g
  // ignoring drag.

  LET FLT t = ?
  IF rpm < 600 | tdot > vmax RESULTIS 0.0
  // When rpm >= 600 the thrust is proportional to the square of (rpm-600)
  // When rpm=2200 the thrust is sufficient to accelerate the aircraft at g/8

```

```

    t := tmax * (rpm-600)*(rpm-600) / ((2200-600) * (2200-600))
    IF tdot<vmaxby2 RESULTIS t
    RESULTIS t * (vmax-tdot) / vmaxby2
}

// Next calculate the linear forces on the aircraft.

// Gravity effect
ft := ft - mass * k_g * cth // Gravity in direction t
fw := fw - mass * k_g * cwh // Gravity in direction w
fl := fl - mass * k_g * clh // Gravity in direction l

// Lift and drag force of the main wings.
{ //LET atl = angle(tdot, ldot)
  // Lift is proportions to speed squared (= tdot**2 + ldot**2)
  // multiplied by the lift coefficient rdtab(angle, lifttab)
  // When angle=0 and speed=100 ft/sec lift is mass * k_g which
  // just counteracts gravity.
  // rdtab(0, lifttab) = 1.0
  // so lift = mass * k_g * rdtab(angle, lifttab) * speed/100
  LET FLT a = mass * k_g * rdtab(atl, lifttab)
  LET airspeed = radius2(tdot, ldot)
  // Main wing lift force due to air at speed airspeed coming
  // towards the aircraft at angle atl in the tl plane.
  fl := fl + 1.4 * a * airspeed / 100.0
  // Main wing drag force.
  //ft := ft + 0.1 * b * (tdot*tdot+ldot*ldot)
}

// Airframe drag force -- using quartic to increase the
// drag effect at high speed.
ft := ft - 0.020 * mass * (tdot * tdot * tdot * tdot) / 100000000.0

// Side effect
fw := fw - 0.5 * mass * wdot // Sideways force

// Thust force
ft := ft + thrust

// Apply linear forces ft, fw and fl using the trapizoidal rule
// for integration.
tdot := tdot + (ft+ft1)/(mass*steprate)
wdot := wdot + (fw+fw1)/(mass*steprate)
ldot := ldot + (fl+fl1)/(mass*steprate)

```

```

ft1, fw1, fl1 := ft, fw, fl // Save the previous values

// Calculate the real world velocity
cgndot := tdot*ctn + wdot*cwn + ldot*cln
cgwdot := tdot*ctw + wdot*cww + ldot*clw
cghdot := tdot*cth + wdot*cwh + ldot*clh

// Calculate new n, w and h positions.
cgn := cgn + cgndot / steprate
cgw := cgw + cgwdot / steprate
cgh := cgh + cghdot / steprate

//writef("cgn=%13.3f  cgw=%13.3f  cgh=%13.3f*n", cgn, cgw, cgh)
//abort(1003)

// Calculate the rotational forces rft, rfw and rfl

// Dihedral effect
// If wdot>0 there is a clockwise force about the t axis
rft := rft - 0.005 * mit * wdot

// Fixed stabiliser effect
// If ldot>0 there is an anti-clockwise force about the w axis
rfw := rfw + 4500*(ldot - 15.0 * rwdot) / mil

// Fixed fin effect
// If wdot>0 there is an clockwise force about the l axis.
rfl := rfl - 950*(wdot + 15.0 * rldot) / mil

// Aileron effect
rft := rft - 0.001 * aileron * mit * tdot

// Elevator effect
rfw := rfw - 0.002 * elevator * miw * (tdot+rpm/50)

// Rudder effect
rfl := rfl + 0.001 * rudder * mil * (tdot+rpm/10)

// Apply rotational damping.
// rtdot, rwdot and rldot are in radians per second.
rft := rft - 0.8 * mit * rtdot
rfw := rfw - 3.0 * miw * rwdot
rfl := rfl - 0.8 * mil * rldot

```

```

//writef("rft=%9.6f rft1=%9.6f*n", rft, rft1)
//writef("rfw=%9.6f rfw1=%9.6f*n", rft, rft1)
//writef("rfl=%9.6f rfl1=%9.6f*n", rft, rft1)

// Apply rotational effects using the trapizoidal rule.
rtdot := rtdot + (rft+rft1)/(mit * steprate * 2)
rwdot := rwdot + (rfw+rfw1)/(miw * steprate * 2)
rldot := rldot + (rfl+rfl1)/(mil * steprate * 2)

rft1, rfw1, rfl1 := rft, rfw, rfl // Save previous values

// Limit rotational rates to no more than 1 radian per second
//IF rtdot > 1.0 DO rtdot := 1.0
//IF rtdot < -1.0 DO rtdot := -1.0
//IF rwdot > 1.0 DO rwdot := 1.0
//IF rwdot < -1.0 DO rwdot := -1.0
//IF rldot > 1.0 DO rldot := 1.0
//IF rldot < -1.0 DO rldot := -1.0

// Rotate the aircraft.
// Anti-clockwise rotation rates in radians per second
// about axes t, w and l.
rotate(rtdot/steprate, rwdot/steprate, rldot/steprate)

// Test for contact with the ground.
IF cgh < 10.0 DO
{ // The aircraft is near the ground

    IF cgh < 2.0 | clh<0.8 DO
    { crashed := TRUE
      stepping := FALSE
      RETURN
    }
}
}

AND plotcraft() BE
{ IF depthscreen FOR i = 0 TO screenxsize*screenysize-1 DO
  depthscreen!i := FLOAT maxint
  // Draw a Tigermoth
  drawtigermoth(elevator, aileron, rudder)
}

AND gdrawquad3d(FLT x1, FLT y1, FLT z1,
                FLT x2, FLT y2, FLT z2,

```

```

        FLT x3, FLT y3, FLT z3,
        FLT x4, FLT y4, FLT z4) BE
{ // Draw a 3D quad (not rotated)
  LET FLT sx1, FLT sy1, FLT sz1 = ?,?,?
  LET FLT sx2, FLT sy2, FLT sz2 = ?,?,?
  LET FLT sx3, FLT sy3, FLT sz3 = ?,?,?
  LET FLT sx4, FLT sy4, FLT sz4 = ?,?,?

  UNLESS screencoords(x1-eyen-cgn, y1-eyew-cgw, z1-eyeh-cgh, @sx1) RETURN
  UNLESS screencoords(x2-eyen-cgn, y2-eyew-cgw, z2-eyeh-cgh, @sx2) RETURN
  UNLESS screencoords(x3-eyen-cgn, y3-eyew-cgw, z3-eyeh-cgh, @sx3) RETURN
  UNLESS screencoords(x4-eyen-cgn, y4-eyew-cgw, z4-eyeh-cgh, @sx4) RETURN

  drawquad3d(FIX sx1, FIX sy1, FIX sz1,
             FIX sx2, FIX sy2, FIX sz2,
             FIX sx3, FIX sy3, FIX sz3,
             FIX sx4, FIX sy4, FIX sz4)
}

AND cdrawquad3d(FLT x1, FLT y1, FLT z1,
               FLT x2, FLT y2, FLT z2,
               FLT x3, FLT y3, FLT z3,
               FLT x4, FLT y4, FLT z4) BE
{ LET FLT rx1 = x1*ctn + y1*cwn + z1*cln
  LET FLT ry1 = x1*ctw + y1*cww + z1*clw
  LET FLT rz1 = x1*cth + y1*cwh + z1*clh

  LET FLT rx2 = x2*ctn + y2*cwn + z2*cln
  LET FLT ry2 = x2*ctw + y2*cww + z2*clw
  LET FLT rz2 = x2*cth + y2*cwh + z2*clh

  LET FLT rx3 = x3*ctn + y3*cwn + z3*cln
  LET FLT ry3 = x3*ctw + y3*cww + z3*clw
  LET FLT rz3 = x3*cth + y3*cwh + z3*clh

  LET FLT rx4 = x4*ctn + y4*cwn + z4*cln
  LET FLT ry4 = x4*ctw + y4*cww + z4*clw
  LET FLT rz4 = x4*cth + y4*cwh + z4*clh

  LET FLT sx1, FLT sy1, FLT sz1 = ?,?,?
  LET FLT sx2, FLT sy2, FLT sz2 = ?,?,?
  LET FLT sx3, FLT sy3, FLT sz3 = ?,?,?
  LET FLT sx4, FLT sy4, FLT sz4 = ?,?,?

  UNLESS screencoords(rx1-eyen, ry1-eyew, rz1-eyeh, @sx1) RETURN

```

```

UNLESS screencoords(rx2-eyen, ry2-eyew, rz2-eyeh, @sx2) RETURN
UNLESS screencoords(rx3-eyen, ry3-eyew, rz3-eyeh, @sx3) RETURN
UNLESS screencoords(rx4-eyen, ry4-eyew, rz4-eyeh, @sx4) RETURN

drawquad3d(FIX sx1, FIX sy1, sz1,
           FIX sx2, FIX sy2, sz2,
           FIX sx3, FIX sy3, sz3,
           FIX sx4, FIX sy4, sz4)
}

AND cdrawtriangle3d(FLT x1, FLT y1, FLT z1,
                   FLT x2, FLT y2, FLT z2,
                   FLT x3, FLT y3, FLT z3) BE
{ LET FLT rx1 = x1*ctn + y1*cwn + z1*cln
  LET FLT ry1 = x1*ctw + y1*cww + z1*clw
  LET FLT rz1 = x1*cth + y1*cwh + z1*clh

  LET FLT rx2 = x2*ctn + y2*cwn + z2*cln
  LET FLT ry2 = x2*ctw + y2*cww + z2*clw
  LET FLT rz2 = x2*cth + y2*cwh + z2*clh

  LET FLT rx3 = x3*ctn + y3*cwn + z3*cln
  LET FLT ry3 = x3*ctw + y3*cww + z3*clw
  LET FLT rz3 = x3*cth + y3*cwh + z3*clh

  LET FLT sx1, FLT sy1, FLT sz1 = ?,?,?
  LET FLT sx2, FLT sy2, FLT sz2 = ?,?,?
  LET FLT sx3, FLT sy3, FLT sz3 = ?,?,?

  UNLESS screencoords(rx1-eyen, ry1-eyew, rz1-eyeh, @sx1) RETURN
  UNLESS screencoords(rx2-eyen, ry2-eyew, rz2-eyeh, @sx2) RETURN
  UNLESS screencoords(rx3-eyen, ry3-eyew, rz3-eyeh, @sx3) RETURN

//newline()
//writef("x1=%13.3f y1=%13.3f z1=%13.3f*n", x1, y1, z1)
//writef("x2=%13.3f y2=%13.3f z2=%13.3f*n", x2, y2, z2)
//writef("x3=%13.3f y3=%13.3f z3=%13.3f*n", x3, y3, z3)

//writef("ctn=%6.3f cwn=%6.3f cln=%6.3f radius3=%8.3f*n", ctn, cwn, cln, radius3(ctn,cwn,cln)
//writef("ctw=%6.3f cww=%6.3f clw=%6.3f radius3=%8.3f*n", ctw, cww, clw, radius3(ctw,cww,clw)
//writef("cth=%6.3f cwh=%6.3f clh=%6.3f radius3=%8.3f*n", cth, cwh, clh, radius3(cth,cwh,clh)

//writef("sx1=%13.3f sy1=%13.3f sz1=%13.3f*n", sx1, sy1, sz1)
//writef("sx2=%13.3f sy2=%13.3f sz2=%13.3f*n", sx2, sy2, sz2)
//writef("sx3=%13.3f sy3=%13.3f sz3=%13.3f*n", sx3, sy3, sz3)

```



```

drawtriangle3d(FIX sx1, FIX sy1, sz1,
              FIX sx2, FIX sy2, sz2,
              FIX sx3, FIX sy3, sz3)
//writef("sx1=%5i sy1=%5i sz1=%13.1f*n", FIX sx1, FIX sy1, sz1)
//writef("sx2=%5i sy2=%5i sz2=%13.1f*n", FIX sx2, FIX sy2, sz2)
//writef("sx3=%5i sy3=%5i sz2=%13.1f*n", FIX sx3, FIX sy3, sz3)

//updatescreen()
//delay(1000)
//abort(1000)
}

AND screencoords(FLT x, FLT y, FLT z, v) = VALOF
{ // If the point (x,y,z) is in view, set v!0, v!1 and v!2 to
  // the integer screen coordinates and depth and return TRUE
  // otherwise return FALSE
  LET FLT sx = x*cewn + y*ceww + z*cewh // Horizontal
  LET FLT sy = x*celn + y*celw + z*celh // Vertical
  LET FLT sz = x*cetn + y*cetw + z*ceth // Depth
  LET FLT fscreenxsize = fscreenxsize<=fscreenysize -> fscreenxsize, fscreenysize

//writef("screencoords: x=%13.3f y=%13.3f z=%13.3f*n", x,y,z)
//writef("cetn=%6.3f cetw=%6.3f ceth=%6.3f*n", cetn,cetw,ceth)
//writef("cewn=%6.3f ceww=%6.3f cewh=%6.3f*n", cewn,ceww,cewh)
//writef("celn=%6.3f celw=%6.3f celh=%6.3f*n", celn,celw,celh)
//writef("eyen=%13.3f eyew=%13.3f eyeh=%13.3f*n", eyen,eyew,eyeh)
//writef(" sx=%13.3f sy=%13.3f sz=%13.3f*n", sx,sy,sz)

  // Test that the point is in view, ie at least 1.0ft in front
  // and no more than about 27 degrees (inverse tan 1/2) from the
  // direction of view.
  IF sz<1 & sz*sz / 2 >= sx*sx + sy*sy
    RESULTIS FALSE

  // A point screensize pixels away from the centre of the screen is
  // 45 degrees from the direction of view.
  // Note that many pixels in this range are off the screen.
  v!0 := fscreenxsize * 0.5 - fscreenysize * (sx / sz) * 2
  v!1 := fscreenysize * 0.5 + fscreenysize * (sy / sz) * 2 + 200.0
  v!2 := sz // This distance into the screen in arbitrary units, used
  // for hidden surface removal.
//writef("screencoords: v!0=%13.3f v!1=%13.3f v!2=%13.3f)*n", v!0, v!1, v!2)
//abort(1119)
  RESULTIS TRUE
}

```

```

}

AND orthocoords(FLT n, FLT w, FLT h, v) = VALOF
{ // (n,w,h) is a point relative to (cgn,cgw,cgh).
  // It is viewed with orientation (t,w,l) using an orthogonal projection.
  // The screen (x,y) coordinates are placed in v!0 and v!1.
  // The result is TRUE if (n,w,h) is in front.
  LET sx, sy = 0.0, 0.0
  LET res = FALSE

  // Screen z is the inner product of (n,w,h) and (ctn,ctw,cth)
  IF n*ctn + w*ctw + h*cth > 0.0 DO
  { // The direction of motion circle is in front
    // Screen x is the inner product of (n,w,h) and (cwn,cww,cwh)
    sx := n*cwn + w*cww + h*cwh
    // Screen y is the inner product of (n,w,h) and (cln,clw,clh)
    sy := n*cln + w*clw + h*clh
    res := TRUE

    //writef("orthocoords:*n")
    //writef(" ctn=%6.3f ctw=%6.3f cth=%6.3f*n", ctn,ctw,cth)
    //writef(" cwn=%6.3f cww=%6.3f cwh=%6.3f*n", cwn,cww,cwh)
    //writef(" cln=%6.3f clw=%6.3f clh=%6.3f*n", cln,clw,clh)
    //writef(" n=%13.3f w=%13.3f h=%13.3f*n", n,w,h)
    //writef("sx=%13.3f sy=%13.3f*n", sx,sy)
    v!0 := FIX(fscreenxsize - 100 - sx)
    v!1 := FIX(fscreenysize * 0.5 + sy)
    //writef("v!0=%6i v!1=%6i*n", v!0,v!1)
    RESULTIS TRUE
  }

  v!0 := -1
  v!1 := -1
  //writef("v!0=%6i v!1=%6i*n", v!0,v!1)
  RESULTIS FALSE
}

AND draw_artificial_horizon() BE
{ // This function draws the artificial horizon and a small circle
  // representing the direction of travel.
  // The n and w components of the direction of thrust t are used
  // to make a horizontal vector (n,w,0) which is above or below
  // the direction of thrust. This is then scaled to make it of
  // unit length. Suppose the resulting vector is d = (dn,dw,0).
  // Let P be a point in direction d 100 ft from the aircraft's CG,

```

```

// ie (100dn, 100dw,0). This point will be above of below the
// line in direction t from the CG.
// P (cgn+100dn,cgw+100dw,cgh) is in world coordinates.
// The artificial horizon is made up of four line segments
// A-B, B-C, C-D and D-E where A, B, D and E are on
// the horizontal line passing through P at right angles to d.
// A is 30ft to the left of P and E is 30ft to the right of P.
// On the screen, B, C and D form an equilateral triangle half
// way between A and E.

// The direction of motion is represented by a small circle at
// point X which has coordinates (cgn+100xn,cgw+100xw,cgh+100xh)
// where (xn,xw,xh) is a unit vector in direction
// (cgndot,cgwdot,cghdot). The screen position of X is calculated
// using the same orthogonal projection as the points A, B, C, D
// and E.

LET px, py = ?, ? // For screen coordinates
LET ax, ay = ?, ? // For screen coordinates
LET bx, by = ?, ? // For screen coordinates
LET cx, cy = ?, ? // For screen coordinates
LET dx, dy = ?, ? // For screen coordinates
LET ex, ey = ?, ? // For screen coordinates
LET FLT n, FLT w, FLT h = ctn, ctw, 0.0 // A horizontal vector
LET FLT a, FLT b, FLT c = ?, ?, ? // Unit vector orthogonal to (n,w,h)
LET FLT Pn, FLT Pw, FLT Ph = ?, ?, ?
LET FLT An, FLT Aw, FLT Ah = ?, ?, ?
LET FLT En, FLT Ew, FLT Eh = ?, ?, ?
LET FLT Xn, FLT Xw, FLT Xh = ?, ?, ? // A point in direction
// (cgndot,cgwdot,cghdot).

setcolour(col_white)

//{ moveto(100,200)
// drawto(110,210)
//}
//updatescreen()
//abort(1002)

adjustlength(@n) // Make (n,w,0) a unit vector, direction d.

// Make a unit vector in direction A->E (orthogonal to d).
a, b, c := w, -n, 0.0

```

```

// Set P to be 100ft from CG in direction d
Pn, Pw, Ph := cgn+100*n, cgw+100*w, cgh // A point on the horizon
// 100ft from CG.

// Set A 30ft left of from P.
An, Aw, Ah := Pn-30*a, Pw-30*b, Ph
// Set A 30ft left of from P.
En, Ew, Eh := Pn+30*a, Pw+30*b, Ph

//      A-----B P D-----E
//              \ /
//              C
//
// AE is othogonal to the line from CG to P.
//

orthocoords(An-cgn, Aw-cgw, Ah-cgh, @ax)
orthocoords(En-cgn, Ew-cgw, Eh-cgh, @ex)
px, py := (ax+ex)/2, (ay+ey)/2
bx, by := px + (ax-ex)*5/60, py + (ay-ey)*5/60
dx, dy := px - (ax-ex)*5/60, py - (ay-ey)*5/60
// BCD is an equilateral triangle with sides of length 10,
// CP has length appoximately 8.66.
// (ey-ay, ax-ay) is a vector of length 60 in direction PC
// so the screen coordinates of C can be calculated as follows.
cx, cy := px+(ey-ay)*8_66/60_00, py+(ax-ex)*8_66/60_00
// We can now draw the artificial horizon
moveto(ax,ay)
drawto(bx,by)
drawto(cx,cy)
drawto(dx,dy)
drawto(ex,ey)

// Set (n,w,h) to be a point in direction (cgndot,cgwdot,cghdot).
n, w, h := cgndot, cgwdot, cghdot
// Make (n,w,h) a unit vector
adjustlength(@n)
// X is the centre of the direction of motion circle.
Xn, Xw, Xh := cgn+100*n, cgw+100*w, cgh+100*h

//plotf(20, 85, "Xn=%i6 Xw=%i6 Dn=%i6", FIX (Xn-cgn), FIX (Xw-cgw), FIX (Xh-cgh))
IF orthocoords(Xn-cgn, Xw-cgw, Xh-cgh, @px) DO
{ drawcircle(px, py, 5)
//writef("Draw circle at %n %n*n", px,py)
}

```

```

//updatescreen()
//abort(1001)
}

AND draw_ground_point(FLT x, FLT y) BE
{ LET FLT gx, FLT gy, FLT gz = Zro, Zro, Zro
//newline()
//writef("draw_ground_point: x=%13.2f y=%13.2f*n", x, y)
//writef("draw_ground_point: cgn=%13.2f cgw=%13.2f cgh=%13.2f*n", cgn, cgw, cgh)
//abort(1001)
  IF screencoords(x-cgn, y-cgw, -cgh-cockpit1, @gx) DO
  {
//writef("gx=%13.3f gy=%13.3f gz=%13.3f*n", gx, gy, gz)
  drawrect(FIX gx, FIX gy, FIX gx+2, FIX gy+2)
  updatescreen()
//abort(1000)
  }
}

AND drawgroundpoints() BE
{
  setcolour(col_red)
  gdrawquad3d( 0.0,  -5.0, 1.0,
              20.0,  -5.0, 1.0,
              20.0,   5.0, 1.0,
              0.0,   5.0, 1.0)
  setcolour(col_green)
  gdrawquad3d(20.0,  -5.0, 1.0,
              40.0,  -5.0, 1.0,
              40.0,   5.0, 1.0,
              20.0,   5.0, 1.0)
// updatescreen()

//IF FALSE DO
  FOR x = 0 TO 200-150 BY 20 DO
  { LET FLT fx = FLOAT x
    FOR y = -50 TO 45 BY 5 DO
    { LET FLT fy = FLOAT y
      LET r = ABS(3*x + 5*y) MOD 73
      LET g = ABS(53*x + 25*y) MOD 73
      LET b = ABS(103*x + 125*y) MOD 73
//sawritef("fx=%13.3f fy=%13.3f*n", fx, fy)
      setcolour(maprgb(30+r,30+g,30+b))
//writef("Calling gdrawquad3d*n")
      gdrawquad3d(fx,  fy,  Zro,

```

```

                fx+20, fy,   Zro,
                fx+20, fy+5, Zro,
                fx,   fy+5, Zro)
        //updatescreen()
    }
}

RETURN

        setcolour(col_white)
        ///draw_ground_point(      Zro,      Zro)
IF FALSE DO
    FOR x = 0 TO 3000 BY 100 DO
    { LET FLT fx = FLOAT x
      draw_ground_point(fx, -50.0)
      draw_ground_point(fx, +50.0)
    }
// draw_ground_point(3000.0, Zro)

IF FALSE DO
    FOR k = 1000 TO 10000 BY 1000 DO
    { LET FLT fk = FLOAT k
      setcolour(col_lightmajenta)
      IF fk > 3000.0 DO draw_ground_point( k,  Zro)
      setcolour(col_white)
      draw_ground_point(-fk,  Zro)
      setcolour(col_red)
      draw_ground_point( Zro,  fk)
      setcolour(col_green)
      draw_ground_point( Zro, -fk)
    }
}

AND initposition(n) BE SWITCHON n INTO
{ DEFAULT:

    CASE 1: // Take off position
        cgn,   cgw,   cgh   := 100.0,  0,  100.0
        cgndot, cgwdot, cghdot := Zro,  Zro,  Zro

        tdot,   wdot,   ldot   := Zro, Zro, Zro // Not needed

        // The aircraft orientation
        ctn,   ctw,   cth := One, Zro, Zro // Direction cosines of aircraft

```

```

cwn, cww, cwh := Zro, One, Zro
cln, clw, clh := Zro, Zro, One

rtdot, rwdot, rldot := Zro, Zro, Zro // Rate of rotation

// Linear forces
ft,  fw,  fl  := Zro, Zro, Zro
ft1, fw1, fl1 := Zro, Zro, Zro // Previous linear forces

// Rotational forces
rft, rfw, rfl := Zro, Zro, Zro
rft1, rfw1, rfl1 := Zro, Zro, Zro // Previous rotational forces

stepping := TRUE
crashed := FALSE
enginestarted, rpm := FALSE, 0.0
targetrpm := rpm
RETURN

CASE 2: // Position on the glide slope
cgn,  cgw,  cgh  := -4000.0, Zro, 1000.0 // Height of 1000 ft
cgndot, cgwdot, cghdot := 100.0, Zro, Zro

tdot,  wdot,  ldot  := 100.0, Zro, Zro // Not needed

// The aircraft orientation
ctn, ctw, cth := One, Zro, Zro // Direction cosines with
cwn, cww, cwh := Zro, One, Zro // six decimal digits
cln, clw, clh := Zro, Zro, One // after to decimal point.

rtdot, rwdot, rldot := Zro, Zro, Zro

// Linear forces
ft,  fw,  fl  := Zro, Zro, Zro
ft1, fw1, fl1 := Zro, Zro, Zro // Previous linear forces

// Rotational forces
rft, rfw, rfl := Zro, Zro, Zro
rft1, rfw1, rfl1 := Zro, Zro, Zro // Previous rotational forces

stepping := TRUE
crashed := FALSE
enginestarted, rpm := TRUE, 1600.0
targetrpm := rpm
RETURN

```

```

CASE 3: // Set flying level at 10000 ft at 65mph
  cgn,   cgw,   cgh   := -10_000.0, Zro, 10000.0 // Height of 10000 ft
  cgndot, cgwdot, cghdot := 95.0, Zro, Zro // 65mph = 95 ft/s
//cgwdot := 15.0
  tdot,   wdot,   ldot   := cgndot, cgwdot, cghdot

  // The aircraft orientation
  ctn, ctw, cth := One, Zro, Zro // Direction cosines of aircraft.
  cwn, cww, cwh := Zro, One, Zro
  cln, clw, clh := Zro, Zro, One

  rtdot, rwdot, rldot := Zro, Zro, Zro // Rate of rotation

  // Linear forces
  ft,   fw,   fl   := Zro, Zro, Zro
  ft1, fw1, fl1 := Zro, Zro, Zro // Previous linear forces

  // Rotational forces
  rft, rfw, rfl := Zro, Zro, Zro
  rft1, rfw1, rfl1 := Zro, Zro, Zro // Previous rotational forces

  ft1, fw1, fl1 := Zro, Zro, Zro // Previous linear forces
  rft1, rfw1, rfl1 := Zro, Zro, Zro // Previous rotational forces

  stepping := TRUE
  crashed := FALSE
  enginestarted, rpm := TRUE, 1900.0
  targetrpm := rpm
  RETURN
}

LET start() = VALOF
{ LET v = VEC 2
  datstamp(v)
  msecsl := v!1
  One := 1.0
  Zro := 0.0
  stepcount := 0
  steprate := 5.0

  // FOR i = 1 TO 10 DO
  // { LET t0 = sys(Sys_cputime)
  //   LET v = VEC 3

```



```

//    LET s = VEC 16
//    datstamp(v)
//    datstring(s)
//    sawritef("%i4: msec1=%i8  %s*n", i, v!1, s+5)
//    delay(1000)
//  }

//writef("%8x %-%32b*n%-%20.6f*n%-%20.3e*n", 123.456789)
//writef("%8x %-%32b*n%-%20.6f*n%-%20.3e*n", 123.456789e20)
//writef("%8x %-%32b*n%-%20.6f*n%-%20.3e*n", 123.456789e-20)
//RESULTIS 0

//writef("radius3(0.0, 0.0, 0.0) = %13.3f*n", radius3(0.0, 0.0, 0.0))
//writef("radius3(1.0, 1.0, 0.0) = %13.3f*n", radius3(1.0, 1.0, 0.0))
//writef("radius3(3.0, 0.0, 4.0) = %13.3f*n", radius3(3.0, 0.0, 4.0))
//writef("radius3(0.0, 3.0, -4.0) = %13.3f*n", radius3(0.0, 3.0, -4.0))
//abort(1000)

//  writef("3.1           =%20.9e %-%13.9f*n", 3.1)
//  writef("3.14          =%20.9e %-%13.9f*n", 3.14)
//  writef("3.141         =%20.9e %-%13.9f*n", 3.141)
//  writef("3.1415        =%20.9e %-%13.9f*n", 3.1415)
//  writef("3.14159       =%20.9e %-%13.9f*n", 3.14159)
//  writef("3.141592      =%20.9e %-%13.9f*n", 3.141592)
//  writef("3.1415926     =%20.9e %-%13.9f*n", 3.1415926)
//  writef("3.14159265    =%20.9e %-%13.9f*n", 3.14159265)
//  writef("3.141592653   =%20.9e %-%13.9f*n", 3.141592653)
//  writef("3.1415926535  =%20.9e %-%13.9f*n", 3.1415926535)
//  writef("3.14159265358 =%20.9e %-%13.9f*n", 3.14159265358)
//  writef("3.141592653589 =%20.9e %-%13.9f*n", 3.141592653589)
//  writef("3.1415926535897 =%20.9e %-%13.9f*n", 3.1415926535897)
//  writef("3.14159265358979 =%20.9e %-%13.9f*n", 3.14159265358979)
//  writef("3.141592653589793 =%20.9e %-%13.9f*n", 3.141592653589793)
//RESULTIS 0
//  angle( 1.0, 0.0)
//  angle( 0.0, 1.0)
//  angle(-1.0, 0.0)
//  angle( 0.0, -1.0)
//  angle( 1.0, 1.0)
//  angle(-1.0, 1.0)
//  angle(-1.0, -1.0)
//  angle( 1.0, -1.0)
//RESULTIS 0
  IF FALSE DO
    { // Test rdtab

```

```

writef("Testing rdtab*n")
FOR a = -200 TO 200 BY 10 DO
{ LET fa = FLOAT a
  LET val = Zro
  LET tab = TABLE    3,
                    -150.0, 100.000,
                      0.0, -50.000,
                      100.0,  0.000,
                      150.0, 100.000
  val := rdtab(fa, tab)
  IF a MOD 25 = 0 DO writef("*n%9.1f:", fa)
  writef(" %8.3f", rdtab(fa, tab))
}
newline()
RESULTIS 0
}

IF FALSE DO
{ // The the angle function
writef("x=%8.3f y=%8.3f angle=%9.3f*n", 1.000, 1.000, angle( 1.000, 1.000))
writef("x=%8.3f y=%8.3f angle=%9.3f*n", 0.000, 1.000, angle( 0.000, 1.000))
writef("x=%8.3f y=%8.3f angle=%9.3f*n",-1.000, 1.000, angle(-1.000, 1.000))
writef("x=%8.3f y=%8.3f angle=%9.3f*n",-1.000,-1.000, angle(-1.000,-1.000))
writef("x=%8.3f y=%8.3f angle=%9.3f*n", 1.000,-1.000, angle( 1.000,-1.000))
writef("x=%8.3f y=%8.3f angle=%9.3f*n",-1.000, 0.000, angle(-1.000, 0.000))
writef("x=%8.3f y=%8.3f angle=%9.3f*n", 0.060, 0.001, angle( 0.060, 0.001))
writef("x=%8.3f y=%8.3f angle=%9.3f*n", 0.060,-0.001, angle( 0.060,-0.001))

writef("x=%8.3f y=%8.3f angle=%9.3f*n",-1.000, 0.001, angle(-1.000, 0.001))
writef("x=%8.3f y=%8.3f angle=%9.3f*n",-1.000,-1.000, angle(-1.000,-1.000))
RESULTIS 0
}

initposition(1) // Get ready for take off

cetn, cetw, ceth := ctn, ctw, cth
cewn, ceww, cewh := cwn, cww, cwh
celn, celw, celh := cln, clw, clh

eyen, eyew, eyeh := Zro, Zro, Zro // Relative eye position
//hatdir, hatmsecs, eyedir := 0, 0, 0
hatdir, hatmsecs := #b0001, 0 // From behind
eyedir := 1
eyedist := 100.0 // Eye x or y distance from aircraft

```

```

cockpitl := 6.0 // Cockpit 8 feet above the ground

c_throttle, c_elevator, c_aileron, c_rudder := Zro, Zro, Zro, Zro
c_trimthrottle, c_trimelevator, c_trimaileron, c_trimrudder := Zro, Zro, Zro, Zro
throttle, elevator, aileron, rudder := Zro, Zro, Zro, Zro

// Set rotational damping parameters
rdt, rdw, rdl := 1.800, 1.800, 1.800

ft, fw, fl := Zro, Zro, Zro
ft1, fw1, fl1 := Zro, Zro, Zro
rft, rfw, rfl := Zro, Zro, Zro
rft1, rfw1, rfl1 := Zro, Zro, Zro
rtdot, rwdot, rldot := Zro, Zro, Zro
//writef("%13.1f %13.1f %13.1f*n", cgn, cgw, cgh)

usage := 0

initsdl()
mkscreen("Tiger Moth", 800, 500)

// Declare a few colours in the pixel format of the screen
col_black := maprgb( 0, 0, 0)
col_blue := maprgb( 0, 0, 255)
col_green := maprgb( 0, 255, 0)
col_yellow := maprgb( 0, 255, 255)
col_red := maprgb(255, 0, 0)
col_majenta := maprgb(255, 0, 255)
col_cyan := maprgb(255, 255, 0)
col_white := maprgb(255, 255, 255)
col_darkgray := maprgb( 64, 64, 64)
col_darkblue := maprgb( 0, 0, 64)
col_darkgreen := maprgb( 0, 64, 0)
col_darkyellow := maprgb( 0, 64, 64)
col_darkred := maprgb( 64, 0, 0)
col_darkmajenta := maprgb( 64, 0, 64)
col_darkcyan := maprgb( 64, 64, 0)
col_gray := maprgb(128, 128, 128)
col_lightblue := maprgb(128, 128, 255)
col_lightgreen := maprgb(128, 255, 128)
col_lightyellow := maprgb(128, 255, 255)
col_lightred := maprgb(255, 128, 128)
col_lightmajenta := maprgb(255, 128, 255)
col_lightcyan := maprgb(255, 255, 128)

```

```

done      := FALSE
debugging := TRUE//FALSE
plotusage := FALSE

mass := 2000.0 // Aircraft mass is 2000 lbs
mit  := 200.0  // Moment of inertial about t
miw  := 400.0  // Moment of inertial about w
mil  := 400.0  // Moment of inertial about l

lifftab := TABLE      10, // 10 entries
                -180.000, -0.100, // The angle is relative to direction t
                -90.000,  0.400,
                -15.000,  0.100, // Stalled
                -11.000,  2.000,
                 0.000,  1.000, // Lift coefficient when ldot=0
                 4.000,  0.000,
                19.000, -0.600,
                24.000, -0.100, // Inverted stall
                90.000, -0.400,
                180.000, -0.100

initposition(3)
updatescreen()
plotscreen()
//abort(1000)

UNTIL done DO
{ // Read joystick and keyboard events
  LET t0 = sdlmsecs()
  LET t1 = ?

  processevents()

  IF stepping DO step()

  //writef("x=%9.2f y=%9.2f h=%9.2f %9.2f*n", cgn, cgw, cgh, tdot)
  plotscreen()

  updatescreen()

  t1 := sdlmsecs()
//writef("time %9.3d %9.3d %9.3d %9.3d*n", t0, t1, t1-t0, t0+100-t1)
  usage := 100*(t1-t0)/100

```

```

    //IF t0+100 < t1 DO
        //sdlldelay(t0+100-t1)
        sdlldelay(100)
        //sdlldelay(900)
//abort(1111)
}

writef(" *nQuitting*n")
sdlldelay(0_100)
closesdl()
RESULTIS 0
}

AND drawcontrols() BE
{ LET mx = screenxsize/2
  LET my = screenysize - 70 //- 100

  seteyeposition()

  fillsurf(col_blue)

  setcolour(col_lightcyan)

  drawstring(240, 50, done -> "Quitting", "Tiger Moth Flight Simulator")

  setcolour(col_lightgray) // Draw runway line
  moveto(mx-1, my)
  drawby(0, FIX(3000.0/100.0))
  moveto(mx, my)
  drawby(0, FIX(3000.0/100.0))
  moveto(mx+1, my)
  drawby(0, FIX(3000.0/100.0))

  { LET dx =    FIX(ctn*20) // Orientation of the aircraft
    LET dy =    FIX(ctw*20)
    LET sdx =   dx / 10    // Ground speed of the aircraft
    LET sdy =   dy / 10
    LET x  = mx-FIX(cgw/100)
    LET y  = my+FIX(cgn/100)
    LET tx = x+5*dy/8
    LET ty = y-5*dx/8
    setcolour(col_red) // Draw aircraft symbol
    moveto(x-dy/4, y+dx/4) // Fuselage
    drawby(+dy, -dx)
    moveto( x-dx/2, y-dy/2) // Wings
  }
}

```

```

    drawby(+dx, +dy)
    moveto(tx, ty)          // Tail
    moveby(dx/4, dy/4)
    drawby(-dx/2, -dy/2)
}

// Draw the controls
setcolour(col_darkgray)
drawfillrect(screenxsize-20-100, screenysize-20-100, // Joystick
             screenxsize-20,      screenysize-20)
drawfillrect(screenxsize-50-100, screenysize-20-100, // Throttle
             screenxsize-30-100, screenysize-20)
drawfillrect(screenxsize-20-100, screenysize-50-100, // Rudder
             screenxsize-20,      screenysize-30-100)

IF crashed DO
{ setcolour(col_red)
  plotf(mx-50, my+50, "CRASHED")
}

setcolour(col_green)    // Real world velocity
moveto(mx, my)
drawby(-FIX(cgwdot/10), FIX(cgndot/10))

{ LET pos = FIX(80 * throttle)
  setcolour(col_red)
  drawfillrect(screenxsize-45-100, pos+screenysize-15-100,
              screenxsize-35-100, pos+screenysize- 5-100)
}

{ LET pos = FIX(45 * rudder)
  setcolour(col_red)
  drawfillrect(pos+screenxsize-25-50, -5+screenysize-40-100,
              pos+screenxsize-15-50, +5+screenysize-40-100)
}

{ LET posx = FIX(45 * aileron)
  LET posy = FIX(45 * elevator)
  setcolour(col_red)
  drawfillrect(posx+screenxsize-25-50, posy+screenysize-25-50,
              posx+screenxsize-15-50, posy+screenysize-15-50)
}

setcolour(col_white)

```

```

IF debugging DO
{
  plotf(20, my+ 15, "rpm=%6.1f target rpm=%6.1f thrust=%8.3f",
        rpm, targetrpm, thrust)
  plotf(20, my,      "Throttle=%6.3f Elevator=%6.3f Aileron=%6.3f Rudder=%6.3f",
        throttle,   elevator,   aileron,   rudder)
  plotf(20, my- 15, "cgn=   %13.3f cgw=   %13.3f cgh=   %13.3f", cgn,   cgw,   cgh)
  plotf(20, my- 30, "cgndot= %13.3f cgwdot=%13.3f cghdot=%13.3f", cgndot,cgwdot,cghdot)
  plotf(20, my- 45, "tdot=   %13.3f wdot=   %13.3f ldot=   %13.3f", tdot,  wdot,  ldot)
  plotf(20, my- 60, "ctn=  %7.3f ctw=  %7.3f cth=  %7.3f", ctn,   ctw,   cth)
  plotf(20, my- 75, "cwn=  %7.3f cww=  %7.3f cwh=  %7.3f", cwn,   cww,   cwh)
  plotf(20, my- 90, "cln=  %7.3f clw=  %7.3f clh=  %7.3f", cln,   clw,   clh)
  plotf(20, my-105, "ft=    %13.3f fw=    %13.3f fl=    %13.3f", ft,    fw,    fl)
  plotf(20, my-120, "rft=    %13.3f rfw=    %13.3f rfl=    %13.3f", rft,    rfw,    rfl)
  plotf(20, my-135, "rtdot=  %13.3f rwdot= %13.3f rldot= %13.3f", rtdot,  rwdot,  rldot)
  plotf(20, my-150, "steprate=%8.3f", steprate)

  plotf(20, 130, "tdot=%13.3f ldot=%13.3f => angle=%6.1f airspeed=%13.3f",
        tdot, ldot, atl, radius2(tdot, ldot))
  plotf(20, 115, "atl=%6.1f rdtab(atl,lifftab)=%9.3f", atl, rdtab(atl,lifftab))

}

IF plotusage DO
{ plotf(20, 20, "CPU usage = %3i%%", usage)
}

{ LET heading = - FIX (angle(ctn,ctw))
  IF heading < 0 DO heading := 360 + heading
  plotf(20, 5, "      RPM %i4 Speed %3i mph Altiude %i5 ft Heading %i3",
        FIX rpm, FIX (tdot/mpH2fps), FIX cgh, heading)
}
//updatescreen()
}

AND plotscreen() BE
{ LET mx = screenxsize / 2
  LET my = screenysize - 70

  fillsurf(col_blue)

  setcolour(col_lightcyan)

  drawstring(240, 50, done -> "Quitting", "Tiger Moth Flight Simulator")
}

```

```

drawcontrols()

setcolour(col_gray)
//moveto(mx, my)
//drawby(0, FIX(cgh/100))

setcolour(col_majenta)
//moveto(mx+200, my)
//drawby(FIX(ctn * 20.0), FIX(ctw * 20.0))

draw_artificial_horizon()

drawgroundpoints()

IF eyedir D0 plotcraft()
updatescreen()
//abort(1000)
}

AND seteyeposition1() BE
{ cetn, cetw, ceth := One, Zro, Zro
  cewn, ceww, cewh := Zro, One, Zro
  celn, celw, celh := Zro, Zro, One
  eyen, eyew, eyez := -eyedist, Zro, Zro // Relative eye position
}

AND seteyeposition() BE
{ LET FLT d1 = eyedist
  LET FLT d2 = d1 * 0.707
  LET FLT d3 = d2 / 3

  cetn, cetw, ceth := One, Zro, Zro
  cewn, ceww, cewh := Zro, One, Zro
  celn, celw, celh := Zro, Zro, One
  eyen, eyew, eyez := -eyedist, Zro, Zro // Relative eye position

UNLESS 0<=eyedir<=8 D0 eyedir := 1

IF hatdir & sdlmsecs(>)>hatmsecs+100 D0
{ eyedir := FIX(((angle(ctn, ctw)+360.0+22.5) / 45.0) & 7
  // dir = 0 heading N
  // dir = 1 heading NE
  // dir = 2 heading E

```



```

// dir = 3 heading SE
// dir = 4 heading S
// dir = 5 heading SW
// dir = 6 heading W
// dir = 7 heading NW
SWITCHON hatdir INTO
{ DEFAULT:
  CASE #b0001:                                ENDCASE // Forward
  CASE #b0011: eyedir := eyedir+1; ENDCASE // Forward right
  CASE #b0010: eyedir := eyedir+2; ENDCASE // Right
  CASE #b0110: eyedir := eyedir+3; ENDCASE // Backward right
  CASE #b0100: eyedir := eyedir+4; ENDCASE // Backward
  CASE #b1100: eyedir := eyedir+5; ENDCASE // Backward left
  CASE #b1000: eyedir := eyedir+6; ENDCASE // Left
  CASE #b1001: eyedir := eyedir+7; ENDCASE // Forward left
}
eyedir := (eyedir & 7) + 1
hatdir := 0

//writef("ctn=%9.3f ctw=%9.3f eyedir=%9.1f*n", ctn, ctw, eyedir)
//abort(1009)
}

SWITCHON eyedir INTO
{ DEFAULT:

  CASE 0: // Pilot's view
    cetn, cetw, ceth := ctn, ctw, cth
    cewn, ceww, cewh := cwn, cww, cwh
    celn, celw, celh := cln, clw, clh

    eyen, eyew, eyeh := Zro, Zro, Zro // Relative eye position
    RETURN

  CASE 1: // North
    cetn, cetw, ceth := One, Zro, Zro
    cewn, ceww, cewh := Zro, One, Zro
    celn, celw, celh := Zro, Zro, One
    eyen, eyew, eyeh := -d1, Zro, d3 // Relative eye position
    RETURN

  CASE 2: // North east
    cetn, cetw, ceth := D45, D45, Zro
    cewn, ceww, cewh := -D45, D45, Zro
    celn, celw, celh := Zro, Zro, One

```

```

    eyen, eyew, eyeh := -d2, -d2, d3 // Relative eye position
    RETURN

CASE 3: // East
    cetn, cetw, ceth := Zro, One, Zro
    cewn, ceww, cewh := -One, Zro, Zro
    celn, celw, celh := Zro, Zro, One
    eyen, eyew, eyeh := Zro, -d1, d3 // Relative eye position
    RETURN

CASE 4: // South east
    cetn, cetw, ceth := -D45, D45, Zro
    cewn, ceww, cewh := -D45, -D45, Zro
    celn, celw, celh := Zro, Zro, One
    eyen, eyew, eyeh := d2, -d2, d3 // Relative eye position
    RETURN

CASE 5: // South
    cetn, cetw, ceth := -One, Zro, Zro
    cewn, ceww, cewh := Zro, -One, Zro
    celn, celw, celh := Zro, Zro, One
    eyen, eyew, eyeh := d1, Zro, d3 // Relative eye position
    RETURN

CASE 6: // South west
    cetn, cetw, ceth := -D45, -D45, Zro
    cewn, ceww, cewh := D45, -D45, Zro
    celn, celw, celh := Zro, Zro, One
    eyen, eyew, eyeh := d2, d2, d3 // Relative eye position
    RETURN

CASE 7: // West
    cetn, cetw, ceth := Zro, -One, Zro
    cewn, ceww, cewh := One, Zro, Zro
    celn, celw, celh := Zro, Zro, One
    eyen, eyew, eyeh := Zro, d1, d3 // Relative eye position

    RETURN

CASE 8: // North west
    cetn, cetw, ceth := D45, -D45, Zro
    cewn, ceww, cewh := D45, D45, Zro
    celn, celw, celh := Zro, Zro, One
    eyen, eyew, eyeh := -d2, d2, d3 // Relative eye position
    RETURN

```

```

    }
}

AND processevents() BE WHILE getevent() SWITCHON eventtype INTO
{ DEFAULT:
    //writef("Unknown event type = %n*n", eventtype)
    LOOP

CASE sdle_keydown:
    SWITCHON capitalch(eventa2) INTO
    { DEFAULT:
        LOOP

        CASE 'A': TEST eventa2='a'
            THEN rotate( 0.1, 0.0, 0.0)
            ELSE rotate(-0.1, 0.0, 0.0)
            plotscreen()
            LOOP

        CASE 'B': TEST eventa2='b'
            THEN rotate( 0.0, 0.1, 0.0)
            ELSE rotate( 0.0, -0.1, 0.0)
            plotscreen()
            LOOP

        CASE 'C': TEST eventa2='c'
            THEN rotate( 0.0, 0.0, 0.1)
            ELSE rotate( 0.0, 0.0, -0.1)
            plotscreen()
            LOOP

        CASE 'Q': done := TRUE;
        LOOP

        CASE 'D': debugging := ~debugging;
        LOOP

        CASE 'P': stepping := ~stepping;
        LOOP

        CASE 'U': plotusage := ~plotusage;
        LOOP

        CASE 'S': enginestarted := ~enginestarted;
        LOOP

        CASE 'G': // Position aircraft on the glide path
            initposition(2)
            LOOP

        CASE 'L': // Set level flight at 3000 ft and speed 65 mph.

```

```

        initposition(3)
        LOOP

CASE 'T': // Position the aircraft ready for take off
        initposition(1)
        LOOP

CASE 'N': // Reduce eye distance
        eyedist := eyedist*5/6
        IF eyedist<60.0 DO eyedist := 60.0
        LOOP

CASE 'F': // Increase eye distance
        eyedist := eyedist*6/5
        IF eyedist > 1000.0 DO eyedist := 1000.0
        LOOP

CASE 'Z': c_trimthrottle := c_trimthrottle - 0.05
        throttle := c_trimthrottle+c_throttle
        IF throttle < 0.0 DO throttle, c_trimthrottle := 0.0, -c_throttle
        LOOP

CASE 'X': c_trimthrottle := c_trimthrottle + 0.050
        throttle := c_trimthrottle+c_throttle
        IF throttle > 1.0 DO throttle, c_trimthrottle := 1.0, 1.0-c_throttle
        LOOP

CASE ',':
CASE '<': c_trimrudder := c_trimrudder - 0.050
        rudder := c_trimrudder+c_rudder
        IF rudder < -1.0 DO rudder, c_trimrudder := -1.0, -1.0-c_rudder
        LOOP

CASE '.':
CASE '>': c_trimrudder := c_trimrudder + 0.050
        rudder := c_trimrudder+c_rudder
        IF rudder > 1.0 DO rudder, c_trimrudder := 1.0, 1.0-c_rudder
        LOOP

CASE '0': eyedir, hatdir := 0, 0;          LOOP // Pilot's view
CASE '1': hatdir, hatmsecs := #b0001, 0; LOOP // From behind
CASE '2': hatdir, hatmsecs := #b0011, 0; LOOP // From behind right
CASE '3': hatdir, hatmsecs := #b0010, 0; LOOP // From right
CASE '4': hatdir, hatmsecs := #b0110, 0; LOOP // From in front right
CASE '5': hatdir, hatmsecs := #b0100, 0; LOOP // From in front

```

```

CASE '6': hatdir, hatmsecs := #b1100, 0; LOOP // From in front left
CASE '7': hatdir, hatmsecs := #b1000, 0; LOOP // From left
CASE '8': hatdir, hatmsecs := #b1001, 0; LOOP // From behind left

CASE sdle_arrowup:
    c_trimelevator := c_trimelevator + 0.050
    elevator := c_trimelevator+c_elevator
    IF elevator > 1.0 DO elevator, c_trimelevator := 1.0, 1.0-c_elevator
    LOOP

CASE sdle_arrowdown:
    c_trimelevator := c_trimelevator - 0.050
    elevator := c_trimelevator+c_elevator
    IF elevator < -1.0 DO elevator, c_trimelevator := -1.0, -1.0-c_elevator
    LOOP

CASE sdle_arrowright:
    c_trimaileron := c_trimaileron + 0.050
    aileron := c_trimaileron+c_aileron
    IF aileron > 1.0 DO aileron, c_trimaileron := 1.0, 1.0-c_aileron
    LOOP

CASE sdle_arrowleft:
    c_trimaileron := c_trimaileron - 0.050
    aileron := c_trimaileron+c_aileron
    IF aileron < -1.0 DO aileron, c_trimaileron := -1.0, -1.0-c_aileron
    LOOP
}
LOOP

CASE sdle_joyaxismotion: // 7
{ // This currently assumes that the joystick
  // is a CyborgX.
  LET which = eventa1
  LET axis = eventa2
  LET FLT value = (FLOAT eventa3) / 32768.0
  //writef("axismotion: which=%n axis=%n value=%8.6f*n", which, axis, value)
  SWITCHON axis INTO
  { DEFAULT: LOOP
    CASE 0: c_aileron := value; // Aileron
            aileron := c_trimaileron+c_aileron
            IF aileron < -1.0 DO aileron, c_trimaileron := -1.0, -1.0-c_aileron
            IF aileron > 1.0 DO aileron, c_trimaileron := 1.0, 1.0-c_aileron
            LOOP
    CASE 1: c_elevator := -value; // Elevator

```

```

        elevator := c_trimelevator+c_elevator
        IF elevator < -1.0 DO elevator, c_trimelevator := -1.0, -1.0-c_elevator
        IF elevator > 1.0 DO elevator, c_trimelevator := 1.0, 1.0-c_elevator
        LOOP
CASE 2:  c_throttle := (1.0-value)/2.0; // Throttle
        throttle := c_trimthrottle+c_throttle
        IF throttle < 0.0 DO throttle, c_trimthrottle := 0.0, -c_throttle
        IF throttle > 1.0 DO throttle, c_trimthrottle := 1.0, 1.0-c_throttle
        LOOP
CASE 3:  c_rudder := value; // Rudder
        rudder := c_trimrudder+c_rudder
        IF rudder < -1.0 DO rudder, c_trimrudder := -1.0, -1.0-c_rudder
        IF rudder > 1.0 DO rudder, c_trimrudder := 1.0, 1.0-c_rudder
        LOOP
CASE 4:  LOOP // Right throttle
}
}

CASE sdle_joyhatmotion:
{ LET which = eventa1
  LET axis = eventa2
  LET value = eventa3

  //writef("joyhatmotion %n %n %n*n", eventa1, eventa2, eventa3)

  SWITCHON value INTO
  { DEFAULT:
    CASE #b0000: // None LOOP
    CASE #b0001: // North
    CASE #b0011: // North east
    CASE #b0010: // East
    CASE #b0110: // South east
    CASE #b0100: // South
    CASE #b1100: // South west
    CASE #b1000: // West
    CASE #b1001: // North west
      IF value>hatdir DO
        { hatdir, hatmsecs := value, sdlmsecs()
//writef("hatdir=%b4 %n msec*s*n", hatdir, hatmsecs)
        }
        LOOP
      }
}
}

CASE sdle_joybuttondown: // 10

```

```

//writef("joybuttondown %n %n %n*n", eventa1, eventa2, eventa3)
SWITCHON eventa2 INTO
{ DEFAULT: LOOP
  CASE 7: // Left rudder trim
    c_trimrudder := c_trimrudder - 0.050
    rudder := c_trimrudder+c_rudder
    IF rudder < -1.0 DO rudder, c_trimrudder := -1.0, -1.0-c_rudder
    LOOP

  CASE 8: // Right rudder trim
    c_trimrudder := c_trimrudder + 0.050
    rudder := c_trimrudder+c_rudder
    IF rudder > 1.0 DO rudder, c_trimrudder := 1.0, 1.0-c_rudder
    LOOP

  CASE 11: // Reduce eye distance
    eyedist := eyedist*5/6
    IF eyedist < 60.0 DO eyedist := 60.0
//writef("eyedist=%9.3f*n", eyedist)
    LOOP

  CASE 12: // Increase eye distance
    eyedist := eyedist*6/5
    IF eyedist > 1000.0 DO eyedist := 1000.0
//writef("eyedist=%9.3f*n", eyedist)
    LOOP

  CASE 13: // Set pilot view
    eyedir, hatdir := 0, 0; LOOP
}
LOOP

CASE sdle_joybuttonup: // 11
//writef("joybuttonup*n", eventa1, eventa2, eventa3)
LOOP

CASE sdle_quit: // 12
writef("QUIT*n");
LOOP

CASE sdle_videoresize: // 14
//writef("videoresize*n", eventa1, eventa2, eventa3)
LOOP
}

```

More to follow.

Appendix A

sdl.h

This appendix give the source of the SDL header file `cintcode/g/sdl.h`. It is mainly here so I can proof read it on my iPad.

```
/*
##### UNDER DEVELOPMENT #####

This is the header file for the SDL features

Implemented by Martin Richards (c) Sept 2012

History:
12/12/12
Added drawtriangle(3d) and drawquad(3d)

28/08/12
Started a major modification of the library.

30/05/12
Initial implementation

g_sdlbase is set in libhdr to be the first global used in the sdl library
It can be overridden by re-defining g_sdlbase after GETting libhdr.

A program wishing to use the SDL library should contain the following lines.

GET "libhdr"
MANIFEST { g_sdlbase=nnn } // Only used if the default setting of 450 in
                          // libhdr is not suitable.

GET "sdl.h"
GET "sdl.b"              // Insert the library source code
.
```

```

GET "libhdr"
MANIFEST { g_sdlbase=nnn } // Only used if the default setting of 450 in
                          // libhdr is not suitable.

GET "sdl.h"
Rest of the program
*/

GLOBAL {
// More functions will be included in due course
initsdl: g_sdlbase
mkscreen          // (title, xsize, ysize)
setcaption        // (title)
closesdl         // ()

screen           // Handle to the screen surface
format          // Handle to the screen format, used by eg setcolour

lefts           // Used by drawtriangle and drawquad
leftds         // Used by drawtriangle3d and drawquad3d
rights         // Used by drawtriangle and drawquad
rightds        // Used by drawtriangle3d and drawquad3d
depthscreen    // Used by drawtriangle3d and drawquad3d
               // holding the depth of a drawn pixel

miny           // Used by drawtriangle(3d) and drawquad(3d)
maxy           // Used by drawtriangle(3d) and drawquad(3d)

joystick

screenxsize
screenysize
colour         // Current colour for screen
maprgb        // (r, g, b) create colour for current screen format

resizescreen  // (xsize, ysize)
setcolour     // (colour) sets colour

currx         // Coords of latest point drawn, possibly off screen
curry
currz

prevdrawn    // = TRUE if actually drawn

mousex        // Mouse state set by getmousestate
mousey

```

mousebuttons

```

eventtype          // Event type set by getevent()
eventa1
eventa2
eventa3
eventa4
eventa5

mksurface          // (width, height, key)
freesurface        // (surf)
selectsurface      // (surf, xsize, ysize)
currsurf           // Currently selected surface for drawing
currxsize          // its width
currysize          // its height
setcolourkey       // (col)

drawpoint          // (x, y) equivalent to drawfillrect(x,y,1,1)
drawpoint3d        // (x, y, z)
moveto             // (x, y) set (currx, curry) to (x,y)
moveby            // (dx, dy) set (currx, curry) to (currx+dx, curry+dy)
drawto            // (x, y) in colour from (currx, curry) to (x,y)
drawby            // (dx, dy) in colour from (currx, curry) to (currx+dx,curry+dy)

moveto3d           // (x,y,z) set (currx,curry,currz) to (x,y,z)
moveby3d           // (dx,dy,dz) set (currx,curry,currz) to (currx+dx,curry+dy,curry+dz)
drawto3d           // (x,y,z) draw (currx,curry,currz) to (x,y,z)
drawby3d           // (dx,dy,dz) draw (currx,curry,currz) to (currx+dx,curry+dy)

drawquad           // (x1,y1,x2,y2,x3,y3,x4,y4) draw a filled quadrilateral
drawtriangle       // (x1,y1,x2,y2,x3,y3) draw a filled triangle
setlims            // used by drawtriangle and drawquad (sets lefts and rights)
drawquad3d         // (x1,y1,z1,x2,y2,z2,x3,y3,z3,x4,y4,z4) draw a filled 3D quadrilateral
drawtriangle3d     // (x1,y1,z1,x2,y2,z2,x3,y3,z3) draw a filled 3D triangle
setlims3d          // used by drawtriangle3d and drawquad3d (sets lefts, rights, leftds,

drawstring         // (str)
drawcircle         // (ox, oy, r)
drawrect           // (x,y,w,h)
drawellipse        // (ox, oy, rx, ry)
drawfillellipse    // (ox, oy, rx, ry)
drawroundrect      // (x,y,w,h,r) rect with rounded corners
drawfillroundrect  // (x,y,w,h,r) rect with rounded corners
drawfillcircle     // (ox, oy, r)
drawfillrect       // (x,y,w,h)

```

```

fillsurf          // (surf)
movesurf          // (surf, dx, dy) move entire surface filling vacated pixels with colour
                  // eg movesurf(screen, -1, 0) move the screen left by one pixel

blitsurf          // (src, dsr, x, y)
blitsurfrect      // (src, sx, sy, sw, sh, dsr, dx, dy)

getmousestate     // set (mousex, mousey, buttons)
getevent          // sets event state

sdlldelay         // (msecs) using the SDL delay mechanism
sdlmsecs          // () returns msecs since start of run

hidecursor        // ()
showcursor        // ()
updatescreen      // () display the current screen

plotf             // (x, y, format, args...)
plotfstr          // Used by plotf
}

MANIFEST {
// ops used in calls of the form: sys(Sys_sdl, op,...)
// These should work when using a properly configured BCPL Cintcode system
// running under Linux, Windows or or OSX provided the SDL libraries have been
// installed.
sdl_avail=0
sdl_init          // initialise SDL with everything
sdl_setvideomode  // width, height, bbp, flags
sdl_quit          // Shut down SDL
sdl_locksurface   // surf
sdl_unlocksurface // surf
sdl_getsurfaceinfo // surf, and a pointer to [flag, format, w, h, pitch, pixels]
sdl_getfmtinfo    // fmt, and a pointer to [palette, bitspp, bytespp,
                  // rloss, rshift, gloss, gshift, blossom, bshift, aloss, ashift,
                  // colorkey, alpha]
sdl_geterror      // str -- fill str with BCPL string for the latest SDL error
sdl_updaterect    // surf, left, top, right, bottom
sdl_loadbmp       // filename of a .bmp image
sdl_blitsurface   // src, srcrect, dest, destrect
sdl_setcolourkey  // surf, flags, colorkey
sdl_freesurface   // surf
sdl_setalpha      // surf, flags, alpha
sdl_imgload       // filename -- using the SDL_image library

```

```

sdl_delay          // msec -- the SDL delay function
sdl_flip           // surf -- Double buffered update of the screen
sdl_displayformat // surf -- convert surf to display format
sdl_waitevent      // pointer to [type, args, ... ] to hold details of the next event
                  // return 0 if no events available
sdl_pollevent      // pointer to [type, args, ... ] to hold details of the next event
                  // return 0 if no events available
sdl_getmousestate // pointer to [x, y] returns bit pattern of buttons currently pressed
sdl_loadwav        // file, spec, buff, len
sdl_freewav        // buffer

sdl_wm_setcaption // string
sdl_videoinfo     // v => [ flags, blit_fill, video_mem, vfmt]
sdl_maprgb        // format, r, g, b
sdl_drawline      //27
sdl_drawhline     //28
sdl_drawvline     //29
sdl_drawcircle    //30
sdl_drawrect      //31
sdl_drawpixel     //32
sdl_drawellipse   //33
sdl_drawfillellipse //34
sdl_drawround     //35
sdl_drawfillround //36
sdl_drawfillcircle //37
sdl_drawfillrect  //38

sdl_fillrect      //39
sdl_fillsurf      //40

// Joystick functions
sdl_numjoysticks //41 (index)
sdl_joystickopen // 42 (index) => joy
sdl_joystickclose // 43 (index)
sdl_joystickname // 44 (index)
sdl_joysticknumaxes // 45 (joy)
sdl_joysticknumbuttons // 46 (joy)
sdl_joysticknumballs // 47 (joy)
sdl_joysticknumhats // 48 (joy)

sdl_joystickeventstate //49 sdl_enable=1 or sdl_ignore=0
sdl_getticks           //50 () => msec since initialisation

sdl_showcursor        //51

```

```
sdl_hidecursor          //52
sdl_mksurface           //53
sdl_setcolourkey       //54

sdl_joystickgetbutton  //55
sdl_joystickgetaxis    //56
sdl_joystickgetball    //57
sdl_joystickgethat     //58

// more to come ...

// SDL events
sdl_ignore              = 0
sdl_enable              = 1 // eg enable joystick events

sdle_active             = 1 // window gaining or losing focus
sdle_keydown           = 2 // => mod ch
sdle_keyup             = 3 // => mod ch
sdle_mousemotion       = 4 // => x y
sdle_mousebuttondown  = 5 // => buttonbits
sdle_mousebuttonup    = 6 // => buttonbits
sdle_joyaxismotion     = 7
sdle_joyballmotion    = 8
sdle_joyhatmotion     = 9
sdle_joybuttondown    = 10
sdle_joybuttonup      = 11
sdle_quit              = 12
sdle_syswmevent       = 13
sdle_videoresize      = 14
sdle_userevent        = 15

sdle_arrowup          = 273
sdle_arrowdown        = 274
sdle_arrowright       = 275
sdle_arrowleft        = 276

sdl_init_everything = #xFFFF

sdl_SWSURFACE = #x00000000 // Surface is in system memory
sdl_HWSURFACE = #x00000001 // Surface is in video memory

sdl_ANYFORMAT = #x10000000 // Allow any video depth/pixel-format
sdl_HWPALETTE = #x20000000 // Surface has exclusive palette
sdl_DOUBLEBUF = #x40000000 // Set up double-buffered video mode
sdl_FULLSCREEN = #x80000000 // Surface is a full screen display
```

```
sdl_OPENGL      = #x00000002 // Create an OpenGL rendering context
sdl_OPENGLBLIT = #x0000000A // Create an OpenGL rendering context and use it for blitting
sdl_RESIZABLE  = #x00000010 // This video mode may be resized
sdl_NOFRAME    = #x00000020 // No window caption or edge frame
}
```

Appendix B

sdl.b

This appendix give the BCPL source of the SDL library `cintcode/g/sdl.b`. It is mainly here so I can proof read it on my iPad.

```
/*  
##### UNDER DEVELOPMENT #####
```

```
This library provides some functions that interface with the SDL  
Graphics library.
```

```
Implemented by Martin Richards (c) September 2012
```

```
Change history:
```

```
26/08/12  
Initial implementation.
```

It should typically be included as a separate section for programs that need it. Such programs typically have the following structure.

```
GET "libhdr"  
MANIFEST { g_sdlbase=nnn } // Only used if the default setting of 450 in  
                          // libhdr is not suitable.  
  
GET "sdl.h"  
GET "sdl.b"              // Insert the library source code  
  
.  
GET "libhdr"  
MANIFEST { g_sdlbase=nnn } // Only used if the default setting of 450 in  
                          // libhdr is not suitable.  
  
GET "sdl.h"  
Rest of the program
```



```

*/

LET initsdl() = VALOF
{ LET mes = VEC 256/bytesperword

  IF sys(Sys_sdl, sdl_init, sdl_init_everything) DO
  { sys(Sys_sdl, sdl_geterror, mes)
    writef("Unable to initialise SDL: %s*n", mes)
    RESULTIS FALSE
  }

// writef("Number of joysticks %2i*n", sys(Sys_sdl, sdl_numjoysticks))
joystick := sys(Sys_sdl, sdl_joystickopen, 0)
// writef("Number of axis      %2i*n", sys(Sys_sdl, sdl_joysticknumaxes, joystick))
// writef("Number of buttons   %2i*n", sys(Sys_sdl, sdl_joysticknumbuttons, joystick))

  lefts, rights := 0, 0
  leftds, rightds := 0, 0
  depthscreen := 0

  // Successful
  RESULTIS TRUE
}

AND mkscreen(title, xsize, ysize) = VALOF
{ // Create a screen surface with given title and size
  LET mes = VEC 256/bytesperword

  screenxsize, screenysize := xsize, ysize

  screen := sys(Sys_sdl, sdl_setvideomode, screenxsize, screenysize, 32, sdl_SWSURFACE)

  UNLESS screen DO
  { sys(Sys_sdl, sdl_geterror, mes)
    writef("Unable to set video mode: %s*n", mes)
    RESULTIS 0
  }

  { // Surface info structure
    LET flags, fmt, w, h, pitch, pixels, cliprect, refcount =
      0, 0, 0, 0, 0, 0, 0, 0
    sys(Sys_sdl, sdl_getsurfaceinfo, screen, @flags)

    format := fmt
  }
}

```

```

    setcaption(title)
    selectsurface(screen, xsize, ysize)
}

AND maprgb(r, g, b) = sys(Sys_sdl, sdl_maprgb, format, r, g, b)

AND setcaption(title) BE sys(Sys_sdl, sdl_wm_setcaption, title, 0)

AND closesdl() BE
{ IF lefts DO freevec(lefts)
  IF rights DO freevec(rights)
  IF leftds DO freevec(leftds)
  IF rightds DO freevec(rightds)
  IF depthscreen DO freevec(depthscreen)
  sys(Sys_sdl, sdl_quit)
}

AND setcolour(col) BE colour, prevdrawn := col, FALSE

AND setcolourkey(surf, col) BE sys(Sys_sdl, sdl_setcolourkey, surf, col)

AND selectsurface(surf, xsize, ysize) BE
  currsurf, currxsize, currysize := surf, xsize, ysize

AND moveto(x, y) BE
  currx, curry, prevdrawn := x, y, FALSE

AND moveto3d(x, y, z) BE
  currx, curry, currz, prevdrawn := x, y, z, FALSE

AND drawto1(x, y) BE
{ LET mx, my = ?, ?
  IF x<0 & currx<0      |
    y<0 & curry<0      |
    x>=currxsize & currx>=currxsize |
    y>=currysize & curry>=currysize DO
    { currx, curry, prevdrawn := x, y, FALSE
      RETURN
    }
}

UNLESS prevdrawn DO drawpoint(currx, curry)

mx := (x+currx)/2
my := (y+curry)/2

```

```

TEST (mx=currx | mx=x) & (my=curry | my=y)
THEN drawpoint(x, y)
ELSE { drawto(mx, my)
      drawto(x, y)
    }
}

AND drawpoint(x, y) BE
{ // (0, 0) is the bottom left point on the surface
  prevdrawn := FALSE
  IF 0<=x<currxsize & 0<=y<currysize DO
  { sys(Sys_sdl, sdl_fillrect, currsurf, x, currysize-y, 1, 1, colour)
    prevdrawn := TRUE
  }
  currx, curry := x, y
}

AND drawpoint3d(x, y, z) BE
{ // (0, 0) is the bottom left point on the surface
  prevdrawn := FALSE
  //IF y<2 DO writef("drawpoint3d: (%i3,%i3,%i3)*n", x,y,z)
  //IF y<0 DO abort(1234)
  IF 0<=x<currxsize & 0<=y<currysize DO
  { LET p = @(depthscreen!(x+y*currxsize))
    IF z<!p DO
    { !p := z
      sys(Sys_sdl, sdl_fillrect, currsurf, x, currysize-y, 1, 1, colour)
      prevdrawn := TRUE
    }
  }
  currx, curry, currz := x, y, z
}

AND moveby(dx, dy) BE moveto(currx+dx, curry+dy)
AND drawby(dx, dy) BE drawto(currx+dx, curry+dy)

AND moveby3d(dx, dy, dz) BE moveto3d(currx+dx, curry+dy, currz+dz)
AND drawby3d(dx, dy, dz) BE drawto3d(currx+dx, curry+dy, currz+dz)

AND getevent() = VALOF
{ //writef("Calling pollevent*n")
  RESULTIS sys(Sys_sdl, sdl_pollevent, @eventtype)
}

```

```

AND slddelay(msecs) BE // Delay using the SDL delay mechanism
  sys(Sys_sdl, sdl_delay, msecs)

AND sldmsecs() = // returns msecs since start of run
  sys(Sys_sdl, sdl_getticks)

AND hidecursor() = sys(Sys_sdl, sdl_hidecursor)

AND showcursor() = sys(Sys_sdl, sdl_showcursor)

AND updatescreen() BE // Display the screen
  sys(Sys_sdl, sdl_flip, screen)

AND mksurface(w, h) = VALOF
{ //writef("mksurface: w=%n h=%n*n", w, h)
  RESULTIS sys(Sys_sdl, sdl_mksurface, format, w, h)
}

AND freesurface(surf) BE sys(Sys_sdl, sdl_freesurface, surf)

AND blitsurf(src, dst, x, y) BE
{ // Blit the source surface to the specified position
  // in the destination surface
  LET dx, dy, dw, dh = x, curysize-y-1, 0, 0
  sys(Sys_sdl, sdl_blitsurface, src, 0, dst, @dx)
}

AND blitsurfrect(src, srcrect, dst, x, y) BE
{ // Blit the specified rectangle from the source surface to
  // the specified position in the destination surface
  LET dx, dy, dw, dh = x, curysize-y-1, 0, 0
  sys(Sys_sdl, sdl_blitsurface, src, srcrect, dst, @dx)
}

AND fillsurf(col) BE
  sys(Sys_sdl, sdl_fillsurf, currsurf, col)

AND drawch(ch) BE TEST ch='*n'
THEN { currx, curry := 10, curry-14
  }
ELSE { FOR line = 0 TO 11 DO
  write_ch_slice(currx, curry+11-line, ch, line)
  currx := currx+9
}

```

```

}

AND write_ch_slice(x, y, ch, line) BE
{ // Writes the horizontal slice of the given character.
  // Character are 8x12
  LET cx, cy = currx, curry
  LET i = (ch&#x7F) - '*s'
  LET charbase = TABLE // Still under development !!!
    #X00000000, #X00000000, #X00000000, // space
    #X18181818, #X18180018, #X18000000, // !
    #X66666600, #X00000000, #X00000000, // "
    #X6666FFFF, #X66FFFF66, #X66000000, // #
    #X7EFFFDFE, #X7F1B1BFF, #X7E000000, // $
    #X06666C0C, #X18303666, #X60000000, // %
    #X3078C8C8, #X7276DCCC, #X76000000, // &
    #X18181800, #X00000000, #X00000000, // '
    #X18306060, #X60606030, #X18000000, // (
    #X180C0606, #X0606060C, #X18000000, // )
    #X00009254, #X38FE3854, #X92000000, // *
    #X00000018, #X187E7E18, #X18000000, // +
    #X00000000, #X00001818, #X08100000, // ,
    #X00000000, #X007E7E00, #X00000000, // -
    #X00000000, #X00000018, #X18000000, // .
    #X06060C0C, #X18183030, #X60600000, // /
    #X386CC6C6, #XC6C6C66C, #X38000000, // 0
    #X18387818, #X18181818, #X18000000, // 1
    #X3C7E6206, #X0C18307E, #X7E000000, // 2
    #X3C6E4606, #X1C06466E, #X3C000000, // 3
    #X1C3C3C6C, #XCCFFFF0C, #X0C000000, // 4
    #X7E7E6060, #X7C0E466E, #X3C000000, // 5
    #X3C7E6060, #X7C66667E, #X3C000000, // 6
    #X7E7E0606, #X0C183060, #X40000000, // 7
    #X3C666666, #X3C666666, #X3C000000, // 8
    #X3C666666, #X3E060666, #X3C000000, // 9
    #X00001818, #X00001818, #X00000000, // :
    #X00001818, #X00001818, #X08100000, // ;
    #X00060C18, #X30603018, #X0C060000, // <
    #X00000000, #X7C007C00, #X00000000, // =
    #X00603018, #X0C060C18, #X30600000, // >
    #X3C7E0606, #X0C181800, #X18180000, // ?
    #X7E819DA5, #XA5A59F80, #X7F000000, // @
    #X3C7EC3C3, #XFFFFC3C3, #XC3000000, // A
    #XFEFFC3FE, #XFEC3C3FF, #XFE000000, // B
    #X3E7FC3C0, #XC0C0C37F, #X3E000000, // C
    #XFCFEC3C3, #XC3C3C3FE, #XFC000000, // D

```

```

#XFFFC0FC, #XFCC0C0FF, #XFF000000, // E
#XFFFC0FC, #XFCC0C0C0, #XC0000000, // F
#X3E7FE1C0, #XCFCFE3FF, #X7E000000, // G
#XC3C3C3FF, #XFFC3C3C3, #XC3000000, // H
#X18181818, #X18181818, #X18000000, // I
#X7F7F0C0C, #X0C0CCFC, #X78000000, // J
#XC2C6CCD8, #XF0F8CCC6, #XC2000000, // K
#XC0C0C0C0, #XC0C0C0FE, #XFE000000, // L
#X81C3E7FF, #XDBC3C3C3, #XC3000000, // M
#X83C3E3F3, #XDBCFC7C3, #XC1000000, // N
#X7EFFF3C3, #XC3C3C3FF, #X7E000000, // O
#XFEFFC3C3, #XFFFECC0C, #XC0000000, // P
#X7EFFF3C3, #XDBCFC7FE, #X7D000000, // Q
#XFEFFC3C3, #XFFFECCC6, #XC3000000, // R
#X7EC3C0C0, #X7E0303C3, #X7E000000, // S
#XFFFF1818, #X18181818, #X18000000, // T
#XC3C3C3C3, #XC3C3C37E, #X3C000000, // U
#X81C3C366, #X663C3C18, #X18000000, // V
#XC3C3C3C3, #XDBFFE7C3, #X81000000, // W
#XC3C3666C, #X183C66C3, #XC3000000, // X
#XC3C36666, #X3C3C1818, #X18000000, // Y
#XFFFF060C, #X183060FF, #XFF000000, // Z
#X78786060, #X60606060, #X78780000, // [
#X60603030, #X18180C0C, #X06060000, // \
#X1E1E0606, #X06060606, #X1E1E0000, // ]
#X10284400, #X00000000, #X00000000, // ^
#X00000000, #X00000000, #X00FFFF00, // _
#X30180C00, #X00000000, #X00000000, // `
#X00007AFE, #XC6C6C6FE, #X7B000000, // a
#XC0C0DCFE, #XC6C6C6FE, #XDC000000, // b
#X00007CFE, #XC6C0C6FE, #X7C000000, // c
#X060676FE, #XC6C6C6FE, #X76000000, // d
#X00007CFE, #XC6FCC0FE, #X7C000000, // e
#X000078FC, #XC0F0F0C0, #XC0000000, // f
#X000076FE, #XC6C6C6FE, #X7606FE7C, // g
#XC0C0DCFE, #XC6C6C6C6, #XC6000000, // h
#X18180018, #X18181818, #X18000000, // i
#XC0C0000C, #XC0C0C7C, #X38000000, // j
#X00C0C6CC, #XD8F0F8CC, #XC6000000, // k
#X00606060, #X6060607C, #X38000000, // l
#X00006CFE, #XD6D6D6D6, #XD6000000, // m
#X0000DCFE, #XC6C6C6C6, #XC6000000, // n
#X00007CFE, #XC6C6C6FE, #X7C000000, // o
#X00007CFE, #XC6FEFCC0, #XC0000000, // p
#X00007CFE, #XC6FE7E06, #X06000000, // q

```

```

#X0000DCFE, #XC6C0C0C0, #XC0000000, // r
#X00007CFE, #XC07C06FE, #X7C000000, // s
#X0060F8F8, #X6060607C, #X38000000, // t
#X0000C6C6, #XC6C6C6FE, #X7C000000, // u
#X0000C6C6, #X6C6C6C38, #X10000000, // v
#X0000D6D6, #XD6D6D6FE, #X6C000000, // w
#X0000C6C6, #X6C386CC6, #XC6000000, // x
#X0000C6C6, #XC6C6C67E, #X7606FE7C, // y
#X00007EFE, #X0C3860FE, #XFC000000, // z
#X0C181808, #X18301808, #X18180C00, // {
#X18181818, #X18181818, #X18181800, // |
#X30181810, #X180C1810, #X18183000, // }
#X00000070, #XD1998B0E, #X00000000, // ~
#XAA55AA55, #XAA55AA55, #XAA55AA55 // rubout

```

```
IF i>=0 DO charbase := charbase + 3*i
```

```
{ LET col = colour
```

```
LET w = VALOF SWITCHON line INTO
```

```
{ CASE 0: RESULTIS charbase!0>>24
```

```
CASE 1: RESULTIS charbase!0>>16
```

```
CASE 2: RESULTIS charbase!0>> 8
```

```
CASE 3: RESULTIS charbase!0
```

```
CASE 4: RESULTIS charbase!1>>24
```

```
CASE 5: RESULTIS charbase!1>>16
```

```
CASE 6: RESULTIS charbase!1>> 8
```

```
CASE 7: RESULTIS charbase!1
```

```
CASE 8: RESULTIS charbase!2>>24
```

```
CASE 9: RESULTIS charbase!2>>16
```

```
CASE 10: RESULTIS charbase!2>> 8
```

```
CASE 11: RESULTIS charbase!2
```

```
}
```

```
IF ((w >> 7) & 1) = 1 DO drawpoint(x, y)
```

```
IF ((w >> 6) & 1) = 1 DO drawpoint(x+1, y)
```

```
IF ((w >> 5) & 1) = 1 DO drawpoint(x+2, y)
```

```
IF ((w >> 4) & 1) = 1 DO drawpoint(x+3, y)
```

```
IF ((w >> 3) & 1) = 1 DO drawpoint(x+4, y)
```

```
IF ((w >> 2) & 1) = 1 DO drawpoint(x+5, y)
```

```
IF ((w >> 1) & 1) = 1 DO drawpoint(x+6, y)
```

```
IF (w & 1) = 1 DO drawpoint(x+7, y)
```

```
}
```

```
currx, curry := cx, cy
```

```
}
```

```

AND drawstring(x, y, s) BE
{ moveto(x, y)
  FOR i = 1 TO s%0 DO drawch(s%i)
}

AND plotf(x, y, form, a, b, c, d, e, f, g, h) BE
{ LET oldwrch = wrch
  LET s = VEC 256/bytesperword
  plotfstr := s
  plotfstr%0 := 0
  wrch := plotwrch
  writef(form, a, b, c, d, e, f, g, h)
  wrch := oldwrch
  drawstring(x, y, plotfstr)
}

AND plotwrch(ch) BE
{ LET strlen = plotfstr%0 + 1
  plotfstr%strlen := ch
  plotfstr%0 := strlen
}

AND drawto(x, y) BE
{ // This is Bresenham's algorithm
  LET dx = ABS(x-currx)
  AND dy = ABS(y-curry)
  LET sx = currx<x -> 1, -1
  LET sy = curry<y -> 1, -1
  LET err = dx-dy
  LET e2 = ?

  { drawpoint(currx, curry)
    IF currx=x & curry=y RETURN
    e2 := 2*err
    IF e2 > -dy DO
    { err := err - dy
      currx := currx+sx
    }
    IF e2 < dx DO
    { err := err + dx
      curry := curry + sy
    }
  } REPEAT
}

```



```

AND drawto3d(x, y, z) BE
{ // This is Bresenham's algorithm
  LET dx = ABS(x-currx)
  AND dy = ABS(y-curry)
  LET sx = currx<x -> 1, -1
  LET sy = curry<y -> 1, -1
  LET py = curry<y -> currxsize, -currxsize
  LET x0, y0, z0 = currx, curry, currz
  LET err = dx-dy
  LET e2 = ?

  //IF y<0 DO
  //{{ writef("drawto3d: x=%n y=%n z=%n*n", x,y,z)
  // abort(1237)
  //}}
  { drawpoint3d(currx,curry,currz)

    IF currx=x & curry=y RETURN
    e2 := 2*err
    IF e2 > -dy DO
    { err := err - dy
      currx := currx+sx
    }
    IF e2 < dx DO
    { err := err + dx
      curry := curry + sy
    }
    TEST dx>=dy
    THEN currz := z0 + muldiv(z-z0, currx-x0, x-x0)
    ELSE currz := z0 + muldiv(z-z0, curry-y0, y-y0)
  } REPEAT
}

AND setlims(x, y) BE
{ // This is used by drawtriangle and is based on Bresenham's algorithm
  LET dx = ABS(x-currx)
  AND dy = ABS(y-curry)
  LET sx = currx<x -> 1, -1
  LET sy = curry<y -> 1, -1
  LET err = dx-dy

  IF curry<miny DO miny := curry
  IF curry>maxy DO maxy := curry

  { LET e2 = 2*err

```

```

IF currx < lefts!curry DO lefts!curry := currx
IF currx > rights!curry DO rights!curry := currx

IF currx=x & curry=y RETURN

IF e2 > -dy DO
{ err := err - dy
  currx := currx + sx
}
IF e2 < dx DO
{ err := err + dx
  curry := curry + sy
}
} REPEAT
}

AND alloc2dvecs() BE UNLESS lefts DO
{ lefts := getvec(currysize-1)
  rights := getvec(currysize-1)
  FOR i = 0 TO currysize-1 DO
    lefts!i, rights!i := maxint, minint
  }

AND drawquad(x1,y1,x2,y2,x3,y3,x4,y4) BE
{ alloc2dvecs()

  miny, maxy := maxint, minint

  moveto(x1,y1)
  setlims(x2,y2)
  setlims(x3,y3)
  setlims(x4,y4)
  setlims(x1,y1)

  FOR y = miny TO maxy DO
  { moveto(lefts!y, y)
    drawto(rights!y, y)
    lefts!y, rights!y := maxint, minint
  }
  moveto(x1,y1)
}

AND drawtriangle(x1,y1,x2,y2,x3,y3) BE
{ alloc2dvecs()

```

```

miny, maxy := maxint, minint

moveto(x1,y1)
setlims(x2,y2)
setlims(x3,y3)
setlims(x1,y1)

FOR y = miny TO maxy DO
{ moveto(lefts!y, y)
  drawto(rights!y, y)
  lefts!y, rights!y := maxint, minint
}
moveto(x1,y1)
}

AND setlims3d(x, y, z) BE
{ // This is used by drawtriangle3d and drawquad3d
  // It is based on Bresenham's algorithm
  LET dx = ABS(x-currx)
  AND dy = ABS(y-curry)
  LET x0, y0, z0 = currx, curry, currz
  LET sx = currx<x -> 1, -1
  LET sy = curry<y -> 1, -1
  LET err = dx-dy

  { LET e2 = 2*err

    IF 0<=curry<currysize DO
    { IF curry<miny DO miny := curry
      IF curry>maxy DO maxy := curry

      IF currx <= lefts!curry DO
      { lefts!curry := currx
        //IF leftds!curry > currz DO // Bug???
        leftds!curry := currz
      }
      IF currx >= rights!curry DO
      { rights!curry := currx
        //IF rightds!curry > currz DO // Bug???
        rightds!curry := currz
      }
    }
  }
  IF currx=x & curry=y RETURN

```

```

IF e2 > -dy DO
{ err := err - dy
  currx := currx + sx
  IF dx>=dy DO
  { currz := z0 + muldiv(z-z0, currx-x0, x-x0)
  }
}
IF e2 < dx DO
{ err := err + dx
  curry := curry + sy
  IF dy>dx DO
  { currz := z0 + muldiv(z-z0, curry-y0, y-y0)
  }
}
} REPEAT
}

AND alloc3dvecs() BE
{ UNLESS lefts DO
  { lefts := getvec(currysize-1)
    rights := getvec(currysize-1)
    FOR y = 0 TO currysize-1 DO
      lefts!y, rights!y := maxint, minint
    }
}

UNLESS leftds DO
{ leftds := getvec(currysize-1)
  rightds := getvec(currysize-1)
  FOR y = 0 TO currysize-1 DO
    leftds!y, rightds!y := maxint, maxint
  }
}

UNLESS depthscreen DO
{ depthscreen := getvec(currxsize*currysize-1)
  FOR i = 0 TO currxsize*currysize-1 DO
    depthscreen!i := maxint
  }
}

AND drawquad3d(x1,y1,z1, x2,y2,z2, x3,y3,z3, x4,y4,z4) BE
{ // Draw a filled convex quadralateral
  // The points are assumed to be coplanar
  alloc3dvecs()

```

```

//IF x1=400 & y1=7 DO
//{ writef("drawquad3d: x1=%i5 y1=%i5 z1=%i5*n", x1,y1,z1)
// writef("drawquad3d: x2=%i5 y2=%i5 z2=%i5*n", x2,y2,z2)
// writef("drawquad3d: x3=%i5 y3=%i5 z3=%i5*n", x3,y3,z3)
// writef("drawquad3d: x4=%i5 y4=%i5 z4=%i5*n", x4,y4,z4)
// abort(1235)
//}
  miny, maxy := maxint, minint

  moveto3d (x1,y1,z1)
  setlims3d(x2,y2,z2)
  setlims3d(x3,y3,z3)
  setlims3d(x4,y4,z4)
  setlims3d(x1,y1,z1)

//IF miny<0 DO
//{ writef("drawquad3d: miny=%n maxy=%n*n", miny, maxy)
// abort(1236)
//}
  FOR y = miny TO maxy DO
  { moveto3d( lefts!y, y, leftds!y)
    drawto3d(rights!y, y, rightds!y)

    lefts!y, rights!y := maxint, minint
    leftds!y, rightds!y := maxint, maxint
  }
  moveto3d(x1,y1,z1)
}

AND drawtriangle3d(x1,y1,z1, x2,y2,z2, x3,y3,z3) BE
{ alloc3dvecs()

  miny, maxy := maxint, minint

  moveto3d (x1,y1,z1)
  setlims3d(x2,y2,z2)
  setlims3d(x3,y3,z3)
  setlims3d(x1,y1,z1)

  FOR y = miny TO maxy DO
  { moveto3d( lefts!y, y, leftds!y)
    drawto3d(rights!y, y, rightds!y)

    lefts!y, rights!y := maxint, minint
    leftds!y, rightds!y := maxint, maxint
  }
}

```

```

    }
    moveto3d(x1,y1,z1)
}

```

```

AND drawrect(x0, y0, x1, y1) BE
{ LET xmin, xmax = x0, x1
  LET ymin, ymax = y0, y1
  IF xmin>xmax DO xmin, xmax := x1, x0
  IF ymin>ymax DO ymin, ymax := y1, y0

```

```

  FOR x = xmin TO xmax DO
  { drawpoint(x, ymin)
    drawpoint(x, ymax)
  }
  FOR y = ymin+1 TO ymax-1 DO
  { drawpoint(xmin, y)
    drawpoint(xmax, y)
  }
  currx, curry := x0, y0
}

```

```

AND drawfillrect(x0, y0, x1, y1) BE
{ LET xmin, xmax = x0, x1
  LET ymin, ymax = y0, y1
  IF xmin>xmax DO xmin, xmax := x1, x0
  IF ymin>ymax DO ymin, ymax := y1, y0

```

```

  sys(Sys_sdl, sdl_fillrect, currsurf,
      xmin, currrsize-ymax, xmax-xmin+1, ymax-ymin+1, colour)
/*
  FOR x = xmin TO xmax FOR y = ymin TO ymax DO
  { drawpoint(x, y)
  }
*/
  currx, curry := x0, y0
}

```

```

AND drawroundrect(x0,y0,x1,y1,radius) BE
{ LET xmin, xmax = x0, x1
  LET ymin, ymax = y0, y1
  LET r = radius
  LET f, ddf_x, ddf_y, x, y = ?, ?, ?, ?, ?

  IF xmin>xmax DO xmin, xmax := x1, x0
  IF ymin>ymax DO ymin, ymax := y1, y0

```

```

IF r<0 DO r := 0
IF r+r>xmax-xmin DO r := (xmax-xmin)/2
IF r+r>ymin-ymin DO r := (ymin-ymin)/2

FOR x = xmin+r TO xmax-r DO
{ drawpoint(x, ymin)
  drawpoint(x, ymax)
}
FOR y = ymin+r+1 TO ymax-r-1 DO
{ drawpoint(xmin, y)
  drawpoint(xmax, y)
}
// Now draw the rounded corners
// This is commonly called Bresenham's circle algorithm since it
// is derived from Bresenham's line algorithm.
f := 1 - r
ddf_x := 1
ddf_y := -2 * r
x := 0
y := r

drawpoint(xmax, ymin+r)
drawpoint(xmin, ymin+r)
drawpoint(xmax, ymax-r)
drawpoint(xmin, ymax-r)

WHILE x<y DO
{ // ddf_x = 2*x + 1
  // ddf_y = -2 * y
  // f = x*x + y*y - radius*radius + 2*x - y + 1
  IF f>=0 DO
  { y := y-1
    ddf_y := ddf_y + 2
    f := f + ddf_y
  }
  x := x+1
  ddf_x := ddf_x + 2
  f := f + ddf_x
  drawpoint(xmax-r+x, ymax-r+y) // octant 2
  drawpoint(xmin+r-x, ymax-r+y) // Octant 3
  drawpoint(xmax-r+x, ymin+r-y) // Octant 7
  drawpoint(xmin+r-x, ymin+r-y) // Octant 6
  drawpoint(xmax-r+y, ymax-r+x) // Octant 1
  drawpoint(xmin+r-y, ymax-r+x) // Octant 4
  drawpoint(xmax-r+y, ymin+r-x) // Octant 8
}

```

```

    drawpoint(xmin+r-y, ymin+r-x) // Octant 5
}

currx, curry := x0, y0
}

AND drawfillroundrect(x0, y0, x1, y1, radius) BE
{ LET xmin, xmax = x0, x1
  LET ymin, ymax = y0, y1
  LET r = radius
  LET f, ddf_x, ddf_y, x, y = ?, ?, ?, ?, ?
  LET lastx, lasty = 0, 0

  IF xmin>xmax DO xmin, xmax := x1, x0
  IF ymin>ymax DO ymin, ymax := y1, y0
  IF r<0 DO r := 0
  IF r+r>xmax-xmin DO r := (xmax-xmin)/2
  IF r+r>ymax-ymin DO r := (ymax-ymin)/2

  FOR x = xmin TO xmax FOR y = ymin+r TO ymax-r DO
  { drawpoint(x, y)
    drawpoint(x, y)
  }

  // Now draw the rounded corners
  // This is commonly called Bresenham's circle algorithm since it
  // is derived from Bresenham's line algorithm.
  f := 1 - r
  ddf_x := 1
  ddf_y := -2 * r
  x := 0
  y := r

  drawpoint(xmax, ymin+r)
  drawpoint(xmin, ymin+r)
  drawpoint(xmax, ymax-r)
  drawpoint(xmin, ymax-r)

  WHILE x<y DO
  { // ddf_x = 2*x + 1
    // ddf_y = -2 * y
    // f = x*x + y*y - radius*radius + 2*x - y + 1
    IF f>=0 DO
    { y := y-1
      ddf_y := ddf_y + 2

```



```

    f := f + ddf_y
  }
  x := x+1
  ddf_x := ddf_x + 2
  f := f + ddf_x
  drawpoint(xmax-r+x, ymax-r+y) // octant 2
  drawpoint(xmin+r-x, ymax-r+y) // Octant 3
  drawpoint(xmax-r+x, ymin+r-y) // Octant 7
  drawpoint(xmin+r-x, ymin+r-y) // Octant 6
  drawpoint(xmax-r+y, ymax-r+x) // Octant 1
  drawpoint(xmin+r-y, ymax-r+x) // Octant 4
  drawpoint(xmax-r+y, ymin+r-x) // Octant 8
  drawpoint(xmin+r-y, ymin+r-x) // Octant 5

  UNLESS x=lastx DO
  { FOR fx = xmin+r-y+1 TO xmax-r+y-1 DO
    { drawpoint(fx, ymax-r+x)
      drawpoint(fx, ymin+r-x)
    }
    lastx := x
  }
  UNLESS y=lasty DO
  { FOR fx = xmin+r-x+1 TO xmax-r+x-1 DO
    { drawpoint(fx, ymax-r+y)
      drawpoint(fx, ymin+r-y)
    }
  }
}

currx, curry := x0, y0
}

AND drawcircle(x0, y0, radius) BE
{ // This is commonly called Bresenham's circle algorithm since it
  // is derived from Bresenham's line algorithm.
  LET f = 1 - radius
  LET ddf_x = 1
  LET ddf_y = -2 * radius
  LET x = 0
  LET y = radius
  drawpoint(x0, y0+radius)
  drawpoint(x0, y0-radius)
  drawpoint(x0+radius, y0)
  drawpoint(x0-radius, y0)

```

```

WHILE x<y DO
{ // ddf_x = 2*x + 1
  // ddf_y = -2 * y
  // f = x*x + y*y - radius*radius + 2*x - y + 1
  IF f>=0 DO
  { y := y-1
    ddf_y := ddf_y + 2
    f := f + ddf_y
  }
  x := x+1
  ddf_x := ddf_x + 2
  f := f + ddf_x
  drawpoint(x0+x, y0+y)
  drawpoint(x0-x, y0+y)
  drawpoint(x0+x, y0-y)
  drawpoint(x0-x, y0-y)
  drawpoint(x0+y, y0+x)
  drawpoint(x0-y, y0+x)
  drawpoint(x0+y, y0-x)
  drawpoint(x0-y, y0-x)
}
}

AND drawfillcircle1(x0, y0, radius) BE
{ IF y0<radius DO y0 := radius
  IF y0>=currysize-radius DO y0 := currysize-radius
  sys(Sys_sdl, sdl_drawfillcircle, currsurf, x0, currysize-y0, radius, colour)
}

AND drawfillcircle(x0, y0, radius) BE
{ // This is commonly called Bresenham's circle algorithm since it
  // is derived from Bresenham's line algorithm.
  LET f = 1 - radius
  LET ddf_x = 1
  LET ddf_y = -2 * radius
  LET x = 0
  LET y = radius
  LET lastx, lasty = 0, 0
  drawpoint(x0, y0+radius)
  drawpoint(x0, y0-radius)
  FOR x = x0-radius TO x0+radius DO drawpoint(x, y0)

  WHILE x<y DO
  { // ddf_x = 2*x + 1

```

```

// ddf_y = -2 * y
// f = x*x + y*y - radius*radius + 2*x - y + 1
IF f>=0 DO
{ y := y-1
  ddf_y := ddf_y + 2
  f := f + ddf_y
}
x := x+1
ddf_x := ddf_x + 2
f := f + ddf_x
drawpoint(x0+x, y0+y)
drawpoint(x0-x, y0+y)
drawpoint(x0+x, y0-y)
drawpoint(x0-x, y0-y)
drawpoint(x0+y, y0+x)
drawpoint(x0-y, y0+x)
drawpoint(x0+y, y0-x)
drawpoint(x0-y, y0-x)
UNLESS x=lastx DO
{ FOR fx = x0-y+1 TO x0+y-1 DO
  { drawpoint(fx, y0+x)
    drawpoint(fx, y0-x)
  }
  lastx := x
}
UNLESS y=lasty DO
{ FOR fx = x0-x+1 TO x0+x-1 DO
  { drawpoint(fx, y0+y)
    drawpoint(fx, y0-y)
  }
  lasty := y
}
}
}

AND getmousestate() = VALOF
{ writef("*ngetmousestate: not available*n")
  abort(999)
}

```

Appendix C

gl.h

This appendix give the source of the GL header file `cintcode/g/gl.h`. It is mainly here so I can proof read it on my iPad.

```
/*  
##### UNDER DEVELOPMENT #####
```

```
This is the header file for the BCPL graphics interface that should  
work with both OpenGL ES and the full version of OpenGL. The intention  
is for BCPL programs to work without change under either version of  
OpenGL.
```

```
This will be compiled with one of the following conditional  
compilation options set.
```

```
OpenGL      for the full OpenGL library used with SDL  
OpenGL ES   for OpenGL ES for the Raspberry Pi
```

```
Implemented by Martin Richards (c) Jan 2014
```

```
History:  
12/01/14  
Initial implementation
```

```
g_glbases is set in libhdr to be the first global used in the gl library  
It can be overridden by re-defining g_glbases after GETting libhdr.
```

```
A program wishing to use the SDL library should contain the following lines.
```

```
GET "libhdr"  
MANIFEST { g_glbases=nnn } // Only used if the default setting of 450 in  
// libhdr is not suitable.  
GET "gl.h"
```

```

GET "gl.b"                // Insert the library source code
.
GET "libhdr"
MANIFEST { g_glbases=nmn } // Only used if the default setting of 450 in
                           // libhdr is not suitable.

GET "gl.h"
Rest of the program
*/

GLOBAL {
// More functions will be included in due course
// All these functions capitalise the first letter of each
// word except the first, eg glMkScreen.
glInit: g_glbases

screen          // Handle to the screen surface
format          // Handle to the screen format, used by eg setcolour

screenxsize
screenysize

getevent        // sets event state
eventtype      // Event type set by getevent()
eventa1
eventa2
eventa3
eventa4
eventa5

glMkScreen      // (title, xsize, ysize)
glSetPerspective // (mat4, fov, aspect, n, f) -- Set the perspective matrix
glRadius2       // (x,y) Return sqrt(x**2+y**2) -- x, y and the result are floats
glRadius3       // (x,y,z) Return sqrt(x**2+y**2+z**2) -- x, y, z and the result are floats

loadmodel      // (filename, modelv) -- modelv = @VertexData

lex
ch
lineno
token
lexval

plotf          // (x, y, format, args...)
plotfstr       // Used by plotf
}

```

```

MANIFEST {
// ops used in calls of the form: sys(Sys_gl, op,...)
// These should work when using a properly configured BCPL Cintcode system
// running under Linux, Windows or or OSX provided the OpenGL libraries
// have been installed.
// All manifests start with a capital letter.

GL_Init=1           // initialise the GL library
GL_SetFltScale=2    // Specify the integer that represents floating 1.0
GL_Quit=3           // Shut down GL
GL_GetError=4       // str -- fill str with BCPL string for the latest GL error
GL_MkScreen=5       // width height
GL_SwapBuffers=6
GL_MkProg=7         // ()
GL_CompileVshader=8
GL_CompileFshader=9
GL_GetAttribLocation=10
GL_GetUniformLocation=11
GL_DeleteShader=12
GL_UseProgram=13
GL_LinkProgram=14
GL_Uniform1f=15
GL_Uniform2f=16
GL_Uniform3f=17
GL_Uniform4f=18
GL_LoadModel=19
GL_BindAttribLocation=20
GL_UniformMatrix4fv=21
GL_ClearColour=22
GL_ClearBuffer=23
GL_M4mulM4=24

GL_pollevent=25     // pointer to [type, args, ... ] to hold details of the next event
                    // return 0 if no events available

GL_Enable=26
GL_Disable=27
GL_DepthFunc=28
GL_VertexData=29
GL_DrawElements=30
GL_EnableVertexAttribArray=31
GL_DisableVertexAttribArray=32
GL_GenVertexBuffer=33
GL_GenIndexBuffer=34
GL_VertexAttribPointer=35

```

```

GL_M4mulV=36
GL_ScreenSize=37
GL_PrimitiveRestartIndex=38

sdle_active          = 1 // window gaining or losing focus
sdle_keydown         = 2 // => mod ch
sdle_keyup           = 3 // => mod ch
sdle_mousemotion     = 4 // => x y
sdle_mousebuttondown = 5 // => buttonbits
sdle_mousebuttonup   = 6 // => buttonbits
sdle_joyaxismotion   = 7
sdle_joyballmotion   = 8
sdle_joyhatmotion    = 9
sdle_joybuttondown   = 10
sdle_joybuttonup     = 11
sdle_quit            = 12
sdle_syswmevent      = 13
sdle_videoresize     = 14
sdle_userevent       = 15

sdle_arrowup         = 273
sdle_arrowdown       = 274
sdle_arrowright      = 275
sdle_arrowleft       = 276

// s_unset=0 // Used by loadmodel
// s_points
// s_lines
// s_linestrip
// s_lineloop
// s_triangles
// s_trianglestrip
// s_trianglefan

s_vs
s_v
s_is
s_ds
s_d
s_rgb
s_kd
s_num // Floating point value in lexval
s_eof

GL_DEPTH_TEST = 2929

```

```
GL_LESS      = 513  
}
```

Appendix D

gl.b

This appendix give the source of the GL BCPL library file `cintcode/g/gl.b`. It is mainly here so I can proof read it on my iPad.

```
/*  
##### UNDER DEVELOPMENT #####
```

```
This library provides some functions that interface with the OpenGL  
Graphics library that should work with both OpenGL ES using EGL and  
the full version of OpenGL using SDL. The intention is for BCPL  
programs to work without change under either version of OpenGL.
```

```
This will be compiled with one of the following conditional  
compilation options set.
```

```
OpenGL      for the full OpenGL library used with SDL  
OpenGLES    for OpenGL ES in the Raspberry Pi
```

```
Implemented by Martin Richards (c) Jan 2014
```

```
Most OpenGL functions are invoked using sys with calls of the form:
```

```
res := sys(Sys_gl, fno, a1, a2, a3, a4,...)
```

```
This is implemented by the function glfn defined  
in cintcode/sysc/glfn.c
```

```
Change history:
```

```
23/04/18
```

```
Changed load model to use the new .mdl format.
```

```
Extensively changed to use the FLT feature.
```

15/07/13

Started adding OpenGL functions.

26/08/12

Initial implementation.

This library provide the BCPL interface to the OpenGL features. Even if OpenGL is called from EGL and not SDL, the SDL features will be available providing access to keyboard, mouse and joy stick events, and possibly sound features. Most OpenGL library functions are invoked using call such as `sys(Sys_gl, GL_CompileVshader, prog, cstr)` where the extra arguments are 32-bit values some of which are floating point numbers. This interface is implemented by the C function `glfn` defined in `cintsys/stsc/glfn.c`. Other useful functions are defined in this file.

This library should be included as a separate section for programs that need it. Such programs typically have the following structure.

Note that most OpenGL functions are called via the `sys` function as in: `sys(Sys_gl, GL_BindAttribLocation, prog, loc, name)`. The extra arguments are all 32-bit values some of which may be floating point. The code in `sysc/glfn.c` converts them where necessary to the types required by OpenGL.

```

GET "libhdr"
MANIFEST { g_glbases=nnn } // Only used if the default setting of 450 in
                          // libhdr is not suitable.

GET "gl.h"
GET "gl.b"                // Insert the library source code
.
GET "libhdr"
MANIFEST { g_glbases=nnn } // Only used if the default setting of 450 in
                          // libhdr is not suitable.

GET "gl.h"
Rest of the program

*/

LET glInit() = VALOF
{ LET mes = VEC 256/bytesperword
  mes%0 := 0

  UNLESS sys(Sys_gl, GL_Init) DO
  { //sys(Sys_gl, GL_getError, mes)

```

```

    sawritef("nglInit unable to initialise OpenGL: %s*n", mes)
    RESULTIS FALSE
}

RESULTIS TRUE // Successful return
}

AND glMkScreen(title, xsize, ysize) = VALOF
{ // Create an OpenGL window with given title and size
  LET mes = VEC 256/bytesperword
  mes%0 := 0

  //writef("glMkScreen: Creating an OpenGL window*n")

  screenxsize, screenysize := xsize, ysize

  //writef("MkScreen: calling sys(Sys_gl, GL_MkScreen, %s, %n %n)*n",
  //      title, xsize, ysize)

  screenxsize := sys(Sys_gl, GL_MkScreen, title, xsize, ysize)
  screenysize := result2

  writef("GL_MkScreen: returned screen size %n x %n*n",
        screenxsize, screenysize)

  UNLESS screenxsize>0 DO
  { //sys(Sys_gl, GL_GetError, mes)
    writef("Unable to create an OpenGL screen: *n", mes)
    RESULTIS 0
  }

  result2 := screenysize
  RESULTIS screenxsize
}

AND glSetPerspective(mat4, FLT aspect, FLT fov, FLT n, FLT f) BE
{ // The field of view is given as a field of view at unit distance
  // ie field of view is 45 degrees if fov=2.0
  // aspect = width/height of screen in pixels
  LET FLT fv = 2.0 / fov

  setvec(mat4, 16, fv, 0.0,          0.0, 0.0, // Column 1
          0.0, fv,                0.0, 0.0, // Column 2
          0.0, 0.0, (f+n)/(n-f), -1.0, // Column 3
          0.0, 0.0, (2*f*n)/(n-f), 0.0) // Column 4

```

```
}

```

```
AND glRadius2(FLT x, FLT y) = VALOF
{ LET FLT a = x*x + y*y
  RESULTIS sys(Sys_flt, fl_sqrt, a)
}
```

```
AND glRadius3(FLT x, FLT y, FLT z) = VALOF
{ LET FLT a = x*x + y*y + z*z
  RESULTIS sys(Sys_flt, fl_sqrt, a)
}
```

```
AND tok2str(tok) = VALOF SWITCHON tok INTO
{ DEFAULT:      RESULTIS "?"
  CASE s_vs:    RESULTIS "vs"
  CASE s_v:     RESULTIS "v"
  CASE s_is:    RESULTIS "is"
  CASE s_ds:    RESULTIS "ds"
  CASE s_d:     RESULTIS "d"
  CASE s_rgb:   RESULTIS "rgb"
  CASE s_kd:    RESULTIS "kd"
  CASE s_num:   RESULTIS "num"
  CASE s_eof:   RESULTIS "eof"
}
```

```
AND getevent() = VALOF
{ //writef("gl: Calling sys(Sys_sdl, GL_pollevent...)*n")
  RESULTIS sys(Sys_gl, GL_pollevent, @eventtype)
}
```

```
AND error(mes, a, b, c) BE
{ // For error found by loadmodel.
  writef("ERROR nearline %n: ", lineno)
  writef(mes, a, b, c)
  newline()
}
```

```
AND rdnum() = VALOF
{ LET res = lexval
  UNLESS token=s_num DO error("Number expected")
  lex()
  RESULTIS res
}
```

```
AND loadmodel(filename, modelv) = VALOF
```

```

{ // This function reads a .mdl file specifying the vertices and
  // indices of a model. It returns TRUE if successful.

  // Syntax

  // vs n          the size of the vertex data vector
  // is n          set the size of the index vector
  // rgb r b g     set the current colour
  // kd k d       set the k and d values
  // v x y z       set a vertex using current colour and kd values
  // n            set another index vector element
  // ds n         set the size of the display items vector and read them
  // d mode size offset  set a display item
  //                where mode   is 1  points
  //                2  separate lines
  //                3  line strip
  //                4  line loop
  //                5  triangles
  //                6  triangle strip
  //                7  triangle fan
  //                size   is the number of index value belonging
  //                to this display item.
  //                and   offset is a subscript of the index vector
  // z            end of file

  // loadmodel updates

  // modelv!0 to point to the vertex data.
  // modelv!1 the number of values in the vertex data.
  // modelv!2 to point to the index vector of 16-bit values.
  // modelv!3 the number of 16-bit values in the index vector.
  // modelv!4 to point to the display items vector.
  // modelv!5 the number of words in the display items vector.

  LET res = TRUE
  LET stdin = input()
  LET instream = findinput(filename)

  // Once an item type has been chosen its values are given as a sequence
  // of vertices, until another item type is given. If the previous item type
  // was greater than zero, its length is filled in.

  LET curr_r, curr_g, curr_b = 0.0, 0.0, 0.0
  LET curr_k, curr_d = 0.0, 0.0

```

```

// Declare self expanding vectors for the
LET vvec, vvecupb = 0, 0 // vertices, each vertex is [x,y,z, r,g,b, k,d]
LET ivec, ivecupb = 0, 0 // index vector
LET dvec, dvecupb = 0, 0 // display items, each item is [mode, i, size]
LET vpos = 0 // current position in the Vertex vector.
LET ipos = 0 // current position in the Index vector.
LET dpos = 0 // current position in the Display items vector.

lineno := 1 // The first line has lineno=1

UNLESS instream DO
{ error("Trouble with file %s", filename)
  RESULTIS FALSE
}

selectinput(instream)

ch := rdch()

nxt:
//sawwritef("loadmodel: about to call lex()*n"); checkpos(ch)
lex()

UNTIL token=s_eof SWITCHON token INTO
{ DEFAULT: writef("line %n: Bad model file*n", lineno)
  res := FALSE
  GOTO ret

CASE s_vs: // Set vvecupb and allocate space
  lex()
  vvecupb := FIX rdnum()
//writef("lineno=%i3 token=%s lexval=%13.3f*n", lineno, tok2str(token), lexval)
writef("vs: vvecupb=%n*n", vvecupb)
//abort(1000)
  vvec := getvec(vvecupb)
  UNLESS vvec DO
  { writef("Unable to allocate vvec with upb=%n*n", vvecupb)
    RESULTIS FALSE
  }
  LOOP

CASE s_v: // A vertex
{ LET val = ?
  IF vvec=0 DO
  { writef("Vertex given before the vector is allocated*n")

```

```

        abort(999)
    }
    IF vpos+8>=vvecupb DO
    { writef("Too many dvec items  vpos=%n vvecupb=%n*n", vpos, vvecupb)
      abort(999)
    }
    lex()
    val := rdnum()
    vpos := push32(vvec, vpos, vvecupb, val)    // x
    val := rdnum()
    vpos := push32(vvec, vpos, vvecupb, val)    // y
    val := rdnum()
    vpos := push32(vvec, vpos, vvecupb, val)    // z

    vpos := push32(vvec, vpos, vvecupb, curr_r) // curr_r
    vpos := push32(vvec, vpos, vvecupb, curr_g) // curr_g
    vpos := push32(vvec, vpos, vvecupb, curr_b) // curr_b

    vpos := push32(vvec, vpos, vvecupb, curr_k) // curr_k
    vpos := push32(vvec, vpos, vvecupb, curr_d) // curr_d
//writef("v:")
//FOR i = -8 TO -1 DO writef(" %10.3f", vvec!(i+vpos))
//newline()
//abort(1000)
    LOOP
}

CASE s_is:          // Set ivec upb and allocate space
    lex()
    ivecupb := FIX rdnum()
//writef("i: ivecupb=%n*n", ivecupb)
    ivec := getvec(ivecupb/2)
    UNLESS ivec DO
    { writef("Unable to allocate ivec with upb=%n*n", ivecupb)
      RESULTIS FALSE
    }
//abort(1000)
    LOOP

CASE s_ds:          // Set dvec size and allocate its vector
    lex()
    dvecupb := FIX rdnum()
//writef("d: dvecupb=%n*n", dvecupb)
    dvec := getvec(dvecupb)
    UNLESS dvec DO

```

```

    { writef("Unable to allocate dvec with upb=%n*n", dvecupb)
      RESULTIS FALSE
    }
    FOR i = 0 TO dvecupb DO dvec!i := 0 // Clear the dvec vector
//abort(1000)
    LOOP

CASE s_d:          // Set a display vector item
  UNLESS dvec DO
    { writef("Display item given before the vector is allocated*n")
      abort(999)
    }
    IF dpos+3 > dvecupb DO
    { error("Too many dvec items, dpos=%n dvecupb=%n*n", dpos, dvecupb)
      abort(999)
    }
    lex()
    dvec!dpos := FIX rdnum()          // mode
    dpos := dpos+1
    dvec!dpos := FIX rdnum()          // n
    dpos := dpos+1
    dvec!dpos := FIX rdnum()          // offset
    dpos := dpos+1
    LOOP

CASE s_rgb:        // Set the current colour
  lex()
  curr_r := rdnum()
  curr_g := rdnum()
  curr_b := rdnum()
//writef("rgb: %8.3f %8.3f %8.3f*n", curr_r, curr_g, curr_b)
//abort(1000)
  LOOP

CASE s_kd:         // Set the current kd values
  lex()
  curr_k := rdnum()
  curr_d := rdnum()
//writef("kd: %8.3f %8.3f*n", curr_k, curr_d)
//abort(1000)
  LOOP

CASE s_num:        // An index vector value
  { LET val = 0
    UNLESS ivec DO

```



```

    { writef("Index value given before the index vector is allocate*n")
      abort(999)
    }
    IF ipos>ivecupb DO
    { writef("Too many index values, ipos=%n ivecubp=%n*n", ipos, ivecubp)
      abort(999)
    }
    val := FIX rdnum()
    ipos := push16(ivec, ipos, ivecubp, val)
    LOOP
  }

CASE s_eof:
  //writef("eof*n")
  token := s_eof
ENDCASE
}

UNLESS vvec & ivec & dvec DO
{ error("One or more of vvec, ivec or dvec is missing")
  res := FALSE
  GOTO ret
}

modelv!0, modelv!1 := vvec, vvecubp
modelv!2, modelv!3 := ivec, ivecubp
modelv!4, modelv!5 := dvec, dvecubp

ret:
  IF instream DO endstream(instream)
  selectinput(stdin)
  //writef("Returning from loadmodel*n")
  RESULTIS res
}

AND checkfor(tok, mess) BE
{ UNLESS token=tok DO
  { writef("ERROR: %s token=%s tok=%s", mess, tok2str(token), tok2str(tok))
  }
  lex()
}

AND lex() BE
{ SWITCHON ch INTO
  { DEFAULT:

```

```

    error("line %n: Bad character '%c' in model file", lineno, ch)
    ch := rdch()
    LOOP

CASE 'z':           // A debugging aid
CASE endstreamch:
    token := s_eof   // marks the end of file.
    RETURN

CASE '/': // Skip over comments
    UNTIL ch='*' | ch=endstreamch DO ch := rdch()
    LOOP

CASE '*n':
    lineno := lineno+1

CASE '*s':
    ch := rdch()
    LOOP

CASE 'v':
    token := s_v     // A vertex
    ch := rdch()
    IF ch='s' DO     // Upb of vvec
    { token := s_vs
      ch := rdch()
    }
    RETURN

CASE 'i':           // Size of index vector.
    ch := rdch()
    UNLESS ch='s' DO error("Bad 'is' statement")
    token := s_is
    ch := rdch()
    RETURN

CASE 'd':
    token := s_d     // A diplay item
    ch := rdch()
    IF ch='s' DO
    { token := s_ds   // Number of the display items
      ch := rdch()
    }
    RETURN

```

```

CASE 'r':
  ch := rdch()
  IF ch='g' DO
  { ch := rdch()
    IF ch='b' DO
    { token := s_rgb // rgb
      ch := rdch()
      RETURN
    }
  }
  error("Bad 'rgb' token")
LOOP

CASE 'k':
  ch := rdch()
  IF ch='d' DO
  { token := s_kd // kd
    ch := rdch()
    RETURN
  }
  writef("Bad 'kd' token")
LOOP

CASE '-': CASE '+':
CASE '0': CASE '1': CASE '2': CASE '3': CASE '4':
CASE '5': CASE '6': CASE '7': CASE '8': CASE '9':
  unrdch()

  lexval := readflt()
  IF result2 DO
  { error("Bad floating point number")
    abort(999)
  }
  // Re-read the terminating character
  ch := rdch()
  token := s_num
  RETURN
}
} REPEAT

AND push32(v, i, upb, val) = VALOF
{ IF i > upb DO
  { error("Unable to push a 32-bit value, upb=%n", upb)
    RESULTIS i+1
  }
}

```

```

    v!i := val
    RESULTIS i+1
}

AND push16(v, i, upb, val) = VALOF
{ IF i > upb DO
  { error("Unable to push a 16-bit value, upb=%n", upb)
    RESULTIS i+1
  }
  put16(v, i, val)
  RESULTIS i+1
}

AND get16(v, i) = VALOF
{ LET w = 0
  LET p = 2*i
  LET a, b = v%p, v%(p+1)
  (@w)%0 := 1
  TEST (w & 1) = 0
  THEN RESULTIS (a<<8) + b // Big ender m/c
  ELSE RESULTIS (b<<8) + a // Little ender m/c
}

AND put16(v, i, val) BE
{ LET w = 0
  LET p = 2*i
  LET a, b = val&255, (val>>8) & 255
  (@w)%0 := 1
  TEST (w & 1) = 0
  THEN v%p, v%(p+1) := b, a // Big ender m/c
  ELSE v%p, v%(p+1) := a, b // Little ender m/c
}

/*
// The following functions will be available when I discover
// how to implement drawpoint under OpenGL.

AND drawch(ch) BE TEST ch='*n'
THEN { currx, curry := 10, curry-14
  }
ELSE { FOR line = 0 TO 11 DO
  write_ch_slice(currx, curry+11-line, ch, line)
  currx := currx+9
  }
}

```

```

AND write_ch_slice(x, y, ch, line) BE
{ // Writes the horizontal slice of the given character.
  // Character are 8x12
  LET cx, cy = currx, curry
  LET i = (ch&#x7F) - '*s'
  // 3*i = subscript of the character in the following table.
  LET charbase = TABLE // Still under development !!!
    #X00000000, #X00000000, #X00000000, // space
    #X18181818, #X18180018, #X18000000, // !
    #X66666600, #X00000000, #X00000000, // "
    #X6666FFFF, #X66FFFF66, #X66000000, // #
    #X7EFFF8FE, #X7F1B1BFF, #X7E000000, // $
    #X06666C0C, #X18303666, #X60000000, // %
    #X3078C8C8, #X7276DCCC, #X76000000, // &
    #X18181800, #X00000000, #X00000000, // '
    #X18306060, #X60606030, #X18000000, // (
    #X180C0606, #X0606060C, #X18000000, // )
    #X00009254, #X38FE3854, #X92000000, // *
    #X00000018, #X187E7E18, #X18000000, // +
    #X00000000, #X00001818, #X08100000, // ,
    #X00000000, #X007E7E00, #X00000000, // -
    #X00000000, #X00000018, #X18000000, // .
    #X06060C0C, #X18183030, #X60600000, // /
    #X386CC6C6, #XC6C6C66C, #X38000000, // 0
    #X18387818, #X18181818, #X18000000, // 1
    #X3C7E6206, #X0C18307E, #X7E000000, // 2
    #X3C6E4606, #X1C06466E, #X3C000000, // 3
    #X1C3C3C6C, #XCFFFF0C, #X0C000000, // 4
    #X7E7E6060, #X7C0E466E, #X3C000000, // 5
    #X3C7E6060, #X7C66667E, #X3C000000, // 6
    #X7E7E0606, #X0C183060, #X40000000, // 7
    #X3C666666, #X3C666666, #X3C000000, // 8
    #X3C666666, #X3E060666, #X3C000000, // 9
    #X00001818, #X00001818, #X00000000, // :
    #X00001818, #X00001818, #X08100000, // ;
    #X00060C18, #X30603018, #X0C060000, // <
    #X00000000, #X7C007C00, #X00000000, // =
    #X00603018, #X0C060C18, #X30600000, // >
    #X3C7E0606, #X0C181800, #X18180000, // ?
    #X7E819DA5, #XA5A59F80, #X7F000000, // @
    #X3C7EC3C3, #XFFFFC3C3, #XC300000, // A
    #XFEFFC3FE, #XFEC3C3FF, #XFE000000, // B
    #X3E7FC3C0, #XC0C0C37F, #X3E000000, // C
    #XFCFEC3C3, #XC3C3C3FE, #XFC000000, // D
    #XFFFFC0FC, #XFCC0C0FF, #XFF000000, // E

```

```

#FFFFFF0FC, #XFCC0C0C0, #XC0000000, // F
#X3E7FE1C0, #XCFCFE3FF, #X7E000000, // G
#XC3C3C3FF, #XFFC3C3C3, #XC3000000, // H
#X18181818, #X18181818, #X18000000, // I
#X7F7F0C0C, #X0C0CCFC, #X78000000, // J
#XC2C6CCD8, #XF0F8CCC6, #XC2000000, // K
#XC0C0C0C0, #XC0C0C0FE, #XFE000000, // L
#X81C3E7FF, #XDBC3C3C3, #XC3000000, // M
#X83C3E3F3, #XDBCFC7C3, #XC1000000, // N
#X7E7FC3C3, #XC3C3C3FF, #X7E000000, // O
#XFE7FC3C3, #XFFFECC0C0, #XC0000000, // P
#X7E7FC3C3, #XDBCFC7FE, #X7D000000, // Q
#XFE7FC3C3, #XFFFECCC6, #XC3000000, // R
#X7EC3C0C0, #X7E0303C3, #X7E000000, // S
#XFFFF1818, #X18181818, #X18000000, // T
#XC3C3C3C3, #XC3C3C37E, #X3C000000, // U
#X81C3C366, #X663C3C18, #X18000000, // V
#XC3C3C3C3, #XDBFFE7C3, #X81000000, // W
#XC3C3663C, #X183C66C3, #XC3000000, // X
#XC3C36666, #X3C3C1818, #X18000000, // Y
#XFFFF060C, #X183060FF, #XFF000000, // Z
#X78786060, #X60606060, #X78780000, // [
#X60603030, #X18180C0C, #X06060000, // \
#X1E1E0606, #X06060606, #X1E1E0000, // ]
#X10284400, #X00000000, #X00000000, // ^
#X00000000, #X00000000, #X00FFFF00, // _
#X30180C00, #X00000000, #X00000000, // `
#X00007AFE, #XC6C6C6FE, #X7B000000, // a
#XC0C0DCFE, #XC6C6C6FE, #XDC000000, // b
#X00007CFE, #XC6C0C6FE, #X7C000000, // c
#X060676FE, #XC6C6C6FE, #X76000000, // d
#X00007CFE, #XC6FCC0FE, #X7C000000, // e
#X000078FC, #XC0F0F0C0, #XC0000000, // f
#X000076FE, #XC6C6C6FE, #X7606FE7C, // g
#XC0C0DCFE, #XC6C6C6C6, #XC6000000, // h
#X18180018, #X18181818, #X18000000, // i
#XC0C000C, #XC0C0C07C, #X38000000, // j
#X00C0C6CC, #XD8F0F8CC, #XC6000000, // k
#X00606060, #X6060607C, #X38000000, // l
#X00006CFE, #XD6D6D6D6, #XD6000000, // m
#X0000DCFE, #XC6C6C6C6, #XC6000000, // n
#X00007CFE, #XC6C6C6FE, #X7C000000, // o
#X00007CFE, #XC6FEFCC0, #XC0000000, // p
#X00007CFE, #XC6FE7E06, #X06000000, // q
#X0000DCFE, #XC6C0C0C0, #XC0000000, // r

```

```

#X00007CFE, #XC07C06FE, #X7C000000, // s
#X0060F8F8, #X6060607C, #X38000000, // t
#X0000C6C6, #XC6C6C6FE, #X7C000000, // u
#X0000C6C6, #X6C6C6C38, #X10000000, // v
#X0000D6D6, #XD6D6D6FE, #X6C000000, // w
#X0000C6C6, #X6C386CC6, #XC6000000, // x
#X0000C6C6, #XC6C6C67E, #X7606FE7C, // y
#X00007EFE, #X0C3860FE, #XFC000000, // z
#X0C181808, #X18301808, #X18180C00, // {
#X18181818, #X18181818, #X18181800, // |
#X30181810, #X180C1810, #X18183000, // }
#X00000070, #XD1998B0E, #X00000000, // ~
#XAA55AA55, #XAA55AA55, #XAA55AA55 // rubout

IF i>=0 DO charbase := charbase + 3*i

// charbase points to the three words giving the
// pixels of the character.
{ LET col = colour
  LET w = VALOF SWITCHON line INTO
  { CASE 0: RESULTIS charbase!0>>24
    CASE 1: RESULTIS charbase!0>>16
    CASE 2: RESULTIS charbase!0>> 8
    CASE 3: RESULTIS charbase!0
    CASE 4: RESULTIS charbase!1>>24
    CASE 5: RESULTIS charbase!1>>16
    CASE 6: RESULTIS charbase!1>> 8
    CASE 7: RESULTIS charbase!1
    CASE 8: RESULTIS charbase!2>>24
    CASE 9: RESULTIS charbase!2>>16
    CASE 10: RESULTIS charbase!2>> 8
    CASE 11: RESULTIS charbase!2
  }
}

IF ((w >> 7) & 1) = 1 DO drawpoint(x, y)
IF ((w >> 6) & 1) = 1 DO drawpoint(x+1, y)
IF ((w >> 5) & 1) = 1 DO drawpoint(x+2, y)
IF ((w >> 4) & 1) = 1 DO drawpoint(x+3, y)
IF ((w >> 3) & 1) = 1 DO drawpoint(x+4, y)
IF ((w >> 2) & 1) = 1 DO drawpoint(x+5, y)
IF ((w >> 1) & 1) = 1 DO drawpoint(x+6, y)
IF (w & 1) = 1 DO drawpoint(x+7, y)

//writef("writeslice: ch=%c line=%i2 w=%b8 bits=%x8 %x8 %x8*n",
//      ch, line, w, charbase!0, charbase!1, charbase!2)

```

```
    }

    currx, curry := cx, cy
}

AND drawstring(x, y, s) BE
{ moveto(x, y)
  FOR i = 1 TO s%0 DO drawch(s%i)
}

AND plotf(x, y, form, a, b, c, d, e, f, g, h) BE
{ LET oldwrch = wrch
  LET s = VEC 256/bytesperword
  plotfstr := s
  plotfstr%0 := 0
  wrch := plotwrch
  writef(form, a, b, c, d, e, f, g, h)
  wrch := oldwrch
  drawstring(x, y, plotfstr)
}

AND plotwrch(ch) BE
{ LET strlen = plotfstr%0 + 1
  plotfstr%strlen := ch
  plotfstr%0 := strlen
}
*/
```

Appendix E

gl.b

This appendix give the source of the GL BCPL library file `cintcode/g/gl.b`. It is mainly here so I can proof read it on my iPad.

```
/*
```

```
This contains the implemetation of the sys(Sys_gl, fno, ...) facility.
```

```
##### Still under development #####
```

```
Implemented by Martin Richards (c) Mar 2015
```

```
This file is planned to provide and interface to either OpenGL using SDL or OpenGL ES using EGL (typically for the Raspberry Pi). To hide the differences between these two versions of OpenGL, BCPL programs should use the g/gl.b library with the g/gl.h header file.
```

```
SDLavail is defined only if GL is called from SDL
```

```
GLavail is defined if OpenGL or OpenGL ES libraries are available.
```

```
EGLavail is defined if GL is called from EGL
```

```
GLUTAvail is defined if the GLUT library is available
```

```
Note that RaspiGL uses EGL to call GL but also uses some features provided by the SDL libraries. SDLavail and EGLavail will never both be defined.
```

```
Whichever version of OpenGL is used the BCPL interface using
```

```
res := sys(Sys_gl, fno, a1, a2, a3, a4,...)
```

```
has the same effect.
```

```
Note that this calls glfn(args, g, w)
```

```
where args[0] = fno, args[1]=a1,... etc
```

```
and g points to the base of the global vector,
```

and w points to the base of the Cintcode memory.

fno=0 Test that a version of OpenGL is available
res is TRUE if it is.

fno=1 ...

Possible value for fno have the following manifest constants.

```

GL_Init           // initialise SDL with everything
GL_SetFltScale   // Specify the integer that represents floating 1.0
GL_Quit          // Shut down SDL
GL_GetError      // str -- fill str with BCPL string for the latest GL error
GL_MkScreen      // width height
GL_SwapBuffers
GL_MkProg
GL_CompileVshader
GL_CompileFshader
GL_GetAttribLocation
GL_GetUniformLocation
GL_DeleteShader
GL_UseProgram
GL_LinkProgram
GL_Uniform1f
GL_Uniform2f
GL_Uniform3f
GL_Uniform4f
GL_LoadModel
GL_BindAttribLocation
GL_UniformMatrix4fv
GL_ClearColour
GL_ClearBuffer
GL_M4mulM4

GL_pollevent     // pointer to [type, args, ... ] to hold details of the next event
                 // return 0 if no events available

GL_Enable
GL_Disable
GL_DepthFunc
GL_VertexData
GL_DrawTriangles
GL_EnableVertexAttribArray
GL_DisableVertexAttribArray
GL_GenVertexBuffer
GL_GenIndexBuffer

```

```

GL_VertexAttribPointer
GL_M4mulV

*/

#include "cintsys.h"

// Conversion between BCPL and C strings
extern char *b2c_str(BCPLWORD bstr, char *cstr);
extern BCPLWORD c2b_str(const char *cstr, BCPLWORD bstr);

#include <stdio.h>
#include <stdlib.h>

#ifdef forRaspiGL
#define GLavail
#define EGLavail
#endif

#ifndef GLavail
BCPLWORD glfn(BCPLWORD *args, BCPLWORD *g, BCPLWORD *W) {
    //printf("glfn: GLavail was not defined\n");
    return 0;    // GL is not available
}
#endif

#ifdef GLavail

// If SDLavail include the SDL headers since GL is being called from SDL
// and EGL is not present.
#ifdef SDLavail
#ifdef forWIN32
#include <SDL.h>
#else
#include <SDL/SDL.h>
#endif
#endif

// RaspiGL uses EGL to call GL but also uses some SDL features.
#ifdef forRaspiGL

#include <assert.h>

#include "bcm_host.h"
#include "GLES2/g12.h"

```

```
#include "EGL/egl.h"
#include "EGL/eglext.h"
// If RaspiGL we use SDL to access keyboard, Mouse and Joystick events
// so include the SDL headers
#include <SDL.h>
#endif

#ifdef forRaspiGL
#include <GL/gl.h>
//#include <GL/glu.h>
//#include <GL/glut.h>
#include <EGL/egl.h>
#endif

#ifdef GLavail
// These must agree with the declarations in g/gl.h
#define gl_Init 1
#define gl_SetFltScale 2
#define gl_Quit 3
#define gl_GetError 4
#define gl_MkScreen 5
#define gl_SwapBuffers 6
#define gl_MkProg 7
#define gl_CompileVshader 8
#define gl_CompileFshader 9
#define gl_GetAttribLocation 10
#define gl_GetUniformLocation 11
#define gl_DeleteShader 12
#define gl_UseProgram 13
#define gl_LinkProgram 14
#define gl_Uniform1f 15
#define gl_Uniform2f 16
#define gl_Uniform3f 17
#define gl_Uniform4f 18
#define gl_BindAttribLocation 20
#define gl_UniformMatrix4fv 21
#define gl_ClearColour 22
#define gl_ClearBuffer 23
#define gl_M4mulM4 24
#define gl_pollevent 25
#define gl_Enable 26
#define gl_Disable 27
#define gl_DepthFunc 28
#define gl_VertexData 29
```

```
#define gl_DrawElements          30
#define gl_EnableVertexAttribArray 31
#define gl_DisableVertexAttribArray 32
#define gl_GenVertexBuffer      33
#define gl_GenIndexBuffer       34
#define gl_VertexAttribPointer  35
#define gl_M4mulV                36
#define gl_ScreenSize           37
#define gl_PrimitiveRestartIndex 38

// Joystick functions -- implemented using SDL
#define gl_numjoysticks         41
#define gl_joystickopen        42
#define gl_joystickclose       43
#define gl_joystickname        44
#define gl_joysticknumaxes     45
#define gl_joysticknumbuttons  46
#define gl_joysticknumballs    47
#define gl_joysticknumhats     48

#define gl_joystickeventstate  49

#define gl_joystickgetbutton    55
#define gl_joystickgetaxis     56
#define gl_joystickgetball     57
#define gl_joystickgethat      58

#endif

#ifdef EGLavail
typedef struct
{
    uint32_t screen_width;
    uint32_t screen_height;
// OpenGL|ES objects
    EGLDisplay display;
    EGLSurface surface;
    EGLContext context;

    GLuint verbose;
    GLuint vshader;
    GLuint fshader;
    GLuint mshader;

```

```

    GLuint program;
    GLuint program2;
    GLuint tex_fb;
    GLuint tex;
    GLuint buf;
// julia attribs
    GLuint unif_color, attr_vertex, unif_scale, unif_offset, unif_tex, unif_centre;
// mandelbrot attribs
    GLuint attr_vertex2, unif_scale2, unif_offset2, unif_centre2;
} CUBE_STATE_T;

static CUBE_STATE_T _state, *state=&_state;

#define check() assert(glGetError() == 0)

#endif

typedef union fn {
    BCPLWORD i;
    GLfloat f;
} FN;

#ifdef SDLavail
const SDL_VideoInfo* info = NULL;
int width = 700;
int height = 200;
int bpp = 0;
int flags=0; // Flag to pass to SDL_SetVideoMode
#endif

GLuint glProgram;

BCPLWORD decodeevent1(SDL_Event*e, BCPLWORD *ptr) {
    if(e) {
        ptr[0] = (BCPLWORD)(e->type);
        switch (e->type) {
            default:
                printf("glfn: Unknown event type %d\n", e->type);
                return -1;

            case SDL_ACTIVEEVENT: // 1
                ptr[1] = (BCPLWORD)(e->active).gain; // 0 if loss, 1 if gain
                ptr[2] = (BCPLWORD)(e->active).state; // 0=mouse focus, 1=keyboard focus,
                // 2=minimised
        }
    }
}

```

```

    return -1;

case SDL_KEYDOWN:          // 2
case SDL_KEYUP:           // 3
    //printf("getevent: KEYDOWN or UP\n");
    { SDL_ksym *ks = &(e->key).ksym;
      BCPLWORD sym = ks->sym;
      BCPLWORD mod = ks->mod;
      BCPLWORD ch = (BCPLWORD)(ks->unicode);
      if(ch==0) ch = sym;
      ptr[1] = mod;
      ptr[2] = ch;
      return -1;
    }

case SDL_MOUSEMOTION:     // 4
    ptr[1] = (BCPLWORD)(e->motion).state;
    ptr[2] = (BCPLWORD)(e->motion).x;
    ptr[3] = (BCPLWORD)(e->motion).y;
    //printf("getevent: MOUSEMOTION %4d %4d %4d\n", ptr[1], ptr[2], ptr[3]);
    return -1;

case SDL_MOUSEBUTTONDOWN: // 5
case SDL_MOUSEBUTTONUP:   // 6
    ptr[1] = (BCPLWORD)(e->button).state;
    ptr[2] = (BCPLWORD)(e->button).x;
    ptr[3] = (BCPLWORD)(e->button).y;
    //printf("getevent: MOUSEBUTTONDOWN/UP %4d %4d %4d\n", ptr[1], ptr[2], ptr[3]);
    return -1;

case SDL_JOYAXISMOTION:   // 7
    ptr[1] = (BCPLWORD)(e->jaxis).which; // Which joystick
    ptr[2] = (BCPLWORD)(e->jaxis).axis;  // Which axis
                                         // 0 = aileron
                                         // 1 = elevator
                                         // 2 = throttle
    ptr[3] = (BCPLWORD)(e->jaxis).value; // What value -32768 to + 32767
    return -1;

case SDL_JOYBALLMOTION:   // 8
    ptr[1] = (BCPLWORD)(e->jball).which; // Which joystick
    ptr[2] = (BCPLWORD)(e->jball).ball;  // Which ball
    ptr[3] = (BCPLWORD)(e->jball).xrel;  // X relative motion
    ptr[4] = (BCPLWORD)(e->jball).yrel;  // Y relative motion
    return -1;

```

```

case SDL_JOYHATMOTION:    // 9
    ptr[1] = (BCPLWORD)(e->jhat).which; // Which joystick
    ptr[2] = (BCPLWORD)(e->jhat).hat;   // Which hat
    ptr[3] = (BCPLWORD)(e->jhat).value; // Hat position
    return -1;

case SDL_JOYBUTTONDOWN:  // 10
case SDL_JOYBUTTONUP:    // 11
    ptr[1] = (BCPLWORD)(e->jbutton).which; // Which joystick
    ptr[2] = (BCPLWORD)(e->jbutton).button; // Which button
    ptr[3] = (BCPLWORD)(e->jbutton).state; // What state
    return -1;

case SDL_QUIT:           // 12
    return -1;

case SDL_SYSWMEVENT:     // 13
    return -1;

case SDL_VIDEORESIZE:    // 16
    ptr[1] = (BCPLWORD)(e->resize).w; // New window width
    ptr[2] = (BCPLWORD)(e->resize).h; // New window height
    //printf("VIDEORESIZE=%d\n", SDL_VIDEORESIZE);
    return -1;

case SDL_VIDEOEXPOSE:    // 17
    // Screen needs to be redrawn
    //printf("VIDEOEXPOSE=%d\n", SDL_VIDEOEXPOSE);
    return -1;

case SDL_USEREVENT:      // 24
    return -1;
}
}
*ptr = 0;
return 0;
}
#endif GLavail

BCPLWORD glfn(BCPLWORD *a, BCPLWORD *g, BCPLWORD *W) {
    char tmpstr[256];
    //int argc = 0;

    //printf("glfn: GLavail was defined\n");

```



```

//printf("glfn: fno=%d a1=%d a2=%d a3=%d a4=%d\n",
//      a[0], a[1], a[2], a[3], a[4]);

switch(a[0]) {
default:
    printf("glfn: Unknown op: fno=%d a1=%d a2=%d a3=%d a4=%d\n",
          a[0], a[1], a[2], a[3], a[4]);
    return 0;

case gl_Init:
    #ifdef SDLavail
    printf("SDLavail is set\n");
    #endif
    #ifdef EGLavail
    printf("EGLLavail is set\n");
    #endif
    #ifdef GLavail
    printf("GLavail is set\n");
    #endif

#ifdef forRaspiGL
    { //gl_init
    int32_t success = 0;
    EGLBoolean result;
    EGLint num_config;

    static EGL_DISPMANX_WINDOW_T nativewindow;

    DISPMANX_ELEMENT_HANDLE_T dispman_element;
    DISPMANX_DISPLAY_HANDLE_T dispman_display;
    DISPMANX_UPDATE_HANDLE_T dispman_update;
    VC_RECT_T dst_rect;
    VC_RECT_T src_rect;

    static const EGLint attribute_list[] =
    {
        EGL_RED_SIZE, 8,
        EGL_GREEN_SIZE, 8,
        EGL_BLUE_SIZE, 8,
        EGL_ALPHA_SIZE, 8,
        EGL_SURFACE_TYPE, EGL_WINDOW_BIT,
        EGL_DEPTH_SIZE, 16,
        EGL_NONE
    };
};

```

```

static const EGLint context_attributes[] =
{
    EGL_CONTEXT_CLIENT_VERSION, 2,
    EGL_NONE
};

EGLConfig config;

// RaspiGL uses some SDL features so initialise SDL
//printf("Calling SDL_Init\n");

{ BCPLWORD res = (BCPLWORD) SDL_Init(SDL_INIT_EVERYTHING);
  // Enable Unicode translation of keyboard events.
  SDL_EnableUNICODE(1);
  SDL_JoystickEventState(SDL_ENABLE);
  printf("SDL_Init => %d\n", res);
}

printf("Calling bcm_host_init()\n");

bcm_host_init();

printf("Calling eglGetDisplay(..)\n");

// get an EGL display connection
state->display = eglGetDisplay(EGL_DEFAULT_DISPLAY);
if(state->display == EGL_NO_DISPLAY) {
    printf("ERROR: eglGetDisplay(..) failed\n");
    return 0;
}

// initialize the EGL display connection
printf("Calling eglInitialize(..)\n");
result = eglInitialize(state->display, NULL, NULL);
if(result != EGL_TRUE) {
    printf("ERROR: eglInitialize(..) failed\n");
    return 0;
}

// Query the EGL implementation
printf("Calling eglQueryString(..)\n");
{ const char *str = eglQueryString(state->display, EGL_CLIENT_APIS);
  printf("\nEGL_CLIENT_APIS = %s\n", str);
  str = eglQueryString(state->display, EGL_EXTENSIONS);
}

```

```

printf("EGL_EXTENSIONS = %s\n", str);
str = eglQueryString(state->display, EGL_VENDOR);
printf("EGL_VENDOR      = %s\n", str);
str = eglQueryString(state->display, EGL_VERSION);
printf("EGL_VERSION     = %s\n\n", str);
}

// Get an appropriate EGL frame buffer configuration
printf("Calling eglChooseConfig(..)\n");
result = eglChooseConfig(state->display, attribute_list, &config, 1, &num_config);
assert(EGL_FALSE != result);
check();

// Get an appropriate EGL frame buffer configuration
result = eglBindAPI(EGL_OPENGL_ES_API);
assert(EGL_FALSE != result);
check();

// Create an EGL rendering context
printf("Calling eglCreateContext(..)\n");
state->context = eglCreateContext(state->display, config, EGL_NO_CONTEXT, context_attr);
assert(state->context!=EGL_NO_CONTEXT);
check();

// Create an EGL window surface
printf("Calling graphics_get_display_size(..)\n");
success = graphics_get_display_size(0 /* LCD */, &state->screen_width, &state->screen_height);
assert( success >= 0 );

dst_rect.x = 0;
dst_rect.y = 0;
dst_rect.width = state->screen_width;
dst_rect.height = state->screen_height;

printf("width=%d height=%d\n", dst_rect.width, dst_rect.height);

src_rect.x = 0;
src_rect.y = 0;
src_rect.width = state->screen_width << 16;
src_rect.height = state->screen_height << 16;

printf("Calling vc_dispmanx_display_open(..)\n");

dispman_display = vc_dispmanx_display_open( 0 /* LCD */);
dispman_update = vc_dispmanx_update_start( 0 );

```

```

dispman_element = vc_dispmanx_element_add ( dispman_update, dispman_display,
    0/*layer*/, &dst_rect, 0/*src*/,
    &src_rect, DISPMANX_PROTECTION_NONE, 0 /*alpha*/, 0/*clamp*/, 0/*transform*/);

nativewindow.element = dispman_element;
nativewindow.width = state->screen_width;
nativewindow.height = state->screen_height;
vc_dispmanx_update_submit_sync( dispman_update );

check();

state->surface = eglCreateWindowSurface( state->display, config, &nativewindow, NULL );
assert(state->surface != EGL_NO_SURFACE);
check();

// Connect the context to the surface
result = eglMakeCurrent(state->display, state->surface, state->surface, state->context);
assert(EGL_FALSE != result);
check();

// Set background color and clear buffers
//glClearColor(0.15f, 0.25f, 0.35f, 1.0f);
glClearColor(0.95f, 0.65f, 0.35f, 1.0f);
glClear( GL_COLOR_BUFFER_BIT );

check();

eglSwapBuffers(state->display, state->surface);
check();

return -1;
}
#endif

#ifdef SDLavail
// This system is using SDL to call GL
{ int argc = 0;
  BCPLWORD res = (BCPLWORD) SDL_Init(SDL_INIT_EVERYTHING);
  //BCPLWORD res = 0; //(BCPLWORD) SDL_Init(SDL_INIT_VIDEO);
  if (res<0) {
    fprintf(stderr, "Video initialization failed: %s\n", "error");
// SDL_GetError());
    return 0;
    //SDL_Quit();

```

```

    }

    //printf("glfn: SDL_init returned ok\n");

    info = SDL_GetVideoInfo();

    if( !info ) {
        fprintf(stderr, "Video query failed: %s\n",
                SDL_GetError());
        SDL_Quit();
        exit(0);
    }

    bpp = info->vfmt->BitsPerPixel;
    printf("bpp=%d\n", bpp);

    SDL_GL_SetAttribute(SDL_GL_RED_SIZE, 5);
    SDL_GL_SetAttribute(SDL_GL_GREEN_SIZE, 5);
    SDL_GL_SetAttribute(SDL_GL_BLUE_SIZE, 5);
    SDL_GL_SetAttribute(SDL_GL_DEPTH_SIZE, 16);
    SDL_GL_SetAttribute(SDL_GL_DOUBLEBUFFER, 1);

    return -1;
}
#endif

    case gl_Quit:      // Shut down SDL
#ifdef SDLavail
    SDL_Quit();
#else
    printf("Calling eglTerminate(..)\n");
    eglTerminate(state->display);
#endif
    return -1;

#ifdef SDLavail

    /**
    case gl_GetError:  // str -- fill str with BCPL string for the latest SDL error
    { char *str = SDL_GetError();
      printf("sdl_GetError: %s\n", str);
      return c2b_str(str, a[1]); // Convert to BCPL string format
    }
    /**/

```

```

#endif

    case gl_MkScreen: // (title, width, height)

#ifdef EGLavail
    printf("EGLavail: gl_MkScreen does nothing\n");
    return -1; // Success
#endif

#ifdef SDLavail
    { char tmpstr[256];
      int i;
      char *title = (char *) (a[1]);
      SDL_Surface *scr;

      width = a[2];
      height = a[3];

      flags = SDL_OPENGL;

      printf("glfn: SDLavail: gl_MkScreen width=%d height=%d\n",
width, height);

      //printf("Calling SetVideoMode(%d, %d, %d, %8x)\n", a[1], a[2], a[3], a[4]);
      scr = SDL_SetVideoMode(width, height, bpp, flags);

      if(scr==0){
          fprintf(stderr, "Video mode set failed: %s\n",
              SDL_GetError());
          SDL_Quit();
          exit(0);
      }

      b2c_str(a[1], tmpstr);

      //printf("gl_MkScreen: title=%s width=%d height=%d\n",
//          tmpstr, a[2], a[3]);
      SDL_WM_SetCaption(tmpstr, 0);

      // Enable Unicode translation of keyboard events.
      SDL_EnableUNICODE(1);
      SDL_JoystickEventState(SDL_ENABLE);

      printf("gl_MkScreen: setting result2 height=%d\n", height);
      g[Gn_result2] = height;
    }
#endif

```

```

    printf("gl_MkScreen: returning width=%d\n", width);

    { SDL_Rect rect = {100, 200, 400, 300};
printf("\nfillrect: surface rect=(%d,%d,%d,%d) col=%8x\n",
        100, 200, 400, 300, 0x12345678);
SDL_FillRect((SDL_Surface*)(scr), &rect, 0x12345678);
    SDL_GL_SwapBuffers();

    }

    return width;
    //return (BCPLWORD) scr;
}
#endif

#ifdef GLavail
{ char tmpstr[256];
  int i;
  char *title = (char *)a[1];
  SDL_Surface *scr;

  width = a[2];
  height = a[3];

  printf("glfn: GLavail: gl_MkScreen width=%d height=%d\n",
width, height);

  //printf("Calling SetVideoMode(%d, %d, %d, %8x)\n", a[1], a[2], a[3], a[4]);
  scr = SDL_SetVideoMode(width, height, bpp, flags);

  if(scr==0){
    fprintf(stderr, "Video mode set failed: %s\n",
            SDL_GetError());
    SDL_Quit();
    exit(0);
  }

  b2c_str(a[1], tmpstr);

  //printf("gl_MkScreen: title=%s width=%d height=%d\n",
  //      tmpstr, a[2], a[3]);
  SDL_WM_SetCaption(tmpstr, 0);

  // Enable Unicode translation of keyboard events.
  SDL_EnableUNICODE(1);

```

```

SDL_JoystickEventState(SDL_ENABLE);

printf("gl_MkScreen: setting result2 height=%d\n", height);
g[Gn_result2] = height;
printf("gl_MkScreen: returning width=%d\n", width);

    { SDL_Rect rect = {100, 200, 400, 300};
printf("\nfillrect: surface rect=(%d,%d,%d,%d) col=%8x\n",
        100, 200, 400, 300, 0x12345678);
SDL_FillRect((SDL_Surface*)(scr), &rect, 0x12345678);
    SDL_GL_SwapBuffers();

    }

    return width;
    //return (BCPLWORD) scr;
}
#endif

case gl_MkProg: // ()
{ GLuint prog = glCreateProgram();
  //printf("glfn: glCreateProgram => %d\n", prog);
  return (BCPLWORD) prog;
}

case gl_CompileVshader: // (prog, cstr)
{ // Compiler the vertex shader whose source is in the
  // C string cstr, and attach it to the given GL program.
  GLuint prog = (GLuint) a[1];
  const char* cstr = (char *) (&W[a[2]]);

  GLuint Vshader = glCreateShader(GL_VERTEX_SHADER);

  glShaderSource(Vshader, 1, &cstr, NULL);
  glCompileShader(Vshader);

  GLint nCompileResult = 0;

  glGetShaderiv(Vshader, GL_COMPILE_STATUS, &nCompileResult);

  if(!nCompileResult)
  { int i;
    char Log[1024];
    GLint nLength;
    glGetShaderInfoLog(Vshader, 1024, &nLength, Log);

```



```

        for(i=0; i<nLength; i++) printf("%c", Log[i]);
        printf("\n");
    }

    glAttachShader(prog, Vshader);
    return Vshader;
}

case gl_CompileFshader: // (prog, cstr)
{ // Compiler the fragment shader whose source is in the
  // C string cstr, and attach it to the given GL program.
  GLuint prog = (GLuint) a[1];
  const char* cstr = (char *) (&W[a[2]]);
  GLuint Fshader = glCreateShader(GL_FRAGMENT_SHADER);

  glShaderSource(Fshader, 1, &cstr, NULL);
  glCompileShader(Fshader);

  GLint nCompileResult = 0;

  glGetShaderiv(Fshader, GL_COMPILE_STATUS, &nCompileResult);

  if(!nCompileResult)
  { int i;
    char Log[1024];
    GLint nLength=20;
    glGetShaderInfoLog(Fshader, 1024, &nLength, Log);
    for(i=0; i<nLength; i++) printf("%c", Log[i]);
    printf("\n");
  }

  glAttachShader(prog, Fshader);
  return Fshader;
}

case gl_LinkProgram: // (prog)
{ GLuint prog = (GLuint)a[1];
  glLinkProgram(prog);

  GLint nLinkResult = 0;

  glGetProgramiv(prog, GL_LINK_STATUS, &nLinkResult);

  if(!nLinkResult)
  { int i;

```

```

    char Log[1024];
    GLint nLength;
    glGetProgramInfoLog(prog, 1024, &nLength, Log);
    for(i=0; i<nLength; i++) printf("%c", Log[i]);
    printf("\n");
}
//printf("glfn: gl_LinkProgram returning -1\n");
return -1;
}

```

```
#ifdef XXX
```

```

    case gl_BindAttribLocation: // (prog, loc, name)
    { // Specify the location of an attribute before linking
        GLuint prog = (GLuint) a[1];
        GLuint loc = (GLuint) a[2];
        b2c_str(a[3], tmpstr);
        printf("glfn: BindAttribLocation prog=%d loc=%d name=%s\n", prog, loc, tmpstr);
        return (BCPLWORD) glBindAttribLocation(prog, loc, tmpstr);
    }

```

```

    case gl_Uniform1f: // (loc, x)
    { // Set 1 uniform element
        FN x;
        GLuint loc = (GLuint) a[1];
        x.i = a[2];
        printf("glfn: Uniform1f loc=%7d value=%6.3g\n", loc, (float)x.f);
        return (BCPLWORD) glUniform1f(loc, (float)x.f);
    }

```

```

    case gl_Uniform2f: // (loc, x, y)
    { // Set 2 uniform elements
        FN x;
        FN y;
        GLuint loc = (GLuint) a[1];
        x.i = a[2];
        y.i = a[3];
        //printf("glfn: Uniform2f loc=%7d values: %6.3g %6.3g\n",
        //      loc, x.f, y.f);
        return (BCPLWORD) glUniform2f(loc, (float)x.f, (float)y.f);
    }

```

```

    case gl_Uniform3f: // (loc, x, y, z)
    { // Set 3 uniform elements
        FN x;
        FN y;

```

```

    FN z;
    GLuint loc    = (GLuint) a[1];
    x.i = a[2];
    y.i = a[3];
    z.i = a[4];
    //printf("glfn: Uniform3f loc=%7d values: %6.3f %6.3f %6.3f\n",
    //      loc, x.f, y.f, z.f);
    //return (BCPLWORD) glUniform3f(loc, (float)x.f, (float)y.f, (float)z.f);
    return (BCPLWORD) glUniform3f(loc, 1.0f, 0.0f, 0.0f);
}

case gl_Uniform4f: // (loc, x, y, z, w)
{ // Set 4 uniform elements
    FN x;
    FN y;
    FN z;
    FN w;
    GLuint loc    = (GLuint) a[1];
    x.i = a[2];
    y.i = a[3];
    z.i = a[4];
    w.i = a[5];
    //printf("glfn: Uniform4f loc=%7d values: %6.3g %6.3g %6.3g %6.3g\n",
    //      loc, x.f, y.f, z.f, w.f);
    return (BCPLWORD) glUniform4f(loc, (float)x.f, (float)y.f, (float)z.f, (float)w.f);
}
#endif

case gl_GetAttribLocation: // (prog, name)
{ // Find out where the linker put an attribute variable
    GLuint prog = (GLuint) a[1];
    b2c_str(a[2], tmpstr);
    //printf("glfn: GetAttribLocation prog=%d name=%s\n", prog, tmpstr);
    return (BCPLWORD) glGetAttribLocation(prog, tmpstr);
}

case gl_GetUniformLocation: // (prog, name)
{ // Find out where the linker put a uniform variable
    GLuint prog = (GLuint) a[1];
    GLint loc;
    b2c_str(a[2], tmpstr);
    loc = glGetUniformLocation(prog, tmpstr);
    printf("glfn: GetAttribLocation prog=%d name=%s => loc=%d\n", prog, tmpstr, loc);
    return (BCPLWORD)loc;
}

```

```

case gl_UniformMatrix4fv: // (loc, prog, matrix) -- 4x4 matrix
{
    GLuint loc = (GLuint) a[1];
    GLuint prog = (GLuint) a[2];
    float *matrix = (float *) (&w[a[3]]);
    //int i;
    //for(i=0; i<16; i++) printf("%9.3f\n", matrix[i]);
    glUniformMatrix4fv(loc, prog, GL_FALSE, matrix);
    //return (BCPLWORD) glUniformMatrix4fv(loc, prog, GL_FALSE, matrix);
    return -1;
}

case gl_DeleteShader: // (shader)
{ GLuint shader = (GLuint) a[1];
  glDeleteShader(shader);
  return -1;
}

case gl_UseProgram: // (prog)
{ GLuint prog = (GLuint)a[1];
  glUseProgram(prog);
  return -1;
}

case gl_Enable: // (op)
{ GLint op = (GLint)a[1];
  glEnable(op);
  return -1;
}

case gl_Disable: // (op)
{ GLint op = (GLint)a[1];
  glDisable(op);
  return -1;
}

case gl_DepthFunc: // (relation)
{ GLint relation = (GLint)a[1];
  glDepthFunc(relation);
  return -1;
}

case gl_VertexData: // (loc, n, stride, datav))
{ // datav<32 the a vertex object is being used and datav is an offset

```

```

// The are n vertex items each containing stride floating point values
GLint loc = (GLint)a[1];
GLint n = (GLint)a[2];
GLint stride = (GLint)(a[3]*4);
GLfloat *datav = (GLfloat *)((0<=a[4] && a[4]<32) ? (const void *) (a[4]*4) : &W[a[4]
//int i;
//printf("glfn: calling glVertexAttribPointer loc=%d n=%d stride=%d a[4]=%d\n",
//      loc, n, stride, a[4]);
//printf("glfn: calling          glVertexAttribPointer loc=%d n=%d stride=%d a[4]=%d\n
//      loc, n, a[3], a[4]);

glVertexAttribPointer(loc,
                    n, GL_FLOAT,    // n elements of type float
                    GL_FALSE,     // Do not normalise
                    stride,        // Stride
                    datav);
glEnableVertexAttribArray(loc);
//printf("glfn: gl_VertexData loc=%d n=%d stride=%d\n", loc, n, stride);
//for(i = 0; i<3; i++) printf("%3d: %5.3f\n", i, datav[i]);
//printf("glfn: returned from glVertexAttribPointer loc=%d n=%d stride=%d a[4]=%d\n
//      loc, n, a[3], a[4]);
return -1;
}

case gl_DrawElements: // (mode, count, offset)
// mode   is 1=points, 2=lines, 3=linestrip, etc.
// count  is the number of index values.
// offset is the position in the index vector of the first
//        vertex to use.

{ BCPLWORD mode   = a[1];
  GLsizei count   = (GLsizei)(a[2]); // Number of index values to use.
  GLint*  offset  = (GLint*)(a[3]); // Offset (cast as a ptr) of the
                                   // first index element to use.

  GLenum  glmode  = 0;

  //      printf("DrawElements: mode=%d count=%d offset=%d\n",
  //            mode, a[2], a[3]);
  switch (mode) {
    default: return 0;

    case 1: glmode = GL_POINTS;      break;
    case 2: glmode = GL_LINES;      break;
    case 3: glmode = GL_LINE_STRIP; break;
    case 4: glmode = GL_LINE_LOOP;  break;
  }
}

```

```

        case 5: glmode = GL_TRIANGLES;      break;
        case 6: glmode = GL_TRIANGLE_STRIP; break;
        case 7: glmode = GL_TRIANGLE_FAN;   break;
    }

    glBindBuffer(GL_ELEMENT_ARRAY_BUFFER, 2); // 2 is the index buffer object
    glDrawElements(glmode,
                   count,                // Number of vertices
                   GL_UNSIGNED_SHORT,    // Type of index elements
                   offset);              // The position in bytes
                                         // (cast as a pointer) of
                                         // the first element of
                                         // the index vector to use.

    return -1; // Successful return
}

case gl_EnableVertexAttribArray: // (attrib)
{ GLint attrib = (GLint)a[1];
  //printf("glfn: EnableVertexAttribArray(%d)\n", attrib);
  glEnableVertexAttribArray(attrib);
  return -1;
}

case gl_DisableVertexAttribArray: // (attrib)
{ GLint attrib = (GLint)a[1];
  printf("glfn: DisableVertexAttribArray(%d)\n", attrib);
  glDisableVertexAttribArray(attrib);
  return -1;
}

case gl_GenVertexBuffer: // (size, data)
{ GLint size = (GLint)a[1]; // Number of floats
  GLfloat *data = (GLfloat *)&W[a[2]];
  GLuint buffer;
  glGenBuffers(1, &buffer);
  glBindBuffer(GL_ARRAY_BUFFER, buffer);
  glBufferData(GL_ARRAY_BUFFER, // Copy vertex data to graphics memory
               size * sizeof(GLfloat), // The size of data in bytes
               data, // The vertex data
               GL_STATIC_DRAW); // Usage hint
  return (BCPLWORD)buffer;
}

case gl_GenIndexBuffer: // (data, size)

```

```

{ GLushort *data = (GLushort *)&W[a[1]];
  GLint size = (GLint)a[2]; // Number of 16-bit indices
  GLuint buffer;
  //int i;
  //for(i=0; i<size; i++) printf("glfn: i=%2d index=%3d\n", i, data[i]);
  glGenBuffers(1, &buffer);
  glBindBuffer(GL_ELEMENT_ARRAY_BUFFER, buffer);
  //glEnable(GL_PRIMITIVE_RESTART); // Primitive restart seems not to work.
  //glPrimitiveRestartIndex(0xFFFF);
  glBufferData(GL_ELEMENT_ARRAY_BUFFER, // Copy index data to graphics memory
              size * sizeof(GLushort), // The size index data in bytes
              data, // The vertex data
              GL_STATIC_DRAW); // Usage hint
  return (BCPLWORD)buffer;
}

case gl_ClearColour: // (r, g, b, a)
  glClearColor(a[1]/255.0f, a[2]/255.0f, a[3]/255.0f, a[4]/255.0f);
  return -1;

case gl_ClearBuffer: // ()
  glClear(GL_COLOR_BUFFER_BIT | GL_DEPTH_BUFFER_BIT);
  //glClear(GL_COLOR_BUFFER_BIT);
  return -1;

#ifdef EGLavail
  case gl_SwapBuffers: // ()
    eglSwapBuffers(state->display, state->surface);
    check();
    return -1;
#endif

#ifdef SDLavail
  case gl_SwapBuffers: // ()
    SDL_GL_SwapBuffers();
    return -1;
#endif

#ifdef SDLavail
  case gl_pollevent: // (pointer) to [type, args, ... ] to hold details of
// the next event
  { SDL_Event test_event;
    if (SDL_PollEvent(&test_event))
      { decodeevent(&test_event, &W[a[1]]);
        return -1;
      }
}

```

```

    }
    decodeevent(0, &W[a[1]]);
    return 0;
}
#endif

#ifdef forRaspiGL
    // RaspiGL uses SDL to pollevents
    case gl_pollevent: // (pointer) to [type, args, ... ] to hold details of
// the next event
    { SDL_Event test_event;
      if (SDL_PollEvent(&test_event))
      { decodeevent(&test_event, &W[a[1]]);
        return -1;
      }
      decodeevent(0, &W[a[1]]);
      return 0;
    }
#endif

case gl_M4mulM4: // (A, B, C) performs C := A * B
{ float *A = (float *)&W[a[1]];
  float *B = (float *)&W[a[2]];
  float *C = (float *)&W[a[3]];
  float a00=A[ 0], a10=A[ 1], a20=A[ 2], a30=A[ 3];
  float a01=A[ 4], a11=A[ 5], a21=A[ 6], a31=A[ 7];
  float a02=A[ 8], a12=A[ 9], a22=A[10], a32=A[11];
  float a03=A[12], a13=A[13], a23=A[14], a33=A[15];

  float b00=B[ 0], b10=B[ 1], b20=B[ 2], b30=B[ 3];
  float b01=B[ 4], b11=B[ 5], b21=B[ 6], b31=B[ 7];
  float b02=B[ 8], b12=B[ 9], b22=B[10], b32=B[11];
  float b03=B[12], b13=B[13], b23=B[14], b33=B[15];

  //printf("gl_M4mulM4: entered %d %d %d\n", a[1], a[2], a[3]);

  //printf("%8.3f %8.3f %8.3f %8.3f \n", a00, a01, a02, a03);
  //printf("%8.3f %8.3f %8.3f %8.3f \n", a10, a11, a12, a13);
  //printf("%8.3f %8.3f %8.3f %8.3f \n", a20, a21, a22, a23);
  //printf("%8.3f %8.3f %8.3f %8.3f \n\n", a30, a31, a32, a33);

  //printf("%8.3f %8.3f %8.3f %8.3f \n", b00, b01, b02, b03);
  //printf("%8.3f %8.3f %8.3f %8.3f \n", b10, b11, b12, b13);
  //printf("%8.3f %8.3f %8.3f %8.3f \n", b20, b21, b22, b23);
  //printf("%8.3f %8.3f %8.3f %8.3f \n\n", b30, b31, b32, b33);

```



```

C[ 0] = a00*b00 + a01*b10 + a02*b20 + a03*b30; // c00
C[ 1] = a10*b00 + a11*b10 + a12*b20 + a13*b30; // c10
C[ 2] = a20*b00 + a21*b10 + a22*b20 + a23*b30; // c20
C[ 3] = a30*b00 + a31*b10 + a32*b20 + a33*b30; // c30

C[ 4] = a00*b01 + a01*b11 + a02*b21 + a03*b31; // c01
C[ 5] = a10*b01 + a11*b11 + a12*b21 + a13*b31; // c11
C[ 6] = a20*b01 + a21*b11 + a22*b21 + a23*b31; // c21
C[ 7] = a30*b01 + a31*b11 + a32*b21 + a33*b31; // c31

C[ 8] = a00*b02 + a01*b12 + a02*b22 + a03*b32; // c02
C[ 9] = a10*b02 + a11*b12 + a12*b22 + a13*b32; // c12
C[10] = a20*b02 + a21*b12 + a22*b22 + a23*b32; // c22
C[11] = a30*b02 + a31*b12 + a32*b22 + a33*b32; // c32

C[12] = a00*b03 + a01*b13 + a02*b23 + a03*b33; // c03
C[13] = a10*b03 + a11*b13 + a12*b23 + a13*b33; // c13
C[14] = a20*b03 + a21*b13 + a22*b23 + a23*b33; // c23
C[15] = a30*b03 + a31*b13 + a32*b23 + a33*b33; // c33

//printf("%8.3f %8.3f %8.3f %8.3f \n", C[0], C[4], C[ 8], C[12]);
//printf("%8.3f %8.3f %8.3f %8.3f \n", C[1], C[5], C[ 9], C[13]);
//printf("%8.3f %8.3f %8.3f %8.3f \n", C[2], C[6], C[10], C[14]);
//printf("%8.3f %8.3f %8.3f %8.3f \n\n", C[3], C[7], C[11], C[15]);
return 0;
}

case gl_M4mulV: // (A, B, C) performs C := A * B
                // where A is a 4x4 matrix and B and C are
                // 4 element vectors. B and C need not be distinct.
{ float *A = (float *)&W[a[1]];
  float *B = (float *)&W[a[2]];
  float *C = (float *)&W[a[3]];
  float a00=A[ 0], a10=A[ 1], a20=A[ 2], a30=A[ 3];
  float a01=A[ 4], a11=A[ 5], a21=A[ 6], a31=A[ 7];
  float a02=A[ 8], a12=A[ 9], a22=A[10], a32=A[11];
  float a03=A[12], a13=A[13], a23=A[14], a33=A[15];

  float b0=B[0], b1=B[1], b2=B[2], b3=B[3];
  C[0] = a00*b0 + a01*b1 + a02*b2 + a03*b3; // c0
  C[1] = a10*b0 + a11*b1 + a12*b2 + a13*b3; // c1
  C[2] = a20*b0 + a21*b1 + a22*b2 + a23*b3; // c2
  C[3] = a30*b0 + a31*b1 + a32*b2 + a33*b3; // c3

```

```

    return 0;
}

case gl_PrimitiveRestartIndex:
    { GLuint w = (GLuint)(a[1]);
      glEnable(GL_PRIMITIVE_RESTART);
      printf("PrimitiveRestart: w=%4x\n", w);
      glPrimitiveRestartIndex(w);
      return -1;
    }

case gl_ScreenSize: // (@xsize, @ysize)
    printf("glfn: gl_ScreenSize called\n");
#ifdef EGLavail
    W[a[2]] = state->screen_width;
    W[a[3]] = state->screen_height;
#endif
    return -1;

// Joystick functions
case gl_numjoysticks:
    return SDL_NumJoysticks();

case gl_joystickopen:      // 42 (index) => joy
    return (BCPLWORD)SDL_JoystickOpen(a[1]);

case gl_joystickclose:    // 43 (joy)
    SDL_JoystickClose((SDL_Joystick *)a[1]);
    return 0;

case gl_joystickname:     // 44 (index)
    { const char *name = SDL_JoystickName(a[1]);
      return c2b_str(name, a[1]);
    }

case gl_joysticknumaxes:  // 45 (joy)
    return SDL_JoystickNumAxes((SDL_Joystick*)a[1]);

case gl_joysticknumbuttons: // 46 (joy)
    return SDL_JoystickNumButtons((SDL_Joystick*)a[1]);

case gl_joysticknumballs: // 47 (joy)
    return SDL_JoystickNumBalls((SDL_Joystick*)a[1]);

```

```
case gl_joysticknumhats: // 47 (joy)
    return SDL_JoystickNumHats((SDL_Joystick*)a[1]);

case gl_joystickeventstate: //49 sdl_enable=1 or sdl_ignore=0
    return SDL_JoystickEventState(a[1]);

case gl_joystickgetbutton: // 55 (joy)
    return SDL_JoystickGetButton((SDL_Joystick*)a[1], a[2]);

case gl_joystickgetaxis: // 56 (joy)
    return SDL_JoystickGetAxis((SDL_Joystick*)a[1], a[2]);

case gl_joystickgethat: // 58 (joy)
    return SDL_JoystickGetHat((SDL_Joystick*)a[1], a[2]);

}
}
#endif
#endif
```

Appendix F

Package Installation Details

All the programs described in this documents are designed to run on the Raspberry Pi, but they can also run on almost any other machine including those running Linux, Windows or Mac OSX. The annoying problem is that you will have to install the relevant packages unless they are already present. This can be a daunting and error prone task unless you are already an experienced systems programmer. This appendix has been written, mainly for my benefit, to remind me of the packages I have used and how to install them on the various machines I have access to, namely, the Raspberry Pi, a laptop running either Ubuntu Linux or Windows and a Mac Mini running Mac OSX.

The documentation here is typically rather terse, consisting mainly of sequences of commands to install and check each package. Details of how install the packages under Windows will be added in due course.

F.0.1 Installing BCPL under Linux, the Raspberry Pi and Mac OSX

First obtain `bcpl.tgz` from my home page (www.cl.cam.ac.uk/~mr10) and place it in a directory called `~/Downloads`. Then type the following commands.

```
cd
mkdir distribution
cd distribution
tar zxvf ~/Downloads/bcpl.tgz
cd BCPL/cintcode
cp -r Elisp $HOME
cp .emacs $HOME
```

For Linux on my laptop I then type:

```
. os/linux/setbcplenv
```

```
make clean
make
c compall
```

For the Raspberry Pi, the BCPL system can be built by typing:

```
. os/linux/setbcplenv
make clean
make -f MakefileRaspi
c compall
```

For Mac OSX type:

```
. os/MacOSX/setbcplenv
make clean
make -f MakefileMacOSX
c compall
```

You might like to put `. $HOME/distribution/BCPL/cintcode/os/linux/setbcplenv` as a line in `.bashrc` so that the BCPL environment variables are properly set whenever you login. For the OSX replace `linux` by `MacOSX`.

F.0.2 Installing Emacs under Linux, the Raspberry Pi and Mac OSX

On these systems the `apt-get` command should be available. Before installing anything it is a good idea to type:

```
sudo apt-get update
```

Emacs can then be installed by typing:

```
sudo apt-get update
sudo apt-get install emacs
```

Note the file `~/.emacs` and directory `Elisp` have already been setup when BCPL was installed.

F.0.3 Installing SDL under Linux and the Raspberry Pi

This document originally used the SDL graphics library but since SDL2 is now available, I plan to use it instead since it has many advantages over the original SDL. Until this happens you may still need SDL and this can be installed under Linux or the Raspberry Pi by typing:

```
sudo apt-get update
sudo apt-get install libsdl1.2-dev libsdl-image1.2-dev
sudo apt-get install libsdl-mixer1.2-dev libsdl-ttf2.0-dev
```

To check that is now installed type the following:

```
ls -l /usr/local/bin/sdl-config
sdl-config --cflags --libs
ls /usr/local/include/SDL
ls /usr/local/lib/SDL
```

Having installed SDL you will need to build a version of the BCPL system that uses it. For Linux, this is done my typing:

```
cd $BCPLROOT
make -f MakefileSDL clean
make -f MakefileSDL
```

For the Raspberry Pi, type:

```
cd $BCPLROOT
make -f MakefileRaspiSDL clean
make -f MakefileRaspiSDL
```

You should now be able to run graphics programs such as `bucket` by typing:

```
cd
cd distribution/BCPL/bcplprogs/raspi
cintsys
c b bucket
bucket
```

Under Mac OSX, I only use SDL2.

F.0.4 Installing SDL2 under Linux and the Raspberry Pi

SDL2 is fairly new and is currently not installable using `apt-get` however its source code can be downloaded from www.libsdl.org. Obtain a file with a name such as `sdl2-2.0.3.tar.gz` and place it in `~/Downloads`. Then type:

```
cd ~/Downloads
tar zxvf SDL2-2.0.3.tar.gz
cd SDL2-2.0.3
./configure
```

A really useful document describing how to setup SDL2 under Linux can be found using a web search with keywords `SDL2 download for linux`. This document points out that the `./configure` step probably finds that some dependent packages are missing and it recommends running the following before attempting to compile SDL2.

```
sudo apt-get install build-essential xorg-dev libudev-dev
sudo apt-get install libts-dev libgl1-mesa-dev libglu1-mesa-dev
sudo apt-get install libasound2-dev libpulse-dev libopenal-dev
sudo apt-get install libogg-dev libvorbis-dev libaudiofile-dev
sudo apt-get install libpng12-dev libfreetype6-dev libusb-dev
sudo apt-get install libdbus-1-dev zlib1g-dev libdirectfb-dev
```

Type the following should now successfully compile SDL2.

```
./configure
make
```

Note the `./configure` creates the file `Makefile` used by `make`. Assuming the `make` step worked, SDL2 can now be installed in its proper place by typing:

```
sudo make install
```

To check that it worked, try typing:

```
sdl2-config --cflags --libs
ls /usr/local/include/SDL2
ls /usr/local/lib
```

The same approach should work on the Raspberry Pi, but I have not yet tried it. Apparently the compilation of SDL2 takes about 50 minutes so be patient.