

Digital Electronics
Part III – Practical Labs

Dr. I. J. Wassell

Hardware Labs

Introduction

- In the hardware lab you will:
 - Construct logic circuits on breadboards and test them
 - Design logic circuits and implement them using
 - Logic gates (SSI) and counter chips (MSI) logic
 - Memory devices (VLSI)
 - Programmable array logic (PAL) type devices – specifically Generic array logic (GAL)

Introduction

- In the labs you will make use of the self-contained Prototyping Box
- Contains:
 - Breadboard to build the circuits on
 - A power supply (PSU) – 5V
 - Clock signal (square wave) generator
 - Switches
 - Conventional push switches
 - Ones giving logic outputs for input to circuits
 - LEDs and displays for showing outputs

Prototyping Box

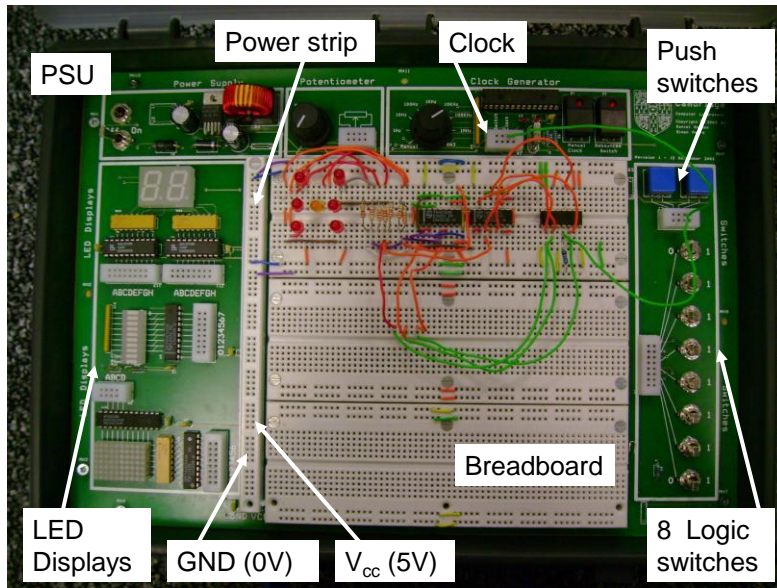

Breadboard

Horizontal strips used to distribute V_{cc} (5V) and GND (0V)

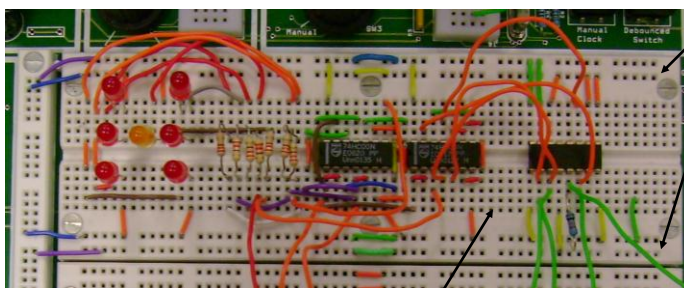

Vertical five hole strips used to connect up components

DIL Package

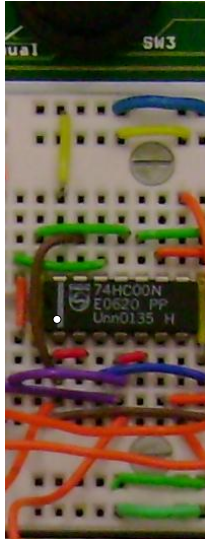

14-pin Dual in Line (DIL) package.
74HC00 device contains 4, 2-input
NAND Gates where:

74 identifies the series

HC identifies the technology

00 identifies the function

Pin numbering – White dot indicates
pin 1. Numbering increments as we
move in an anticlockwise direction
around the package

For 14(16) pin packages, pin 7(8)
is usually GND (0V) and pin 14(16)
 V_{CC} (5V). However, there are exceptions!

Wiring

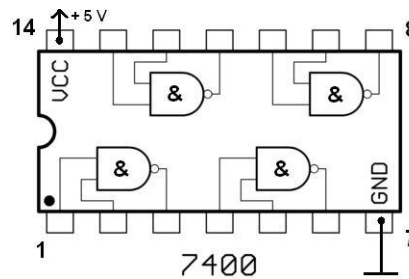
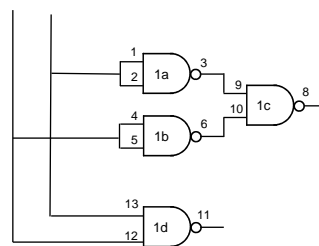
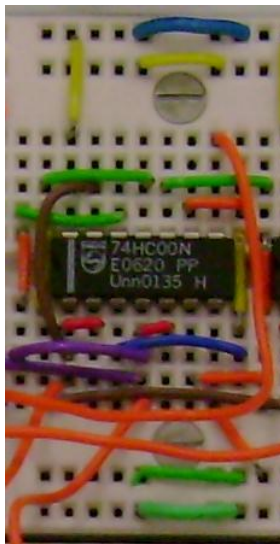

Testing - Scope

- An oscilloscope (or scope) is a fundamental item used when testing electronic circuits.
- It allows the voltage at a point in a circuit to be displayed as a function of time.

Voltage
(Volts/division)
'VERTICAL'

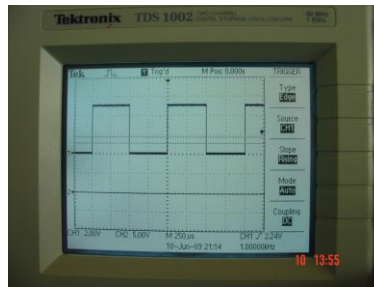

Time
'HORIZONTAL' (Seconds/division)

2 Channel Scope

- Front panel controls

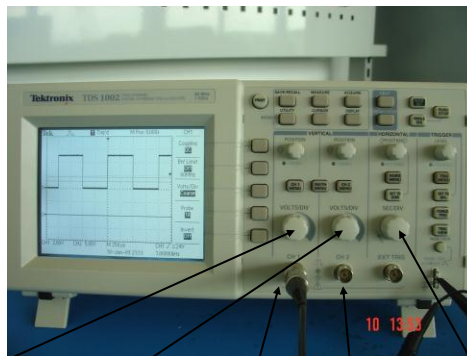

'VERTICAL' Channel 1 (Volts/division)
'VERTICAL' Channel 2 (Volts/division)
Channel 1 Input
Channel 2 Input
'HORIZONTAL' Time (Seconds/division)

2 Channel Scope

- So we adjust:
 - Volts/Div. to suit the amplitude of the input signal
 - Sec./Div. to suit the repetition rate (i.e., period or frequency) of the input signal
- The scope is primarily designed for displaying repetitive signals such as the square wave shown in the preceding pictures
- However, for such a signal to be displayed clearly, the scope must be 'Triggered' properly
 - This is done using the 'Trigger' front panel controls

2 Channel Scope

- Triggering:

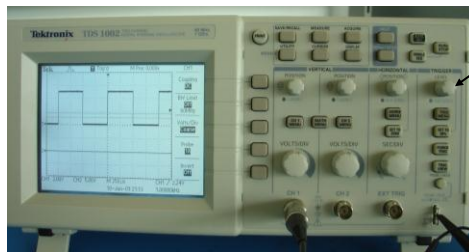

- The trigger level knob is adjusted to ensure that the trace becomes stable on the screen
 - NOTE: Ensure that the trigger source is set to the channel of interest (in this case Ch1)

2 Channel Scope

- Triggering:

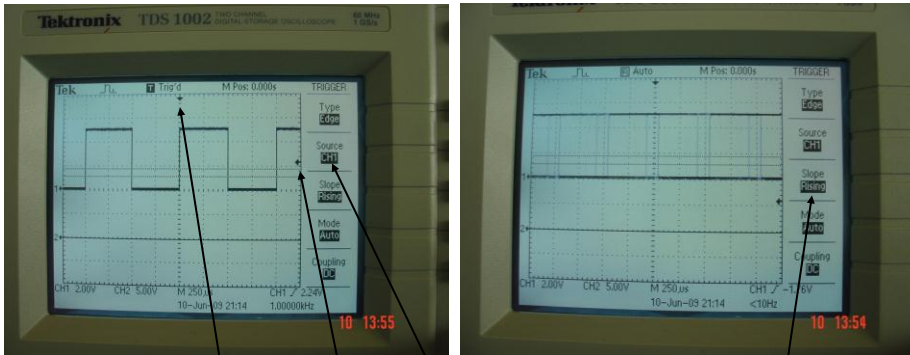

Triggered

Arrow shows
trigger point

Arrow shows
trigger level

Not Triggered

Trigger source,
i.e., Ch1

Trigger on rising
edge

2 Channel Scope

- Other issues: Channel settings

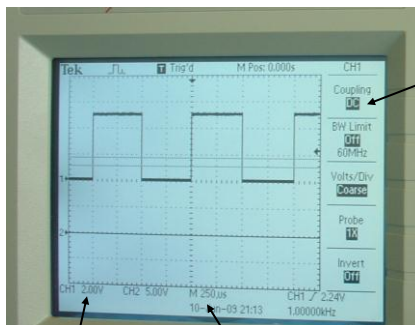

Ch1 setting, i.e.,
2V per div.

Timebase setting
i.e., 250us per div.

Use '**DC coupling**' – if you use '**AC coupling**' you will not be able to measure absolute voltage levels, i.e., do we have voltage levels representing 1s or 0s.

Other possible setting is '**GND**' which effectively disconnects the circuit under test and applies a short circuit across the scope input.

Testing - Tips

- Make sure 5V and GND connections are made to each IC package.
 - CMOS circuits can power up from their gate inputs giving all kinds of odd behaviour!
- Ensure all unused gate inputs on an IC package are connected to GND.
 - CMOS circuits have a very high input resistance, hence any small currents they pick up can be translated into voltages that can cause random switching of the gate. This can give rise to high power consumption and miss operation of the other gates on the same package.
- Make sure scope probe GND is connected to GND of circuit under test.