

String Diagrammatic Electrical Circuit Theory

Guillaume Boisseau

University of Oxford, UK*

Paweł Sobociński

Tallinn University of Technology, Estonia†

We develop a comprehensive string diagrammatic treatment of electrical circuits. Building on previous, limited case studies, we introduce controlled sources and meters as elements, and the *impedance calculus*, a powerful toolbox for diagrammatic reasoning on circuit diagrams. We demonstrate the power of our approach by giving comprehensive proofs of several textbook results, including the superposition theorem and Thévenin’s theorem.

1 Introduction

Classical electrical circuit theory [7], and the ubiquitous use of electrical circuits in the daily life of an engineer are testament to their power as a compositional, diagrammatic abstraction, denoting actual physical systems while at the same time intuitively reflecting network interconnections. Like other formalisms (e.g. signal flow graphs), theorems about circuits are proved by translating them—sometimes not entirely faithfully—to more traditional mathematics, with linear algebra playing a particularly important role, and compositionality taking a back seat. Nevertheless, *diagrammatic reasoning* at the level of circuits is the remit of several classical theorems, e.g. Thévenin’s theorem or Norton’s theorem.

We build on recent work [1, 6, 3] that treats circuits compositionally. In particular, we use Coxa’s semantics [6] that captures non-passive elements such as sources, which was subsequently axiomatised in the string-diagrammatic setting of Graphical Affine Algebra (GAA) [3], also building on the categorical approach to relational algebra developed by Carboni and Walters [5].

This is our starting point. Staying with affine relations as our ambient denotational universe, we enlarge the set of basic electrical elements with *controlled sources* and *meters*: voltmeters and ammeters. This lets us study both open and *closed* circuits; the latter have been ignored in existing compositional approaches since a closed circuit has only two possible denotations as an affine relation.

Our second innovation is what we call the *impedance calculus*. GAA and circuit syntax are intermingled via the use of *impedance boxes*: circuit elements that hold within them a GAA diagram. They reveal the symmetries of classical circuit elements more clearly than ordinary GAA diagrams, but they are more than just of aesthetic value. Indeed, they allow us to solve another common problem of string diagrammatic approaches: having to deal with large diagrams. Using the algebra of impedance boxes allows us to “compile” parts of the circuit to GAA, simplify, and translate back into circuit syntax, dramatically reducing the complexity of diagrammatic reasoning when solving typical textbook circuit problems.

Armed with our richer set of circuits and the impedance calculus, we are able to prove most of the well-known textbook (e.g. [7]) theorems of elementary circuit theory. For space reasons we have not been able to include many; nevertheless, we hope that the assortment on offer will give the reader a taste of the power of diagrammatic reasoning with the impedance calculus. On the one hand, the diagrammatic syntax allows for rigorous yet elegant statements of results about circuits, often revealing the underlying

*Funded by the EPSRC

†Supported by the ESF funded Estonian IT Academy research measure (project 2014-2020.4.05.19-0001) and the Estonian Research Council grant PRG1210.

symmetries – e.g. the independent measurement principle (Theorem 5) vs the Superposition Theorem (Theorem 6); the principle of relativity of potentials (Proposition 7) vs the principle of conservation of currents (Proposition 8). On the other, we show that the compositional framework—with its use of diagrammatic reasoning and the algebra of cartesian and abelian categories of relations—leads to elegant and rigorous proofs. Unfortunately, most have been moved to the appendix because of space restrictions.

2 Graphical Affine Algebra and Electrical Circuits

We begin with the basics of Graphical Linear Algebra (GLA) with its equational theory of Interacting Hopf Algebras (IIIH) [4]. Fix a field k . GLA is a string diagrammatic syntax, which organises itself as the arrows of the free prop GLA_k over the following monoidal signature:

$$\{ \text{---}\bullet, \text{---}\bullet\text{---}, \text{---}\boxed{k}\text{---}, \text{---}\text{---}\text{---}, \text{---}\circ\text{---}, \quad (1)$$

$$\bullet\text{---}, \text{---}\text{---}\text{---}, \text{---}\boxed{k}\text{---}, \text{---}\text{---}\text{---}, \text{---}\circ\text{---} \} \quad (2)$$

where $k \in k$ is a *scalar*. Intuitively the black structure can be thought of as *copying*, the white as *adding*. This is borne out by the intended semantics, which we describe next.

The prop of *linear relations* LinRel_k has as arrows $m \rightarrow n$ relations $R \subseteq k^m \times k^n$, which are k vector spaces; i.e. closed under k -linear combinations. In other words, arrows $m \rightarrow n$ are linear subspaces of $k^m \times k^n$, considered as a k -vector space. Composition is standard relational composition, $R ; S = \{ (u, w) \mid \exists v. (u, v) \in R \wedge (v, w) \in S \}$. It is simple to show linear relations are closed under composition.

The semantics of GLA is a prop morphism $[-]_k : \text{GLA}_k \rightarrow \text{LinRel}_k$. Since GLA_k is free, it is enough to describe its action on the generators. We do so below for the generators in 1; the corresponding generators in 2 are sent to the opposite relations. In each case the variables range over k .

$$\begin{aligned} [-\bullet]_k &= \{ (x, \binom{x}{x}) \}, & [-\bullet]_k &= \{ (x, \bullet) \}, & [-\boxed{k}]_k &= \{ (x, kx) \}, \\ [-\text{---}\text{---}\text{---}]_k &= \{ (\binom{x}{y}, x+y) \}, & [-\circ]_k &= \{ (\bullet, 0) \} \end{aligned}$$

The associated theory IIIH characterises linear relations. We give a brief overview below:

- both monoids $(\text{---}\bullet\text{---}, \bullet\text{---})$ $(\text{---}\text{---}\text{---}, \text{---}\text{---}\text{---})$ and comonoids $(\text{---}\bullet\text{---}, \text{---}\bullet)$, $(\text{---}\text{---}\text{---}, \text{---}\text{---}\text{---})$ are commutative
- monoids and comonoids of the opposite colour satisfy the equations of commutative bialgebras
- monoids and comonoids of the same colour satisfy the extra special Frobenius equations
- to pass between black and white cups and caps is to compose with -1 . We shall often draw the -1 scalar as $-\blacksquare-$.
- all non-zero scalars are invertible, with the inverse of $-\boxed{k}-$ given by $-\overline{k}-$ for $k \neq 0$.

Graphical Affine Algebra was introduced in [3], extending the expressivity of GLA to affine relations. Let us recall the main concepts. A *translation* $v + V$ of a linear subspace V by a vector v is the set $v + V = \{ v + w \mid w \in V \}$. An *affine subspace* W is either empty, or it is the translation $v + V$ for some vector v and subspace V . Note that the empty set is an affine subspace, but it is *not* a linear subspace.

The prop of affine relations AffRel_k has as affine subspaces of $k^m \times k^n$ as arrows $m \rightarrow n$. It is the case that the composition of two affine relations yields an affine relation, and can be shown using the notion of homogenisation [3, Proposition 6], but we will not delve into the details here.

On the syntactic side, we extend the signature (1), (2) with a single generator

$$\text{---} \quad (3)$$

obtaining a richer string diagrammatic syntax as the arrows of the free prop GAA. Abusing notation, the semantics $[-]_k : \text{GAA} \rightarrow \text{AffRel}_k$ is defined the same way as for GLA on the shared generators, and $[-]_k = \{(\bullet, 1)\}$. To characterise AffRel_k we add the following equations:

$$\begin{array}{c} \text{---} \curvearrowright \text{---} \\ \text{---} \end{array} \stackrel{(\text{dup})}{=} \begin{array}{c} \text{---} \\ \text{---} \end{array} \quad \begin{array}{c} \text{---} \bullet \\ \text{---} \end{array} \stackrel{(\text{del})}{=} \square \quad \begin{array}{c} \text{---} \circ \\ \text{---} \end{array} \stackrel{(\text{empty})}{=} \begin{array}{c} \text{---} \bullet \bullet \\ \text{---} \end{array}$$

Instead of using relying purely on equational reasoning, it is often convenient to work with inequations, which can lead to shorter calculations, and allow us to identify some interesting, higher-level categorical structures. Instead of working with ordinary props, one works with *ordered* props, that is props enriched over the category of posets. Similarly any equational theory can be presented as an *inequational* theory in the obvious way, by replacing an equation by two inequations.

Indeed, LinRel_k and AffRel_k can be considered as ordered props by using set-theoretical inclusion of relations as the homset order. On the syntactic side, it suffices [2] to add a single inequation:

$$\circ \text{---} \leq \bullet \text{---}$$

The ordered setting also lends itself to higher level reasoning schema, in particular, LinRel_k is an abelian bicategory of relations and AffRel_k is a cartesian bicategory of relations, concepts developed in [5].

2.1 The prop of electrical circuits and its semantics

We recall the string diagrammatic development of electrical circuits from [3], with minor modifications to suit our development in subsequent sections. The prop ECirc is free on the following signature:

$$\left\{ \begin{array}{c} \overset{R}{\text{---}} \\ \text{---} \end{array}, \begin{array}{c} \overset{V}{\text{---}} \\ \text{---} \end{array}, \begin{array}{c} \overset{I}{\text{---}} \\ \text{---} \end{array}, \begin{array}{c} \overset{L}{\text{---}} \\ \text{---} \end{array}, \begin{array}{c} \overset{C}{\text{---}} \\ \text{---} \end{array} \right\}_{R,L,C \in \mathbb{R}_+, V,I \in \mathbb{R}} \cup \left\{ \begin{array}{c} \text{---} \square \\ \text{---} \end{array}, \begin{array}{c} \text{---} \bullet \\ \text{---} \end{array}, \begin{array}{c} \text{---} \square \\ \text{---} \end{array}, \begin{array}{c} \text{---} \bullet \\ \text{---} \end{array} \right\} \quad (4)$$

where the parameters range over the reals. Arrows $m \rightarrow n$ of ECirc represent open linear electrical circuits with m open terminals on the left and n open terminals on the right. Generator $\overset{R}{\text{---}}$ represents a *resistor*, $\overset{V}{\text{---}}$ a *voltage source*, $\overset{I}{\text{---}}$ a *current source*, $\overset{L}{\text{---}}$ an *inductor* and $\overset{C}{\text{---}}$ a *capacitor*.

Circuits in ECirc are translated to GAA over $\mathbb{R}(x)$: the field of fractions of polynomials with real coefficients (see [6, 3]). The semantics is a strict monoidal functor $\mathcal{J} : \text{ECirc} \rightarrow \text{GAA}$ where, on objects $\mathcal{J}(1) = 2$: the idea is that every electrical wire is represented by *two* GAA wires, from top to bottom, the voltage wire and the current wire. We give the semantics in Figure 1, by showing the action on generators. Given circuits c, d of ECirc we write $c \stackrel{\mathcal{J}}{=} d$ when $\mathcal{J}(c) = \mathcal{J}(d)$ (in the equational theory of GAA, or equivalently as affine relations in $\text{AffRel}_{\mathbb{R}(x)}$). Similarly, we write $c \stackrel{\mathcal{J}}{\leq} d$ when $\mathcal{J}(c) \leq \mathcal{J}(d)$.

3 The Impedance Calculus

We now exploit a pattern of the semantics in Figure 1 to simplify the passage between circuits and GAA. This results in the *impedance calculus*, which can be used to simplify diagrammatic reasoning on circuits.

We extend the syntax (4) of ECirc with *impedance boxes*—illustrated below left—parametrised wrt arbitrary GAA circuits of type $(1, 1)$: that is, with one wire on the left and one on the right. We then

(ii) Reversing the direction of voltage and current sources flips polarities:



The impedance calculus is useful for proving circuit equivalences. The following proposition are just a few examples of classic equivalences one would find in any textbook.

Proposition 3.

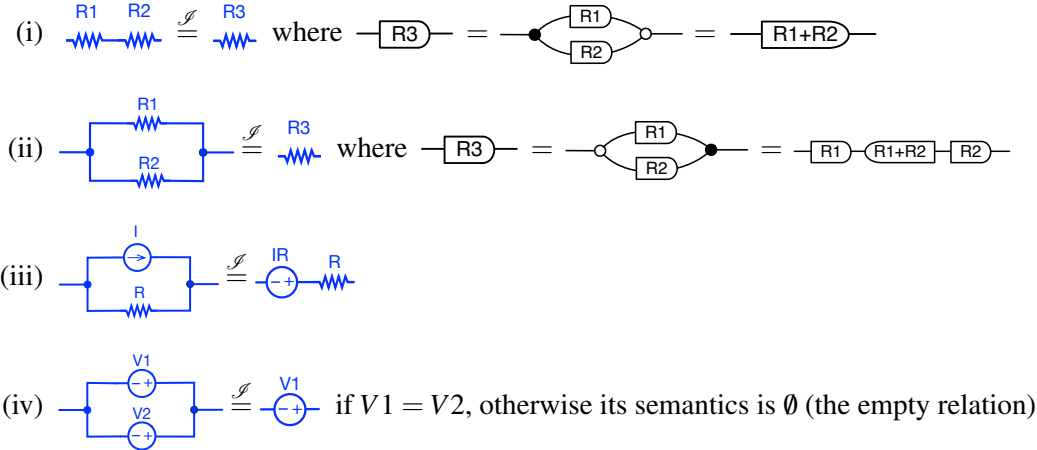

It is useful to contrast our treatment with the classical approach. Parts (i) and (iii) are standard and often-used equivalences. Part (ii) is known classically, but $R3$ is typically given a formula like $R1R2/(R1 + R2)$. Classical formulas, however, don't work for all values of $R1$ and $R2$, whereas the graphical one does. Given that it mirrors the case for resistors in series, we argue that the graphical formula is the more natural one. Finally, in (iv), the empty case is usually excluded by classical treatments. A textbook deems such a circuit *degenerate* and ignores that case when proving theorems. In GAA however, the empty relation is first-class and our theorems uniformly also include the empty case.

Proof. Part (i) is a simple exercise in the use of the impedance calculus:

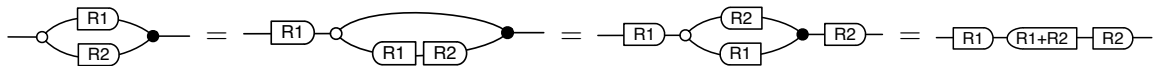
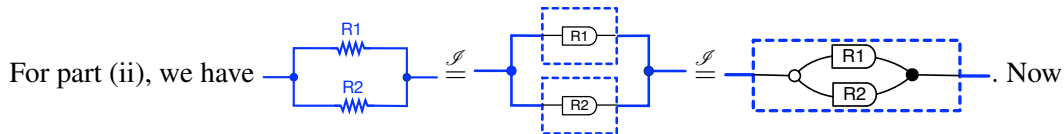
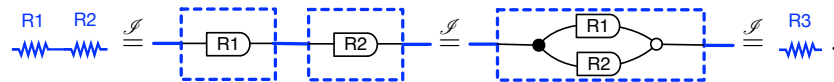

extracts the classical formula: because $R1$ and $R2$ are nonnegative, either $R1 + R2 \neq 0$, and $\text{---}R1+R2\text{---}$ is a scalar, or $R1 = R2 = 0$, and the formula is equal to 0. In both cases the result is a scalar.

Part (iii) is another simple calculation:

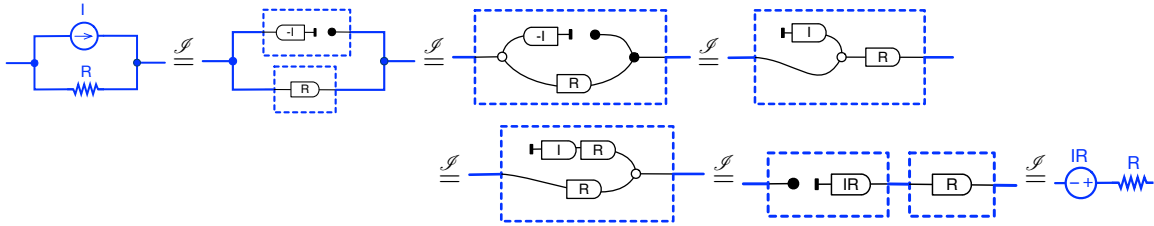

For part (iv), we can simplify using the impedance calculus as follows:

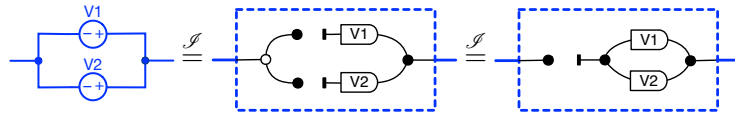

Now $\begin{array}{c} \text{V1} \\ \text{V2} \end{array}$ is just $V1$ if $V1 = V2$, and $\text{---} \text{---}$ otherwise. In that case, the circuit evaluates to $\begin{array}{c} \text{---} \\ \text{---} \end{array}$ which is denoted by the empty relation. \square

We shall see that, as a consequence of our Representation Theorem (Theorem 9), *any* (\bullet, \bullet) circuit can be represented by an impedance box.

4 Measuring Closed Circuits

Thus far, we have kept the language of circuits ECirc and the language of GAA neatly separated by impedance boxes (5) and the prop morphism $\mathcal{I}(\cdot) : \text{ECirc} \rightarrow \text{GAA}$. It's time to tear down the wall.

While impedance boxes are useful for open circuit calculations, engineers often study closed circuits. The problem is that these are mapped to $0 \rightarrow 0$ affine relations, and there are only two: the singleton and the empty set. In other words, the mapping only tells us whether the circuit has a solution, and nothing else. Indeed, no interesting behavior can be observed in a closed circuit in our existing framework.

Classically, a closed circuit is annotated with names for the currents and voltage differences of interest. In some presentations voltmeters and ammeters are even added as explicit elements. This is exactly what we do: add meters to our syntax. Instead of assigning names, however, our meters have an outgoing "information" wire, thought of as an ordinary GAA wire. Information wires allow us to probe closed circuits, i.e. those with no open *electric* wires, and to state and prove several theorems of circuit theory. Our diagrams will now have two types of wires: electric wires and information wires. Instead of keeping the props ECirc and GAA separate, we unite the two and work with a coloured (multisorted) prop EECirc .

The coloured prop EECirc has as objects words over the alphabet $\{\bullet, \bullet\}$. It is freely generated by the union of all the generators ((1), (2), (3)) of GAA , the generators (4) of ECirc , and the following:

$$\left\{ \begin{array}{c} \text{---} \\ \text{---} \end{array} \text{---} \text{---}, \begin{array}{c} \text{---} \\ \text{---} \end{array} \text{---} \text{---}, \begin{array}{c} \text{---} \\ \text{---} \end{array} \text{---} \text{---}, \begin{array}{c} \text{---} \\ \text{---} \end{array} \text{---} \text{---}, \begin{array}{c} \text{---} \\ \text{---} \end{array} \text{---} \text{---} \text{---} \end{array} \}_{m,n \in \mathbb{N}, c: m+1 \rightarrow n+1 \text{ in } \text{GAA}}$$

These are a *voltmeter* $\begin{array}{c} \text{---} \\ \text{---} \end{array} \text{---} : (\bullet, \bullet\bullet)$, *ammeter* $\begin{array}{c} \text{---} \\ \text{---} \end{array} \text{---} : (\bullet, \bullet\bullet)$, *controlled voltage source* $\begin{array}{c} \text{---} \\ \text{---} \end{array} \text{---} : (\bullet\bullet, \bullet)$, *controlled current source* $\begin{array}{c} \text{---} \\ \text{---} \end{array} \text{---} : (\bullet\bullet, \bullet)$ and a *generalised impedance box* $(\bullet^m \bullet, \bullet^n \bullet)$, parametrised over arbitrary GAA diagrams $c : m+1 \rightarrow n+1$.

We abuse notation and denote the translation of EECirc to GAA by $\mathcal{I} : \text{EECirc} \rightarrow \text{GAA}$. On objects, $\mathcal{I}(\bullet) = 2$, since—as before—en electrical wire is represented by two wires in GAA, but the information wire “is” a GAA wire, i.e. $\mathcal{I}(\bullet) = 1$. Next, \mathcal{I} acts on the generators of GAA as identity and on the basic electrical components (4) as described in Figure 1. We delay the translations of $\{ \text{V}, \text{A}, \text{+}, \text{-} \}$ to later in this section and first focus on the generalised impedance boxes. Their translation is:

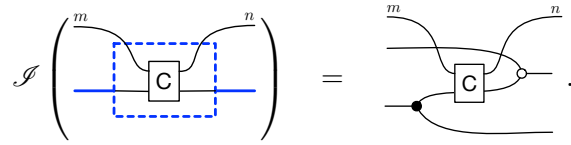

We again use $\stackrel{\mathcal{I}}{=}$ and $\stackrel{\mathcal{I}}{\leq}$ as circuit relations to mean $=$ and \leq on their translations to GAA, using its (in)equational theory. The properties of Lemma 1 easily generalise to these extended impedance boxes. We omit the details, and only mention one simple, but useful fact: GAA diagrams can breach impedance boxes. Suppose that $d : m \rightarrow m', e : n \rightarrow n'$ in EECirc are built up using only the GAA generators, then:

Observation 4.

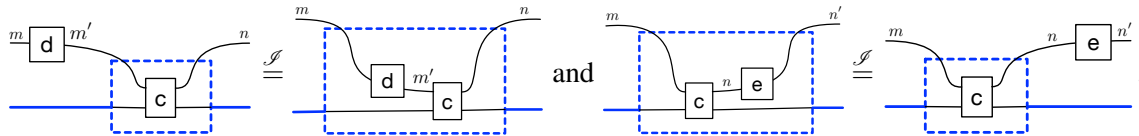

4.1 Meters and controlled sources

We now turn to the translations of the voltmeter and the ammeter.



Note that orientation follows the conventions used so far: current and voltage difference are right to left.

We can finally observe the behavior of closed circuits! Consider a simple circuit, with just a battery and a resistor. Having no open electrical wires, it is closed, but has one outgoing information wire. Mapping to GAA, we get a diagram with one output, giving us the computed value for the current.

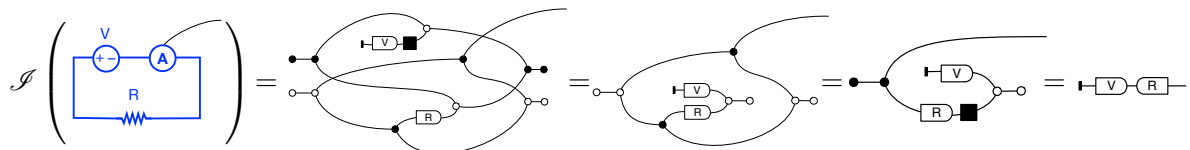

Although elementary enough above, these kinds of calculations can be drastically simplified using the impedance calculus by keeping the GAA diagrams small, as we shall demonstrate below.

First let us turn to controlled sources. Those are like independent sources, but their value is controlled by an information wire. Their translations to GAA are given below.

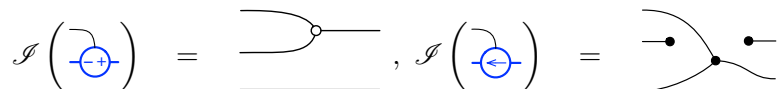

As in the previous section, it's usually simpler to combine impedances directly rather than map fully to GAA. This can be extended to work with meters too, giving a convenient way to solve many circuits. Using the generalised impedance boxes, we have:

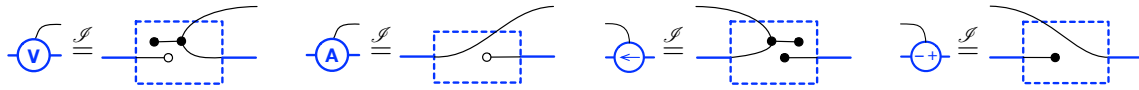

We can redo our simple example using this new technology:

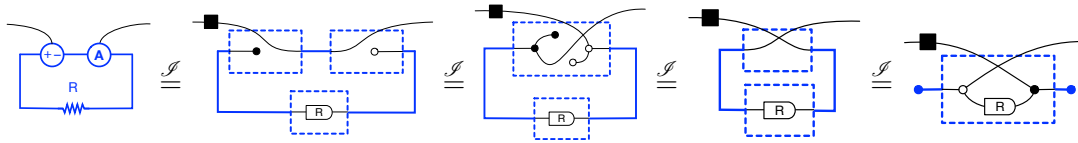

and so

$$\mathcal{I} \left(\begin{array}{c} \text{Circuit with source, ammeter, and resistor } R \end{array} \right) = \text{Simplified circuit} = R$$

An important property of meters and sources is that they can be considered one at a time. This is often used classically to keep calculations manageable. The following two theorems make this precise.

4.2 Independent Measurement Theorem

The first theorem is quite intuitive: measuring somewhere in a circuit ought not to affect measurements elsewhere. In other words, we can extract the full behavior of a circuit by considering measurements one at a time. In fact, this is so natural that it is just assumed to be true classically, and not mentioned in textbooks. We are being more rigorous here: the result is more subtle than one might think.

To get a single measurement we discard (plug $\bullet \rightarrow$ into) all meters but one. It is easy to show that an ignored ammeter is equivalent to a wire, and an ignored voltmeter to an open circuit.



Theorem 5 (Independent Measurement Theorem). Given a closed circuit C with n meter outputs, the behavior of the n measurements simultaneously is a subset of the behavior of one measurement at a time, ignoring the others. The proof is a simple derivation, using cartesian bicategory structure:

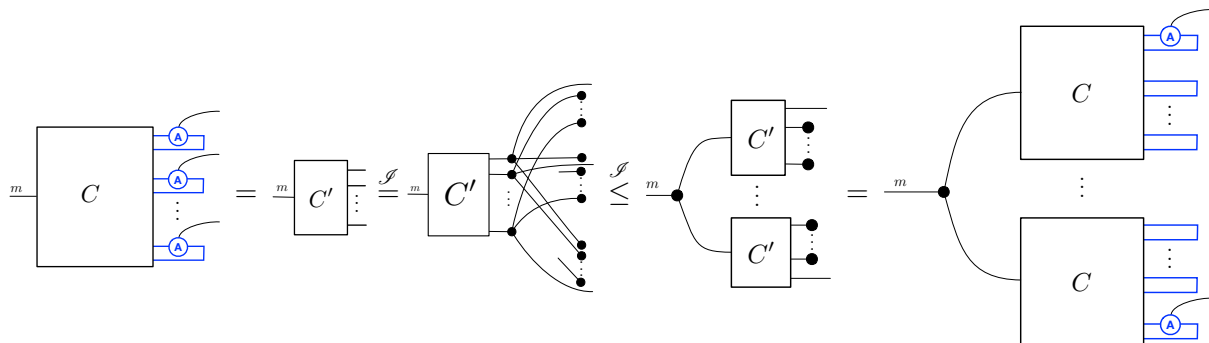

The diagram above illustrates this for ammeters, but it applies to any mixture of meters, remembering that a discarded voltmeter is an open circuit. If moreover each individual measurement is a function of the inputs (i.e. single-valued and total), then the inclusion is an equality.

The inclusion above is an equality for all “well-behaved” circuits. Classically, equality is postulated. It is, of course, reasonable to do so: if the inclusion is strict, it must be the case that either (i) that some meter can return a nonzero value with all sources off, i.e. it is not measuring anything physical, or (ii) that some settings of the sources are disallowed and can cause the semantics to be empty, which is degenerate. For example, in the following example we have accidentally short-circuited the source, meaning that we can’t turn it on with a nonzero value. This, indeed, is a degenerate case and we don’t have equality.

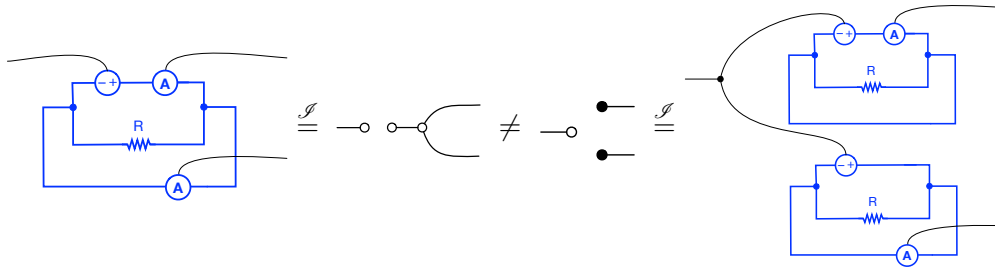

It does not appear easy to characterise graphically the circuits with such behavior. Instead we give the result in its general form, trusting that equality is easy to notice when calculating the right-hand side.

4.3 Superposition Theorem

The second theorem is amongst the most useful results of classical circuit theory. The superposition theorem ensures that the behavior of a circuit with multiple source can be calculated from its behaviors with one source turned on at a time.

To do this, we set all sources but one to zero by plugging $\circ-$. It is easy to show that a zero current source is equivalent to an open circuit, and a zero voltage source is equivalent to a plain wire.



In a precise sense it’s the dual of the independent measurement theorem: they are related by swapping colors and vertical reflection, which is a powerful operation of GLA that often generates elegant dualities.

Theorem 6 (Superposition Theorem). The behaviour of closed circuit C with m source inputs and no independent sources is a superset of the sum of its behaviors with one source turned on at a time:

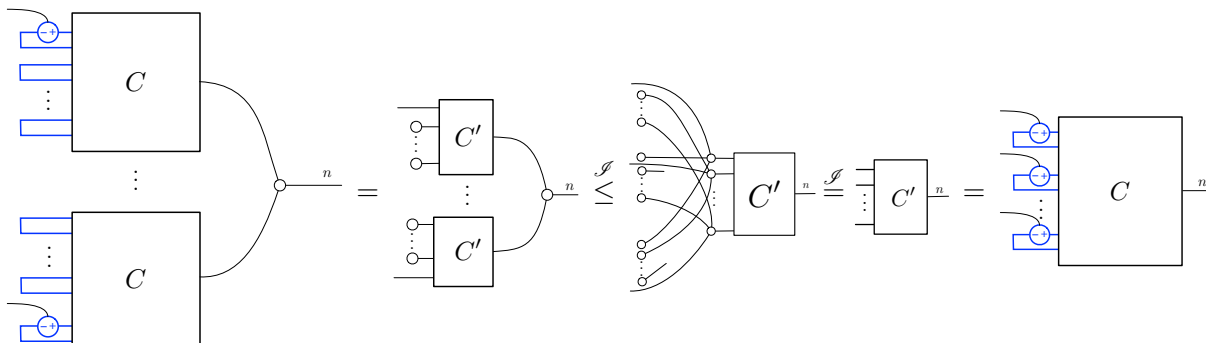

The diagram illustrates this with voltage sources, but it applies to any mixture of sources, given that a turned off current source is an open circuit. If moreover the outputs are a function (i.e. single-valued and total) of each source when activated individually, then the inclusion is an equality.

Proof. Since C has no independent sources, its mapping to GAA lands in the GLA fragment. Thus we can transpose (color-swap and flip) the result from the independent measurement theorem, noting that being a function is a self-transpose property, and color-swap reverses the direction of inclusion. Alternatively, one can use the fact that GLA modulo its inequational theory is an abelian category of relations [5]. \square

The analysis of the equality case in the previous section also applies here via the duality. Note that the theorem as stated forbids independent sources. However it's easy to extend it to work with them too:

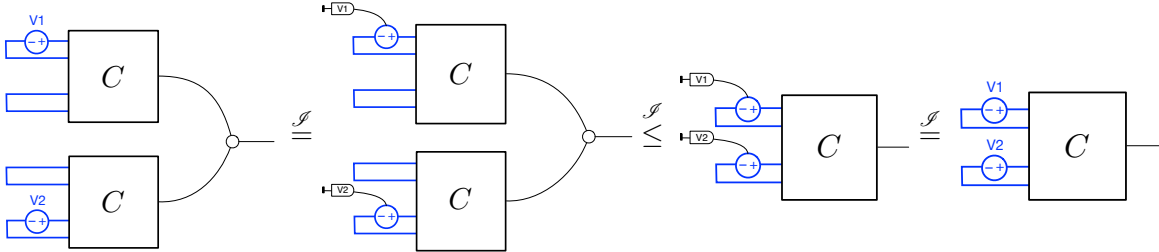

5 Structural theorems

We conclude with three results that showcase the graphical language's power to state and prove non-trivial invariants. Indeed, given that our circuits are a bona-fide syntax, we can use structural induction.

5.1 Representation theorem

Kirchhoff's laws imply two global invariants are satisfied by all circuits. They can be elegantly stated and proved graphically, and imply a very useful result: all one-port circuits (those with one electrical input and one electrical output) are representable by an impedance as described in section 3. Thus the impedance calculus can be used with any one-port circuit that we encounter.

Proposition 7 (Relativity of potentials). A circuit constrains voltage differences, not absolute voltages. That is, adding the same voltage difference to all open wires of a circuit does not change its behavior.

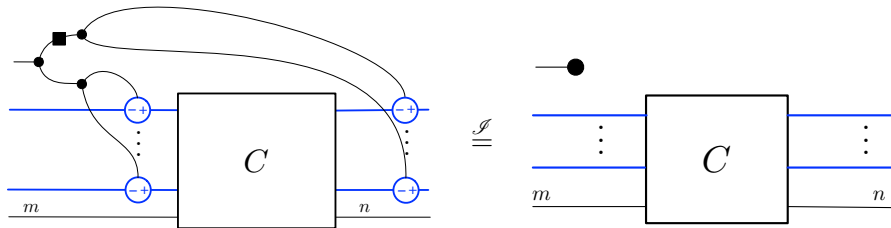

Proof. By induction on the structure of circuits. See appendix A.2 for more details. \square

Proposition 8 (Conservation of currents). The sum of the currents going into a circuit is equal to the sum of the outgoing currents.

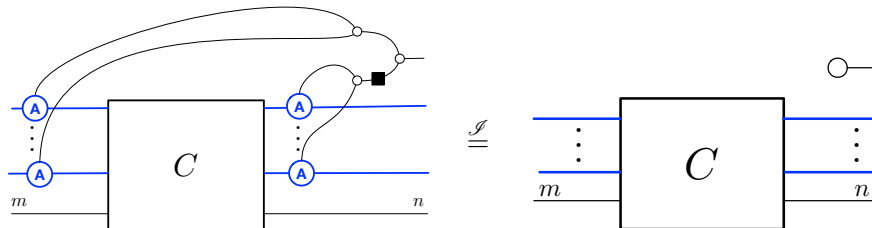

Proof. The proof proceeds exactly like the previous one, the only difference being an inversion of the colours, which does not affect the proof. \square

Theorem 9 (Representation theorem). A one-port circuit c is representable by an impedance:

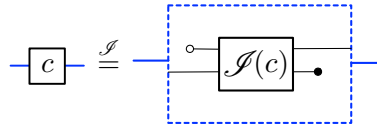

Proof. See appendix A.3. \square

5.2 Expressivity

A nervous reader might ask: given that we have liberally extended the basic calculus with arbitrary affine relations, via the information wires, do we risk modeling unphysical circuits? The answer is a surprising one: textbook elements are already expressive enough; they can express most affine relations.

We start by observing a surprising fact: adding *only* controlled sources and meters to the basic circuit elements (4) is *already* enough to build a circuit for most affine relations. Indeed, already we can build any GAA diagram on the information wires, since every generator can be constructed with a small circuit:

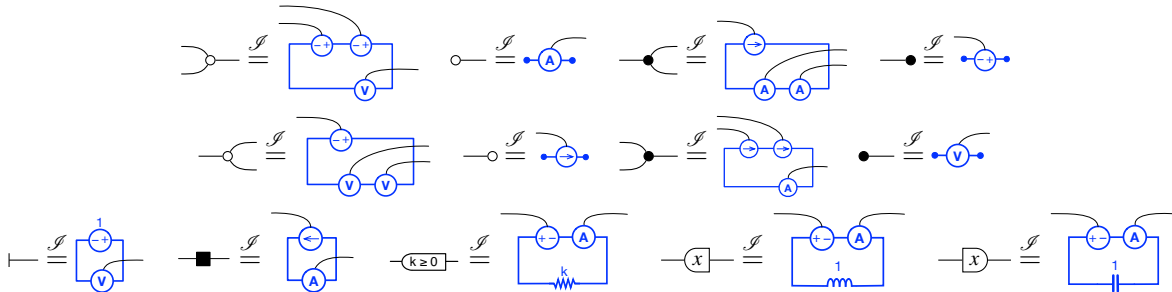

So, restricting to just information wires, we have the full expressivity of GAA. The following result characterises expressivity, also taking electrical wires into account.

Theorem 10 (Expressivity Theorem). Using only basic circuit elements (4), meters and controlled sources, we can express all affine relations that respect the invariants of propositions 7 and 8. This includes arbitrary affine relations on the information wires.

Proof. We sketched the main idea above. See Appendix A.4 for more details. \square

Now take a circuit with *no open information wires* made up of only basic elements, meters and sources. It is important to note that, although we can construct circuits equivalent to an arbitrary affine relations on the information wires, there is no *direct* way to copy information wires in a circuit. Since they cannot be copied, every meter is connected to exactly one source. This is essentially equivalent to adding textbook elements called *measurement-controlled sources*. The voltage-controlled current source is constructed as follows; other combinations (e.g. current-controlled voltage source) are similar.

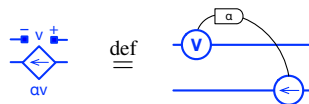

But this also means that, using only basic elements and measurement-controlled sources, we can build a circuit for any relation that respects the invariants (with no open information wires). There is no need to fear, therefore: textbook elements already capture enough affine relations.

5.3 Thévenin's theorem

Last but not least, we prove Thévenin's theorem, a well-known real-life example of compositional, diagrammatic reasoning. It allows one to replace a one-port circuit by a simpler, equivalent one. It can be seen both as a consequence and a stronger version of the representation theorem (Theorem 9).

Theorem 11 (Thévenin's theorem). If C is a one-port circuit made only of resistors and independent sources, then one of the following is true:

- (i) $\boxed{c} \stackrel{\cong}{=} \begin{array}{c} V_0 \\ \text{---} \oplus \text{---} \\ \text{---} \ominus \text{---} \\ \text{---} R \text{---} \end{array}$ for some V_0 and R ,
- (ii) $\boxed{c} \stackrel{\cong}{=} \begin{array}{c} I_0 \\ \text{---} \oplus \text{---} \\ \text{---} \ominus \text{---} \end{array}$ for some I_0 ,
- (iii) \boxed{c} denotes the empty relation.

Proof. See appendix A.5. □

6 Conclusion and future work

We extended existing compositional treatments of electrical circuit theory by including meters and controlled sources, enabling the analysis of closed circuits. We introduced the impedance calculus and demonstrated its power by solving simple circuits, and by proving a number of results—with the superposition theorem and Thévenin's theorem particularly notable, well-known examples from the corpus of standard electrical circuit theory. We also proved a representation theorem and characterised the expressivity of our circuit language, which is exactly that of circuits built up of standard textbook elements. With the syntactic approach, proofs are pleasingly simple, involving simple invariants and induction.

It is worth to step back and consider the bigger picture. We believe that the results herein are evidence that, while it is uncontroversial to say that electrical circuits are relational entities, they are better understood using relational *mathematics*. The benefit of not turning everything into matrices is that theorems are more crisp to state, the relationships and symmetries between various results become more immediately apparent, annoying “degenerate” cases are not ignored, and proofs become more satisfying.

There is much future work: while we could not include all of the theorems, we are confident of being able to replicate the majority of standard electrical circuit theory using these techniques. An obvious open question is how far can this approach take us? The passage from Graphical Linear Algebra to Graphical Affine Algebra allows to pass from passive circuits to non-passive circuits. The next, obvious challenge is to go beyond linearity: for example, if we were to satisfactorily capture the diode, we would get transistors, enabling the compositional analysis of arbitrary electronic circuits.

References

- [1] John C. Baez & Brendan Fong (2015): *A Compositional Framework for Passive Linear Circuits*. CoRR abs/1504.05625.
- [2] Filippo Bonchi, Joshua Holland, Dusko Pavlovic & Paweł Sobociński (2017): *Refinement for signal flow graphs*. In: *Concurrency Theory - 28th International Conference, (CONCUR 2017)*.
- [3] Filippo Bonchi, Robin Piedeleu, Paweł Sobociński & Fabio Zanasi (2019): *Graphical Affine Algebra*. In: *34th Annual ACM/IEEE Symposium on Logic in Computer Science (LICS)*, IEEE, Vancouver, BC, Canada, pp. 1–12, doi:10.1109/LICS.2019.8785877.

- [4] Filippo Bonchi, Paweł Sobociński & Fabio Zanasi (2017): *Interacting Hopf Algebras*. *Journal of Pure and Applied Algebra* 221(1), pp. 144–184, doi:10.1016/j.jpaa.2016.06.002.
- [5] Aurelio Carboni & R. F. C. Walters (1987): *Cartesian Bicategories I*. *Journal of Pure and Applied Algebra* 49, pp. 11–32.
- [6] Brandon Coya (2018): *Circuits, Bond Graphs, and Signal-Flow Diagrams: A Categorical Perspective*. Ph.D. thesis, University of California Riverside.
- [7] Charles A. Desoer & Ernest S. Kuh (1969): *Basic Circuit Theory*. McGraw-Hill, New York.

A Proofs

A.1 Lemma 1

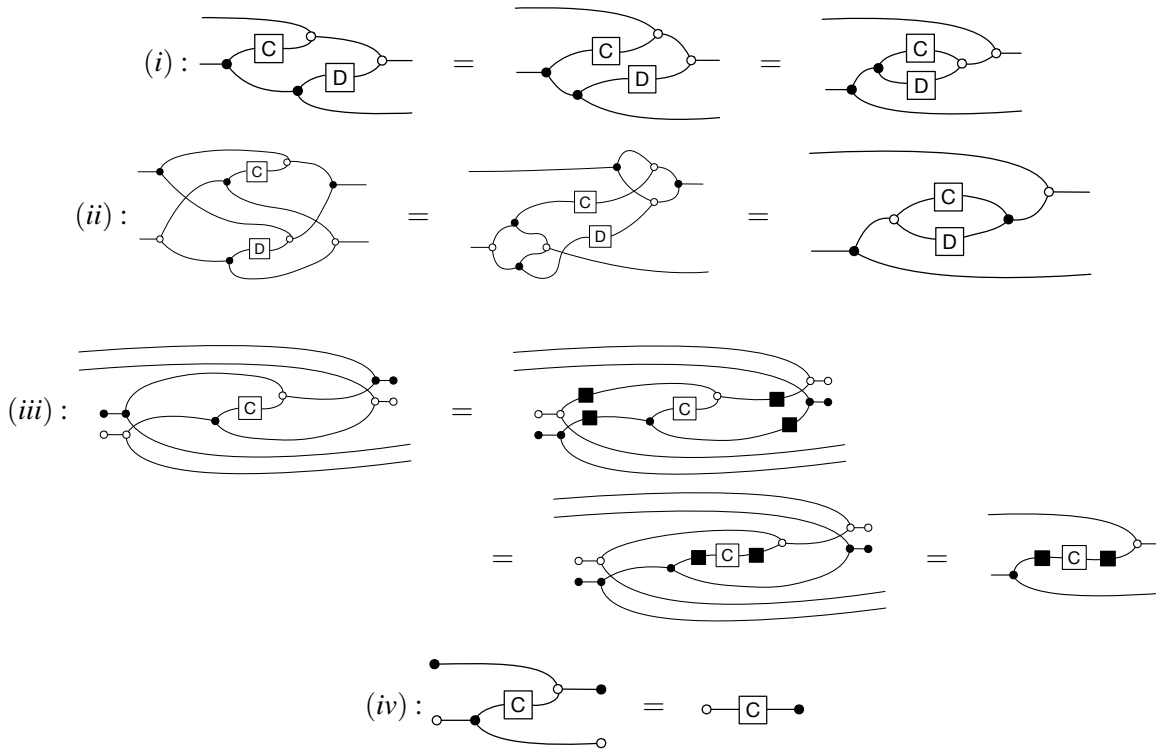

A.2 Relativity of Potentials (Proposition 7)

First, a lemma:

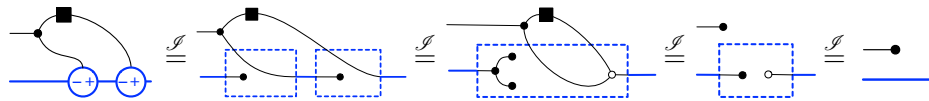

and of course, similarly

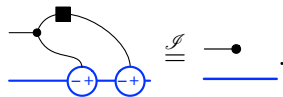

From this we can show that the property holds for circuit elements. The argument, which we show below for resistors, relies on the fact that circuit elements commute with voltage sources, which can be easily shown using the impedance calculus.

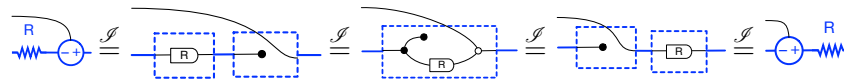

Given this, we have:

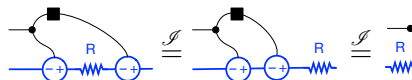

Voltage sources commute with junctions in the following sense:

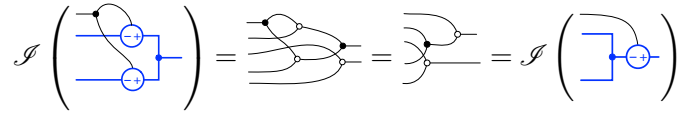

and so

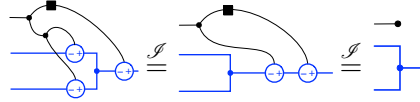

The remainder of the structure is similarly easy. What remains are the inductive cases. Parallel composition is immediate. Only sequential composition remains:

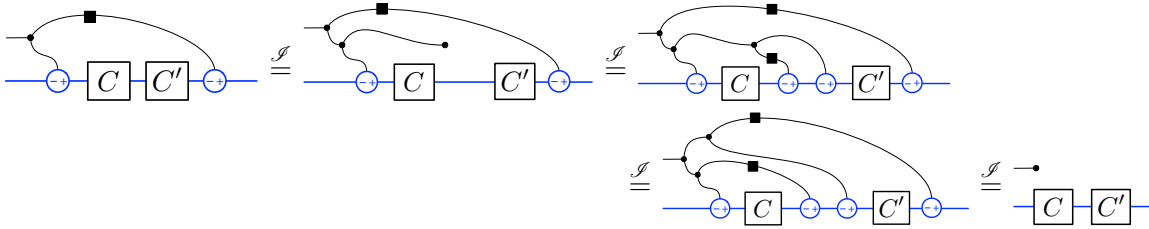

A.3 Proof of the Representation Theorem (Theorem 9)

Using the conclusions of Propositions 7 and 8 we have

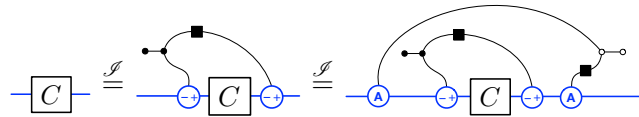

A simple calculation, therefore, confirms that:

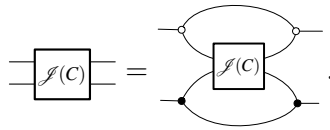

Now:

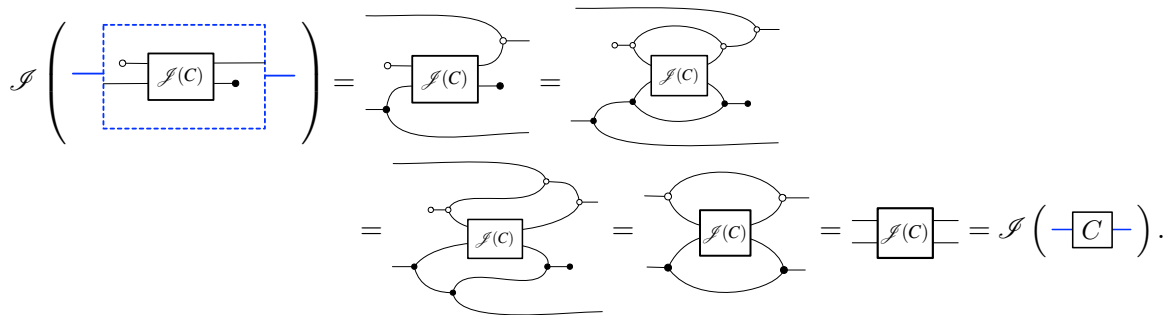

A.4 Proof of the Expressivity Theorem (Theorem 10)

First, we have observed that we can get all GAA generators on the info wires as follows:

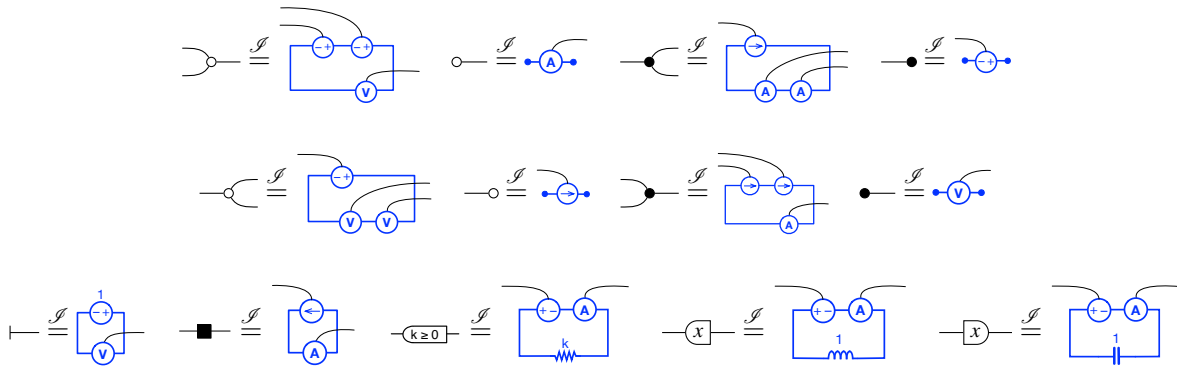

Using this we can get any invariant-preserving relation, as follows. Let $(\bullet^m \bullet^o, \bullet^n \bullet^p)$ be a circuit type, and let R be an affine relation with corresponding (co)arity:



Assume also that R respects the invariants of propositions 7 and 8 w.r.t. this type. First build a GAA diagram for R on the information wires using the generators shown above. From this, we build the following circuit:

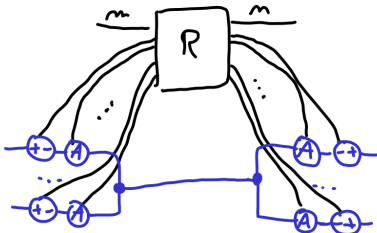

Its semantics is as follows, which by the two invariants is equal to R itself.

