

*MOBILE HEALTH
AND
GENERATIVE AI*

MOBILE HEALTH COURSE

TONG XIA

TX229@CAM.AC.UK



UNIVERSITY OF
CAMBRIDGE

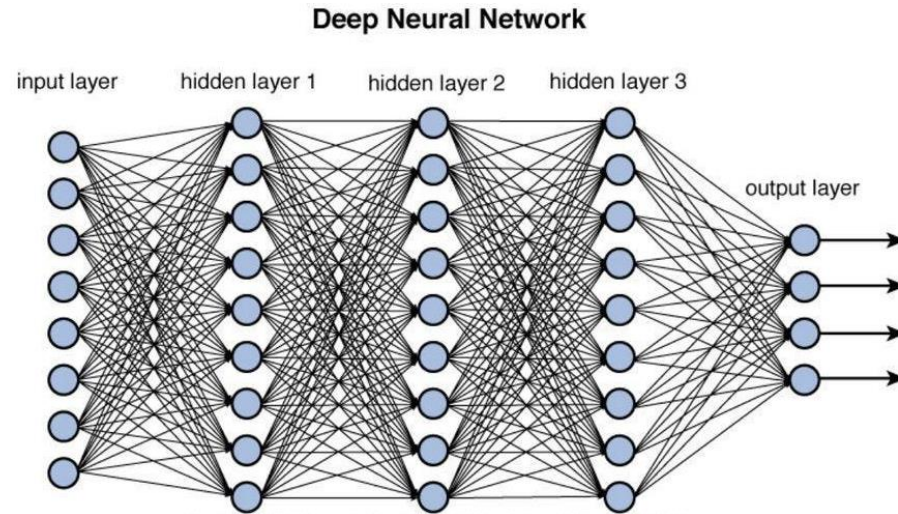
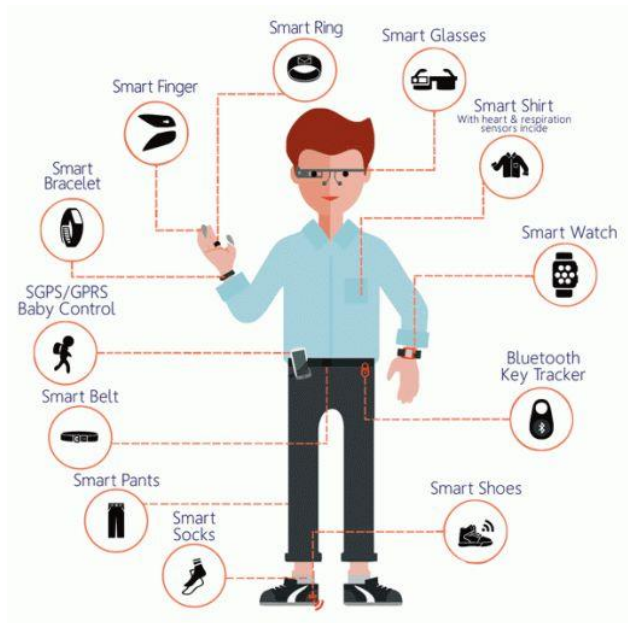

Figure 12.2 Deep network architecture with multiple layers.

The widespread of mobile and wearable devices

The power of machine learning and deep learning models

Automated health monitoring and diagnostics

CHALLENGES

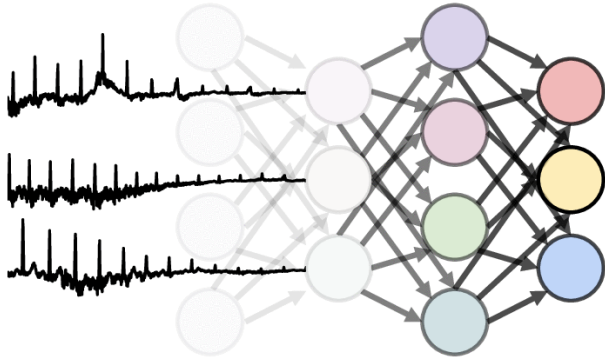

DL models are data hungry

- Transfer learning
 - Reduce the need of training data
- Semi-supervised and self-supervised learning
 - Reduce the need of annotation

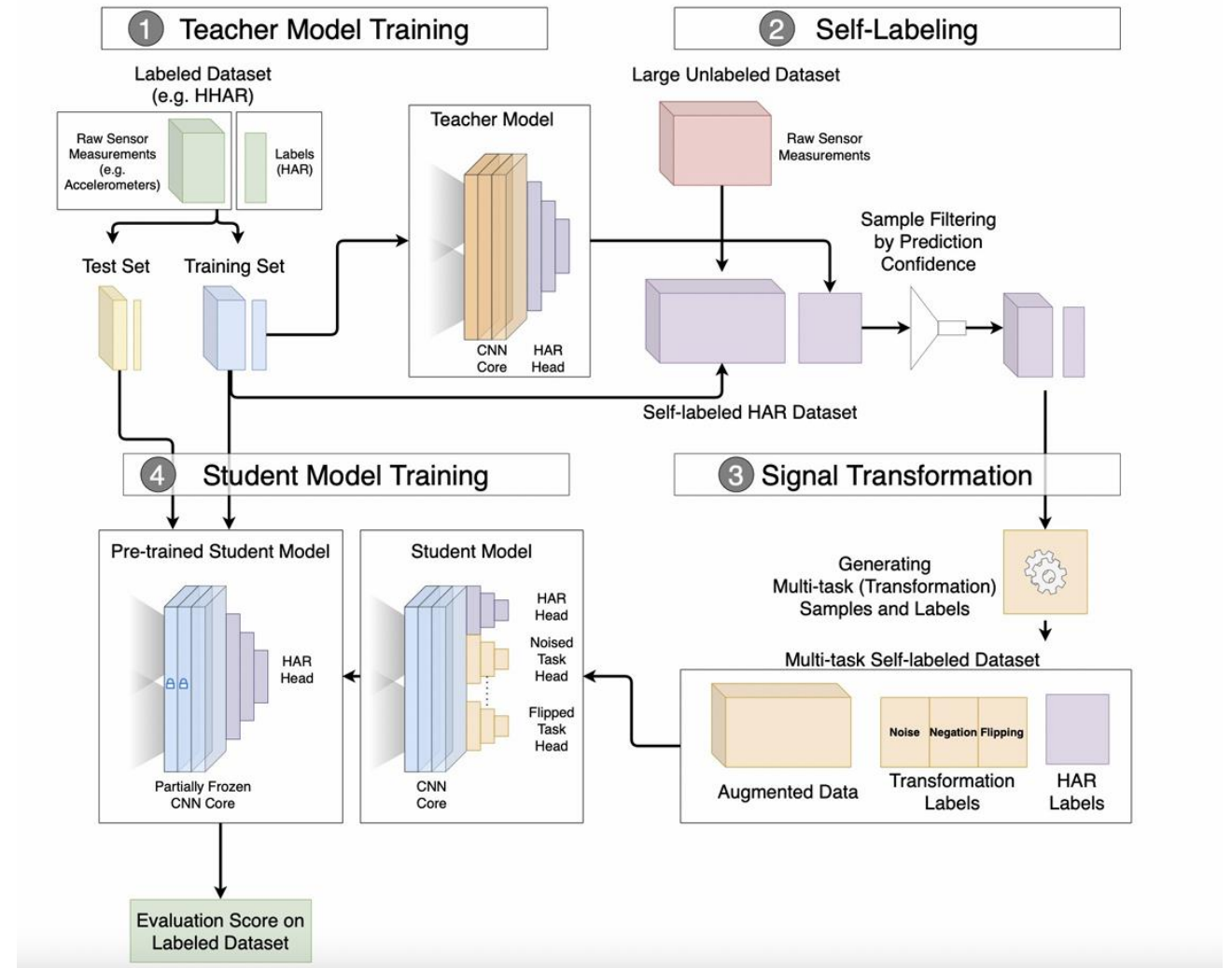

GENERATIVE AI

Generative artificial intelligence (generative AI, GenAI or GAI) is artificial intelligence capable of generating text, images or other data using generative models. Generative AI models learn the patterns and structure of their input training data and then generate new data that has similar characteristics.

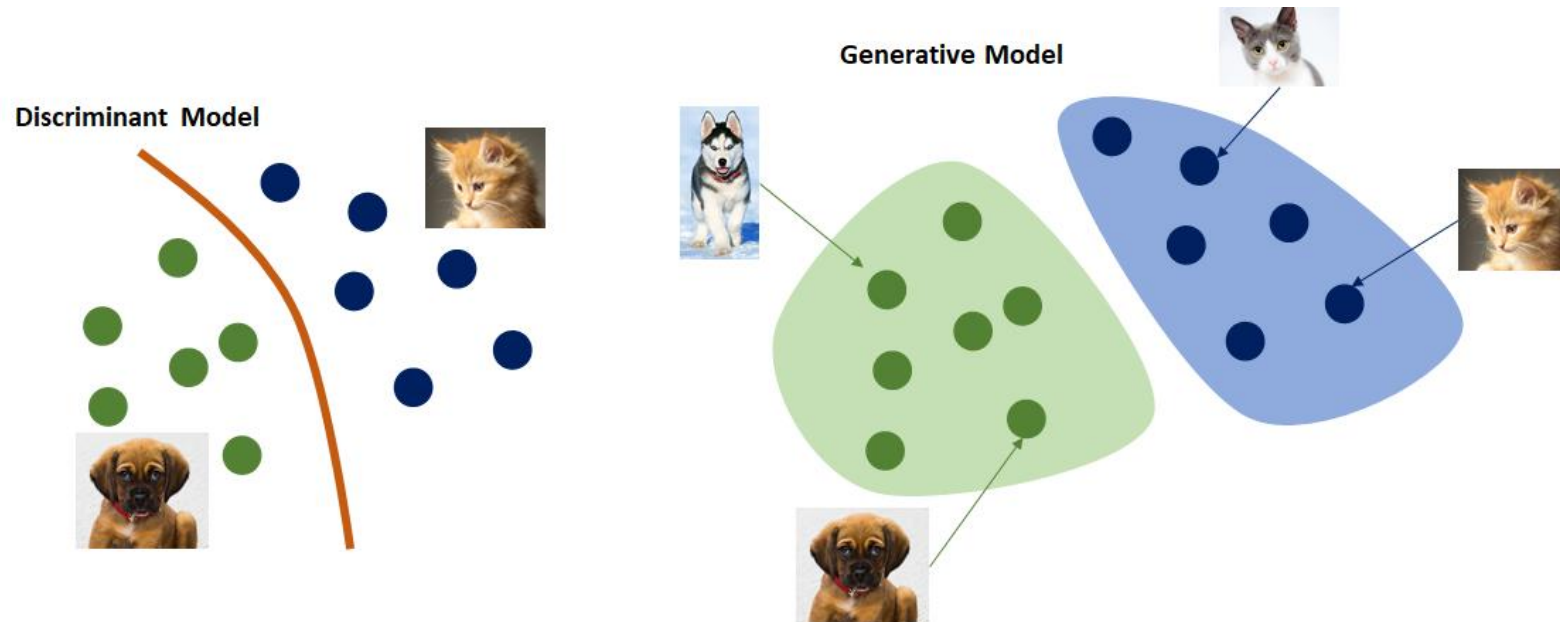

- **Data generation model**
 - VAE, GAN, Diffusion
 - Examples
- Transformer based generative model
 - Framework
 - Examples
- Foundation model for bio-signals
 - Examples

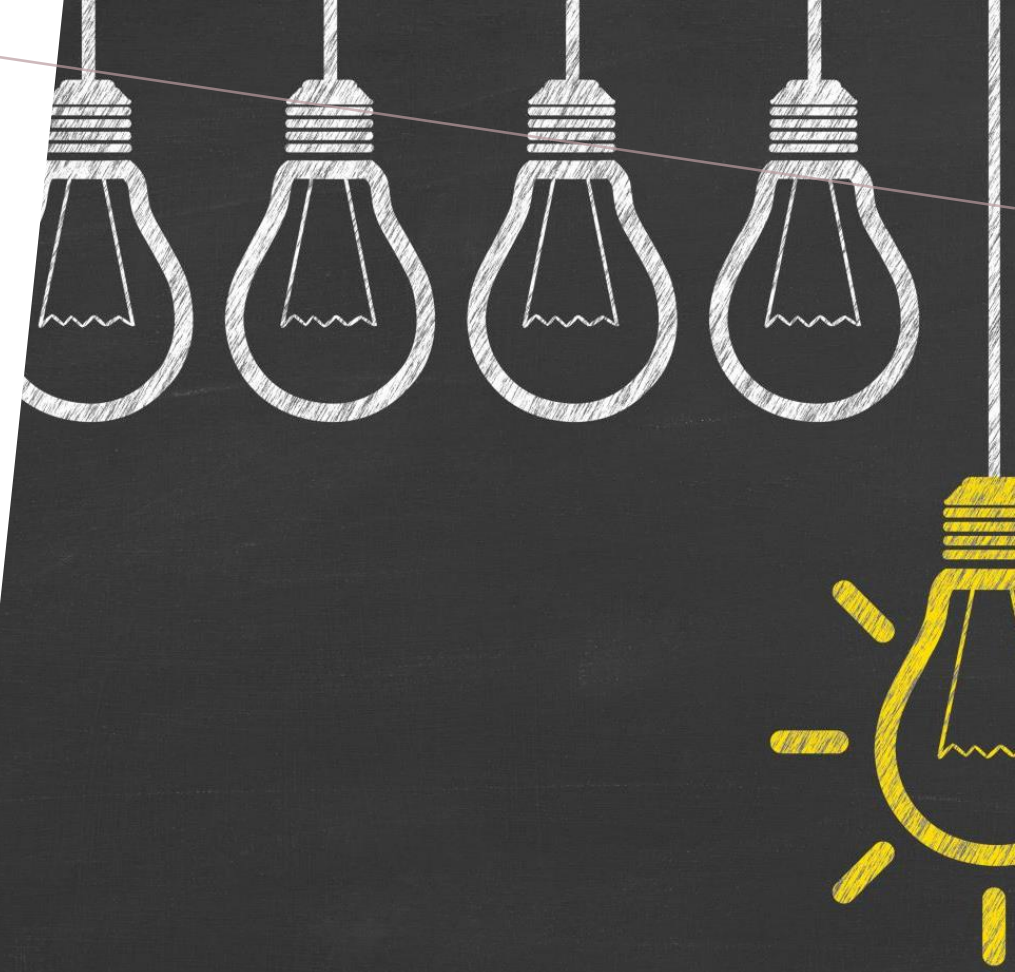

Generative model - VAE

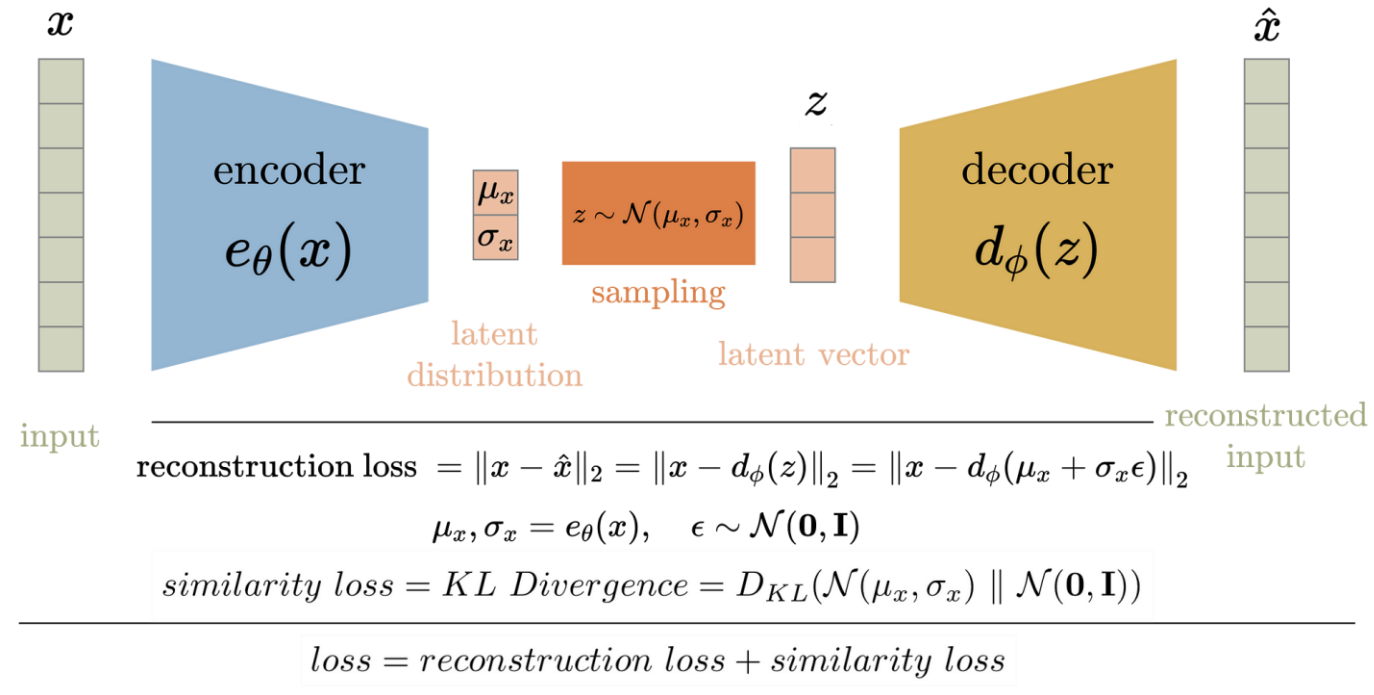

Generative model - GAN

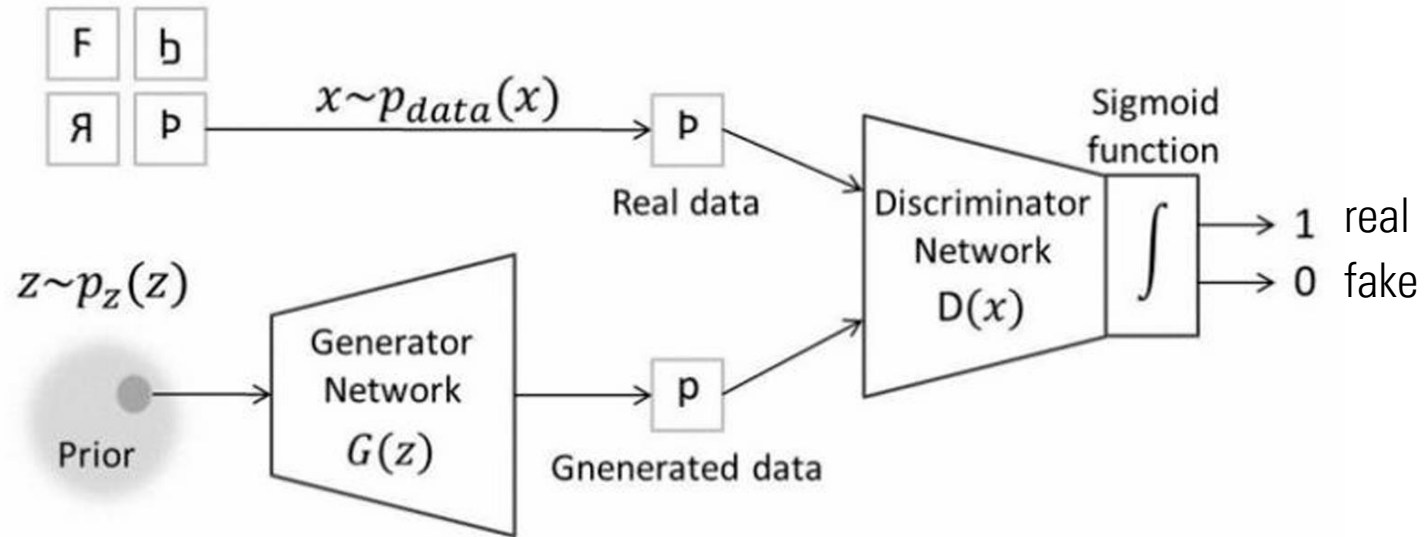

Train iteratively:

- Step 1: Freeze $D(x)$ to update $G(z)$
- Step 2: Freeze $G(x)$ to update $D(x)$

Generation:

- Step 1: Sample z
- Step 2: Use $G(z)$ to generate p

Generative model – Diffusion Models

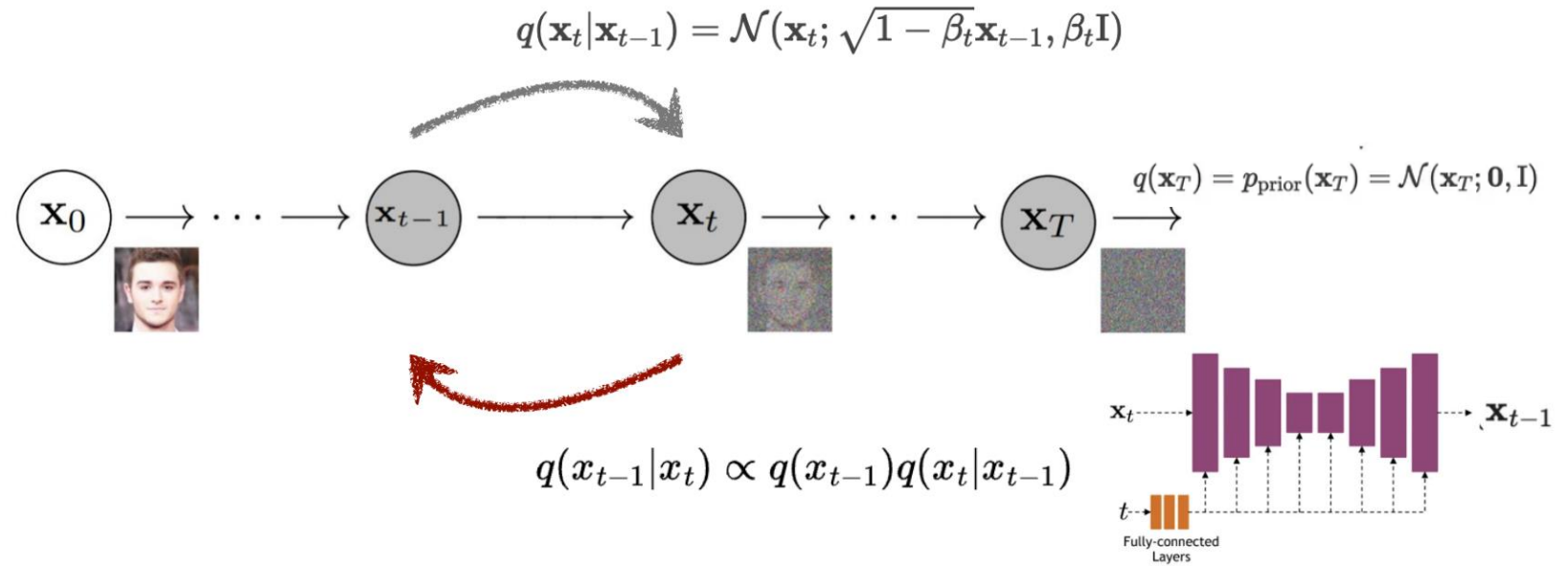

- Forward diffusion process: Iteratively inject given noise to the data
- Reverse diffusion process: Intractable but can be approximated by a UNet

Generative model – Diffusion Models



Scaling transformers for video generation

Sora is a diffusion model^{21,22,23,24,25}; given input noisy patches (and conditioning information like text prompts), it's trained to predict the original “clean” patches. Importantly, Sora is a diffusion *transformer*.²⁶ Transformers have demonstrated remarkable scaling properties across a variety of domains, including language modeling,^{13,14} computer vision,^{15,16,17,18} and image generation.^{27,28,29}



A comparison

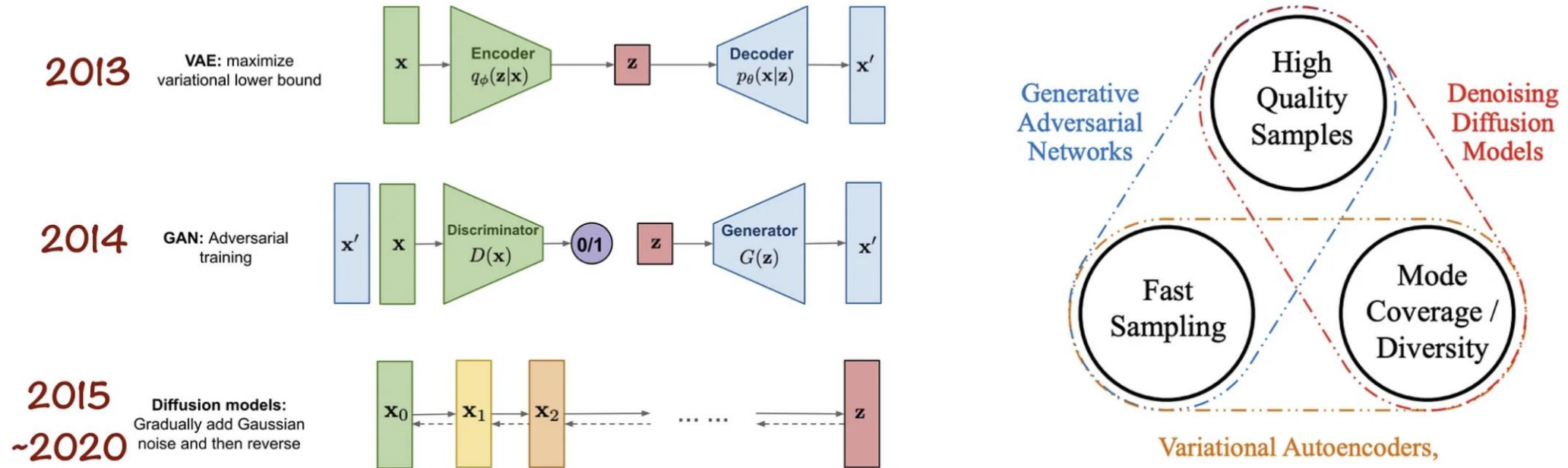

- Data quantity augmentation: enabling more data samples for downstream tasks
- Data quality enhancement:
 - Removing noise/artefacts
 - Imputing the missenses in the data
 - Privacy-preserving data sharing

Recommend reading: Cao, Hanqun, et al. "A survey on generative diffusion models." *IEEE Transactions on Knowledge and Data Engineering* (2024).

Example 1 : Diffusion model-based EEG generation

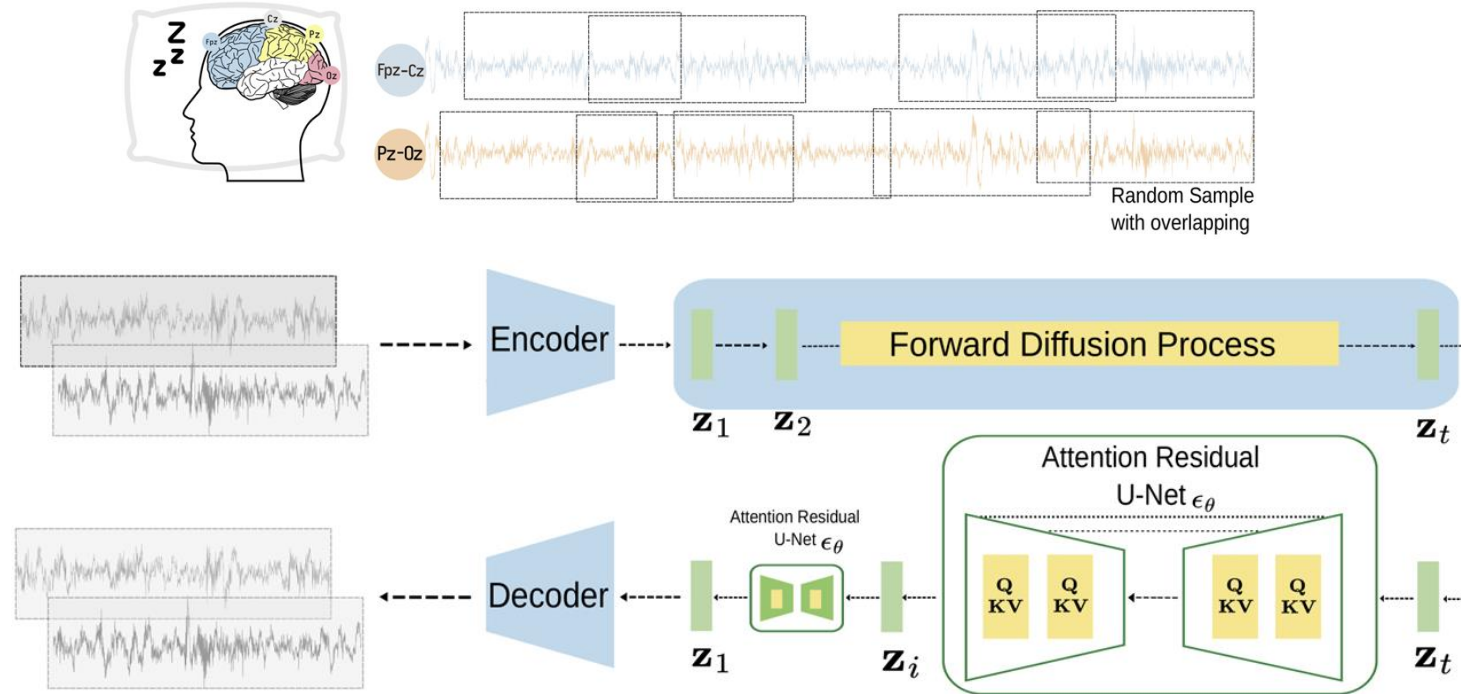

Table 1: Quantitative evaluation

Dataset	FID ↓		
	LDM	LDM _{spec}	Real
Sleep EDFx	11.933	0.308	0.015
SHHS _h	0.936	0.168	0.086

FID: Fréchet Inception Distance

$$\min \sum l_{\text{recons}}(\mathbf{x}, \hat{\mathbf{x}}) + l_{\text{adv}}(\mathbf{x}, \hat{\mathbf{x}}) + l_{\text{kl}}(\mathbf{z}_\mu, \mathbf{z}_\sigma) + l_{\text{spec}}(\mathbf{x}_i, \hat{\mathbf{x}}),$$

Temporal dynamics reconstruction

Spectral feature similarity



*TRANSFORMER
BASED
GENERATIVE
MODEL*

Log in

Sign up

SE

Hi



Hello! How can I help you today?
If there's something you need help with,
I'd love to learn more about it and
would like to learn more about it.
I'm here to assist you with any questions
you may have.

Transformer

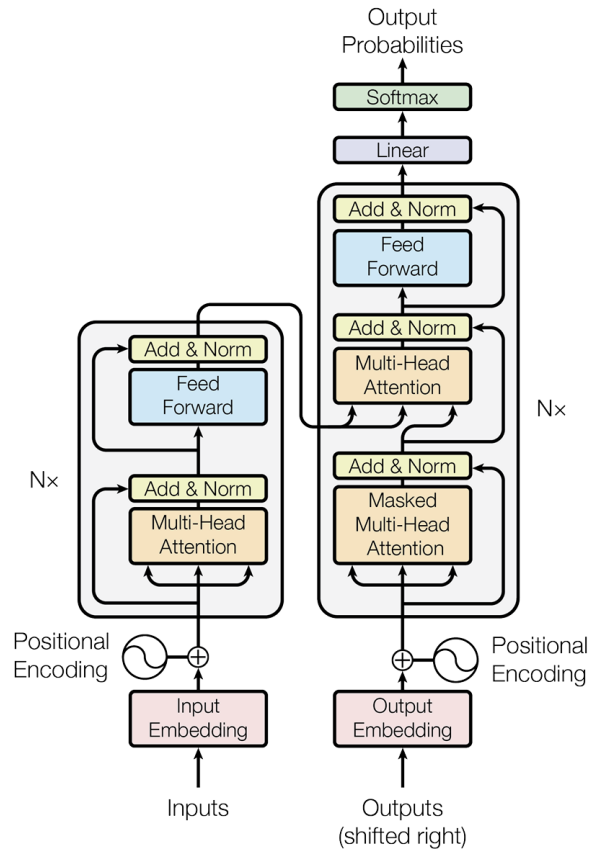
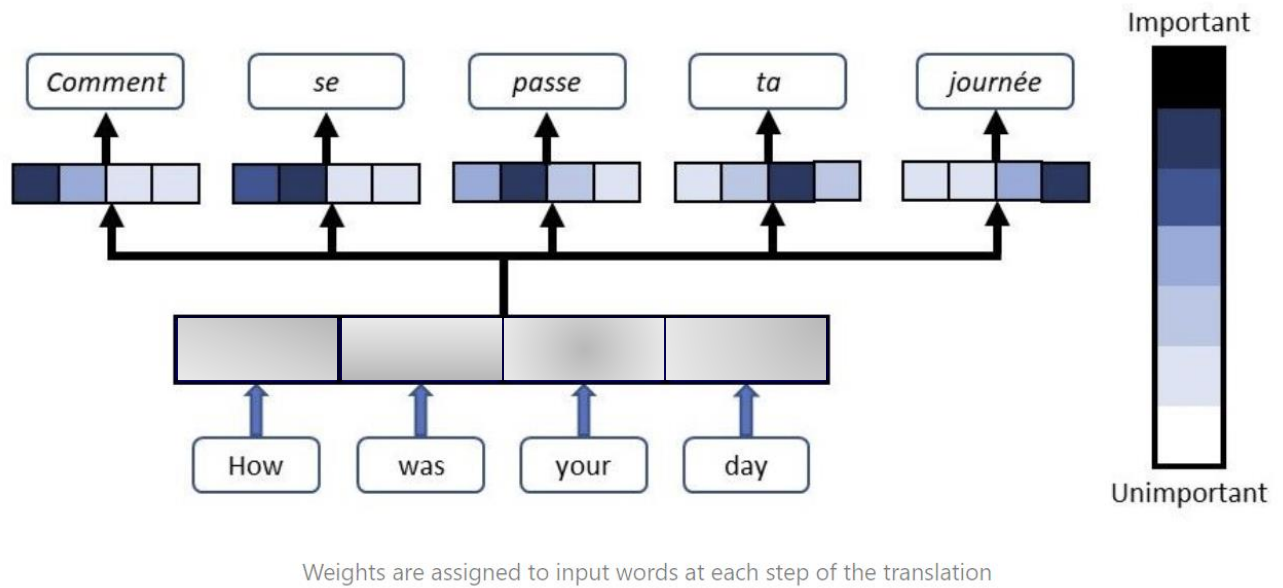

Figure 1: The Transformer - model architecture.

What is Attention?



Generative pre-trained Transformer (GPT)

Stage I: Unsupervised pre-training

Large-scale unlabelled data

Given an unsupervised corpus of tokens $\mathcal{U} = \{u_1, \dots, u_n\}$, we use a standard language modeling objective to maximize the following likelihood:

$$L_1(\mathcal{U}) = \sum_i \log P(u_i | u_{i-k}, \dots, u_{i-1}; \Theta) \quad (1)$$

Model size is important!

Stage II: Supervised training

Small-scale labelled data

We assume a labeled dataset \mathcal{C} , where each instance consists of a sequence of input tokens, x^1, \dots, x^m , along with a label y . The inputs are passed through our pre-trained model to obtain the final transformer block's activation h_i^m , which is then fed into an added linear output layer with parameters W_y to predict y :

$$L_2(\mathcal{C}) = \sum_{(x,y)} \log P(y | x^1, \dots, x^m). \quad (4)$$

Emergent abilities of large language models (LLMs)

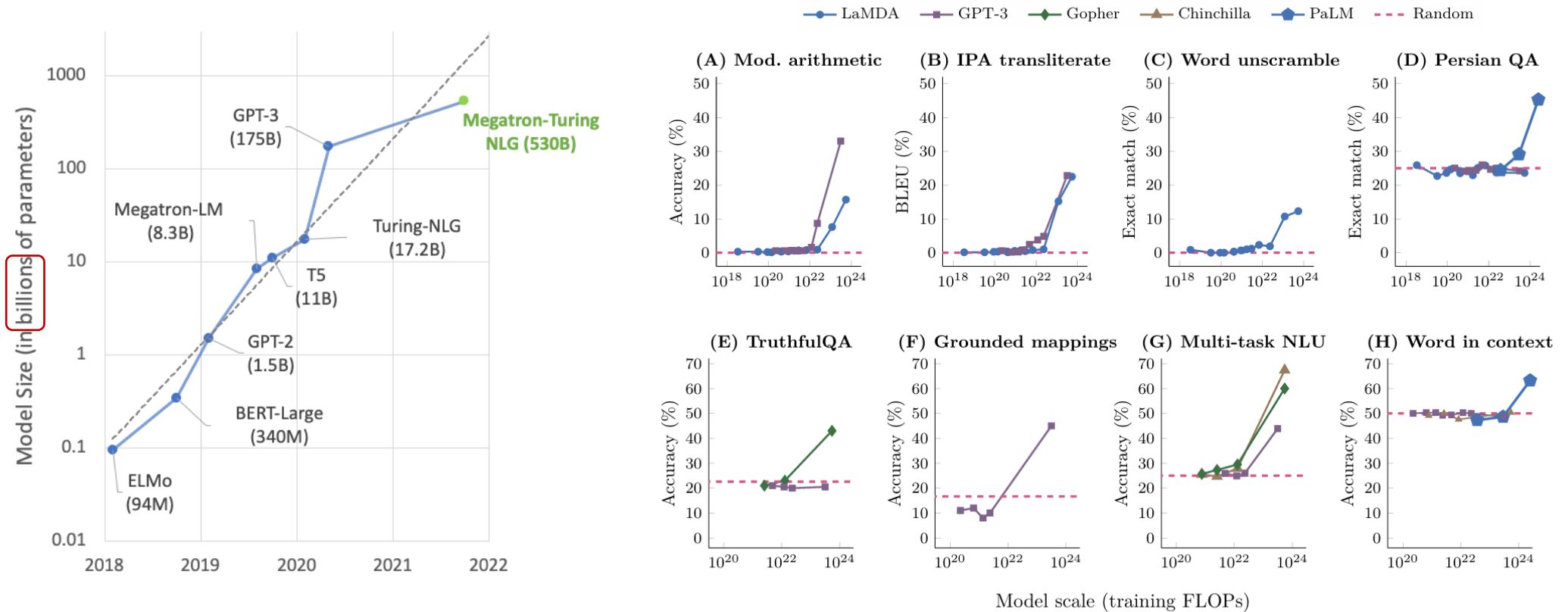

Figure 2: Eight examples of emergence in the few-shot prompting setting. Each point is a separate model.

Wei, Jason, et al. "Emergent abilities of large language models." *arXiv preprint arXiv:2206.07682* (2022).

Fine-tuning LLMs

A key to success of ChatGPT

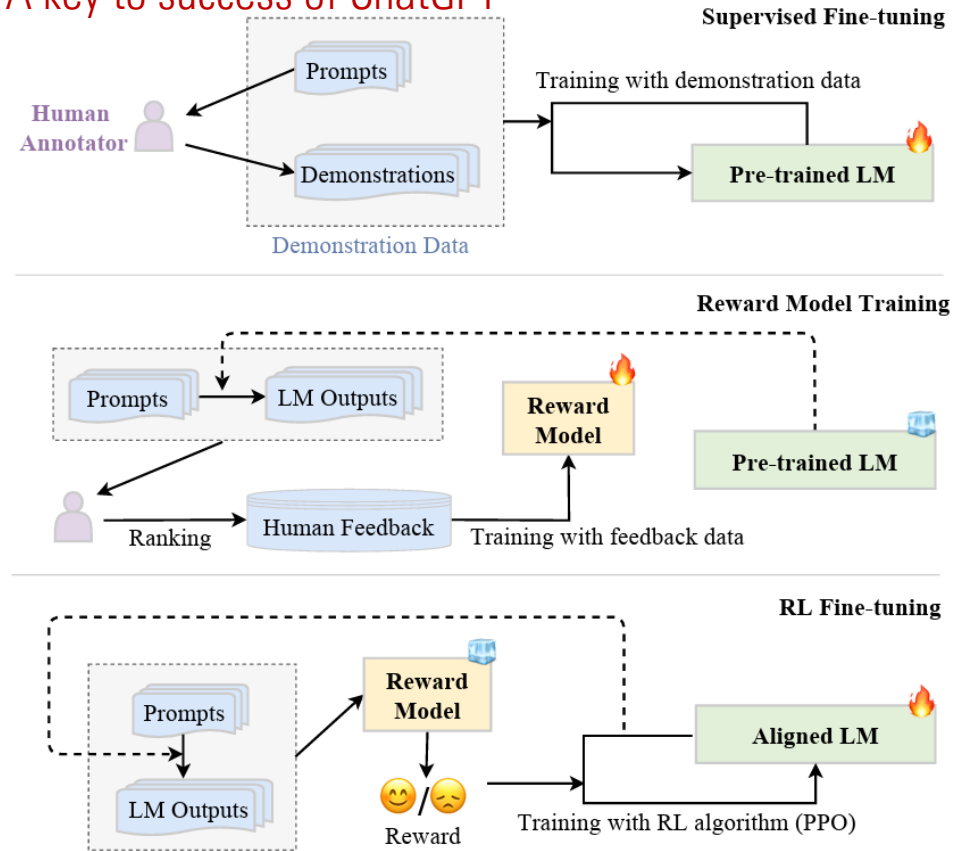

Fig. 12: The workflow of the RLHF algorithm.

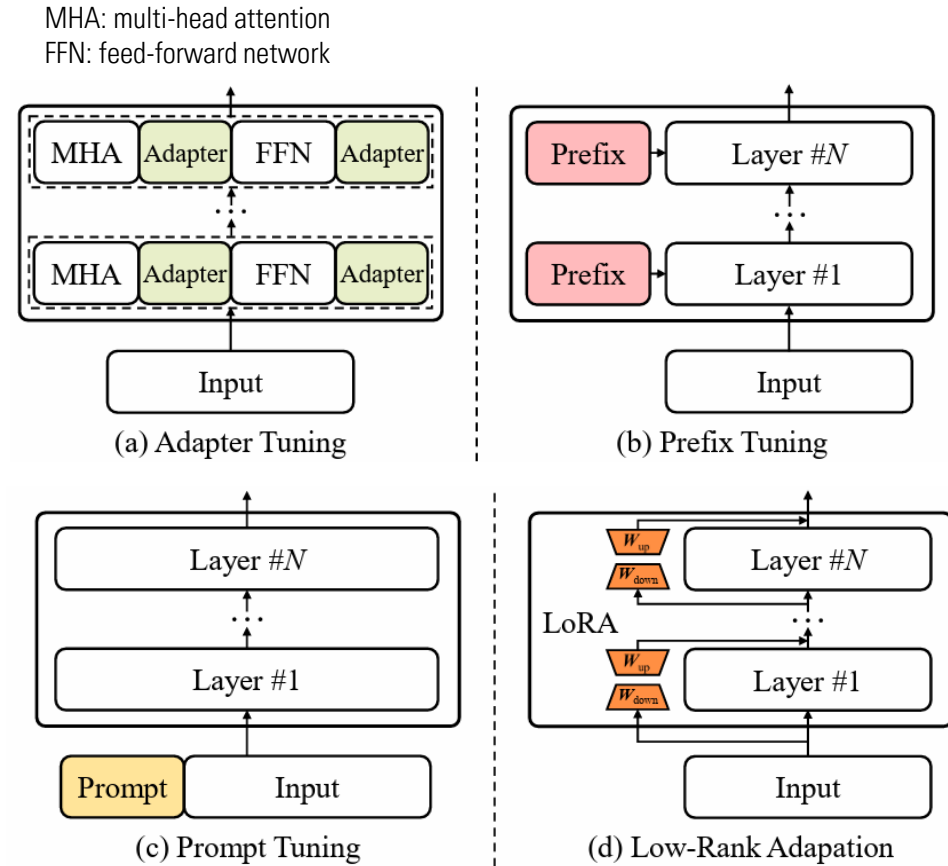

Fig. 13: An illustration of four different parameter-efficient fine-tuning methods.

Fine-tuning the entire model is not practical for most applications

Example 2: Medical large language models

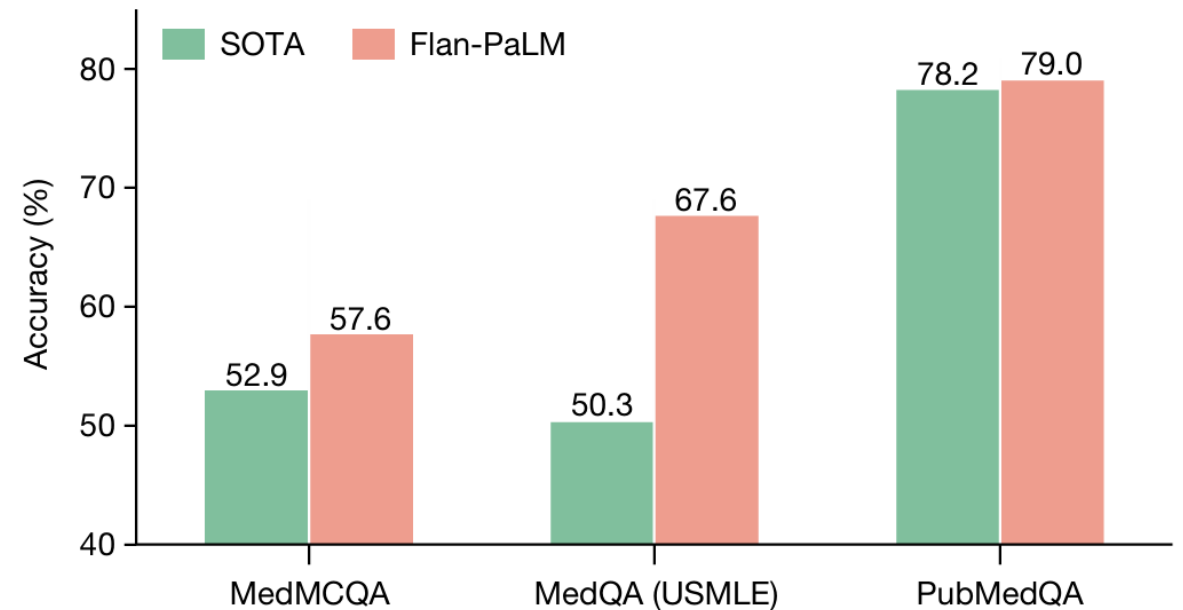
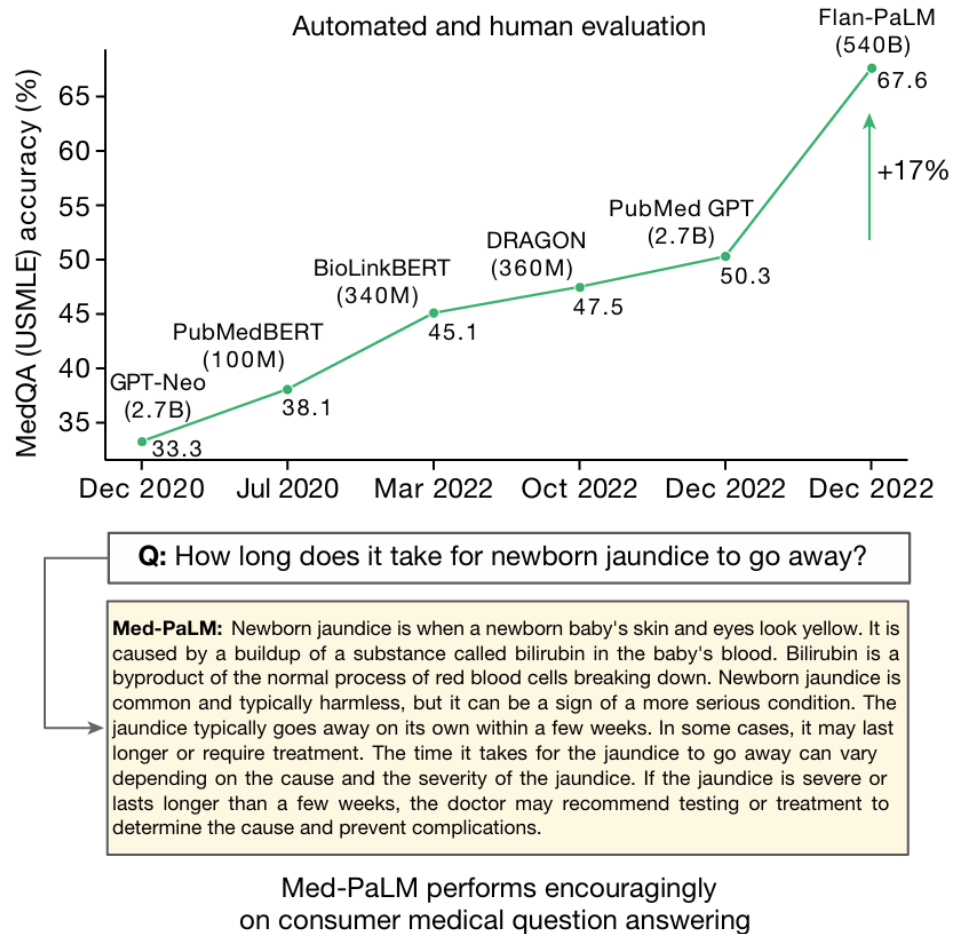

Fig. 2 | Comparison of our method and prior state of the art. Our Flan-PaLM 540B model exceeds the previous state-of-the-art performance (SOTA) on MedQA (four options), MedMCQA and PubMedQA datasets. The previous state-of-the-art results are from Galactica²⁰ (MedMCQA), PubMedGPT¹⁹ (MedQA) and BioGPT²¹ (PubMedQA). The percentage accuracy is shown above each column.



*HOW DO LLMS PERFORM ON
MOBILE HEALTH TASKS?*

Example 3: Large language models are few-shot learners

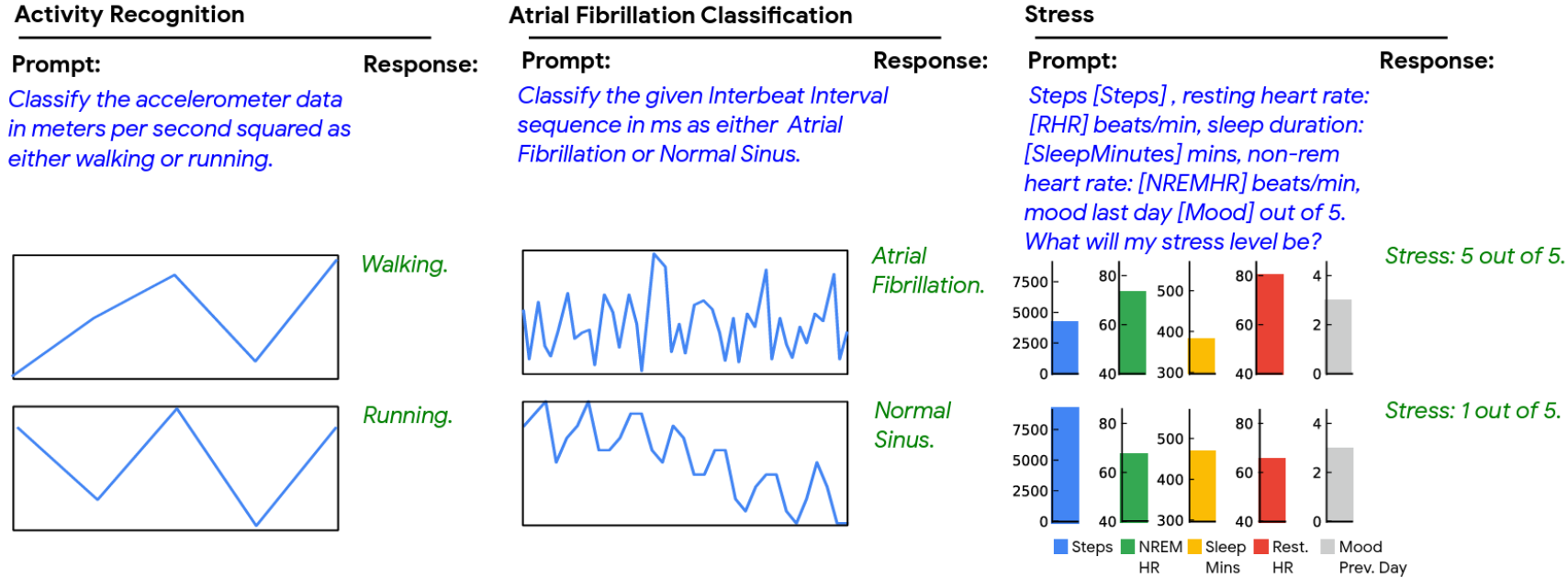

Figure 1: **Examples of question-answer pairs for our health tasks.** In the prompts, data were represented numerically rather than graphically.

Example 4: Large language models are few-shot learners

Input: "Classify the following accelerometer data in meters per second squared as either walking or running: 0.052,0.052,0.052,0.051,0.052,0.055,0.051,0.056,0.06,0.064"
Label: "Running"

Table 2: **Results.** Comparison of performance between prompt-tuned LLMs (w/ Context-Inclusive Prompts) and supervised neural network training across all consumer health tasks.

Topic	Task	Metric	Supervised Baseline			LLM with Context			% Improvement
			3-Shot	10-Shot	25-Shot	3-Shot	10-Shot	25-Shot	
Cardio	HRs to Average HR	MAE ↓ (beats/min)	3.41	1.37	1.08	6.00	2.49	1.06	+1.90%
	IBIs to HR	MAE ↓ (beats/min)	34.0	20.0	19.8	12.3	5.87	5.01	+74.7%
	IBIs to A.Fib.	Accuracy ↑ (%)	52.5	72.5	75.0	85.0	75.0	89.0	+19.7%
	IBIs to Sinus B.	Accuracy ↑ (%)	88.0	86.0	86.0	81.0	79.0	92.0	+7.00%
	IBIs to Sinus T.	Accuracy ↑ (%)	56.0	53.0	61.0	65.0	82.0	88.0	+44.3%
Activity	IMU Activity	Accuracy ↑ (%)	56.0	60.0	64.0	62.0	80.0	85.0	+32.8%
Metabolic	Calories	MAE ↓ (calories)	185	97	89	106	77	48	+46.1%
MHealth	Fitbit to Stress	Accuracy ↑ (%)	37.5	70.5	80.0	72.5	71.5	82.5	+3.10%
	Fitbit to PHQ	Accuracy ↑ (%)	51.0	52.0	53.0	49.0	59.0	69.0	+30.2%

Tokenizer for natural language

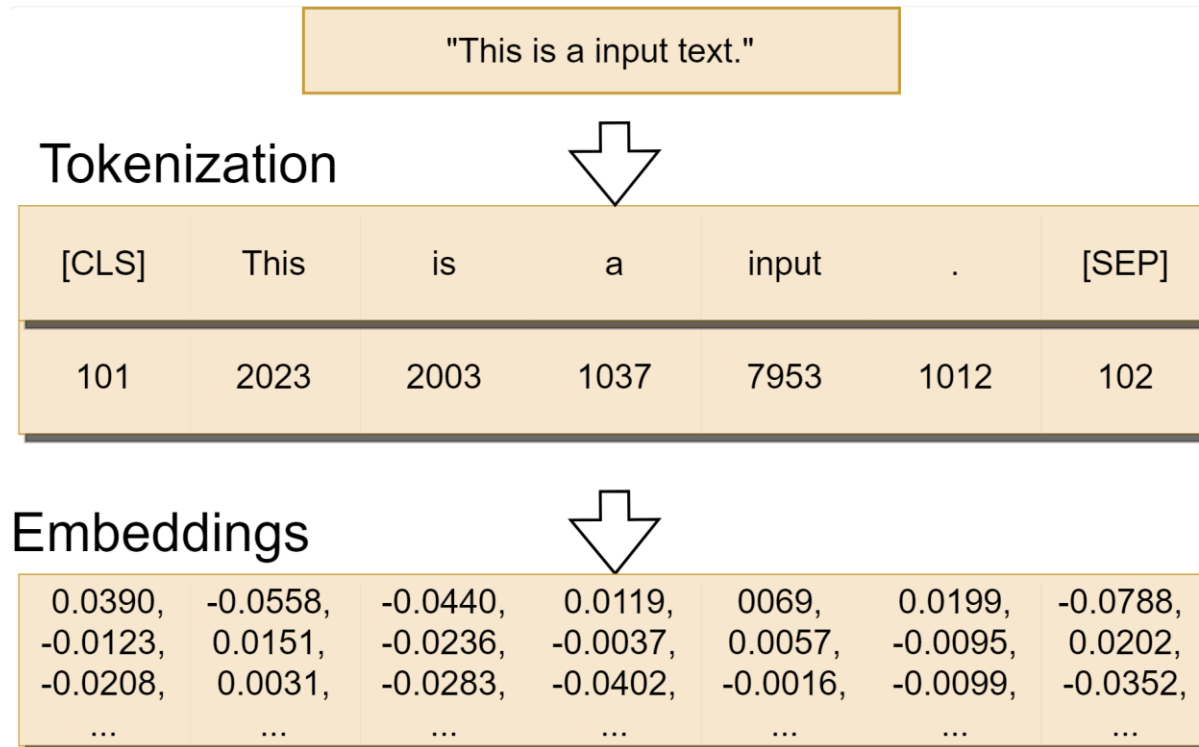

Q: HOW TO REPRESENT TEMPORAL DATA?

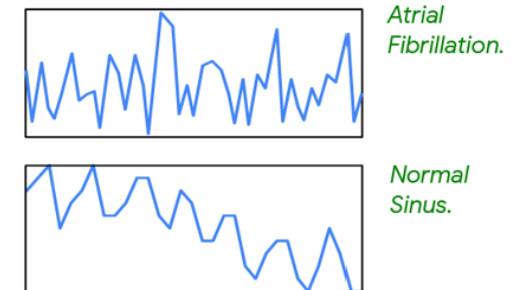

Example 4: Time-LLM: Time series forecasting by reprogramming large language models

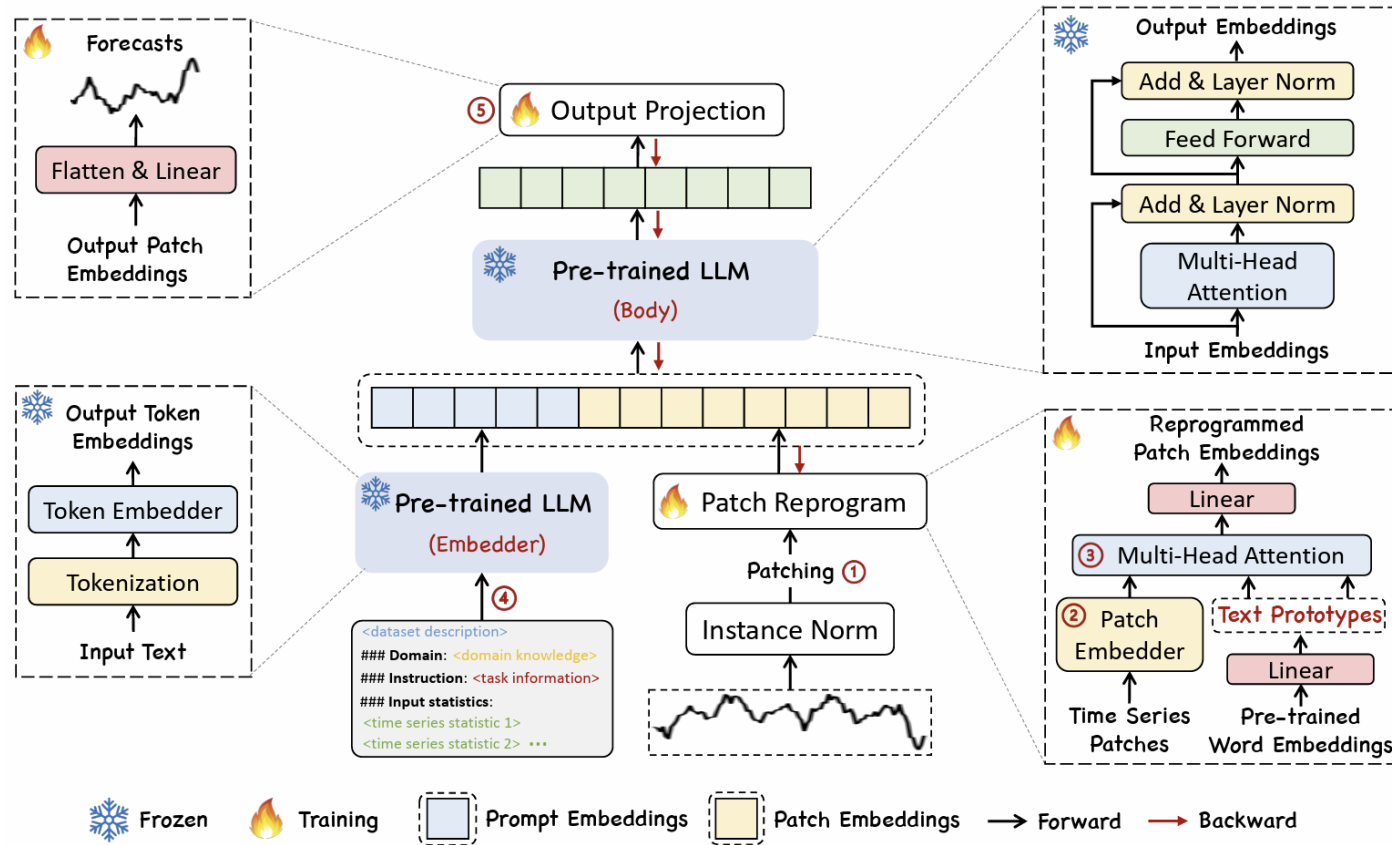



*IS THERE ANY
PHYSIOLOGICAL DATA SPECIFIC
FOUNDATION MODEL?*

Example 5: Large-scale training of foundation models for wearable bio-signals



Data used to develop this foundation model

	PPG	ECG
Number of participants	141,207	106,643
Number of segments	19,854,101	3,743,679
Average number of calendar days per participant	92.54	23.27
Total dataset time span (days)	890	1,240

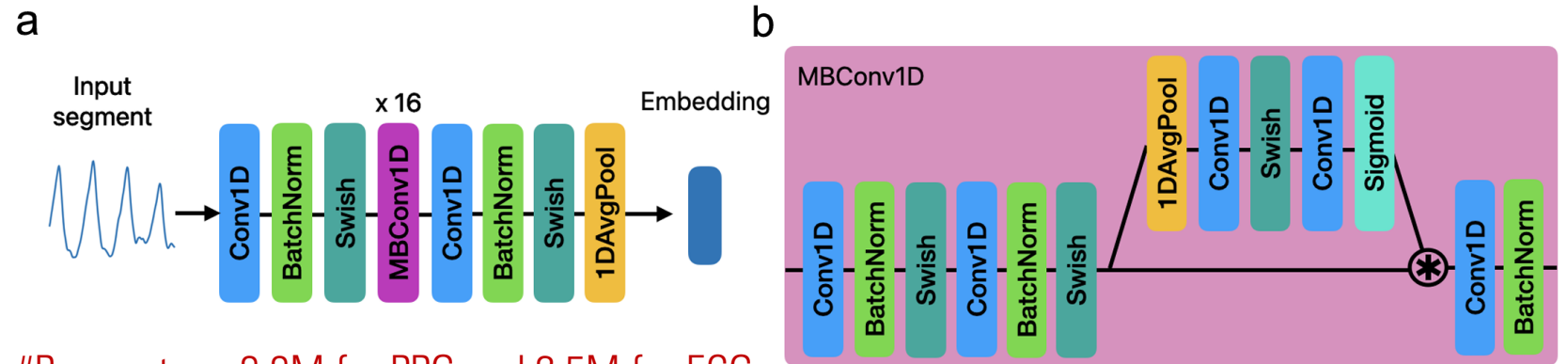

#Parameters: 3.3M for PPG and 2.5M for ECG

Figure 4: Our EfficientNet-style encoder architecture, adapted from (Tan & Le, 2020) for time-series

Example 5: Large-scale training of foundation models for wearable bio-signals

SSL training:

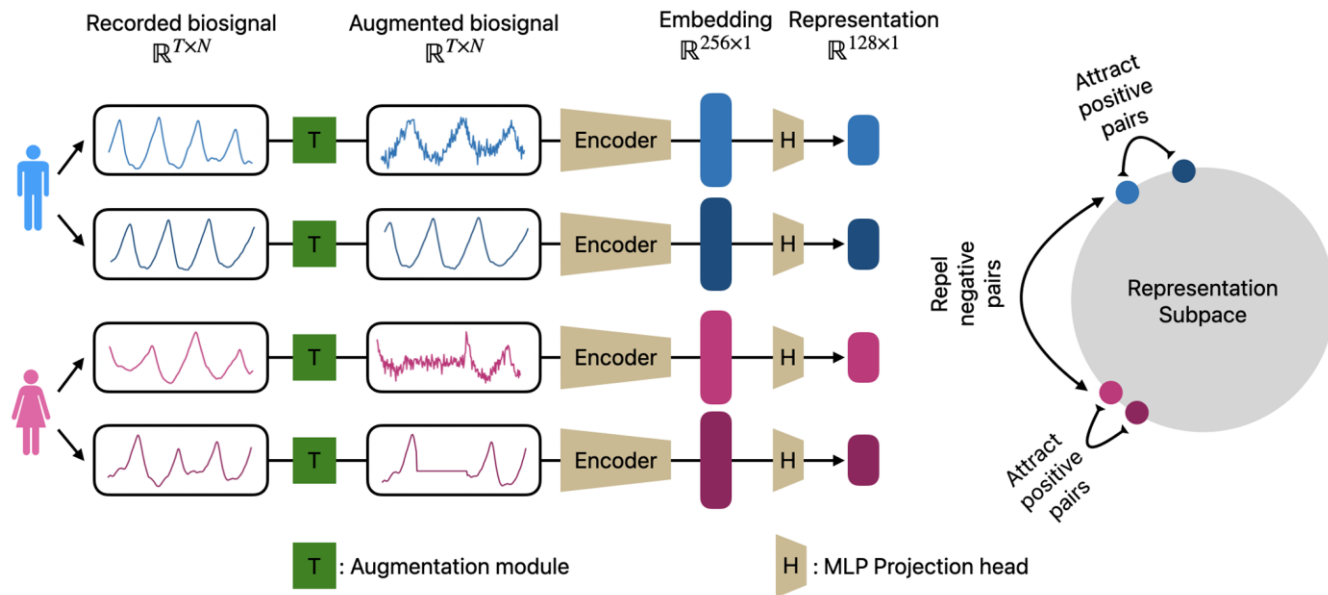

Results on downstream tasks:

Prediction task	PPG	
	AUC (pAUC) \uparrow	MAE \downarrow
Age classification	0.976 (0.907)	-
Age regression	-	3.19
BMI classification	0.918 (0.750)	-
BMI regression	-	2.54
Sex classification	0.993 (0.967)	-

Prediction task	ECG	
	AUC (pAUC) \uparrow	MAE \downarrow
Age classification	0.916 (0.763)	-
Age regression	-	6.33
BMI classification	0.797 (0.612)	-
BMI regression	-	3.72
Sex classification	0.951 (0.841)	-

SUMMARY

Limited labelled data is an obstacle for high-performing DL

- Now we have:
 - Data generation models for data augmentation
 - Pre-trained large (language) models for downstream tasks
 - SSL-empowered foundation models for bio-signals
- Open questions:
 - Evaluation of fine-tuning methods and the foundation models and on mobile health applications
 - Multi-modality foundation models...



FUTURE



Digital health twin



LLMs for health reasoning

THANK YOU!

Tong Xia
tx229@cam.ac.uk

